



FERVI

42

fervi.com

**THE CATALOGUE FOR MRO PROFESSIONALS
[MAINTENANCE, REPAIR AND OPERATIONS]**

100 - MACHINERY

150 - MACHINERY ACCESSORIES

200 - CUTTING TOOLS

300 - MEASURE

400 - HARDWARE

450 - GENERAL TOOLS

500 - ABRASIVES

p.004  LATHES, MILLS
AND DRILLS

p.059  METAL WORKING
MACHINERY

p.076  WOOD WORKING
MACHINERY

p.096  MACHINERY
FOR FINISHING

p.115  PRESSES AND
HYDRAULIC PUMPS

p.120  CAR AND MOTORCYCLE
WORKSHOP

p.129  LIFTING AND
HANDLING

p.142  MACHINE
VICES

p.147  TABLES AND
DIVIDERS

p.155  CHUCKS AND
LIVE CENTERS

p.170  TOOL POSTS AND
TOOL HOLDERS

p.172  MACHINERY
ACCESSORIES

p.175  TOOLS FOR TURNING
AND MILLING

p.194  INSERTS, LATHE
TOOLS AND TOOL BITS

p.208  DRILLS AND
HOLE SAWS

p.233  MILLING
TOOLS

p.240  TAPS
AND DIES

p.245  THREAD
REPAIR

p.258  BANDSAW BLADES
AND SAW BLADES

p.262  CALIPERS, HEIGHT
GAUGE AND RULERS

p.268  DIAL INDICATORS

p.272  MICROMETERS

p.274  GAUGE BLOCKS, SCREW GAUGE
AND HOLE PLAIN GAUGE

p.277  MEASURING
TOOLS

p.287  PRECISION TAPES, LEVELS
AND GONIOMETERS

p.291  ANALOGIC AND
DIGITAL METERS

p.301  SCALES

p.306  BLACK
EDITION

p.314  WRENCHES

p.334  SOCKET WRENCHES AND
SCREW EXTRACTORS

p.358  SCREWDRIVERS AND
HAND RIVETERS

p.373  PLIERS, HAMMERS,
FILES AND CHISELS

p.388  UTILITY KNIVES, DEBURRING
AND CUTTING TOOLS

p.398  SETS AND
FASTENINGS

p.404  WORKSHOP
FURNITURE

p.422  TOOL CABINETS
AND TOOL SETS

p.448  BENCH VICES,
CLAMPS AND ANVILS

p.453  PNEUMATIC

p.470  SOLDERINGS, HOT AIR
GUNS AND GLUE GUNS

p.474  EQUIPMENT FOR
LIQUIDS AND FLUIDS

p.482  HEATERS, LIGHTING
AND LENSES

p.495  CONSTRUCTION
AND PACKAGING

p.498  SAFETY AND
PROTECTION

p.512  FLAP
DISCS

p.533  CUTTING
WHEELS

p.541  TUNGSTEN CARBIDE
ROTARY BURRS

p.547  ABRASIVE
WHEELS

p.554  WIRE
BRUSHES

p.558  CLEANING AND
POLISHING

p.567  ABRASIVE
BELTS

INDEX

p.576  ALPHABETICAL
INDEX

p.592  NUMERICAL
INDEX

FERVI ANSWERS

+39 059.767172

1

CUSTOMERS SERVICE

- Product prices and availability
- Orders management
- marketing information
- Dealers and representatives
- Quotes / offers
- General information

2

TECHNICAL DEPARTMENT

- Technical information
- After sales support
- Spare parts
- Warranty
- Repair estimate

5

ENGLISH

www.fervi.com

 info@fervi.com



CONTACT US ON FACEBOOK

facebook.com/FerviProSmartEquipment

Our sales department will timely answer to all of your questions!



SUBSCRIBE TO OUR YOUTUBE CHANNEL

www.youtube.com/c/Fervitools

Check out our machineries videos, learn how to use them and discover Fervi latest news!



FOLLOW US ON LINKEDIN

www.linkedin.com/company/ferviprosmartequipment

You can stay updated on our company news and on all our big projects.



READING GUIDE

 PACKING

 PIECES

 MATERIAL

 SURFACE FINISHING

 STANDARD

 SHARPENING ANGLE

 INCLINATION

 REINFORCED

 FLAP TYPE

 IP GRADE

 FEMALE SQUARE DRIVE

 MALE SQUARE DRIVE

 APPLICATIONS

 MILLING







 TURNING







 ISO CLASS







 GRADE

PRICES





VAT NOT INCLUDED









	LATHES, MILLS AND DRILLS
<i>pag.004</i>	 — Bench lathes
<i>pag.026</i>	 — Drilling milling machines
<i>pag.040</i>	 — Floor drilling machines
<i>pag.052</i>	 — Drill presses
<i>pag.056</i>	 — Magnetic drills







	METAL WORKING MACHINERY
<i>pag.059</i>	 — Saw benches
<i>pag.063</i>	 — Bench grinders
<i>pag.067</i>	 — Sharpeners
<i>pag.069</i>	 — Belt sanders
<i>pag.071</i>	 — Metal sheet machines

	WOOD WORKING MACHINERY
<i>pag.076</i>	 — Wood working lathes
<i>pag.079</i>	 — Combination machines
<i>pag.084</i>	 — Mitre saw
<i>pag.086</i>	 — Band saws
<i>pag.091</i>	 — Belt sanders
<i>pag.094</i>	 — Dust collectors



	MACHINERY FOR FINISHING
<i>pag.096</i>	 — Sandblast cabinets
<i>pag.107</i>	 — Cleaning tanks
<i>pag.109</i>	 — Vacuum cleaners wet and dry
<i>pag.112</i>	 — Marking

	PRESSES AND HYDRAULIC PUMPS
<i>pag.115</i>	 — Hydraulic presses
<i>pag.118</i>	 — Manual presses
<i>pag.119</i>	 — Hydraulic pump units



	CAR AND MOTORCYCLE WORKSHOP
<i>pag.120</i>	 — Hydraulic trolley jacks
<i>pag.122</i>	 — Hydraulic cranes and engine stands
<i>pag.123</i>	 — Oil collecting units
<i>pag.123</i>	 — Winches
<i>pag.125</i>	 — Battery chargers
<i>pag.126</i>	 — Motorcycle and quad lifts
<i>pag.128</i>	 — Trolleys

	LIFTING AND HANDLING
<i>pag.129</i>	 — Hydraulic jacks
<i>pag.130</i>	 — Trolleys
<i>pag.133</i>	 — Cable hoists
<i>pag.134</i>	 — Lifting accessories
<i>pag.136</i>	 — Winches and tensioners
<i>pag.137</i>	 — Pallet handling







 **MACHINE VICES**

- pag.142*  — Precision vices
- pag.143*  — Vices

 **TABLES AND DIVIDERS**

- pag.147*  — Dividers
- pag.151*  — Working tables and magnetic chucks
- pag.154*  — Clamping



 **CHUCKS AND LIVE CENTERS**

- pag.155*  — Live centers
- pag.156*  — Keyless and self-centering chucks
- pag.161*  — Tapping chucks
- pag.162*  — Arbor for milling cutters
- pag.166*  — Morse taper adapters and collet chucks
- pag.168*  — Tool cabinets
- pag.169*  — Boring head

 **TOOL POSTS AND TOOL HOLDERS**







- pag.170*  — Tool posts







 **MACHINERY ACCESSORIES**







- pag.172*  — Pumps and accessories
- pag.173*  — Machine tool safety guards
- pag.174*  — Lamps





 **TOOLS FOR TURNING AND MILLING**





- pag.175*  — External tool holders
- pag.178*  — Internal tool holders
- pag.186*  — Milling cutters



		INSERTS, LATHE TOOLS AND TOOL BITS
<i>pag.195</i>		— Insert for lathe
<i>pag.201</i>		— Milling inserts
<i>pag.204</i>		— Tapping inserts
<i>pag.205</i>		— Lathe tools
<i>pag.206</i>		— Tool bits







		DRILLS AND HOLE SAWS
<i>pag.208</i>		— Metal twist drills
<i>pag.218</i>		— Hole saws
<i>pag.222</i>		— Hole cutters
<i>pag.226</i>		— Masonry drills
<i>pag.228</i>		— Diamond tools
<i>pag.231</i>		— Wood drill bits





		MILLING TOOLS
<i>pag.233</i>		— Machine reamers
<i>pag.234</i>		— Counterborers
<i>pag.235</i>		— Disc shaper cutters
<i>pag.236</i>		— End mills
<i>pag.237</i>		— Stepped cutters & Countersinks
<i>pag.239</i>		— End mills for wood



		TAPS AND DIES
<i>pag.240</i>		— Tap and die sets
<i>pag.242</i>		— HSS taps
<i>pag.244</i>		— Dies



		THREAD REPAIR
<i>pag.245</i>		— Thread repair set
<i>pag.252</i>		— Thread repair tools
<i>pag.254</i>		— Taps for thread repair
<i>pag.257</i>		— Thread repair insert





		BANDSAW BLADES AND SAW BLADES
<i>pag.258</i>		— Bandsaw blades
<i>pag.258</i>		— Saw blades





 CALIPERS, HEIGHT GAUGE AND RULERS	
<i>pag.262</i>	 — Digital calipers
<i>pag.262</i>	 — Calipers with dial gauge
<i>pag.263</i>	 — Vernier calipers
<i>pag.265</i>	 — Height gauge
<i>pag.265</i>	 — Steel and digital rules







 DIAL INDICATORS	
<i>pag.268</i>	 — Dial indicators
<i>pag.270</i>	 — Dial thickness gauges
<i>pag.271</i>	 — Edge finders



 MICROMETERS	
<i>pag.272</i>	 — Outside micrometers
<i>pag.273</i>	 — Inside micrometers

 GAUGE BLOCKS, SCREW GAUGE AND HOLE PLAIN GAUGE	
<i>pag.274</i>	 — Gauge blocks
<i>pag.275</i>	 — Gauges





 MEASURING TOOLS	
<i>pag.277</i>	 — Magnetic base
<i>pag.281</i>	 — Inspection plates
<i>pag.282</i>	 — Squares
<i>pag.284</i>	 — Screw pitch gauge

 PRECISION TAPES, LEVELS AND GONIOMETERS	
<i>pag.287</i>	 — Precision tapes
<i>pag.288</i>	 — Levels
<i>pag.290</i>	 — Protractor











 ANALOGIC AND DIGITAL METERS	
<i>pag.291</i>	 — Endoscopes
<i>pag.292</i>	 — Testers
<i>pag.294</i>	 — Digital meters
<i>pag.298</i>	 — Refractometers
<i>pag.299</i>	 — Hardness testers

 SCALES	
<i>pag.301</i>	 — Scales
<i>pag.302</i>	 — Dinamometers





BE BLACK EDITION

- pag.307*  — Wrenches
- pag.308*  — Hex keys
- pag.309*  — Screwdrivers
- pag.311*  — Pliers





 **WRENCHES**

- pag.314*  — Ratchets wrenches
- pag.315*  — Double open end wrenches
- pag.315*  — Combination spanners
- pag.318*  — Ring spanners
- pag.322*  — Tubular sockets
- pag.323*  — Hex keys
- pag.326*  — Tork keys
- pag.327*  — Sockets
- pag.329*  — Filter wrenches
- pag.330*  — Torque wrenches







 **SOCKET WRENCHES AND SCREW EXTRACTORS**

- pag.334*  — Quick-release ratchets
- pag.336*  — Sockets
- pag.349*  — impact sockets
- pag.357*  — Screw extractors





 **SCREWDRIVERS AND HAND RIVETERS**

- pag.358*  — Sockets screwdrivers
- pag.360*  — Screwdrivers
- pag.364*  — Precision screwdrivers
- pag.366*  — Hex bits
- pag.371*  — Hand riveters

 **PLIERS, HAMMERS, FILES AND CHISELS**

- pag.373*  — Pliers
- pag.377*  — Grip pliers
- pag.378*  — Pipe wrenches
- pag.379*  — Hammers
- pag.382*  — Chisels
- pag.385*  — Files
- pag.387*  — Levers





 **UTILITY KNIVES, DEBURRING AND CUTTING TOOLS**

- pag.388*  — Utility knives
- pag.390*  — Snaggers
- pag.392*  — Jigsaws arches
- pag.394*  — Scissors
- pag.395*  — Tube and bolt cutters





 **SETS AND FASTENINGS**

- PAG.398*  — Staplers and brad nailers
- PAG.399*  — Sets



 **WORKSHOP FURNITURE**

- pag.404*  — Workshop furniture
- pag.415*  — Workbenches
- pag.417*  — Cabinets
- pag.420*  — Cases

 **TOOL CABINETS AND TOOL SETS**

- pag.421*  — Tool rolling cabinets
- pag.430*  — Series of thermoformed tools
- pag.437*  — Tool boxes with tools
- pag.441*  — Tool boxes



 **BENCH VICES, CLAMPS AND ANVILS**

- pag.448*  — Bench vices
- pag.451*  — Vices
- pag.452*  — Anvils

 **PNEUMATIC**

- pag.453*  — Staplers and brad nailers
- pag.455*  — Air impact wrenches
- pag.459*  — Air die grinders
- pag.461*  — Air belt sander
- pag.463*  — Air guns
- pag.465*  — Spray guns
- pag.468*  — Air hose reel







 **SOLDERINGS, HOT AIR GUNS AND GLUE GUNS**

- pag.470*  — Solderings
- pag.471*  — Hot air guns
- pag.473*  — Glue guns

 **EQUIPMENT FOR LIQUIDS AND FLUIDS**

- pag.474*  — Oilers
- pag.475*  — Greaser guns
- pag.476*  — Spray
- pag.479*  — Tanks
- pag.479*  — Pumps
- pag.480*  — Pressure sprayers



 **HEATERS, LIGHTING AND LENSES**

- pag.482*  — Heaters
- pag.483*  — LED Lights
- pag.485*  — Lamps
- pag.486*  — Magnifier lens
- pag.487*  — Battery operated torches and lamps
- pag.492*  — Powers sockets
- pag.494*  — Generators

 **SAFETY AND PROTECTION**





- pag.498*  — Gloves
- pag.502*  — Eyewear
- pag.502*  — First aid
- pag.505*  — Noise-protection headphones
- pag.506*  — Masks
- pag.507*  — Shoes and boots

 **CONSTRUCTION AND PACKAGING**

- pag.495*  — Guns for chemicals
- pag.496*  — Trowels and putty knives
- pag.497*  — Packaging material



FLAP DISCS

- pag.514*  — Smartflex
- pag.518*  — Grindflex
- pag.522*  — Performance
- pag.526*  — Professional
- pag.530*  — Specialties





CUTTING WHEELS

- pag.533*  — Cutting & abrasive wheels
- pag.536*  — Grinding wheels
- pag.539*  — Diamond blades



TUNGSTEN CARBIDE ROTARY BURRS

- pag.541*  — Diamond cut burrs
- pag.541*  — Single cut burrs
- pag.541*  — Burrs for aluminium



ABRASIVE WHEELS

- pag.547*  — Fast-lock
- pag.549*  — Wheels with shaft
- pag.550*  — Wheels with hole
- pag.551*  — Wheels for satin finishers



WIRE BRUSHES

- pag.554*  — Brushes with bore
- pag.556*  — Brushes with shaft







CLEANING AND POLISHING

- pag.558*  — Abrasive Nylon
- pag.559*  — Non woven
- pag.560*  — Surface Conditioning
- pag.562*  — Felt
- pag.564*  — Cotton and Sisal



ABRASIVE BELTS

- pag.567*  — Vulcanized discs
- pag.568*  — Velcro discs
- pag.571*  — Rolls and sheets
- pag.575*  — Belts

VISION, MISSION & VALUES

FERVI holds its stance as leader in the MRO (**Maintenance, Repair and Operations**) sector, meeting all the professional and DIY demands for the construction, maintenance and repair of any item.

We are a solid, **reliable and competitive** company acting as a point of reference on the European front for research, design, production and distribution tool machinery and equipment compliant with the most stringent requirements on quality and reliability, at the heart of a market that grows alongside us.

VISION

To provide industry workers and those in the DIY sector with the most suitable, functional, safe products which can significantly improve the productivity and quality of their daily work.

MISSION

To design and produce, search and select, and distribute tool Machinery and Equipment with the best quality-price ratio, guaranteeing safety and service quality standards greatly superior to those of our closest competitors.

Our passion for the continuous renewal of products and services, the considerable respect for the work of our clients and sound awareness of the needs of our industry make us the ideal partner for any kind of large project or for small, everyday maintenance and repair jobs.

VALUES

EVERYTHING REVOLVES AROUND THE CLIENT

TRANSPARENCY

TEAM SPIRIT

CONTINUOUS IMPROVEMENT





A CONSTANTLY EVOLVING GROUP

An increasingly more reliably, complete choice for you.

Since 2019, the German company **Vogel Germany** GmbH & CO KG has been a part of the Fervi group, an important player in the production and sale of top quality Made in Germany measuring instruments.

Vogel Germany GmbH & CO KG joined the controlled Ri-Flex Abrasives S.r.l., leading company in the production of top quality abrasive flap discs and Sitges Maquinas Y Accesorios, long-standing distributor of the Fervi brand on the Iberian peninsula.



THE EVOLUTION OF THE CATALOGUE



CAT '12
3.800
 REFERENCES



CAT 36
4.700
 REFERENCES

1978

Veprug Srl was founded and expanded as a wholesaler in the area of Modena.

1991

Veprug expanded within the Fervi brand business plan.

2011

The company changed hands and consolidated its growth.

2012

The first Fervi catalogue distributed in 35,000 copies.

2013

Zero impact achieved. The new Fervi offices are self-sufficient from an energy point of view.



CAT 38
5.700
 REFERENCES



CAT 40
6.800
 REFERENCES



CAT 42
8.500⁺
 REFERENCES

2015

Expansion of the made in Italy, Ri-Flex Abrasives joined the Fervi group.

2018

Fervi celebrated its first 40 years in business with a flotation on the stock market and the purchase of a 40% share of Sitges Maquinas y Acesorios.

2019

The Fervi Group acquired 100% control of Vogel Germany & Co Kg.

2020

Find out where Fervi will take you thanks to the expansion of the range and all the latest products.

Riflex, specific experience **MADE IN ITALY**



Since 1982, Riflex has stood out on the international stage thanks to its specific MADE IN ITALY experience in the production of flap discs made of corundum, zirconium and ceramic zirconium with supports made from both nylon and fibreglass, and in the manufacture of automatic systems for their production, testing and packaging.

Know-how and quality

Riflex oversees the entire production chain thanks to relationships spanning decades with key suppliers of raw materials (abrasive backing plates, supports and glue). More than thirty years of experience has allowed the company to develop its own recipes and quality protocols which are among the highest levels worldwide.



A CAPILLARY PRESENCE. INTERNATIONAL TRUST.



Our distribution and assistance. We will always be at your side.

With over 4500 sales outlets in Italy and continuous growth abroad, Fervi has established a well-rooted position: increasingly closer to the client's needs.

The group has undertaken to focus on constant commercial expansion, supported by an excellent technical assistance team which ensures a complete range of products and services across the board, throughout Europe.

Our highly qualified technicians provide technical support and an efficient internal repair service as well as a consulting service for the installation and maintenance of equipment.

MANAGEMENT, ORGANISATION AND METHOD. QUALITY ACCORDING TO FERVI.

THE FERVI METHOD

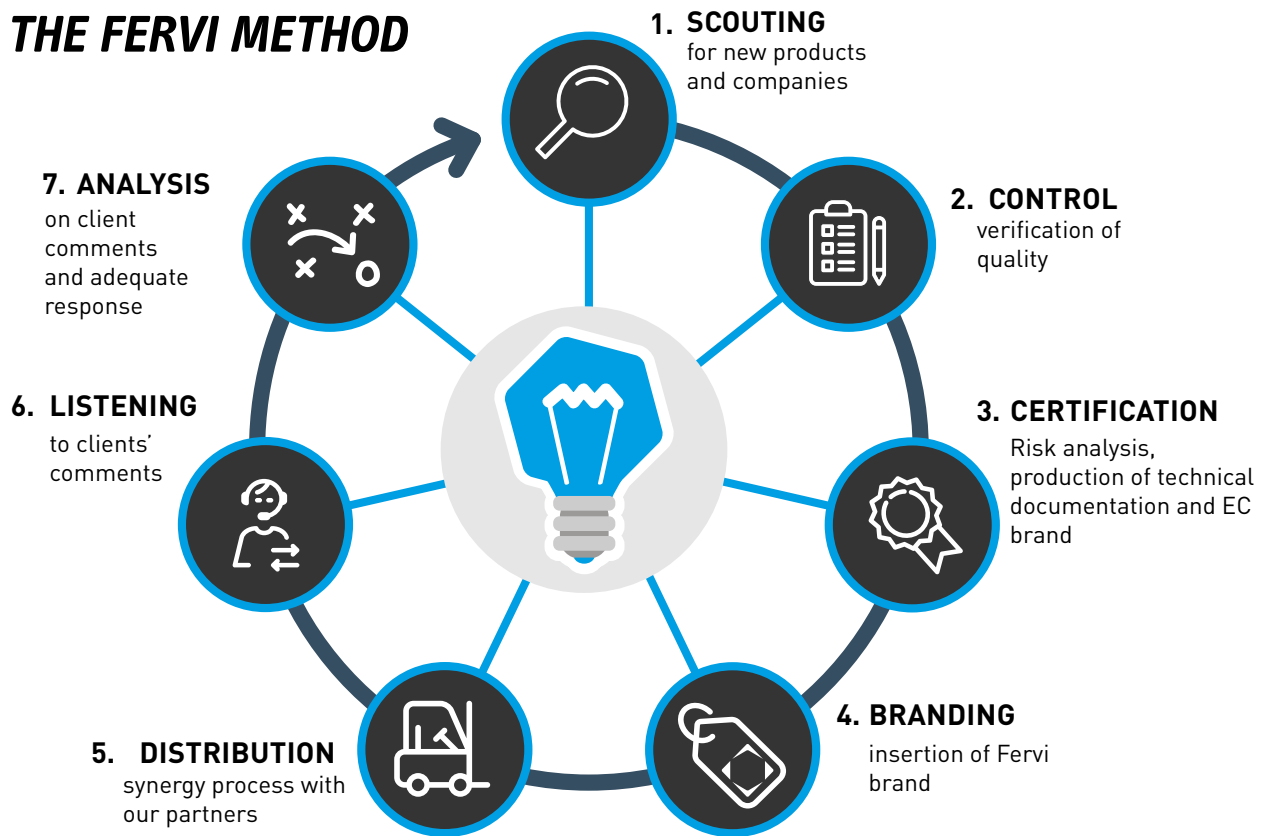

OUR FIGURES.

Spaces, people and horizons in the world of Fervi.

1+1
SHOW ROOM
PHYSICAL AND VIRTUAL

1.000⁺
SPARE PARTS REFERENCES

3.000⁺
ORDERS PER MONTH

8.500⁺
CATALOGUE REFERENCES

10.000^{MQ}
OF STORAGE SPACE

200^{MILIONI}
PIECES ON THE MARKET

OUR CERTIFICATIONS. *A quality that stems from responsibility.*

A sense of Fervi's social and business responsibility is at the root of each initiative and activities undertaken by those in the Fervi Group and those involved.

Our colleagues

Our primary strength, protected by processes and devices and certificates compliant with the highest standards. A positive, safe environment in which to work towards a strong, consolidated company well-being.



Our clients

Each Fervi brand product is the result of our daily commitment. 100% top quality, reliability and safety at all times.

Our partners

Those collaborating with the Fervi Group can always depend on a certified financial reliability. An additional sign of trust to build solid, productive relations.

The environment is for everyone

We have achieved energy self-sufficiency, thanks to the installation of state-of-the-art photovoltaic systems.

+ ITEMS, - PAGES

Our attention to environmental sustainability has led us to create a catalog with over 10% fewer pages despite 20% more references than catalog 40! A lot of effort, but it's always worth it for our planet!





FERVI FOR SPORT



WELCOME TO THE TEAM
*We shall do important things.
 Together.*

With each appointment we support sporting organisations which reflect our own values of a sense of belonging and respect for our competitors, loyalty and a high level of competition.

Aruba.it Racing Ducati - Superbike Team
 Vanoli Basket - Series A Basketball League
 Hockey Cortina - Cortina Ice Sports



FERVI FOR UNIVERSITIES



OUR DIGITAL ATTITUDE.

Quality for sharing.



Access the Fervi Virtual Show room and take a look around our shelves to discover the range of equipment ideal for your work.



Scan the QR Code with your smart phone or visit fervi.com and access Fervi's Virtual Show Room.



CONTACT US ON FACEBOOK

facebook.com/FerviProSmartEquipment

our sales office will answer your questions as quickly as possible.



FOLLOW OUR YOUTUBE CHANNEL

www.youtube.com/c/Fervitools

you can see our tool machinery in use and discover the latest Fervi brand products.



FOLLOW US ON LINKEDIN

www.linkedin.com/company/ferviprosmartequipment

you can keep up-to-date with the latest from the company and all our important projects.



CREATE YOUR SHOWROOM

AN EXCLUSIVE PROPOSAL FOR AUTHORISED RETAILERS
 more than **2,500 m²** of gazebo installed, more than **700 linear metres** of walls

Become an authorised retailer:

Fervi will provide you with the furnishings, you will increase turnover and productivity per square metre, as 750 other clients have already done!

Confirmation is given of the success of the "Fervi furnishes your space" initiative, aimed exclusively at authorised retailers of our brand to enhance the image of each sales outlet and encourage sell in sell out traffic: indeed, only Fervi dealers can ask for our furnishing solutions at no additional cost, ideal for fitting out your exhibiting area at fairs and events.

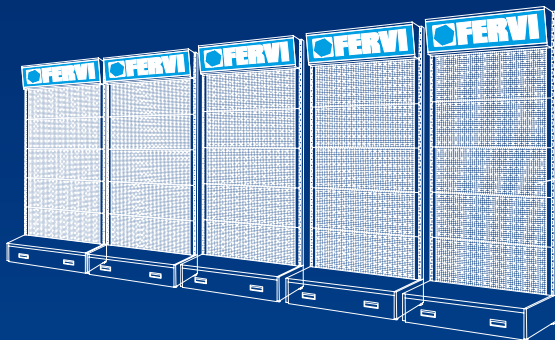

MODULAR PANEL STANDS



The client can choose from a selection of 46 modular panels to create the display that best suits their needs.

The structure can hold from 2 to 4 panels keeping the space on the tray to display other products.



GAZEBO

Available with or without wall to enhance the exhibiting area.

Ask your local sales rep. or contact us for information at info@fervi.com

Art.	Desc.	Page	Art.	Desc.	Page
 T080F	GEAR HEAD LATHE WITH READ OUT	6	 S383	BENCH GRINDER WITH BELT	65
 T075I	GEAR HEAD LATHE WITH INVERTER	7	 A003/32	TWIST DRILLS GRINDING MACHINE	67
 T070/400V13A	GEAR HEAD LATHE WITH INVERTER	9	 A003/13A	TWIST DRILL GRINDING MACHINE	68
 T069/400V13A	INVERTER GEAR HEAD LATHE	11	 A003/32CBN	CBN WHEEL	69
 T998/400V13A	INVERTER GEAR HEAD LATHE WITH READ OUT	13	 A003/32SDC	SDC WHEEL	69
 0506	BENCH LATHE	24	 A003/13ACBN	CBN WHEEL	69
 F060I	INVERTER VERTICAL MILLING MACHINE	28	 A003/13ASDC	SDC WHEEL	69
 F060V	VERTICAL MILLING MACHINE	29	 0667/100	TILTING BELT SANDER	69
 F060	VERTICAL MILLING MACHINE	30	 0667/150	TILTING BELT SANDER	70
 T073	FLOOR DRILLING MILLING MACHINE	32	 0483	MINI HAND BRAKE	71
 T073DA	FLOOR DRILLING MILLING MACHINE	33	 C076/30	MOTORIZED 3 ROLL PIPE & PROFILE BENDING MACHINES	73
 T061A	GEARED DRILLING MILLING MACHINE	35	 C022/100	ROLL FORMING MACHINE	73
 TR01/180	RADIAL DRILLING MACHINE	43	 0648	WOOD LATHE	77
 T145	DRILLING MACHINE	44	 0517A	THICKNESSER	80
 T041DA	GEARED DRILLING MACHINE	45	 0656/254	PANEL SAW	83
 T041	GEARED DRILLING MACHINE	46	 0656/310	PANEL SAW	84
 T072DA	FLOOR DRILLING MACHINE WITH DRIVE BELT	47	 0507	DUST COLLECTOR	94
 T072	FLOOR DRILLING MACHINE WITH BELT DRIVE	48	 0507/14	PLASTIC BAG SET	95
 0752CM3	FLOOR DRILL PRESS WITH DRIVE BELT	50	 0507/15	FILTER BAG	95
 0750CM3	DRILL PRESS WITH DRIVE BELT	53	 0507/07	PLASTIC HOSE FITTING	95
 0011	DRILL PRESS WITH DRIVE BELT	55	 0507/4R	FITTING WITH 4 DIAMETERS	95
 0518/38M	MAGNETIC TAPPING/DRILL	57	 S035P	PRESSURE SANDBLAST CABINET	97
 0518/55H	HORIZONTAL MAGNETIC DRILL	57	 S035D	VACUUM SANDBLAST CABINET	98
 0518/80	MAGNETIC DRILL	57	 0615	PRESSURE SANDBLAST CABINET	99
 0132	CUTTING BAND SAW	60	 SA01-CTRx	ROTARY TABLE FOR SANDBLAST CABINET	100

Art.	Desc.	Page	Art.	Desc.	Page
 SA01/TR	ROTARY TABLE	104	 0485	SHOP PRESS PIN SET	118
 SA01/C	CYCLONE FOR SAND BLAST CABINET	104	 0567	LOW PROFILE HYDRAULIC TROLLEY JACK	120
 SA01/F	CYCLONE FILTER	105	 0375A	LOW PROFILE HYDRAULIC TROLLEY JACK	120
 0632-	DETERGENT LIQUID	108	 S029	ELECTRO-HYDRAULIC MOTORCYCLE LIFT	126
 A024/10	WET AND DRY VACUUM CLEANER	109	 S029P	ELECTRO-HYDRAULIC MOTORCYCLE LIFT	126
 A024/602	60L 2 MOTORS WET AND DRY VACUUM CLEANER	110	 S027	ELECTRO-HYDRAULIC MOTORCYCLE LIFT	126
 ACAS/001	3PC INLET SPONGE FILTER SET FOR VACUUM CLEANER	111	 S027ATV	ELECTRO-HYDRAULIC ATV & MOTORCYCLE LIFT	126
 ACAS/002	HEPA FILTER FOR VACUUM CLEANER	111	 C065/2	PP TWO SHELVES TOOL CART	131
 ACAS/003	FLEXIBLE HOSE FOR VACUUM CLEANER	111	 C075/2	PP TWO SHELVES TOOL CART	131
 ACAS/004	METAL EXTENSION PIPE FOR VACUUM CLEANER	111	 0028R	LOWERED MANUAL PALLET TRUCK	138
 ACAS/005	PAIR OF PLASTIC TUBES FOR VACUUM CLEANER	111	 0143A	MANUAL STACKER	139
 ACAS/006	3PC INLET SPONGE FILTER SET FOR VACUUM CLEANER	111	 0143/25	MANUAL STACKER	139
 ACAS/007	FILTER FOR VACUUM CLEANER	111	 M027-	DRILL PRESS VICE	145
 ACAS/008	10PC PAPER BAG SET FOR VACUUM CLEANER	111	 0188-xG	2 - WAY CROSS VICE WITH SWIVEL BASE	146
 ACAS/009	FLEXIBLE HOSE FOR VACUUM CLEANER	111	 T016/100	TILTING ROTARY TABLE	147
 ACAS/010	BIG BRUSH FOR VACUUM CLEANER	111	 T017/100	TILTING ROTARY TABLE WITH CHUCK	147
 ACAS/011	MULTI FUNCTION BRUSH FOR VACUUM CLEANER	111	 T018/350	ALUMINIUM CROSS WORKING TABLE	152
 ACAS/012	10PC PAPER BAG SET FOR VACUUM CLEANER	111	 T018/330	ALUMINIUM CROSS WORKING TABLE	153
 ACAS/013	10PC BAG SET	111	 ST45-xL	EXTENDED MORSE TAPER ADAPTERS	156
 ACAS/014	3PC PLASTIC TUBE SET	111	 P444-	4 JAW INDEPENDENT CHUCK	159
 ACAS/015	SMALL BRUSH	111	 M038	CROSS FEED MOTOR	172
 ACAS/016	HEPA FILTER	111	 0531A	LED LIGHT MACHINE OPERATION LAMP	174
 ACAS/017	3PC INLET SPONGE FILTER SET	111	 0532A	LED LIGHT MACHINE OPERATION LAMP	174
 P039	ENGINEER' S SCRIBER WITH METAL BODY AND HARD-METAL POINT	114	 0532A/230V	LED LIGHT MACHINE OPERATION LAMP	174
 P039/PR	2 PCS SET HARD-METAL POINT	114	 0537A	LED LICHT MASCHINEN BETRIEBSLAMPE	174

Art.	Desc.	Page	Art.	Desc.	Page
 0538A	LED LIGHT MACHINE OPERATION LAMP	174	 ADLTxA1	MILLING INSERTS	201
 F407-	MILLING CUTTER WITH NEGATIVE INSERTS FOR FACE MILLING	188	 OFEXxA	MILLING INSERTS	201
 CCMTxA	TURNING INSERTS	195	 ONMXxA	MILLING INSERTS	202
 CNMGxF15	TURNING INSERTS	195	 SEHTxA	MILLING INSERTS	202
 CNMGxF25	TURNING INSERTS	195	 SEHXxA	MILLING INSERTS	203
 CNMGxM25	TURNING INSERTS	195	 SNMXx	MILLING INSERTS	203
 CNMGxM35	TURNING INSERTS	196	 GCMxA	CUTTING INSERTS	204
 DCMTxA	TURNING INSERTS	196	 P023-	STRAIGHT SHANK TWIST DRILL	212
 DNMGxM25	TURNING INSERTS	196	 P023-xL	LONG TYPE STRAIGHT SHANK TWIST DRILL	213
 DNMGxM35	TURNING INSERTS	196	 P023-xL1	EXTRA LONG TYPE STRAIGHT SHANK TWIST DRILL	213
 SCMTxA1	TURNING INSERTS	197	 P023-xL2	EXTRA LONG TYPE STRAIGHT SHANK TWIST DRILL	213
 SCMTxA2	TURNING INSERTS	197	 P023-xL3	EXTRA LONG TYPE STRAIGHT SHANK TWIST DRILL	214
 SCMTxA3	TURNING INSERTS	197	 P056/10S	CENTER DRILL SET	218
 SNMGxF15	TURNING INSERTS	198	 P037-	MILLING DRILLS	218
 SNMGxF25	TURNING INSERTS	198	 P036-	SPOT DRILLS	218
 SNMGxM25	TURNING INSERTS	198	 F011-xP	TWIST DRILLS WELDON SHANK	218
 SNMGxM35	TURNING INSERTS	198	 F002-xP	TWIST DRILLS WELDON SHANK	219
 TCMTxA	TURNING INSERTS	199	 F002-xPL	LONG TWIST DRILLS WELDON SHANK	220
 WNMGxM25	TURNING INSERTS	199	 P076-	CARBIDE TIPPED HOLE CUTTERS FOR MASONRY	227
 WNMGxM35	TURNING INSERTS	199	 P076-Gx	ARBOR FOR HOLE CUTTERS FOR MANSORNY	227
 TNMGxF15	TURNING INSERTS	199	 P076-Gx400	LONG ARBOR FOR HOLE CUTTERS FOR MANSORNY	227
 TNMGxF25	TURNING INSERTS	200	 P076-Px	CARBIDE TIPPED PILOT DRILL FOR HOLE CUTTERS FOR MASONRY	227
 TNMGxM25	TURNING INSERTS	200	 P076/006S	CARBIDE TIPPED HOLE CUTTER SET FOR MASONRY	228
 TNMGxM35	TURNING INSERTS	200	 P076/008S	CARBIDE TIPPED HOLE CUTTER SET FOR MASONRY	228
 VBMTxA	TURNING INSERTS	200	 P031-	DIAMOND DRILL BITS AND CORE DRILLS WITH CONTINUOUS EDGE	228

Art.	Desc.	Page
P031-xL	DIAMOND DRILL BITS AND CORE DRILLS WITH CONTINUOUS EDGE	228
P031/06P	PILOT TIP	228
P031/03S	DIAMOND DRILL BIT AND CORE DRILL WITH CONTINUOUS EDGE SET	228
P031/05S	DIAMOND DRILL BIT AND CORE DRILL WITH CONTINUOUS EDGE SET	229
P031/06S	DIAMOND DRILL BIT AND CORE DRILL WITH CONTINUOUS EDGE SET	229
P033-	DIAMOND DRILL BITS WITH CONTINUOUS EDGE	229
P033/03S	DIAMOND DRILL BIT AND CORE DRILL WITH CONTINUOUS EDGE SET	229
P034-	M14 DIAMOND DRILL BITS AND CORE DRILLS WITH CONTINUOUS EDGE	229
P034/05S	M14 DIAMOND DRILL BIT AND CORE DRILL WITH CONTINUOUS EDGE SET	230
P034/06S	M14 DIAMOND DRILL BIT AND CORE DRILL WITH CONTINUOUS EDGE SET	230
P035-	DIAMOND DRILL BITS WITH CONTINUOUS EDGE	230
P035/04S	DIAMOND DRILL BIT SET WITH CONTINUOUS EDGE	230
D009/5-12	DRILL SUCTION CUP WITH GUIDING HOLES	230
D009/5-85	DRILL SUCTION CUP WITH ADJUSTABLE HOLE FRAME	230
P052-	BRAD POINT WOODWORKING DRILLS	231
P052/08S	BRAD POINT WOODWORKING DRILLS SET	231
L018-	SOLID CAP SCREW COUNTER BORE BEFORE THREAD GRADE	233
L018S	SOLID CAP SCREW COUNTER BORE SET BEFORE THREAD	234
L019S	SOLID CAP SCREW COUNTER BORE SET FINE GRADE	234
L019-	SOLID CAP SCREW COUNTER BORE FINE GRADE	234
L020S	SOLID CAP SCREW COUNTER BORE SET MEDIUM GRADE	234
M015S	SPIRAL POINT TAP AND DRILL SET	240
E010B	METRIC THREAD REPAIR F-COIL SET	245
E010E	METRIC THREAD REPAIR F-COIL SET	245
E011A	METRIC THREAD REPAIR F-COIL SET	246

Art.	Desc.	Page
E011B	METRIC THREAD REPAIR F-COIL SET	246
E011C	METRIC THREAD REPAIR F-COIL SET	246
E011D	METRIC THREAD REPAIR F-COIL SET	246
E011-Mx1	METRIC THREAD REPAIR F-COIL SET	247
E011-Mx2	METRIC THREAD REPAIR F-COIL SET	247
E011-MxC	SPARK PLUG METRIC THREAD REPAIR F-COIL SET	248
E010-MxExC	STAINLESS STEEL THREAD REPAIR INSERT	248
E011/M140X125B	METRIC SPARK PLUG SOLID THREAD REPAIR SET	248
E011-M140X125Ex	SOLID THREAD INSERT SPARK PLUG SET	248
E011/M140X125MCB	METRIC COMBINED TAP FOR SOLID INSERT	248
E011/MC	METRIC GLOW PLUG SOLID THREAD REPAIR SET	249
E011/BSW	1/4-1/2 BSW THREAD REPAIR F-COIL SET	249
E011-BSWx	BSW THREAD REPAIR F-COIL SET	249
E011/BSF	1/4-1/2 BSF THREAD REPAIR F-COIL SET	249
E011-BSFx	BSF THREAD REPAIR F-COIL SET	250
E011-BSPx	BSP THREAD REPAIR F-COIL SET	250
E011/UNC	1/4-1/2 UNC THREAD REPAIR F-COIL SET	250
E011-UNCx	UNC THREAD REPAIR F-COIL SET	250
E011/UNF	1/4-1/2 UNF THREAD REPAIR F-COIL SET	251
E011-UNFx	UNF THREAD REPAIR F-COIL SET	251
E010-MxE1	STAINLESS STEEL THREAD REPAIR INSERT H=1XD	251
E010-MxE15	STAINLESS STEEL THREAD REPAIR INSERT H=1.5XD	252
E010-MxE2	STAINLESS STEEL THREAD REPAIR INSERT H=2XD	252
E010-MxE25	STAINLESS STEEL THREAD REPAIR INSERT H=2.5XD	252
E010-MxE3	STAINLESS STEEL THREAD REPAIR INSERT H=3XD	253

Art.	Desc.	Page	Art.	Desc.	Page
E010-MxExA	SELF-LOCK STAINLESS STEEL THREAD REPAIR INSERT H=1.5XD	253	RLAx-RS-MID	STAINLESS STEEL RULE MID	267
E010-BSWxEx	STAINLESS STEEL THREAD REPAIR INSERT BSW H=1.5XD	253	RLAx-RD-MID	STAINLESS STEEL RULE MID	267
E010-BSFxEx	STAINLESS STEEL THREAD REPAIR INSERT BSF H=1.5XD	253	REGx-FS	STAINLESS STEEL RULE WITH HOOK 90°	267
E010-BSPxEx	STAINLESS STEEL THREAD REPAIR INSERT BSP H=1.5XD	254	0129-	CARPENTER TRY SQUARE	282
E010-UNCxEx	STAINLESS STEEL THREAD REPAIR INSERT UNC H=1.5XD	254	0132-	BEVEL SQUARE	282
E010-UNFxEx	STAINLESS STEEL THREAD REPAIR INSERT UNF H=1.5XD	254	0139-	MITRE SQUARE	282
E011-MxM	METRIC F-COIL STI TAP	255	FGx	FEELER GAUGE SET	284
E011-MxM2	METRIC F-COIL 2 PCS STI TAPS	255	FGx-AI	FEELER GAUGE SET, STAINLESS STEEL	284
E011-MxMC	METRIC F-COIL STI COMBINED TAP	255	TGx-AE	THICKNESS GAUGE FOIL	284
E011-BSWxM	BSW F-COIL STI TAP	256	HT125	HOLDER FOR FEELER GAUGE BLADES	285
E011-BSFxM	BSF F-COIL STI TAP	256	0204	MIRROR POLISH LONG PATTERN COMBINATION SPANNER SET	316
E011-BSPxM	BSP F-COIL STI 2PCS TAPS	256	0199P-	MIRROR POLISH LONG PATTERN COMBINATION SPANNER	317
E011-UNCxM	UNC F-COIL STI TAP	256	0895-	PERCUSSION OPEN WRENCHES	319
E011-UNFxM	UNF F-COIL STI TAP	257	0896-	POLYGONAL PERCUSSION WRENCHES	319
E011-Ux	F-COIL MOUNTING TOOL	257	0196-	STUBBY MIRROR POLISH COMBINATION SPANNERS	320
E011-UMx	F-COIL MOUNTING TOOL HEXAGONAL DRIVE	257	0134-	FLAT POLYGONAL WRENCH	320
E011-Ax	F-COIL TANG BREAKING TOOL	257	0614	SET OF HALF MOON RING SPANNERS	321
E011-Ex	F-COIL PULLER	257	0340S	DOUBLE HEAD SOCKET WRENCH SET	321
LBx	BI-METAL BLADE FOR METAL	258	0558/EM	HEX KEY SET WITH DIAMOND TIP	323
REAx-FS	STAINLESS STEEL RULE	265	0558/EP	HEX KEY SET WITH DIAMOND TIP	323
REAx-FD	STAINLESS STEEL RULE	265	0558/GE	HEX KEY SET	323
REAx-RS	STAINLESS STEEL RULE	266	0545/EF	COLORLED HEX KEY SERIES	323
REAx-RD	STAINLESS STEEL RULE	266	C856-	TWO WAY HEX KEY WITH PLASTIC HANDLE	324
REAx-RS-MID	STAINLESS STEEL RULE MID	266	0545/TF	COLORLED TORX KEY SERIES	326
REAx-RD-MID	STAINLESS STEEL RULE MID	266	0558/TX	TORX KEY SET WITH DIAMOND TIP	326

Art.	Desc.	Page	Art.	Desc.	Page
	C855- TWO WAY TORX KEY WITH PLASTIC HANDLE	327		0611 STAINLESS STEEL SNAP-OFF UTILIY KNIFE	389
	0359- T-HANDLE SPARK PLUG SOCKET WRENCH	327		0376/AC 150 PCS CARBON STEEL NUT RIVET SET	398
	0815- TORQUE WRENCH	332		0376/AL 120 PCS ALUMINUM NUT RIVET SET	399
	0341- IMPACT HEX SOCKET WITH PLASTIC SLEEVE	353		0376/AI 150 PCS STAINLESS STEEL NUT RIVET SET	399
	0341/5S IMPACT HEX SOCKET SET WITH PLASTIC SLEEVE	354		0398 SCREW AND U TYPE CUSHIONS ASSORTMENT	401
	0341-xL LONG IMPACT HEX SOCKET WITH PLASTIC SLEEVE	354		0465 RUBBER GROMMET ASSORTMENT	401
	0341/3LS IMPACT HEX SOCKET SET WITH PLASTIC SLEEVE	354		0468 CONNECTING PLATE AND SCREW ASSORTMENT	401
	0341-Sx PLASTIC SLEEVE FOR HEX IMPACT SOCKETS	354		A008A WORKSHOP MODULAR FURNITURES	405
	D883- ELECTRICIAN FLAT SCREWDRIVER WITH DIAMOND TIP	360		A008B WORKSHOP MODULAR FURNITURES	405
	D884- FLAT SCREWDRIVER WITH DIAMOND TIP	360		A008C WORKSHOP MODULAR FURNITURES	405
	D884/6038 FLAT SCREWDRIVER WITH DIAMOND TIP	360		A008D WORKSHOP MODULAR FURNITURES	405
	D882- CROSS SCREWDRIVER PH WITH DIAMOND TIP	360		A008E WORKSHOP MODULAR FURNITURES	406
	D882/2038 CROSS SCREWDRIVER PH WITH DIAMOND TIP	360		A008F WORKSHOP MODULAR FURNITURES	406
	D885- CROSS SCREWDRIVER PZ WITH DIAMOND TIP	360		A008G WORKSHOP MODULAR FURNITURES	406
	D885/2038 CROSS SCREWDRIVER PZ WITH DIAMOND TIP	361		A008H WORKSHOP MODULAR FURNITURES	406
	D880/006 DIAMOND TIP SCREWDRIVER SET	361		A008I WORKSHOP MODULAR FURNITURES	407
	P883- SLOT PRECISION SCREWDRIVER	364		A008L WORKSHOP MODULAR FURNITURES	407
	P882- PHILLIPS PRECISION SCREWDRIVER	364		A008M WORKSHOP MODULAR FURNITURES	407
	P881- TORX PRECISION SCREWDRIVER	364		A008N WORKSHOP MODULAR FURNITURES	407
	P886- HEXAGONAL PRECISION SCREWDRIVER	364		A007P WORKSHOP MODULAR FURNITURES	408
	P880/06S PRECISION SCREWDRIVER SERIES	364		A008P WORKSHOP MODULAR FURNITURES	408
	P881/06S TORX PRECISION SCREWDRIVER SERIES	364		A007Q WORKSHOP MODULAR FURNITURES	408
	0358 SCREWDRIVER BIT AND SOCKET SET	367		A008Q WORKSHOP MODULAR FURNITURES	408
	0613 STAINLESS STEEL SNAP-OFF UTILIY KNIFE	388		A007R WORKSHOP MODULAR FURNITURES	408
	0612 STAINLESS STEEL SNAP-OFF UTILIY KNIFE	388		A008R WORKSHOP MODULAR FURNITURES	408

Art.	Desc.	Page	Art.	Desc.	Page
	A007S WORKSHOP MODULAR FURNITURES	408		A007/07 PANELS CONNECTOR	411
	A008S WORKSHOP MODULAR FURNITURES	408		A007/11 HALF PANEL CONNECTOR	412
	A007T WORKSHOP MODULAR FURNITURES	409		A007xP WORK PLATES	412
	A008T WORKSHOP MODULAR FURNITURES	409		B009/A2 WORKBENCH KIT	416
	A007U WORKSHOP MODULAR FURNITURES	409		B009/B2 WORKBENCH KIT	416
	A008U WORKSHOP MODULAR FURNITURES	409		C086/01C MODULAR DRAWER UNIT WITH PULL-OUT DRAWERS	419
	A007UF WORKSHOP MODULAR FURNITURES	409		C086/01T MODULAR DRAWER UNIT WITH PULL-OUT TRAYS	419
	A008UF WORKSHOP MODULAR FURNITURES	409		C086/02C MODULAR DRAWER UNIT WITH PULL-OUT DRAWERS	419
	A007V WORKSHOP MODULAR FURNITURES	409		C086/02T MODULAR DRAWER UNIT WITH PULL-OUT TRAYS	419
	A008V WORKSHOP MODULAR FURNITURES	409		C086/04C MODULAR DRAWER UNIT WITH PULL-OUT DRAWERS	419
	A007/02 TALL CABINET	410		C086/04T MODULAR DRAWER UNIT WITH PULL-OUT TRAYS	419
	A007/23 2 DOOR TALL CABINET	410		C086/12C MODULAR DRAWER UNIT WITH PULL-OUT DRAWERS	419
	A007/03 DOOR CABINET	410		C190 7 DRAWERS ROLLER CABINET	422
	A007/06 MULTIFUNCTION CABINET	410		C960/F6 TOOL ROLLING CABINET WITH 6 DRAWERS	422
	A007/18 HOSE REELS CABINET	410		C960/F7 TOOL ROLLING CABINET WITH 7 DRAWERS	422
	A007/04 TOOL CABINET WITH 4 DRAWERS	410		C960/F8 TOOL ROLLING CABINET WITH 8 DRAWERS	422
	A007/05 TOOL CABINET WITH 5 DRAWERS	410		C960/B6 TOOL ROLLING CABINET WITH 6 DRAWERS	423
	A007/17 TOOL CABINET WITH 7 DRAWERS	410		C960/B7 TOOL ROLLING CABINET WITH 7 DRAWERS	423
	A007/20 TOOL CABINET WITH 9 DRAWERS	411		C960/B8 TOOL ROLLING CABINET WITH 8 DRAWERS	423
	A007/22 TROLLEY	411		C960/AM01 TOOL ROLLING CABINET WITH AUTOMOTIVE TOOLS	429
	A007/16 ROLLING CABINET	411		TM01/044 FLAT SCREWDRIVER SET WITH DIAMOND TIP IN FOAM TRAY	432
	A007/21 LARGE AMERICAN TOOL CABINET	411		TM01/045 CROSSTIP SCREWDRIVER SET WITH DIAMOND TIP IN FOAM TRAY	432
	A007/211 LARGE AMERICAN TOOL CABINET	411		TM01/046 MIXED SCREWDRIVER SET WITH DIAMOND TIP IN FOAM TRAY	432
	A007/01 WALL CABINET	411		TM01/050 MEASURING INSTRUMENTS FOR AUTOMOTIV IN FOAM TRAY	435
	A007/10 HANGING PANEL	411		TM01/052 PNEUMATIC SERIES FOR AUTOMOTIVE IN FOAM TRAY	435

Art.	Desc.	Page	Art.	Desc.	Page
 TM01/053	ADDITIONAL TOOLS SERIES FOR AUTOMOTIVE IN FOAM TRAY	435	 G030-	EMULSIFYING OIL	476
 0105T	TOOL TROLLEY WITH ACCESSORIES	437	 S401/00	MULTI-FUNCTION SPRAY	476
 0110T	TOOL BOX WITH TROLLEY, TOOLS AND ACCESSORIES	437	 S401/07	BRAKE CLEANER, CARBURETORS AND THROTTLE BODIES	478
 0399	TOOL BOX WITH TOOLS AND ACCESSORIES	439	 S401/14	PURE ZINC	478
 0434	TOOL BOX WITH TOOLS AND ACCESSORIES	439	 S401/15	ZINC ADHESIVE LUBRICANT FOR CHAINS	478
 0557	MULTITOOL BACKPACK	445	 S401/16	LITHIUM GREASE	478
 0520-xG	ALUMINIUM MAGNETIC JAW PAIR WITH RUBBER FACE	449	 0218-xB	10W LED FLOODLIGHT WITH STAND	483
 0520-xA	ALUMINIUM MAGNETIC JAW PAIR	449	 0218-xS	10W LED FLOODLIGHT WITH MOTION AND BRIGHTNESS SENSOR	484
 0520-xP	PRISMATIC ALUMINIUM MAGNETIC JAW PAIR	450	 0218/50T	10W LED FLOODLIGHT WITH TRIPOD	484
 0520-xF	ALUMINIUM MAGNETIC JAW PAIR WITH FIBER FACE	450	 0482/3	HEAD LAMP WITH SENSOR	487
 0520-xS	SERIES OF ALUMINUM MAGNETIC JAW PAIRS	450	 DF2100-Z	SMARTFLEX FLAP DISC CLASSIC	514
 AP01	AIR IMPACT WRENCH	455	 DF2150-Z	SMARTFLEX FLAP DISC CLASSIC	514
 AP02	AIR IMPACT WRENCH	455	 DN2100-Z	SMARTFLEX FLAP DISC CLASSIC	515
 AP03	AIR IMPACT WRENCH	455	 DN2300-Z	SMARTFLEX FLAP DISC DUAL FLAP	515
 AP04	AIR IMPACT WRENCH	455	 DF2100-A	SMARTFLEX FLAP DISC CLASSIC	516
 AP05	AIR IMPACT WRENCH	456	 DF2150-A	SMARTFLEX FLAP DISC CLASSIC	516
 AP05/150	AIR IMPACT WRENCH	456	 DN2100-A	SMARTFLEX FLAP DISC CLASSIC	516
 AP06	AIR IMPACT WRENCH	456	 DN4100-Z	GRINDFLEX FLAP DISC CLASSIC	519
 0378/1510	AUTO REWIND AIR HOSE REEL	468	 DF6100-Z	PERFORMANCE FLAP DISC CLASSIC	522
 0033A	HIGH PRECISION TEMPERATURE -CONTROLLED SOLDERING IRON STATION	470	 DF6150-Z	PERFORMANCE FLAP DISC CLASSIC	522
 0031	HIGH PRECISION TEMPERATURE -CONTROLLED SOLDERING IRON STATION	470	 DN6300-Z	PERFORMANCE FLAP DISC DUAL FLAP	523
 0027/30W	SOLDERING IRON	470	 DF9103-M	SPECIALTY ALU FLAP DISC CLASSIC	532
 0027/40W	SOLDERING IRON	470	 DF9153-M	SPECIALTY ALU FLAP DISC CLASSIC	532
 0033A/TIP	SOLDERING IRON TIP SET	470	 ZTD8x	PROFESSIONAL ZIRCONIA CUTTING DISC	533
 0027/40W/TIP	SOLDERING IRON TIP SET	470	 ZSD8x	PROFESSIONAL ZIRCONIA GRINDING DISC	533

Art.	Desc.	Page
	MTP7x PROFESSIONAL CUTTING DISC FOR ALUMINIUM	534
	MTD7230/3.2 PROFESSIONAL CUTTING DISC FOR ALUMINIUM	534
	MSD7230/7.0 PROFESSIONAL GRINDING DISC FOR ALUMINIUM	534
	FDCx VIPER SEMI FLEXIBLE FIBER DISC	534
	MTP6x PERFORMANCE CUTTING DISC	534
	MTP4x STRONG CUT CUTTING DISC	535
	MTD4x STRONG CUT CUTTING DISC	535
	MSD4x STRONG CUT GRINDING DISC	535
	MVx GRINDING WHEEL	536
	MGx GRINDING WHEEL	536
	MBx GRINDING WHEEL	536
	MCGxA VITRIFIED MOUNTED POINTS	537
	MCGxS VITRIFIED MOUNTED POINTS	537
	MCG2050/06G VITRIFIED MOUNTED POINTS	537
	D040- DIAMOND CUP WHEEL	539
	D045- DIAMOND SAW BLADES CONTINUOUS RIM	539
	D070- PROFESSIONAL DIAMOND SAW BLADES FOR PORCELAIN GRES, TILES, HARD CERAMICS	539
	D060- PROFESSIONAL VENTILATED DIAMOND DISCS	539
	D059- VENTILATED DIAMOND SAW BLADES	539
	D055- PROFESSIONAL SEGMENTED VENTILATED DIAMOND DISCS	539
	D054- SEGMENTED VENTILATED DIAMOND DISCS	540
	AxSC SINGLE CUT ROTARY BURRS	541
	AxDC DIAMOND CUT ROTARY BURRS	541
	A12AL6 ROTARY BURRS FOR ALUMINIUM	541
	BxSC SINGLE CUT ROTARY BURRS	541

Art.	Desc.	Page
	BxDC DIAMOND CUT ROTARY BURRS	542
	BxAL ROTARY BURRS FOR ALUMINIUM	542
	BxSCxL SINGLE CUT LONG ROTARY BURRS	542
	BxDCxL CARBIDE ROTARY BURRS	542
	CxSC SINGLE CUT ROTARY BURRS	542
	CxDC DIAMOND CUT ROTARY BURRS	542
	CxAL ROTARY BURRS FOR ALUMINIUM	542
	DxSC SINGLE CUT ROTARY BURRS	542
	DxDC DIAMOND CUT ROTARY BURRS	543
	DxAL ROTARY BURRS FOR ALUMINIUM	543
	ExSC SINGLE CUT ROTARY BURRS	543
	ExDC DIAMOND CUT ROTARY BURRS	543
	ExAL ROTARY BURRS FOR ALUMINIUM	543
	FxSC SINGLE CUT ROTARY BURRS	543
	FxDC DIAMOND CUT ROTARY BURRS	543
	FxAL ROTARY BURRS FOR ALUMINIUM	543
	GxSC SINGLE CUT ROTARY BURRS	544
	GxDC DIAMOND CUT ROTARY BURRS	544
	GxAL ROTARY BURRS FOR ALUMINIUM	544
	HxSC SINGLE CUT ROTARY BURRS	544
	HxDC DIAMOND CUT ROTARY BURRS	544
	HxAL ROTARY BURRS FOR ALUMINIUM	544
	LxSC SINGLE CUT ROTARY BURRS	544
	LxDC DIAMOND CUT ROTARY BURRS	544
	L10AL6 ROTARY BURRS FOR ALUMINIUM	545

Art.	Desc.	Page
	MxSC SINGLE CUT ROTARY BURRS	545
	MxDC DIAMOND CUT ROTARY BURRS	545
	M10AL6 ROTARY BURRS FOR ALUMINIUM	545
	NxSC SINGLE CUT ROTARY BURRS	545
	N12DC6 DIAMOND CUT ROTARY BURRS	545
	JxSC SINGLE CUT ROTARY BURRS	545
	JxDC DIAMOND CUT ROTARY BURRS	545
	KxSC SINGLE CUT ROTARY BURRS	546
	KxDC DIAMOND CUT ROTARY BURRS	546
	F008DC HARD METAL ROTARY BURR SET	546
	F008SC HARD METAL ROTARY BURR SET	546
	MDAxZT FAST LOCK ZIRCONIA TOP SIZE	547
	MSCx FAST LOCK SURFACE CONDITIONING	547
	MDUx FAST LOCK UNITIZED	547
	MDFx FAST LOCK FELTRO	548
	RGTx ALUMINIUM OXIDE SHAFT-MOUNTED CLOTH WHEELS	549
	FRFx PAIR OF FLANGES	550
	NASx-Z ZIRCONIA CLOTH BELTS	552
	NASx-A ALUMINIUM OXIDE CLOTH BELTS	552
	NASx-C CERAMIC BELTS	552
	NATx TRIZACT BELTS	552
	SCSx SURFACE CONDITIONING BELTS	552
	RPW090 RUBBER PNEUMATIC WHEEL	552
	ERW100 CENTRIFUGAL EXPANDING WHEEL	553
	SWS100 BRASS STEEL WIRE WHEELS	553

Art.	Desc.	Page
	SWS100/M BRASS STEEL WIRE WHEELS	553
	NWS100 ABRASIVE NYLON WIRE WHEELS	553
	NWS100/M ABRASIVE NYLON WIRE WHEELS	553
	SRFx CIRCULAR BRUSHES	554
	STRx TWISTED KNOTS CUP BRUSHES	555
	SFPx TIP END BRUSHES	557
	BGAx ABRASIVE RUBBER BLOCKS	561
	RFF100 VENTILATED FELT WHEEL	563
	VDGx VELCRO DISCS "GOLD"	568
	PDVx-M14 BACKING PAD WITH VENTILATION	570
	TEV120 BLOCK FOR VELCRO DISCS	571
	TDV BLOCK FOR VELCRO DISCS	571
	RSSx ANTI-WASTE SPONGE ROLLS	571
	RSRx VELCRO PAPER ROLLS	571
	RSAx LUBRICANT VELCRO PAPER ROLLS	572
	FTRx FLEXIBLE CLOTH	572
	RTFx RESIN CLOTH ROLLS	572
	CRDxC CARTRIDGE ROLLS	574
	CRDxT CARTRIDGE ROLLS	574
	PCR6338 PIN FOR CARTRIDGE ROLLS	574
	NTxZ ABRASIVE BELTS	575

Within this catalog, new products are indicated with the symbol **CAT. 42**

The new references within a product range are instead indicated with the symbol ***CAT. 42**

Art.	Page #40	Substitute code	Page #42
0309/15	624		
0309/16	624		
0143	171	0143A	139
G101/11	635		
0309/21	624		
0309/12	624		
0489/2b	625		
0475	531		
0489/2s	626		
T026	59		
M750/315	192		
F008/K12	328	G12DC6	544
M770/315	193		
0410/19	641		
0410/06	641		
0326	644		
0489/4s	626		
0489/3s	626		
M750/250	192		
M770/200	193		
0489/4b	626		
M760/315	192		
0489/3b	626		
M770/160	193		
M770/400	193		
0410/04	640		
0532/230V	208	0532A/230V	174
M750/400	192		
M760/400	192		
0410/07	641		
0410/01	640		
0410/09	641		
M750/200	192		
0410/18	641		
0482/30	623		
0410/02	640		
F008/H12	328	F12DC6	543
0027	602	0027/30W	470
0410/05	640		
0346	615	0218/50B	483
0410/03	640		
M760/125	192		
F008/B12	328	B12DC6	542
M750/160	192		
F008/C10	328	C10DC6	542
0881/06009	491		
S464/10	617	0218/10S	484
202013.3	353		
0410/13	642		

Art.	Page #40	Substitute code	Page #42
M750/125	192		
0884/6150	491		
F008/B10	328	B10DC6	542
202420	353		
0410/08	641		
0885/2100	491		
0410/14	642		
0410/10	642		
0532	208	0532A	174
S450/20	616	0218/10B	483
601230	364		
202131.2	354		
F008/H10	328	F10DC6	543
F008/K10	328	G10DC6	544
0482/09	623		
0860	644		
0882/2100	491		
0410/15	642		
312476	357		
201101	355		
474471	360		
S464/20	617	0218/20S	484
S450/10	616	0218/20B	483
0882/1080	491		
201034	354		
320022	359		
202132.2	354		
142702	356		
231323	355		
0410/16	642		
312475	357		
322514.2	359		
142703	356		
320021	359		
231324	355		
202012.3	353		
0410/12	642		
M770/125	193		
202040.3	353		
0866	644		
F008/D10	328	D10DC6	543
336233	359		
0881/10020	491		
472030	356		
474454	360		
1012020100	352		
0881/08010	491		
350325	365		
312543	358		

Art.	Page #40	Substitute code	Page #42
1018020100	352		
312544	358		
312479	357		
312477	357		
350320	365		
0410/17	642		
F008/B06	328	B06DC6	542
334620	359		
F008/B08	328	B08DC6	542
260299	365		
201102	355		
504034.2	357		
F008/C06	328	C06DC6	542
S448/10	616	0218/10	483
312542	358		
202011.3	353		
0410/11	642		
712010	357		
231322	355		
504904.2	358		
201103	355		
202130.2	354		
0884/3075	491		
A003/13M	85	SPARE PART	
201058	354		
201024	354		
0661/N1	620	SPARE PART	
504803	358		
312456	357		
312459	357		
334614	360		
1033010020	352		
474404	363		
336230	359		
600148	363		
0536/L	209	SPARE PART	
471014	362		
640384	364		
201059	354		
413105	361		
474403	363		
600145	363		
336231	359		
322513.2	359		
312541	358		
231321	355		
0884/5125	491		
411007	361		
312474	357		

Art.	Page #40	Substitute code	Page #42
474401	362		
472115	362		
312473	357		
322512.2	359		
312455	357		
0882/3150	491		
1033010030	352		
312457	357		
1034010050	352		
455020	361		
455025	361		
312478	357		
504032.2	357		
1018020200	352		
1010020015	352		
1010020030	352		
455010	361		
413107	361		
322511.2	359		
0883/4100	491		
1018020050	352		
472116	362		
1012020050	352		
T092/P	371	SPARE PART	
472201	362		
472117	362		
411005	361		
E190/B1	483		
1018020030	352		
T100/500P	371	SPARE PART	
312458	357		
504033.2	357		
T100/300P	371	SPARE PART	
334629	359		
472202	362		
455005	361		
0885/1080	491		
F008/D06	328	D06DC6	543
504036.2	357		
312453	357		
455030	361		
0516/N	620	SPARE PART	
350321	365		
A040/A30	137	SPARE PART	
312454	357		
A040/A45	137	SPARE PART	
0534	209	SPARE PART	
455015	361		
A003/13	84	A003/13A	68

Art.	Page #40	Substitute code	Page #42
T024	65		
T061	41	T061A	35
0545/EM	438		
0545/TM	441		
0375	150	0375A	120
0033	602	0033A	470
M770/250	193		
0517	99	0517A	80
0383	82	S383	65
0538	209	0538A	174
M760/250	192		
M760/160	192		
0348	615	0218/50T	484
T017/110	180	T017/100	147
M760/200	192		
0537	209	0537A	174
S448/20	616	0218/20	483
0531	208	0531A	174
0435	134		
241420	356		
0539	209	SPARE PART	
WCMT080412234	292		
0884/8150	491		
0319	643		
0535	209	SPARE PART	
A040/A27	137		
0328	643		
0345	615	0218/50	483
0868	644		
0884/4100	491		
0314	643		
M063	405		
0172/180	607		
WCMT06T308234	292		
0651/5S	633		
M058	405		
0883/3075	491		
A040/A49	137		
0881/06006	491		
WCMT050308234	292		
0347/500	615		
0881/10025	491		
0881/06008	491		
0881/06007	491		
0761	644		
A040/A28	137	SPARE PART	
0885/3150	491		
A040/A50	137		
0881/08015	491		
0347/300	615		

Art.	Page #40	Substitute code	Page #42
0330	643		
0858	643		
A040/A26	137		
0881/11530	491		
0033/TIP1	602	SPARE PART	
0530/N	620	SPARE PART	
C960	558	C960/F7	422
C960B	559	C960/B7	423
MSD6350/3.0	257	MTP6350/3.0	534
0527	261	D060/230	539
0349	261	D060/115	539
0279	261	D045/115	539
RGT2215/60	262		
RGT2215/80	262		
RGT2215/120	262		
RGT8030/40	262		
RGT8030/60	262		
RGT8030/80	262		
RGT8030/120	262		
RGP040/30C	263		
RGP040/30M	263		
RGP040/30F	263		
RGP040/30VF	263		
RLF115/240	264		
RLF125/240	264		
DF6801.412	238		
DF6801.422	238		
DF6101.412	240		
DF6151.412	242		
RPMT1204MON	293		
P023/19A	303	P023/19	214
P023/25A	303	P023/25	214
N180	74	LB01/1140	258
N181	74	LB02/1140	258
N182	74	LB01/1435	258
N183	74	LB02/1435	258
N184	74	LB07/2100	258
N185	74	LB01/1735	258
N196	74	LB09/2450	258
E010/M05E	337		
E010/M06E	337		
E010/M08E	337		
E010/M10E	337		
E010/M12E	337		
E010/M14E	337		
RLP100/UF	265		
P006	141	P039	114
C030/R	171		
C030/C	171		
P006/PR	141	SPARE PART	



42
fervi.com

Printed January 2020

by COPTIP Industrie Grafiche - Via Gran Bretagna 50 Modena MO 41122
Graphic design & Photos: Stefano Mazzali Studio www.stefanomazzali.com







	LATHES, MILLS AND DRILLS
pag.004	— Bench lathes
pag.026	— Drilling milling machines
pag.040	— Floor drilling machines
pag.052	— Drill presses
pag.056	— Magnetic drills

	METAL WORKING MACHINERY
pag.059	— Saw benches
pag.063	— Bench grinders
pag.067	— Sharpeners
pag.069	— Belt sanders
pag.071	— Metal sheet machines

	WOOD WORKING MACHINERY
pag.076	— Wood working lathes
pag.079	— Combination machines
pag.084	— Mitre saw
pag.086	— Band saws
pag.091	— Belt sanders
pag.094	— Dust collectors

	MACHINERY FOR FINISHING
pag.096	— Sandblast cabinets
pag.107	— Cleaning tanks
pag.109	— Vacuum cleaners wet and dry
pag.112	— Marking

	PRESSES AND HYDRAULIC PUMPS
pag.115	— Hydraulic presses
pag.118	— Manual presses
pag.119	— Hydraulic pump units

	CAR AND MOTORCYCLE WORKSHOP
pag.120	— Hydraulic trolley jacks
pag.122	— Hydraulic cranes and engine stands
pag.123	— Oil collecting units
pag.123	— Winches
pag.125	— Battery chargers
pag.126	— Motorcycle and quad lifts
pag.128	— Trolleys

	LIFTING AND HANDLING
pag.129	— Hydraulic jacks
pag.130	— Trolleys
pag.133	— Cable hoists
pag.134	— Lifting accessories
pag.136	— Winches and tensioners
pag.137	— Pallet handling

PROFESSIONAL LATHE

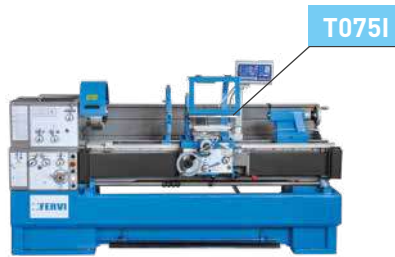
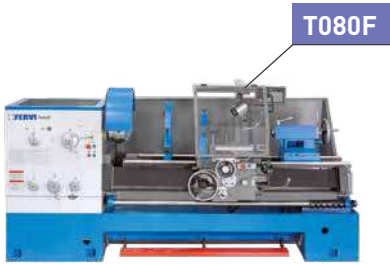

PROFESSIONAL LATHE

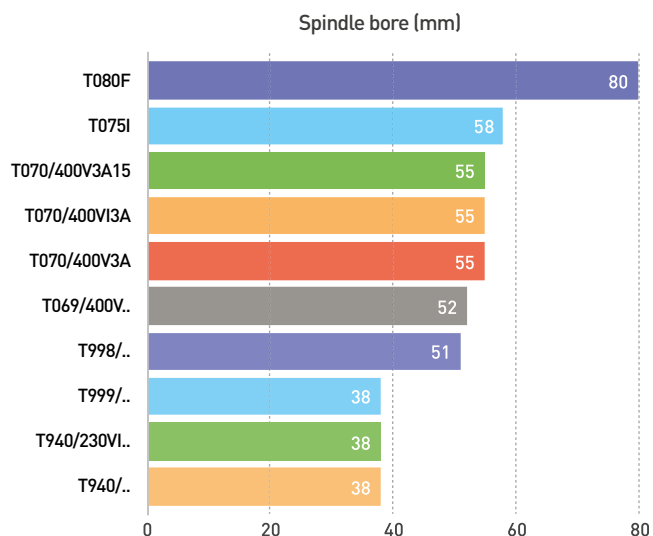
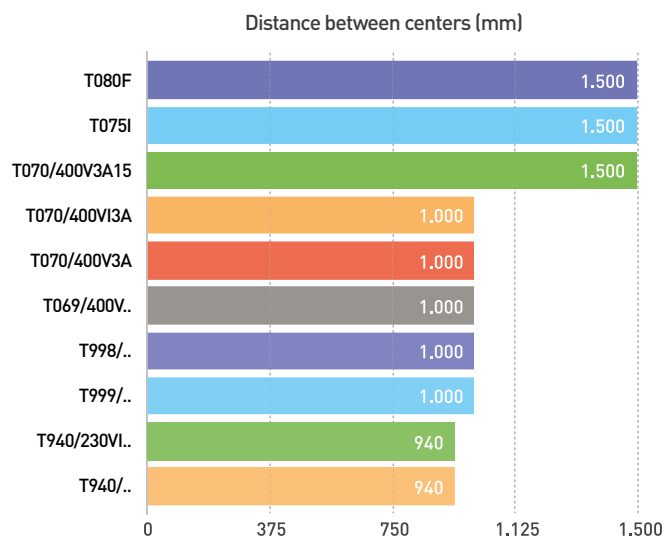
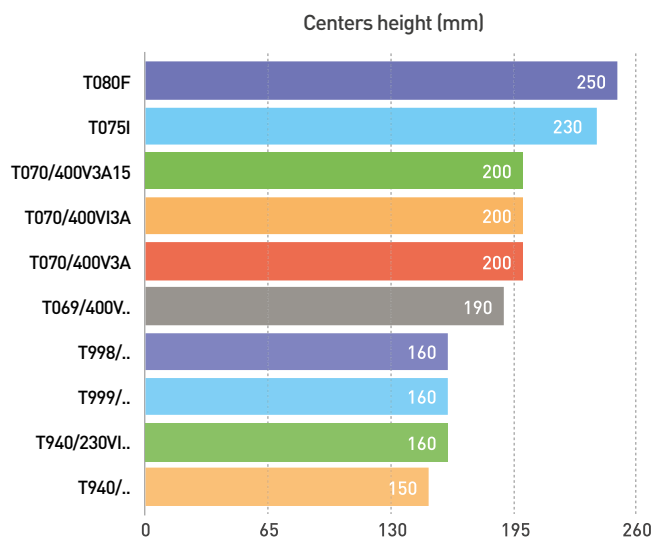
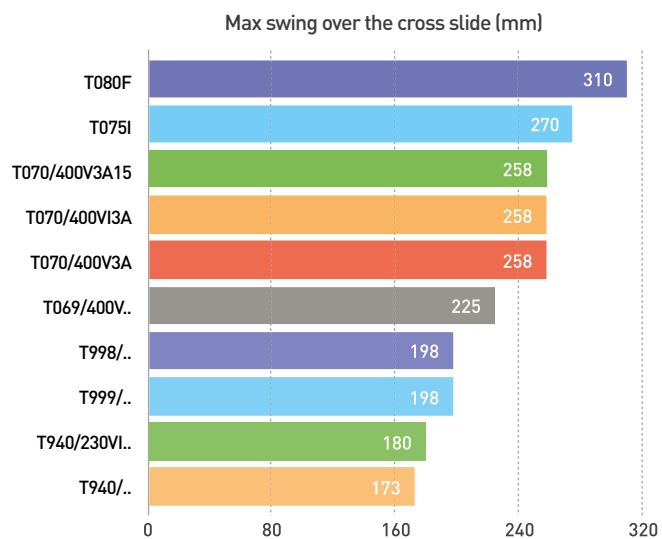
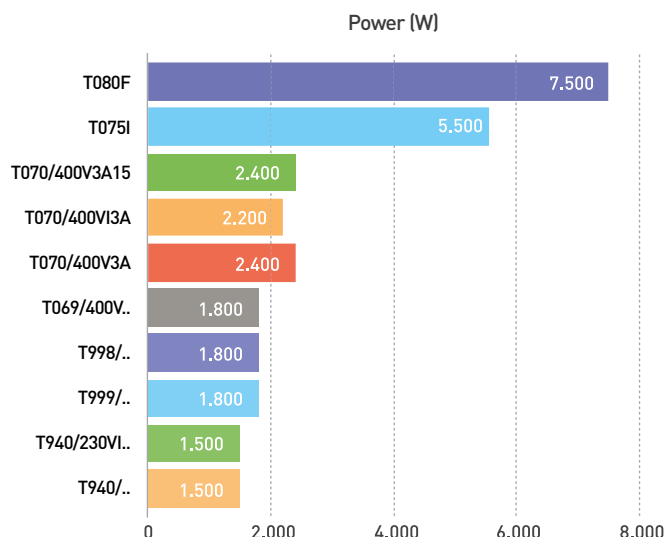
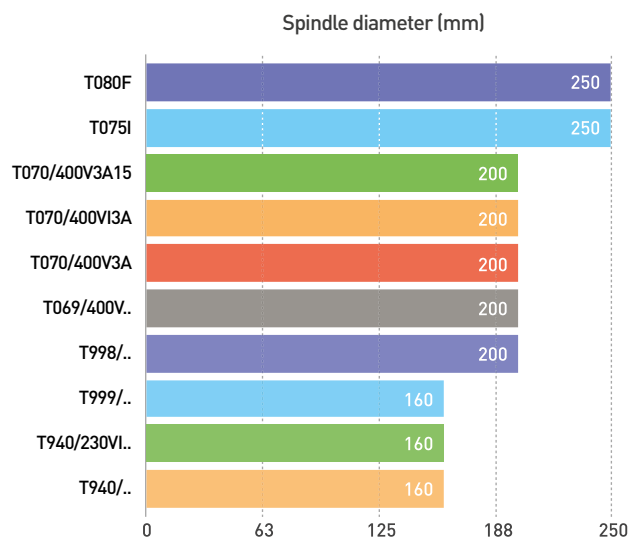

T080F

CAT. 42 € 38110,00

GEAR HEAD LATHE WITH READ OUT

WITH MECHANICAL SPINDLE CLUTCH AND 3 AXIS READ OUT, SEMI NORTON GEAR BOX

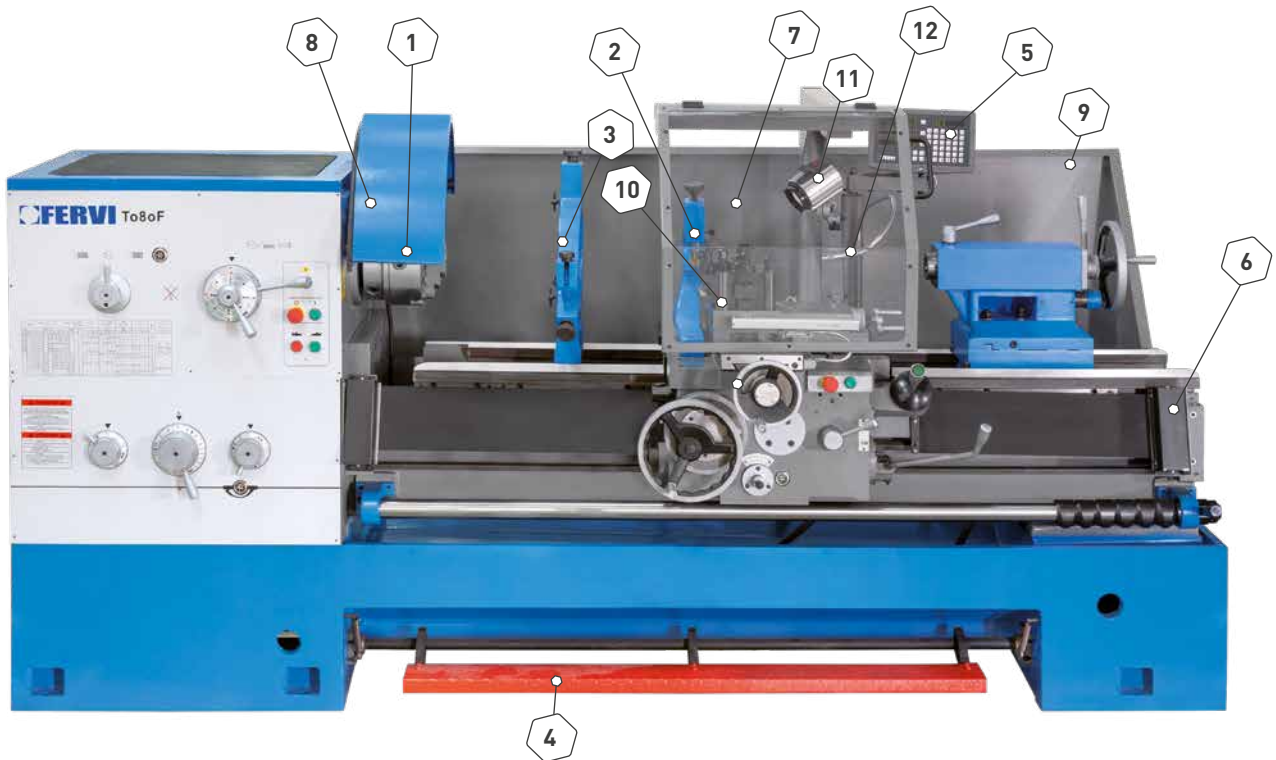

- 1 Self centering chuck 3+3 Ø 250 mm
- 2 Follow rest
- 3 Steady rest
- 4 Foot brake
- 5 3 Axis read out
- 6 Leadscrew hood

- 7 Tool post safeguard
- 8 Chuck safeguard
- 9 Full length splash guard
- 10 Quick change tool post
- 11 Working lamp
- 12 Cooling system

Centers height	250 mm
Max swing over the bed	500 mm
Max swing over the cross slide	310 mm
Max swing over the gap	720 mm
Distance between centers	1500 mm
Spindle bore	80 mm
Spindle nose Camlock	Camlock D1-8
Spindle taper MT	7
Approx spindle speeds	(12) 36 ÷ 1600 rpm
Longitudinal feeds mm/rev	0,063 ÷ 2,52
Cross feeds mm/rev	0,027 ÷ 1,07
Metric threads	1 ÷ 14 mm
Inch threads	2 ÷ 28 TPI
Tailstock taper MT	5
Three-phase motor	400V 50 Hz 7,5 kW
Net weight	3250 kg
Weight	3550 kg
Packing dimensions	2840 x 1150 x 1430h mm

INCLUDED ACCESSORIES

- 3 reversible jaw self centering chuck Ø 250 mm
- 4 independent jaw chuck Ø 320 mm
- Reduction sleeve MT 7/5
- Face plate Ø 400 mm
- Follow rest
- Steady rest
- Dead center MT 5
- Live center MT 5
- Foot brake
- Thread dial
- Leadscrew hood
- Chuck safeguard
- Full length splash guard
- Italy style quick change tool post type C
- Working lamp
- Cooling system

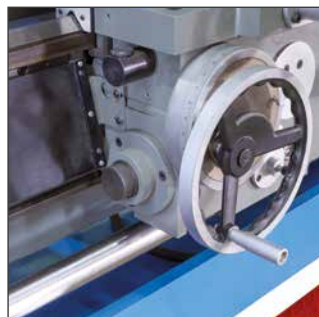

T075I

CAT. 42 € 29660,00

GEAR HEAD LATHE WITH INVERTER

3 AXIS READ OUT, SEMI NORTON GEAR BOX

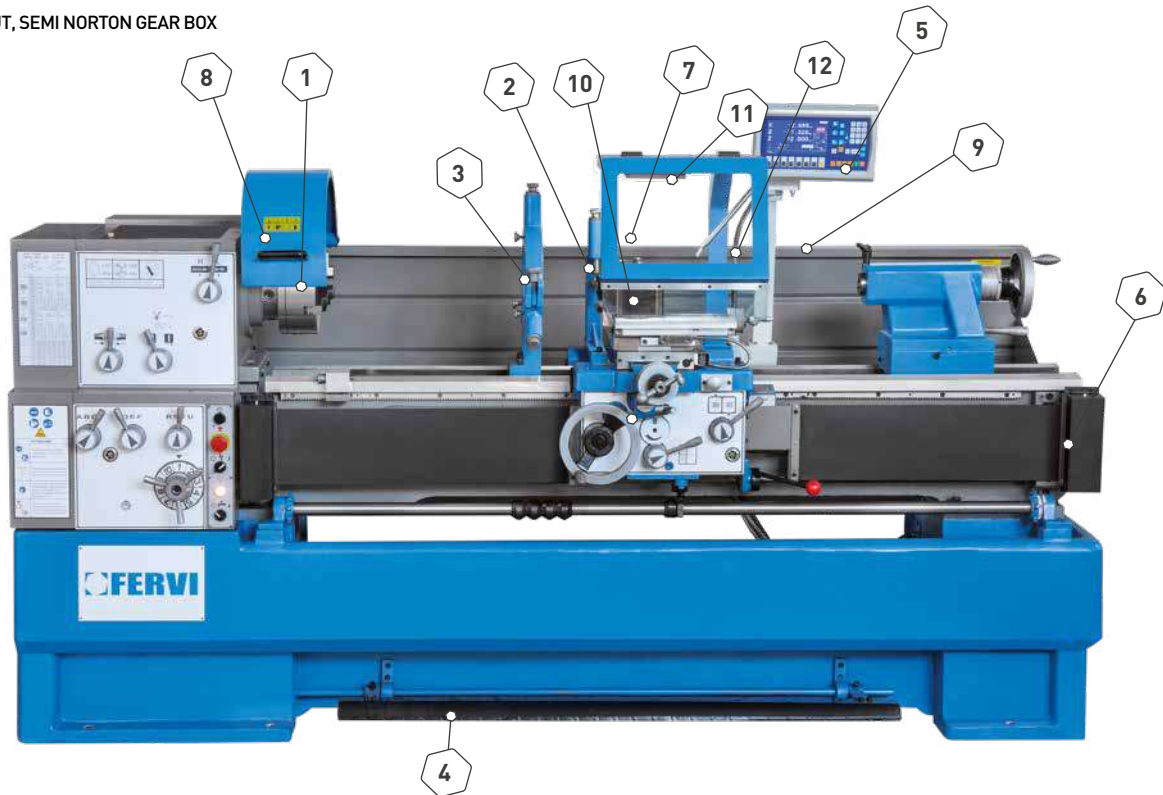

- 1 Self centering chuck 3+3 Ø 250 mm
- 2 Follow rest
- 3 Steady rest
- 4 Foot brake
- 5 3 Axis read out
- 6 Leadscrew hood

- 7 Tool post safeguard
- 8 Chuck safeguard
- 9 Full length splash guard
- 10 Quick change tool post
- 11 Working lamp
- 12 Cooling system

Japan inverter with chuck speed adjustment	(2) 30 ÷ 600 - 600 ÷ 2000 rpm
Centers height	230 mm
Max swing over the bed	460 mm
Max swing over the gap	690 mm
Max swing over the cross slide	270 mm
Max length of workpiece	1500 mm
Spindle taper MT	6
Spindle bore	58 mm
Spindle nose Camlock	Camlock D1-6
Longitudinal feeds mm/rev	0,014 ÷ 0,784
Cross feeds mm/rev	0,031 ÷ 1,7
Metric threads	0,1 ÷ 14 mm
Inch threads	2 ÷ 112 TPI
Tailstock taper MT	4
Three-phase motor	400V 50/60 Hz 5,5 kW
Net weight	1970 kg
Weight	2270 kg
Packing dimensions	2840 x 1150 x 1430 mm

INCLUDED ACCESSORIES

3+3 jaw self centering chuck Ø 250 mm
 4 independent jaw chuck Ø 250 mm
 Dead center MT 4
 Live center MT 4
 Reduction sleeve MT 6/4
 Face plate Ø 350 mm
 Follow rest
 Steady rest
 Foot brake
 Thread dial
 Leadscrew hood
 Chuck safeguard
 Full length splash guard
 Quick change tool post type B
 Working lamp
 Cooling system

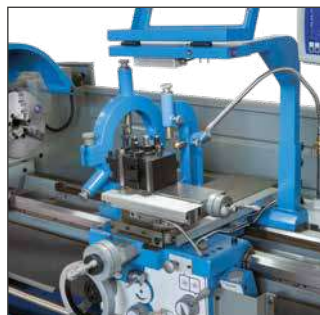

T070/400V3A15

CAT. 42 € 12830,00

GEAR HEAD LATHE WITH READ OUT

WITH 2 SPEED MOTOR AND 3 AXIS READ OUT, SEMI NORTON GEAR BOX

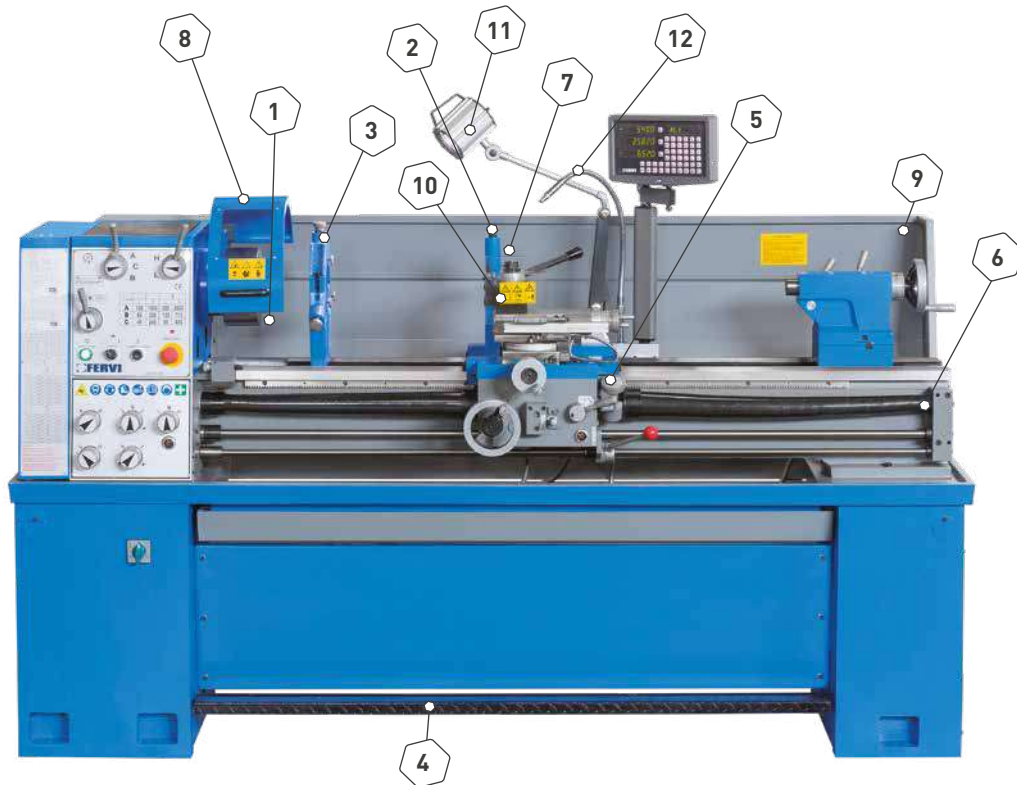

- 1 Self centering chuck 3+3 Ø 200 mm
- 2 Follow rest
- 3 Steady rest
- 4 Foot brake
- 5 Thread dial
- 6 Leadscrew hood
- 7 Tool post safeguard
- 8 Chuck safeguard
- 9 Full length splash guard
- 10 TOAE quick change tool post
- 11 Working lamp
- 12 Cooling system

Centers height	200 mm
Max swing over the bed	400 mm
Max swing over the cross slide	258 mm
Distance between centers	1500 mm
Spindle bore	55 mm
Spindle nose Camlock	Camlock D1-5
Spindle taper MT	6
Approx spindle speeds	(12) 45 ÷ 2000 rpm
Longitudinal feeds mm/rev	0,06 ÷ 2,78
Cross feeds mm/rev	0,01 ÷ 0,72
Metric threads	0,8 ÷ 14 mm
Inch threads	2 ÷ 28 TPI
Tailstock taper MT	4
Three-phase motor	400V 50 Hz 1,5 / 2,4 kW
Weight	850 kg
Packing dimensions	2430 x 760 x 1450h mm

INCLUDED ACCESSORIES

- 3+3 jaw self centering chuck Ø 200 mm
- 4 independent jaw chuck Ø 200 mm
- Reduction sleeve MT 6/4
- Face plate Ø 320 mm
- Follow rest
- Steady rest
- Dead center MT 4
- Live center MT 4
- Foot brake
- Thread dial
- Leadscrew hood
- Chuck safeguard
- Full length splash guard
- TOAE quick change tool post
- Working lamp
- Cooling system



T070/400VI3A

CAT. 42 € 13170,00

GEAR HEAD LATHE WITH INVERTER

3 AXIS READ OUT AND SEMI NORTON GEAR BOX

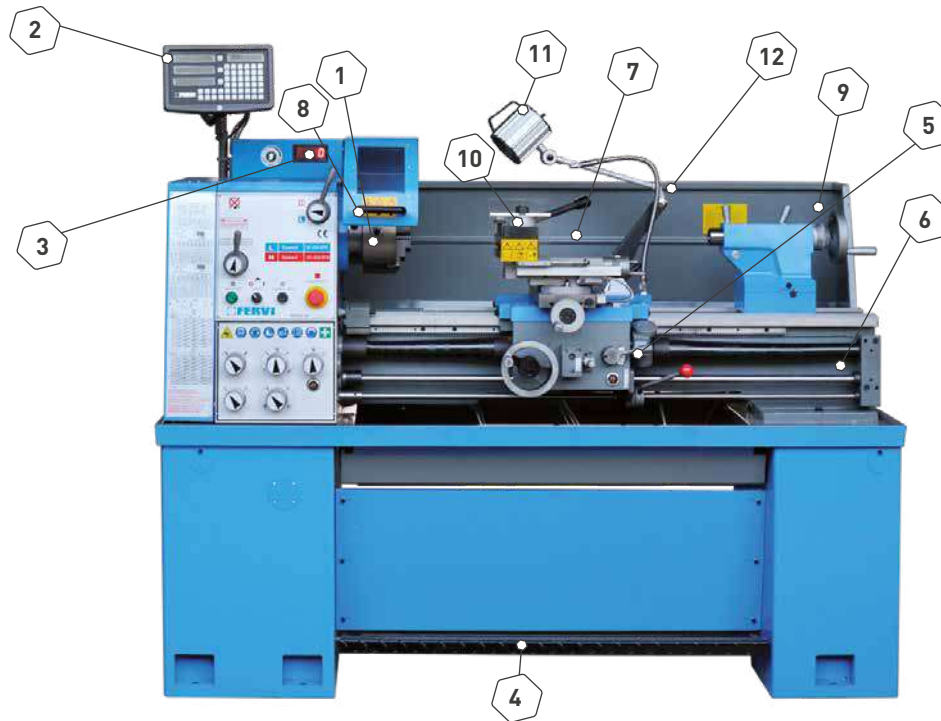

- 1 Self centering chuck 3+3 Ø 200 mm
- 2 3 Axis read out
- 3 Speed selector
- 4 Foot brake
- 5 Thread dial
- 6 Leadscrew hood

- 7 Tool post safeguard
- 8 Chuck safeguard
- 9 Full length splash guard
- 10 TOAB quick change tool post
- 11 Working lamp
- 12 Cooling system

Japan inverter with chuck speed adjustment	(2) 50 ÷ 1000 / 50 ÷ 2000 rpm
Centers height	200 mm
Max swing over the bed	400 mm
Max swing over the cross slide	258 mm
Max swing over the gap	550 mm
Max length of workpiece	1000 mm
Spindle bore	55 mm
Spindle taper	Camlock D1-5
Spindle taper MT	6
Longitudinal feeds mm/rev	0,06 ÷ 2,78
Cross feeds mm/rev	0,01 ÷ 0,72
Metric threads	0,8 ÷ 14 mm
Inch threads	2 ÷ 28 TPI
Tailstock taper MT	4
Three-phase motor	400V 2,2 kW
Net weight	700 kg
Packing dimensions	1930 x 760 x 1600h mm
Weight	800.00 kg

ACCESSORIES INCLUDED

3+3 jaw self centering chuck Ø 200 mm
 4 independent jaw chuck Ø 200 mm
 Reduction sleeve MT 6/4
 Face plate Ø 320 mm
 Face plate Ø 320 mm
 Follow rest
 Steady rest
 Dead center MT 4
 Foot brake
 Thread dial
 Leadscrew hood
 Chuck safeguard
 TOAB quick change tool post
 Working lamp
 Cooling system



T070/400V3A

€ 11890,00

GEAR HEAD LATHE WITH READ OUT

WITH 2 SPEED MOTOR AND 3 AXIS READ OUT, SEMI NORTON GEAR BOX

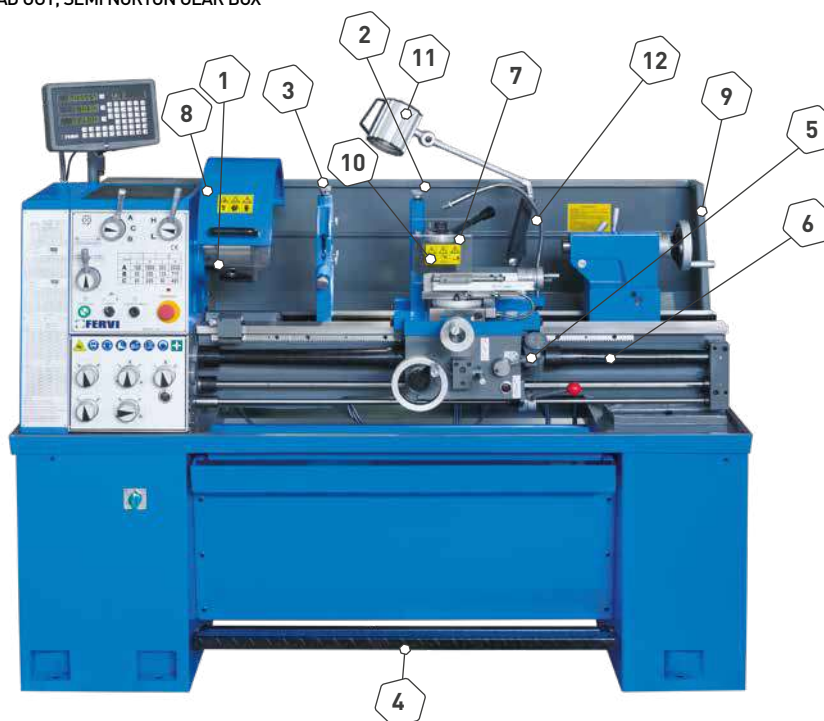

- 1 Self centering chuck 3+3 Ø 200 mm
- 2 Follow rest
- 3 Steady rest
- 4 Foot brake
- 5 Thread dial
- 6 Leadscrew hood

- 7 Tool post safeguard
- 8 Chuck safeguard
- 9 Full length splash guard
- 10 TOAE quick change tool post
- 11 Working lamp
- 12 Cooling system

Centers height	200 mm
Max swing over the bed	400 mm
Max swing over the cross slide	258 mm
Max swing over the gap	550 mm
Distance between centers	1000 mm
Spindle bore	55 mm
Spindle nose Camlock	Camlock D1-5
Spindle taper MT	6
Approx spindle speeds	(12) 45 ÷ 2000 rpm
Longitudinal feeds mm/rev	0,06 ÷ 2,78
Cross feeds mm/rev	0,01 ÷ 0,72
Metric threads	0,8 ÷ 14 mm
Inch threads	2 ÷ 28 TPI
Tailstock taper MT	4
Three-phase motor	400V 50 Hz 1,5 / 2,4 kW
Weight	800 kg
Packing dimensions	1930 x 760 x 1600h mm

INCLUDED ACCESSORIES

3+3 jaw self centering chuck Ø 200 mm
 4 independent jaw chuck Ø 200 mm
 Reduction sleeve MT 6/4
 Face plate Ø 320 mm
 Follow rest
 Steady rest
 Dead center MT 4
 Live center MT 4
 Foot brake
 Thread dial
 Leadscrew hood
 Chuck safeguard
 Full length splash guard
 TOAE quick change tool post
 Working lamp
 Cooling system



T069/400VI3A

CAT. 42 € 10750,00

INVERTER GEAR HEAD LATHE

3 AXIS READ OUT AND SEMI NORTON GEAR BOX

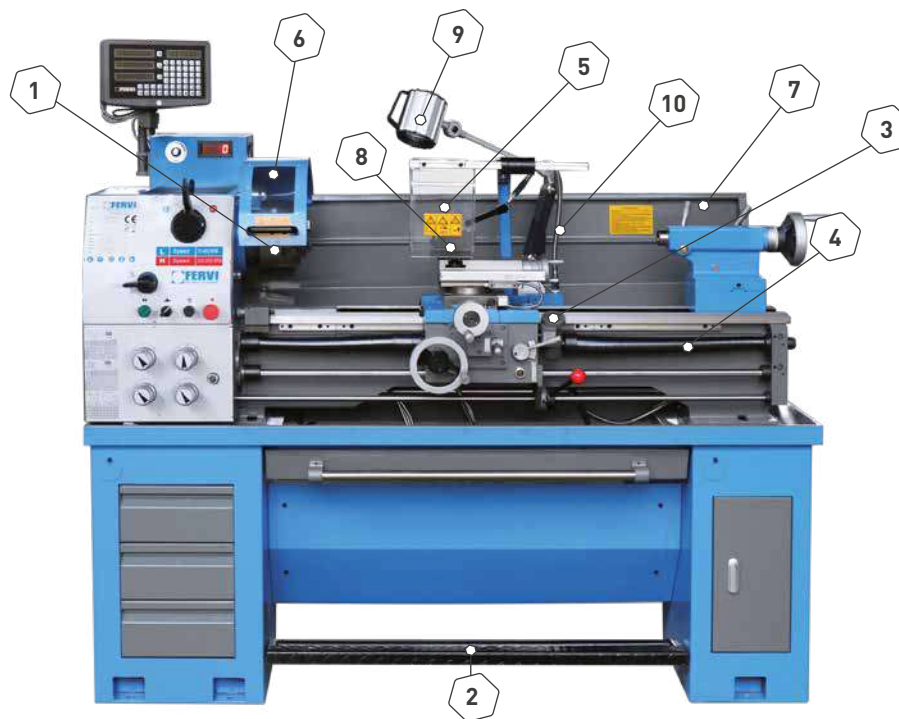

- 1 Self centering chuck 3+3 Ø 200 mm
- 2 Foot brake
- 3 Thread dial
- 4 Leadscrew hood
- 5 Tool post safeguard

- 6 Chuck safeguard
- 7 Full length splash guard
- 8 TOAE quick change tool post
- 9 Working lamp
- 10 Cooling system

Japan inverter with chuck speed adjustment	(2) 70 ÷ 400 / 50 ÷ 2000 rpm
Centers height	190 mm
Max swing over the bed	380
Max swing over the cross slide	225
Max swing over the gap	503
Max length of workpiece	1000
Spindle bore	51
Spindle taper	Camlock D1-5
Spindle taper MT	6
Longitudinal feeds mm/rev	0,052 - 1,392
Cross feeds mm/rev	0,014 - 0,380
Metric threads	0,4 - 7 mm
Inch threads	4 - 56 TPI
Tailstock taper MT	4
Three-phase motor	400V 1,5 kW
Net weight	550 kg
Packing dimensions	1930 x 760 x 1600h mm
Weight	650 kg

ACCESSORIES INCLUDED

3+3 jaw self centering chuck Ø 200 mm
 4 Reversible independent jaws chuck Ø 200 mm
 Reduction sleeve MT 6/4
 Face plate Ø 320 mm
 Follow rest
 Steady rest
 Dead center MT 4
 Live center MT 4
 Foot brake
 Thread dial
 Leadscrew hood
 Chuck safeguard
 Full length splash guard
 TOAE quick change tool post
 Working lamp
 Cooling system

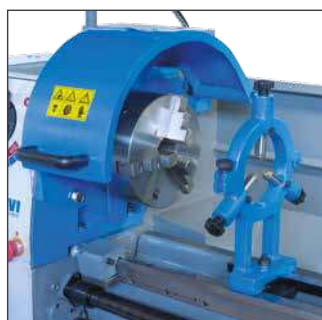
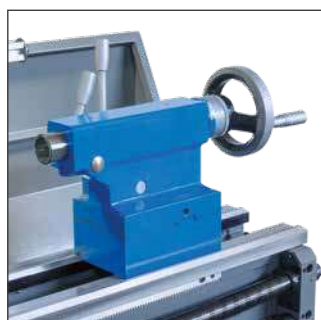

T069/400V3A

€ 9700,00

GEAR HEAD LATHE WITH READ OUT

3 AXIS READ OUT AND SEMI NORTON GEAR BOX

T069/400V

€ 8840,00

WITHOUT READ OUT



- 1 Self centering chuck 3+3 Ø 200 mm
- 2 Follow rest
- 3 Steady rest
- 4 Foot brake
- 5 Thread dial
- 6 Leadscrew hood

- 7 Tool post safeguard
- 8 Chuck safeguard
- 9 Full length splash guard
- 10 TOAE quick change tool post
- 11 Working lamp
- 12 Cooling system

Centers height	190 mm
Max swing over the bed	380 mm
Max swing over the cross slide	225 mm
Max swing over the gap	503 mm
Distance between centers	1000 mm
Spindle bore	52 mm
Spindle nose Camlock	Camlock D1-5
Spindle taper MT	6
Approx spindle speeds	70 ÷ 2000 rpm
Longitudinal feeds mm/rev	0,052 ÷ 1,392
Cross feeds mm/rev	0,014 ÷ 0,380
Metric threads	0,4 ÷ 7 mm
Inch threads	4 ÷ 56 TPI
Tailstock taper MT	4
Three-phase motor	400V 50 Hz 1,5 kW
Weight	650 kg
Packing dimensions	1930 x 760 x 1600h mm

INCLUDED ACCESSORIES

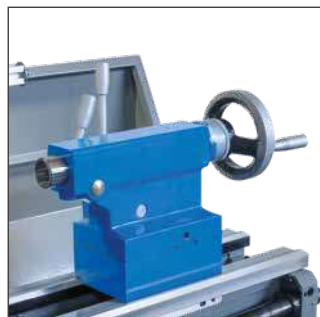
3+3 jaw self centering chuck Ø 200 mm
 4 Reversible independent jaws chuck Ø 200 mm
 Reduction sleeve MT 6/4
 Face plate Ø 320 mm
 Follow rest
 Steady rest
 Dead center MT 4
 Live center MT 4
 Foot brake
 Thread dial
 Leadscrew hood
 Chuck safeguard
 Full length splash guard
 TOAE quick change tool post
 Working lamp
 Cooling system



T998/400VI3A

CAT. 42 € 9830,00

INVERTER GEAR HEAD LATHE WITH READ OUT

3 AXIS READ OUT, SEMI NORTON GEAR BOX

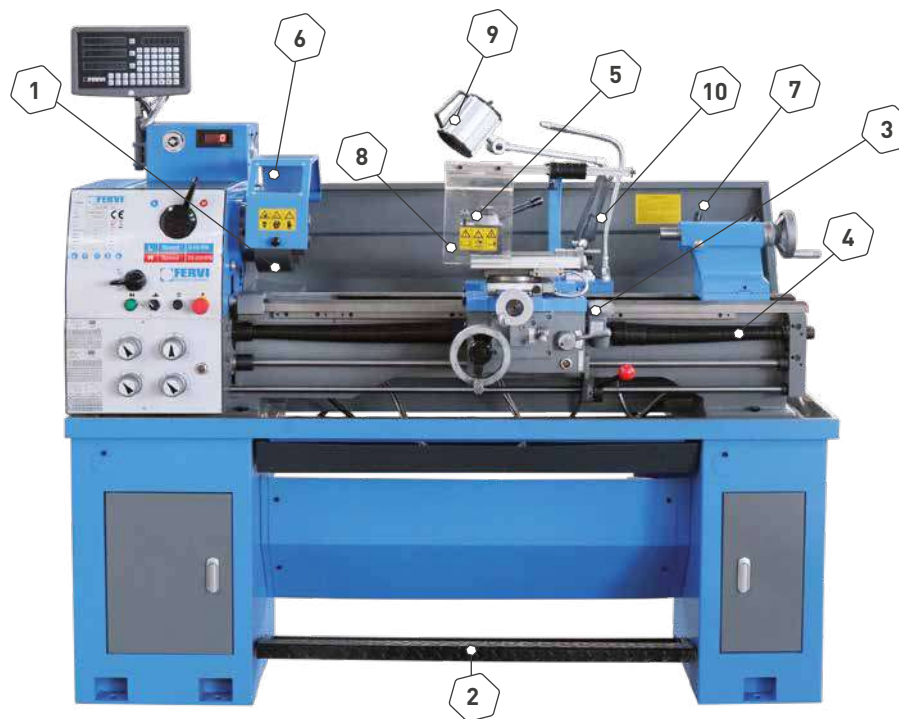

- 1 Self centering chuck 3+3 Ø 200 mm
- 2 Foot brake
- 3 Thread dial
- 4 Leadscrew hood
- 5 Tool post safeguard

- 6 Chuck safeguard
- 7 Full length splash guard
- 8 T0AE quick change tool post
- 9 Working lamp
- 10 Cooling system

Japan inverter with chuck speed adjustment	(2) 70 ÷ 400 / 350 ÷ 2000 rpm
Centers height	160 mm
Max swing over the bed	320 mm
Max swing over the cross slide	198 mm
Max swing over the gap	470 mm
Max length of workpiece	1000 mm
Spindle bore	51 mm
Spindle taper	Camlock D1-5
Spindle taper MT	5
Longitudinal feeds mm/rev	0.052 ÷ 1.392
Cross feeds mm/rev	0.009 ÷ 0.253
Metric threads	0,4 ÷ 7 mm
Inch threads	4 ÷ 56 TPI
Tailstock taper MT	3
Three-phase motor	400V 1,5 kW
Net weight	550 kg
Packing dimensions	1930 x 760 x 1600h mm
Weight	650 kg

ACCESSORIES INCLUDED

3+3 jaw self centering chuck Ø 200 mm
 4 Reversible independent jaws chuck Ø 200 mm
 Reduction sleeve MT 5/3
 Face plate Ø 250 mm
 Follow rest
 Steady rest
 Dead center MT 3
 Live center MT 3
 Foot brake
 Thread dial
 Leadscrew hood
 Chuck safeguard
 Full length splash guard
 T0AE quick change tool post
 Working lamp
 Cooling system



T998/230V3A & T998/400V3A

€ 8760,00

GEAR HEAD LATHE WITH READ OUT

3 AXIS READ OUT, SEMI NORTON GEAR BOX

T998/230V & T998/400V

€ 7940,00

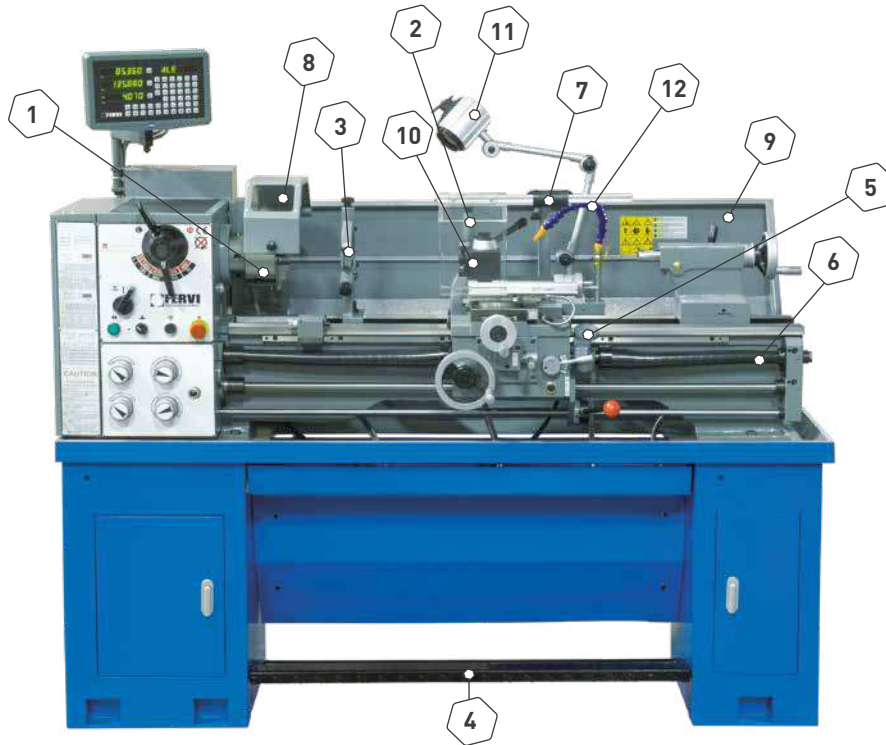
WITHOUT READ OUT

- 1 Self centering chuck 3+3 Ø 200 mm
- 2 Follow rest
- 3 Steady rest
- 4 Foot brake
- 5 Thread dial
- 6 Leadscrew hood

- 7 Tool post safeguard
- 8 Chuck safeguard
- 9 Full length splash guard
- 10 TOAE quick change tool post
- 11 Working lamp
- 12 Cooling system

Centers height	160 mm
Max swing over the bed	320 mm
Max swing over the cross slide	198 mm
Max swing over the gap	470 mm
Distance between centers	1000 mm
Spindle bore	51 mm
Spindle nose Camlock	Camlock D1-5
Spindle taper MT	5
Approx spindle speeds	(8) 70 ÷ 2000 rpm
Longitudinal feeds mm/rev	0.052 ÷ 1.392
Cross feeds mm/rev	0.009 ÷ 0.253
Metric threads	0,4 ÷ 7 mm
Inch threads	4 ÷ 56 TPI
Tailstock taper MT	3
Motor	1.8kW 50Hz 230V 1.5kW 50Hz 400V
Weight	630 kg

INCLUDED ACCESSORIES

3+3 jaw self centering chuck Ø 200 mm
 4 Reversible independent jaws chuck Ø 200 mm
 Reduction sleeve MT 5/3
 Face plate Ø 250 mm
 Follow rest
 Steady rest
 Live center MT 3
 Foot brake
 Thread dial
 Leadscrew hood
 Chuck safeguard
 Full length splash guard
 TOAE quick change tool post
 Working lamp
 Cooling system



T999/230V3A & T999/400V3A

€ 8370,00

GEAR HEAD LATHE WITH READ OUT

3 AXIS READ OUT, SEMI NORTON GEAR BOX

T999/400V & T999/230V

€ 7340,00

WITHOUT READ OUT

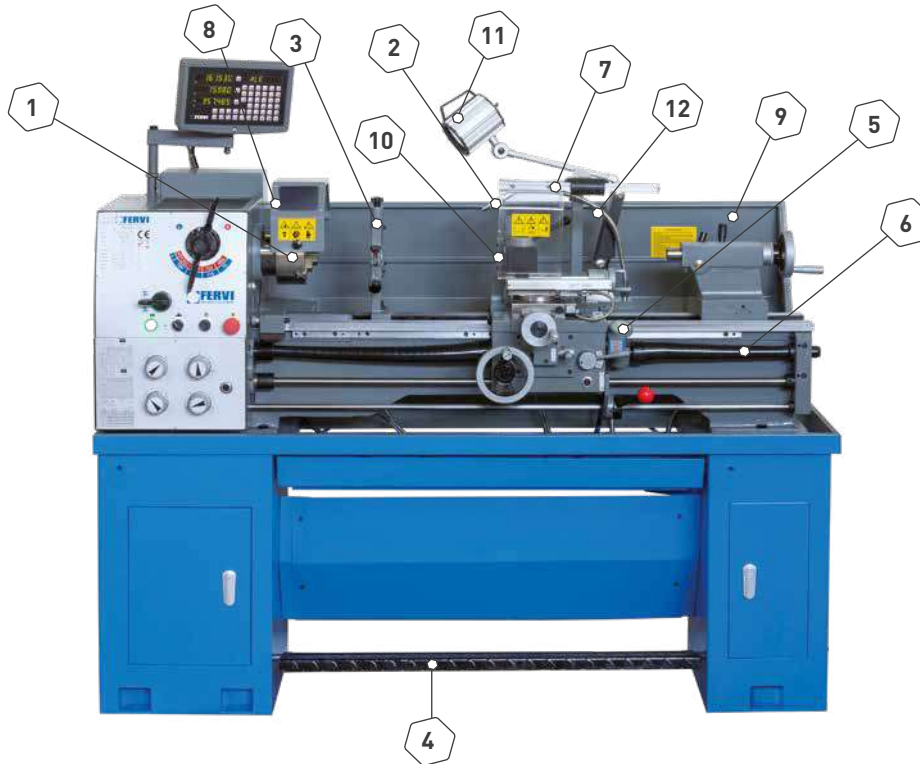

- 1 Self centering chuck 3+3 Ø 160 mm
- 2 Follow rest
- 3 Steady rest
- 4 Foot brake
- 5 Thread dial
- 6 Leadscrew hood
- 7 Tool post safeguard
- 8 Chuck safeguard
- 9 Full length splash guard
- 10 T0AE quick change tool post
- 11 Working lamp
- 12 Cooling system

Centers height	160 mm
Max swing over the bed	320 mm
Max swing over the cross slide	198 mm
Max swing over the gap	470 mm
Distance between centers	1000 mm
Spindle bore	38 mm
Spindle nose Camlock	Camlock D1-4
Spindle taper MT	5
Approx spindle speeds	{8} 70 ÷ 2000 rpm
Longitudinal feeds mm/rev	0,052 ÷ 1,392
Cross feeds mm/rev	0,009 ÷ 0,253
Metric threads	0,4 ÷ 7 mm
Inch threads	4 ÷ 56 TPI
Tailstock taper MT	3
Motor	1.8kW 50Hz 230V 1.5kW 50Hz 400V
Weight	615 kg
Packing dimensions	1980 x 750 x 1450h mm

INCLUDED ACCESSORIES

- 3+3 jaw self centering chuck Ø 160 mm
- 4 Reversible independent jaws chuck Ø 200 mm
- Reduction sleeve MT 5/3
- Face plate Ø 250 mm
- Follow rest
- Steady rest
- Live center MT 3
- Foot brake
- Thread dial
- Leadscrew hood
- Chuck safeguard
- Full length splash guard
- T0AE quick change tool post
- Working lamp
- Cooling system



T940/230VI3A

€ 8410,00

GEAR HEAD LATHE WITH INVERTER

3 AXIS READ OUT, SEMI NORTON GEAR BOX

T940/230VI

€ 7300,00

WITHOUT READ OUT

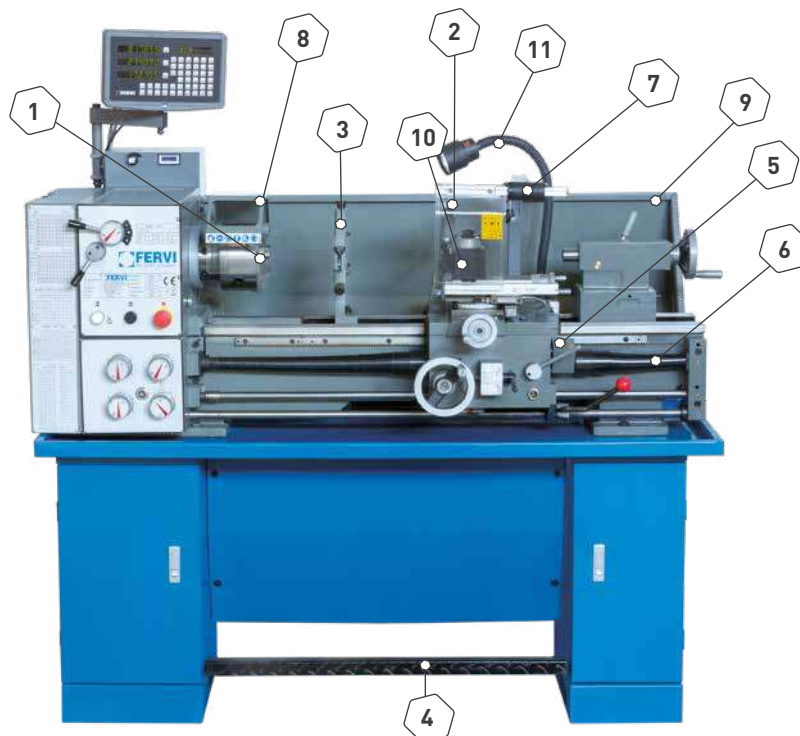

- 1 Self centering chuck 3+3 Ø 160 mm
- 2 Follow rest
- 3 Steady rest
- 4 Foot brake
- 5 Thread dial

- 6 Leadscrew hood
- 7 Tool post safeguard
- 8 Chuck safeguard
- 9 Full length splash guard
- 10 TOAE quick change tool post
- 11 Working lamp

Japan inverter with chuck speed adjustment	70 ÷ 1700 rpm
Centers height	160 mm
Max swing over the bed	320 mm
Max swing over the gap	460 mm
Max swing over the cross slide	180 mm
Max length of workpiece	940 mm
Spindle taper MT	5
Spindle bore	38 mm
Spindle nose Camlock	Camlock D1-4
Longitudinal feeds mm/rev	0,053 ÷ 1,291
Cross feeds mm/rev	0,011 ÷ 0,276
Metric threads	0,4 ÷ 7 mm
Inch threads	4 ÷ 60 TPI
Tailstock taper MT	3
Three-phase motor	230V 1,5 kW
Single phase power supply	200-240 V 50 / 60 Hz
Lathe dimensions	650 x 1570 x 1300 mm
Weight	465 kg
Packing dimensions	750 x 1640 x 1500 mm

INCLUDED ACCESSORIES

- 3+3 jaw self centering chuck Ø 160 mm
- 4 independent jaw chuck Ø 200 mm
- Dead center MT 5
- Dead center MT 3
- Live center MT 3
- Reduction sleeve MT 5/3
- Face plate Ø 240 mm
- Back plate Ø 200 mm
- Follow rest
- Steady rest
- Foot brake
- Thread dial
- Leadscrew hood
- Chuck safeguard
- Full length splash guard
- TOAE quick change tool post
- Working lamp

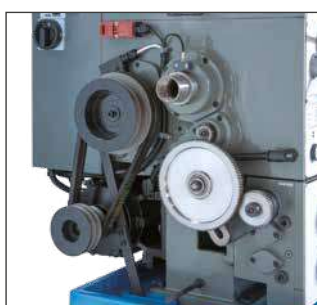

T940/230V & T940/400V

€ 6180,00

GEAR HEAD LATHE

SEMI NORTON GEAR BOX

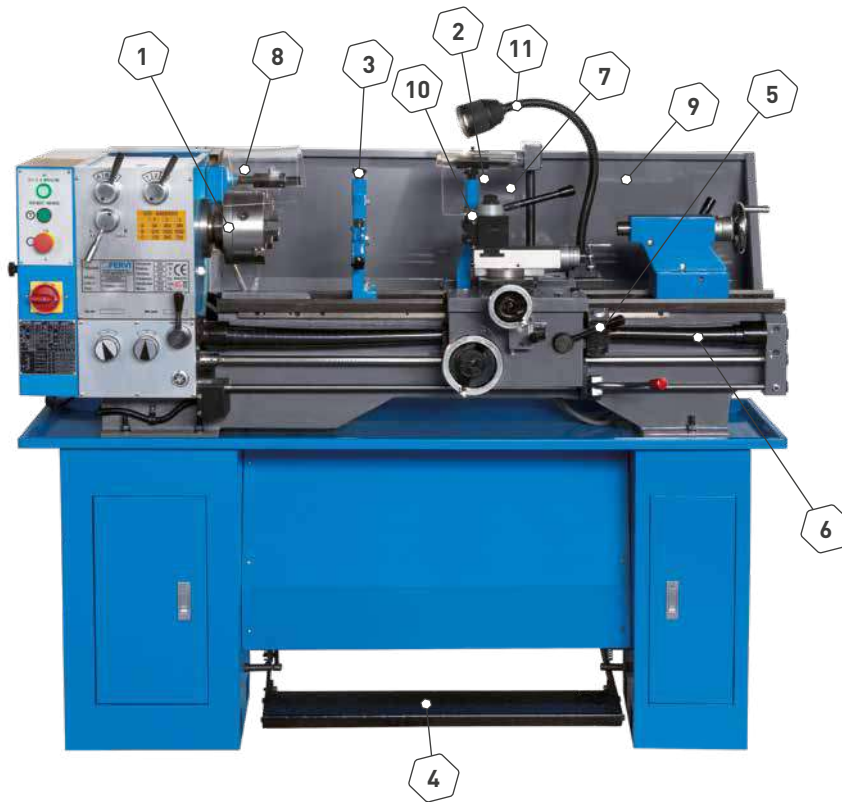

- 1 Self centering chuck 3+3 Ø 160 mm
- 2 Follow rest
- 3 Steady rest
- 4 Foot brake
- 5 Thread dial

- 6 Leadscrew hood
- 7 Tool post safeguard
- 8 Chuck safeguard
- 9 Full length splash guard
- 10 TOAE quick change tool post
- 11 Working lamp

Centers height	150 mm
Max swing over the bed	300 mm
Max swing over the gap	480 mm
Max swing over the cross slide	173 mm
Max length of workpiece	940 mm
Spindle taper MT	5
Spindle bore	38 mm
Approx spindle speeds	(9) 64 ÷ 1500 rpm
Longitudinal feeds mm/rev	0,051 ÷ 0,303
Cross feeds mm/rev	0,051 ÷ 0,303
Metric threads	0,5 ÷ 3,5 mm
Inch threads	7,5 ÷ 48 TPI
Tailstock taper MT	3
Motor	230 V 50 Hz 1,5 kW 400 V 50 Hz 1,1 kW
Lathe dimensions	600 x 1600 x 1270 mm
Weight	465 kg
Packing dimensions	740 x 1780 x 1460 mm

INCLUDED ACCESSORIES

3+3 jaw self centering chuck Ø 160 mm
 4 Reversible independent jaws chuck Ø 200 mm
 Dead center CM/MT 3
 Live center CM/MT 3
 Reduction sleeve CM/MT 5/3
 Face plate Ø 240 mm
 Back plate Ø 200 mm
 Follow rest
 Steady rest
 Foot brake
 Thread dial
 Leadscrew hood
 Chuck safeguard
 Full length splash guard
 TOAE quick change tool post
 Working lamp



LATHES

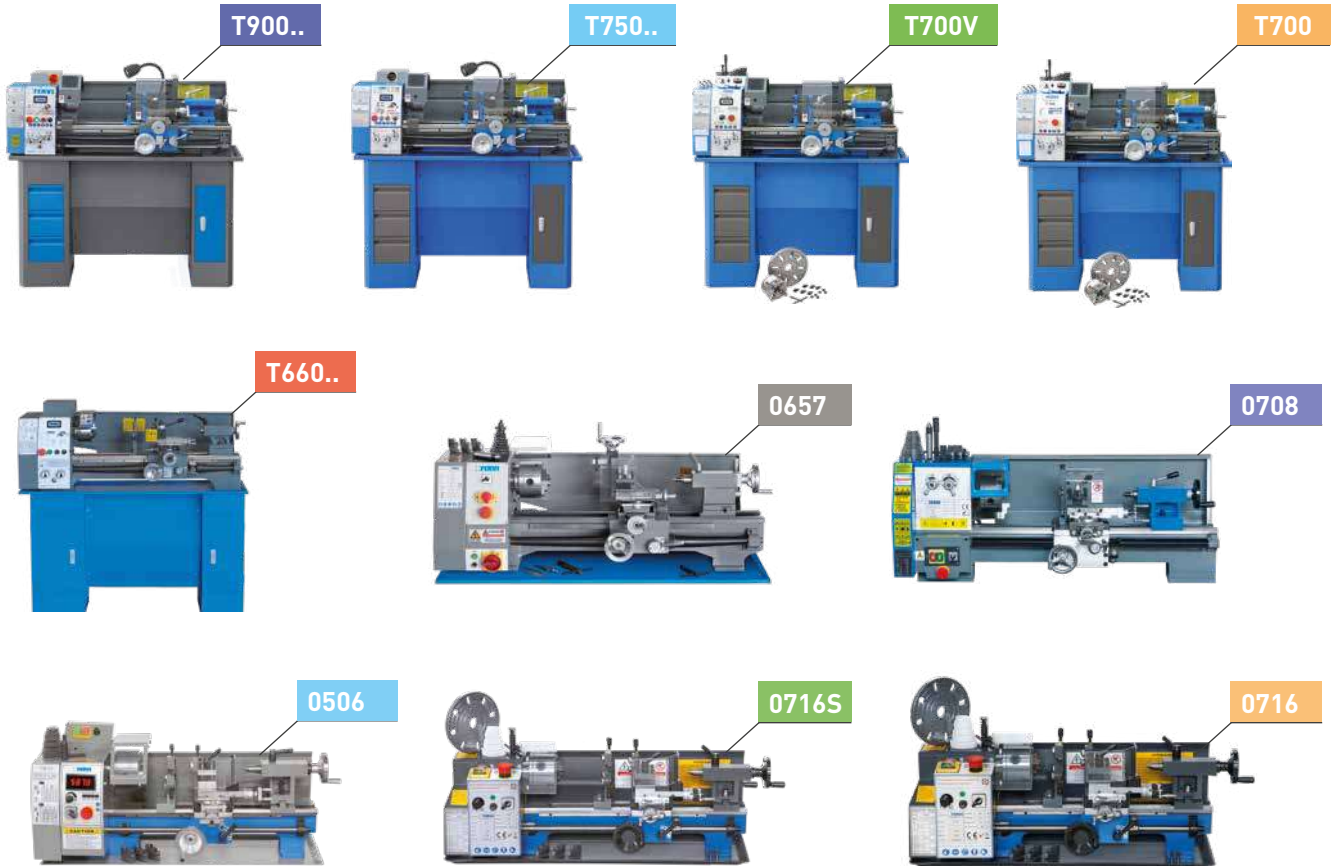

Spindle diameter (mm)

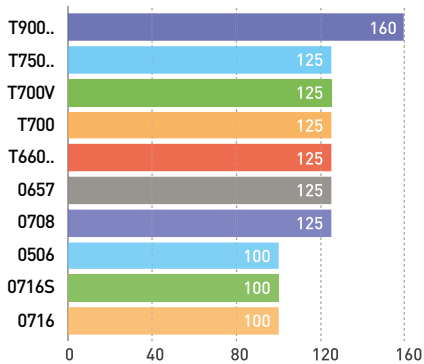

Power (W)

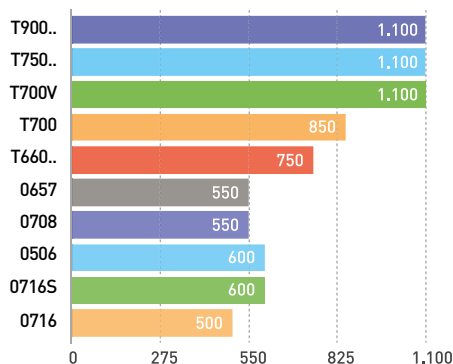

Max swing over the cross slide (mm)

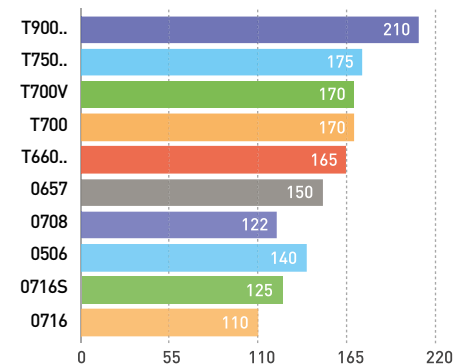

Centers height (mm)

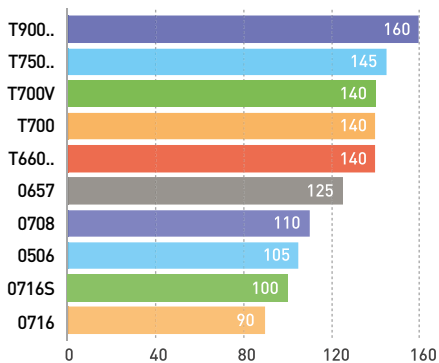

Distance between centers (mm)

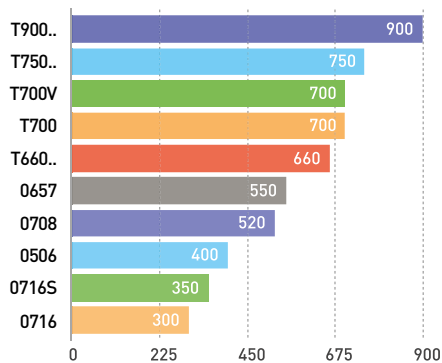

Spindle bore (mm)

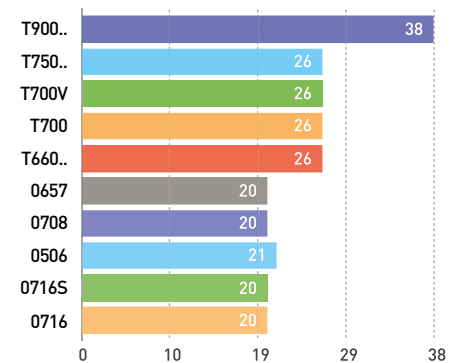

T900I

€ 5840,00

GEAR HEAD LATHE WITH INVERTER

BENCH LATHE SEMI NORTON GEAR BOX AND BELT SPEED, CHANGE, LONGITUDINAL AND CROSS FEEDS, TURNING, LEADSCREW, PARTIALLY ASSEMBLED BENCH WITH 3 DRAWERS, AND CABINET

- 1 Self centering chuck 3+3 Ø 160 mm
- 2 Follow rest
- 3 Steady rest
- 4 Thread dial
- 5 Chuck safeguard
- 6 Leadscrew hood
- 7 Tool post safeguard
- 8 Full length splash guard
- 9 Quick change tool post TOAA
- 10 LED light



Taiwanese inverter with chuck speed adjustment	75 ÷ 500 / 300 ÷ 2000 rpm
Centers height	160 mm
Max swing over the bed	320 mm
Max swing over the cross slide	210 mm
Max length of workpiece	900 mm
Spindle taper MT	5
Spindle bore	38 mm
Longitudinal feeds mm/rev	0,07 ÷ 1,0
Cross feeds mm/rev	0,0017 ÷ 0,25
Metric threads	(18) 0,2 ÷ 3,5 mm
Inch threads	(21) 8 ÷ 56 TPI
Tailstock taper MT	3
Single phase power supply	200-240 V 50 / 60 Hz
Three-phase motor	230 V 1,1 kW
Lathe dimensions	1600 x 750 x 1300 mm
Weight	390 kg



T900

€ 4930,00

GEAR HEAD LATHE

BENCH LATHE SEMI NORTON GEAR BOX AND BELT SPEED, CHANGE, LONGITUDINAL AND CROSS FEEDS, TURNING, LEADSCREW, PARTIALLY ASSEMBLED BENCH WITH 3 DRAWERS, AND CABINET

- 1 Self centering chuck 3+3 Ø 160mm
- 2 Follow rest
- 3 Steady rest
- 4 Thread dial
- 5 Chuck safeguard
- 6 Leadscrew hood
- 7 Tool post safeguard
- 8 Full length splash guard
- 9 Quick change tool post TOAA
- 10 LED light



Centers height	160 mm
Max swing over the bed	320 mm
Max swing over the cross slide	210 mm
Max length of workpiece	900 mm
Spindle taper MT	5
Spindle bore	38 mm
Approx spindle speeds	(6) 125 ÷ 2000 rpm
Longitudinal feeds mm/rev	0,07 ÷ 1,0
Cross feeds mm/rev	0,0017 ÷ 0,25
Metric threads	(18) 0,2 ÷ 3,5 mm
Inch threads	(21) 8 ÷ 56 TPI
Tailstock taper MT	3
Single-phase motor	230 V 50 Hz 1,1 kW
Lathe dimensions	1600 x 750 x 1300 mm
Weight	380 kg



T750I

€ 5290,00

GEAR HEAD LATHE WITH INVERTER

BENCH LATHE SEMI NORTON GEAR BOX AND BELT SPEED, CHANGE, LONGITUDINAL AND CROSS FEEDS, TURNING, LEADSCREW, PARTIALLY ASSEMBLED BENCH WITH 3 DRAWERS, AND CABINET

- 1 Self centering chuck 3+3 Ø 125 mm
- 2 Follow rest
- 3 Steady rest
- 4 Thread dial
- 5 Chuck safeguard
- 6 Leadscrew hood
- 7 Tool post safeguard
- 8 Full length splash guard
- 9 Quick change tool post T0AA
- 10 LED light

Taiwanese inverter with chuck speed adjustment	75 ÷ 500 / 300 ÷ 2000 rpm
Centers height	145 mm
Max swing over the bed	290 mm
Max swing over the cross slide	175 mm
Max length of workpiece	750 mm
Spindle taper MT	4
Spindle bore	26 mm
Longitudinal feeds mm/rev	0,07 ÷ 1,0
Cross feeds mm/rev	0,0017 ÷ 0,25
Metric threads	(18) 0,2 ÷ 3,5 mm
Inch threads	(21) 8 ÷ 56 TPI
Tailstock taper MT	3
Single phase power supply	200-240 V 50 / 60 Hz
Three-phase motor	230 V 1,1 kW
Lathe dimensions	1450 x 720 x 1280 mm
Weight	360 kg

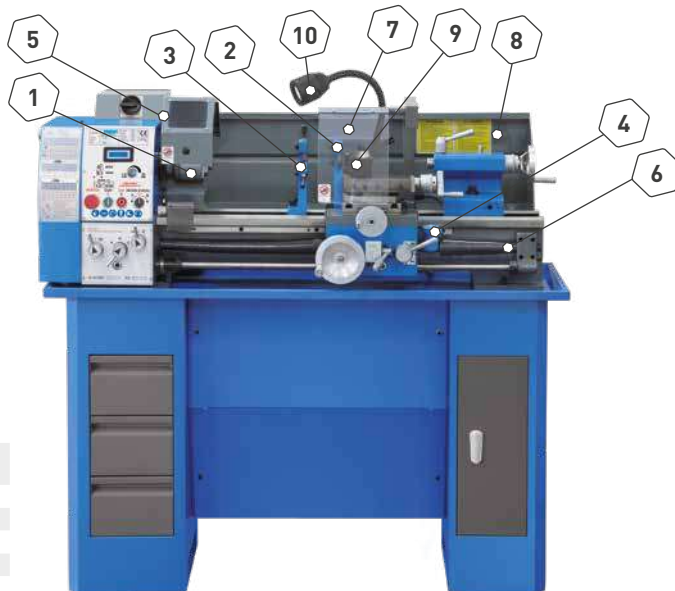
T750

€ 4390,00

GEAR HEAD LATHE

BENCH LATHE SEMI NORTON GEAR BOX AND BELT SPEED, CHANGE, LONGITUDINAL AND CROSS FEEDS, TURNING, LEADSCREW, PARTIALLY ASSEMBLED BENCH WITH 3 DRAWERS, AND CABINET

- 1 Self centering chuck 3+3 Ø 125 mm
- 2 Follow rest
- 3 Steady rest
- 4 Thread dial
- 5 Chuck safeguard
- 6 Leadscrew hood
- 7 Tool post safeguard
- 8 Full length splash guard
- 9 Quick change tool post T0AA
- 10 LED light

Centers height	145 mm
Max swing over the bed	290 mm
Max swing over the cross slide	175 mm
Max length of workpiece	750 mm
Spindle taper MT	4
Spindle bore	26 mm
Approx spindle speeds	(6) 125 ÷ 2000 rpm
Longitudinal feeds mm/rev	0,07 ÷ 1,0
Cross feeds mm/rev	0,0017 ÷ 0,25
Metric threads	(18) 0,2 ÷ 3,5 mm
Inch threads	(21) 8 ÷ 56 TPI
Tailstock taper MT	3
Single-phase motor	230 V 50 Hz 1,1 kW
Lathe dimensions	1450 x 720 x 1280 mm
Weight	350 kg



T700V

€ 4460,00

GEAR HEAD LATHE

BENCH LATHE SEMI NORTON GEAR BOX AND VARIABLE SPEED, LONGITUDINAL AND CROSS FEEDS, TURNING LEADSCREW, PARTIALLY ASSEMBLED BENCH WITH 3 DRAWERS AND CABINET

- 1 Self centering chuck 3+3 Ø 125 mm
- 2 Follow rest
- 3 Steady rest
- 4 Thread dial
- 5 Chuck safeguard
- 6 Leadscrew hood
- 7 Tool post safeguard
- 8 Full length splash guard
- 9 12 mm fix tool post
- 10 Face plate Ø 240 mm
- 11 4 Reversible independent jaws chuck Ø 125 mm

Centers height	140 mm
Max swing over the bed	280 mm
Max swing over the cross slide	170 mm
Max length of workpiece	700 mm
Spindle taper MT	4
Spindle bore	26 mm
Approx spindle speeds	50 ÷ 850 rpm 110 ÷ 1800 rpm
Longitudinal feeds mm/rev	0,07 ÷ 0,65
Cross feeds mm/rev	0,03 ÷ 0,12
Metric threads	0,2 ÷ 3,5 mm
Inch threads	8 ÷ 56 TPI
Tailstock taper MT	2
Single-phase motor	230 V 50 Hz 1,1 kW
Lathe dimensions	1129 x 690 x 1127 mm
Weight	300 kg



T700

€ 3860,00

GEAR HEAD LATHE

BENCH LATHE SEMI NORTON GEAR BOX AND BELT SPEED, CHANGE, LONGITUDINAL AND CROSS FEEDS, TURNING, LEADSCREW, PARTIALLY ASSEMBLED BENCH WITH 3 DRAWERS, AND CABINET

- 1 Self centering chuck 3+3 Ø 125 mm
- 2 Follow rest
- 3 Steady rest
- 4 Thread dial
- 5 Chuck safeguard
- 6 Leadscrew hood
- 7 Tool post safeguard
- 8 Full length splash guard
- 9 12 mm fix tool post
- 10 Face plate Ø 240 mm
- 11 4 Reversible independent jaws chuck Ø 125 mm

Centers height	140 mm
Max swing over the bed	280 mm
Max swing over the cross slide	170 mm
Max length of workpiece	700 mm
Spindle taper MT	4
Spindle bore	26 mm
Approx spindle speeds	(6) 150 ÷ 2000 rpm
Longitudinal feeds mm/rev	0,07 ÷ 0,65
Cross feeds mm/rev	0,03 ÷ 0,12
Metric threads	0,2 ÷ 3,5 mm
Inch threads	8 ÷ 56 TPI
Tailstock taper MT	2
Single-phase motor	230 V 50 Hz 0,85 kW
Lathe dimensions	1129 x 690 x 1127 mm
Weight	300 kg



T660I

€ 4590,00

BENCH LATHE WITH INVERTER

SEMI NORTON GEAR BOX, PARTIALLY ASSEMBLED BENCH

- 1 Self centering chuck 3+3 Ø 125 mm
- 2 Follow rest
- 3 Steady rest
- 4 Thread dial
- 5 Leadscrew hood
- 6 Tool post safeguard
- 7 Chuck safeguard
- 8 Full length splash guard
- 9 TOAA quick change tool post

Japan inverter with chuck speed adjustment	100 ÷ 2000 rpm
Centers height	140 mm
Max swing over the bed	280 mm
Max swing over the cross slide	165 mm
Max length of workpiece	660 mm
Spindle taper MT	4
Spindle bore	26 mm
Longitudinal feeds mm/rev	0,063 ÷ 0,35
Metric threads	0,25 ÷ 3,5 mm
Inch threads	8 ÷ 72 TPI
Tailstock taper MT	2
Three-phase motor	230V 0,75 kW
Single phase power supply	200-240 V 50/60 Hz
Lathe dimensions	1325 x 550 x 1230 mm
Weight	260 kg

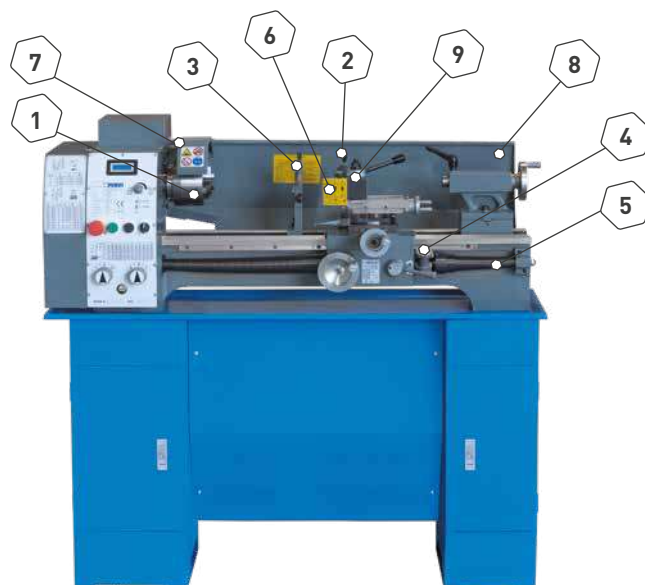
T660

€ 3430,00

BENCH LATHE

SEMI NORTON GEAR BOX AND BELT SPEED CHANGE, PARTIALLY ASSEMBLED BENCH

- 1 Self centering chuck 3+3 Ø 125 mm
- 2 Follow rest
- 3 Steady rest
- 4 Thread dial
- 5 Leadscrew hood
- 6 Full length splash guard
- 7 Tool post safeguard
- 8 Chuck safeguard
- 9 Quick change tool post

Centers height	140 mm
Max swing over the bed	280 mm
Max swing over the cross slide	165 mm
Max length of workpiece	660 mm
Spindle taper MT	4
Spindle bore	26 mm
Approx spindle speeds	(6) 125 ÷ 2000 rpm
Longitudinal feeds mm/rev	0,063 ÷ 0,35
Metric threads	0,25 ÷ 3,5 mm
Inch threads	8 ÷ 72 TPI
Tailstock taper MT	2
Single-phase motor	230 V 50 Hz 0,75 kW
Lathe dimensions	1325 x 550 x 1230 mm
Weight	260 kg

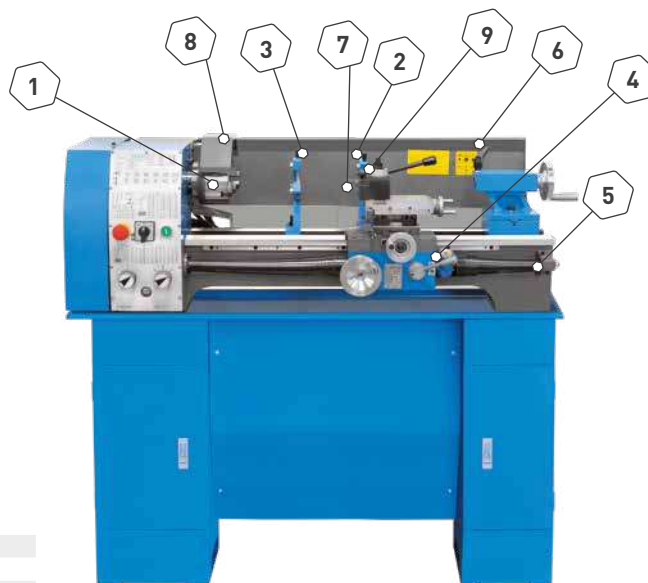

0657

€ 2360,00

BENCH LATHE

WITH MILL TABLE DEVICE, BELT SPEED CHANGE

- 1 Self centering chuck 3+3 Ø 125 mm
- 2 Leadscrew hood
- 3 Tool post safeguard
- 4 Chuck safeguard
- 5 Full length splash guard

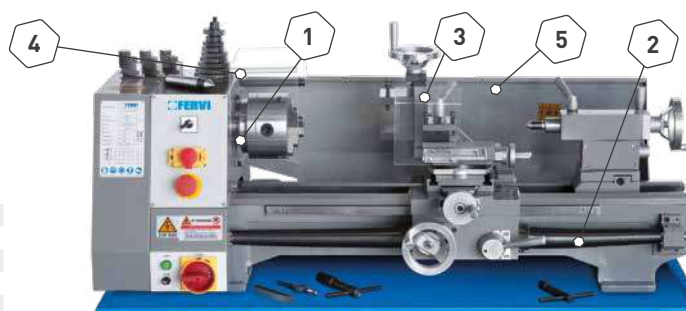

Centers height	125 mm
Distance between centers	550 mm
Max swing over the bed	250 mm
Max swing over the cross slide	150 mm
Chuck 3+3	Ø 125 mm
Spindle taper MT	3
Spindle bore	20 mm
Dead center	CM / MT 2
Metric and inch threads	0,4 ÷ 3,5 mm / 18 ÷ 44 TPI
Longitudinal feeds mm/rev	0,1 / 0,2 mm / giro
Approx spindle speeds	(6) 125 ÷ 2000 rpm
Single-phase motor	220 ÷ 240 V 50 Hz 0,55 kW
Dimensions	1120 x 480 x 460h mm
Packing dimensions	1230 x 730 x 610h mm
Weight	160 kg



0708

€ 1930,00

GEAR BENCH LATHE

WITH SPEED CHANGE BY GEARS, MORSE TAPERED SPINDLE BEARINGS, ADJUSTABLE SIGNS, LEADSCREW HOOD, CHUCK GUARD WITH MICROSWITCH

- 1 Self centering chuck 3+3 Ø 125 mm
- 2 Follow rest
- 3 Thread dial
- 4 Leadscrew hood
- 5 Tool post safeguard
- 6 Chuck safeguard
- 7 Full length splash guard

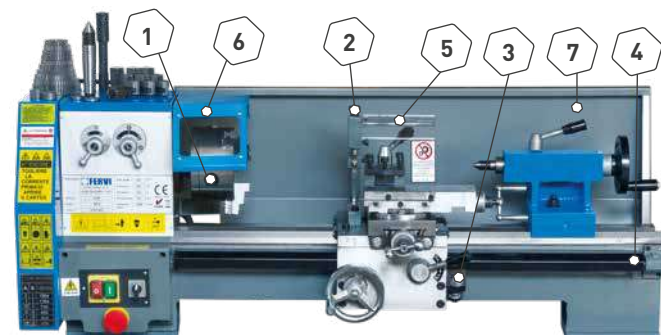

Dimensions w/o base	1080 x 440 x 400h mm
Centers height	110 mm
Distance between centers	520 mm
Max swing over the bed	200 mm
Max swing over the cross slide	122 mm
Chuck 3+3	Ø125 mm
Spindle taper MT	3
Spindle bore	20 mm
Dead center	CM / MT 2
Longitudinal automatic feeds	0,04 - 0,08 - 0,12 - 0,16 - 0,20 mm
Metric and inch threads	0,25 ÷ 3 mm / 8 ÷ 48 TPI
Approx spindle speeds	(6) 170 ÷ 1950 rpm
Single-phase motor	230 V 50 Hz 0,55 kW
Weight	142 kg



0657/B

€ 369,00

BENCH LATHE STAND

NOT ASSEMBLED BENCH LATHE STAND



Dimensions	1050 x 433 x 720h mm
Weight	36,5 kg

0710

€ 270,00

BENCH LATHE STAND

PARTIALLY ASSEMBLED BENCH LATHE STAND



Dimensions	1050 x 320 x 725h mm
Weight	21,5 kg



0506
CAT. 42 € 1750,00
BENCH LATHE

MINI LATHE WITH AUTOMATIC LONGITUDINAL FEEDS AND VARIABLE SPEED SHOWN ON DIGITAL DISPLAY

Centers height	105 mm
Chuck 3+3	100
Spindle taper MT	3
Max length of workpiece	400
Max swing over the bed	210
Max swing over the cross slide	140
Spindle bore	21
Metric threads	(9) 0,5 ÷ 2,5 mm
Inch threads	(18) 12 ÷ 52 TPI
Mechanical speeds	2
Approx spindle speeds	I 50 ÷ 1100 rpm - II 100 ÷ 2500 rpm
Tailstock taper MT	2
Single-phase motor	230 V 50 Hz 0,6 kW
Dimensions	760 x 320 x 350h mm
Net weight	54 kg
Weight	60 kg
Packing dimensions	880 x 380 x 470h mm

0716S
€ 1550,00
MINI LATHE

MINI LATHE WITH AUTOMATIC LONGITUDINAL FEEDS AND VARIABLE SPEED SHOWN ON DIGITAL DISPLAY

Follow rest
Steady rest
Thread dial
Flange ø 125 mm

Centers height	100 mm
Chuck 3+3	ø 100 mm
Spindle taper MT	3
Distance between centers	350 mm
Max swing over the bed	200 mm
Max swing over the cross slide	125 mm
Spindle bore	20 mm
Metric threads	0,5 ÷ 2,5 mm
Mechanical speeds	2
Approx spindle speeds	I 100 ÷ 1100 rpm - II 200 ÷ 2500 rpm
Tailstock taper MT	2
Single-phase motor	230 V 50 Hz 0,6 kW
Overall sizes	750 x 245 x 290h mm
Weight	42 kg

0716
€ 1390,00
MINI LATHE

WITH AUTOMATIC LONGITUDINAL FEEDS AND VARIABLE SPEED SHOWN ON DIGITAL DISPLAY

Follow rest
Steady rest
Thread dial
Flange ø 125 mm

Centers height	90 mm
Chuck 3+3	ø 100 mm
Spindle taper MT	3
Distance between centers	300 mm
Max swing over the bed	180 mm
Max swing over the cross slide	110 mm
Spindle bore	22 mm
Metric threads	0,5 ÷ 2,5 mm
Mechanical speeds	2
Approx spindle speeds	1° 100 ÷ 1100 rpm - 2° 200 ÷ 2500 rpm
Tailstock taper MT	2
Single-phase motor	230 V 50 Hz 0,5 kW
Overall sizes	700 x 230 x 270h mm
Weight	41 kg



0716/B

€ 255,00

BENCH LATHE STAND

BENCH LATHE STAND, LOCKING WITHOUT KEY, INNER SHELF



Dimensions	760 x 240 x 760 mm
Slot distance	475 x 70 mm
Internal shelf height	405 mm
Weight	29 kg

ART.	€	T080F	T075I	T070/400V3A	T070/400V3A15	T070/400V3A	T069/400V3A	T069/400V3A	T069/400V	T998/400V3A	T998/230V3A	T998/400V	T998/230V	T999/230V3A	T998/400V3A	T999/400V3A	T999/230V	T999/400V	T940/230V3A	T940/230V1	T940/230V	T940/400V	T900I	T900	T750I	T750	T700V	T700	T660I	T660	0657	0708	0506	0716S	0716	PAG		
0657/B	369,00																																					23
0710	270,00																																					23
0716/B	255,00																																					25
C046/2	61,00																																					155
C046/3	74,00																																					155
C046/4	78,40																																					155
C046/5	108,00																																					155
C050/2	147,00																																					155
C050/3	165,00																																					155
C050/4	240,00																																					155
C055/3	176,00																																					155
C055/4	249,00																																					155
C055/5	349,00																																					155
ST45/5/4	25,50																																					156
ST45/5/3	25,50																																					156
ST45/4/1	16,00																																					156
ST45/4/2	16,00																																					156
ST45/4/3	16,00																																					156
ST45/3/1	11,60																																					156
ST45/3/2	12,40																																					156
ST45/2/1	9,50																																					156
3/CM2	74,00																																					166
3/CM3	74,00																																					166
3/CM4	83,10																																					166
P032/18P	206,00																																					167
M060/2	374,00																																					161
M060/3	374,00																																					161
M060/4	400,00																																					161
M049/100	160,00																																					158
M049/125	169,00																																					158
M049/160	223,00																																					158
M049/200	308,00																																					158
M049/250	359,00																																					158
M449/100	169,00																																					158
M449/125	195,00																																					158
M449/160	246,00																																					158
M449/200	348,00																																					158
M449/250	450,00																																					158
M449/320	773,00																																					158
FD04/200	165,00																																					157
FD05/200	165,00																																					157
FD05/250	227,00																																					157
FD06/250	232,00																																					157
FD08/250	234,00																																					157
FD08/320	269,00																																					157
0688	167,00																																					170
T00A0	101,00																																					171
T00A1	218,00																																					171
T00A1R	134,00																																					171
T0AA	227,00																																					171
T0AE	288,00																																					171
B007/10	93,60																																					175
B007/12	98,70																																					175
B007/16	122,00																																					175
T201	15,10																																					172
T091	103,00																																					183
T090	141,00																																					183
T089	60,10																																					183



DRILLING MILLING MACHINES



DRILLING MILLING MACHINES



Max drilling capacity (mm)

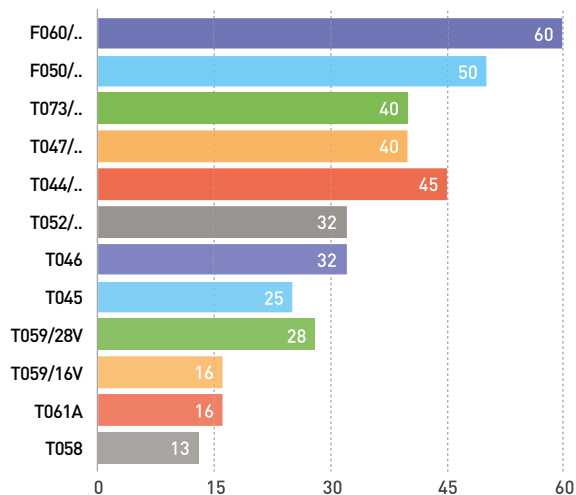

End milling cutter max (mm)

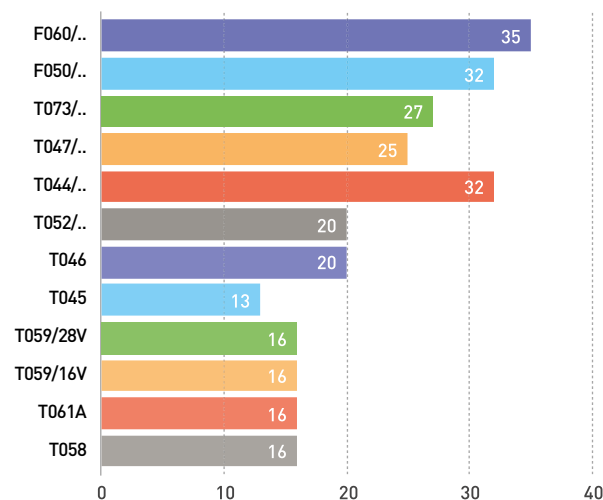

Spindle travel (mm)

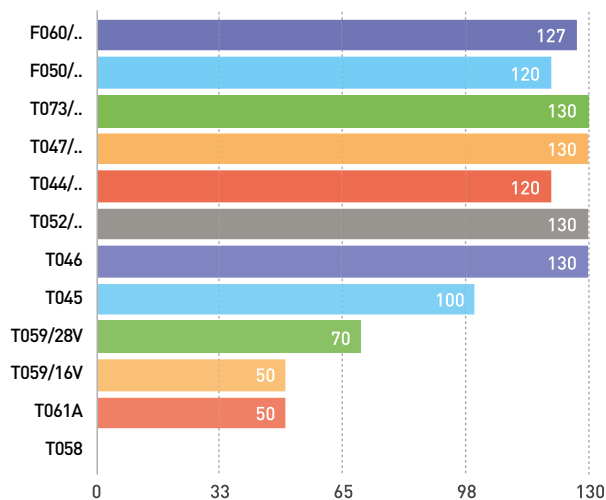

Junction

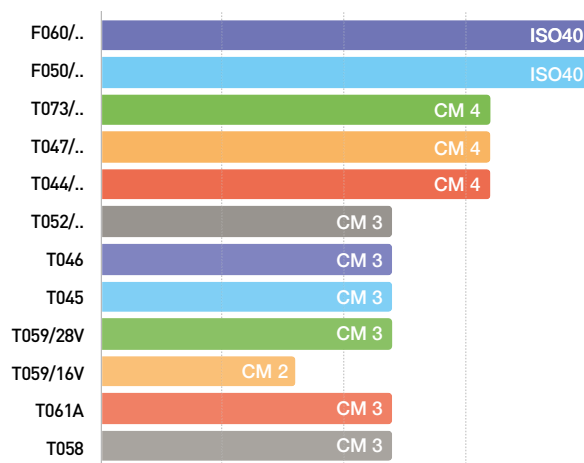
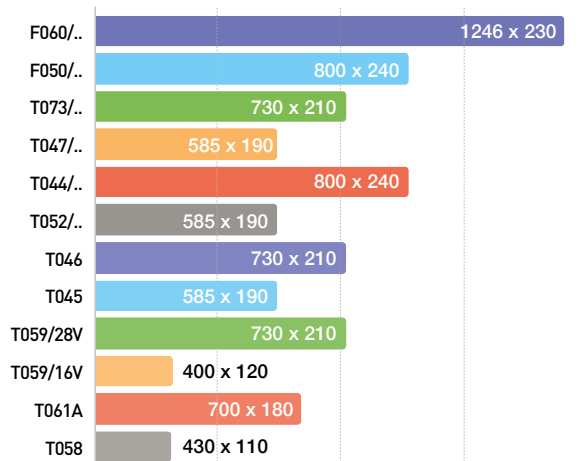
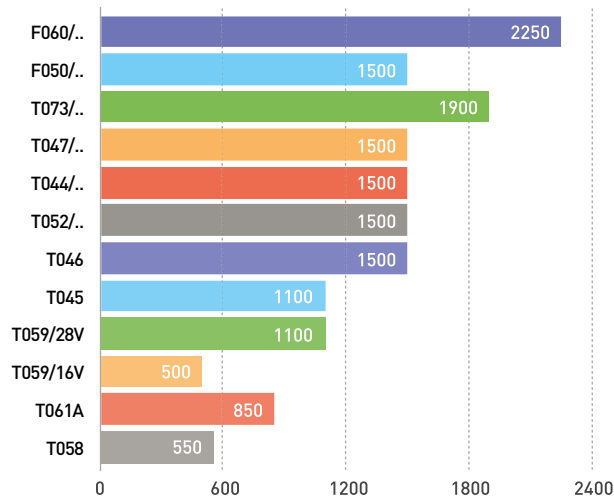

Table dimensions (mm)



Power (W)



F0601
CAT. 42 € 19000,00
INVERTER VERTICAL MILLING MACHINE

ISO40, MOTORIZED CROSS TABLE, 3 AXIS READ OUT AND JAPANESE INVERTER

- 1 **Induction motor with fan**
- 2 **Working light**
- 3 **Table motorization - longitudinal axis**
- 4 **Table motorization - transverse axis**
- 5 **Table motorization - vertical axis**
- 6 **Cooling system**
- 7 **3 Axis read out**
- 8 **Speed knob**

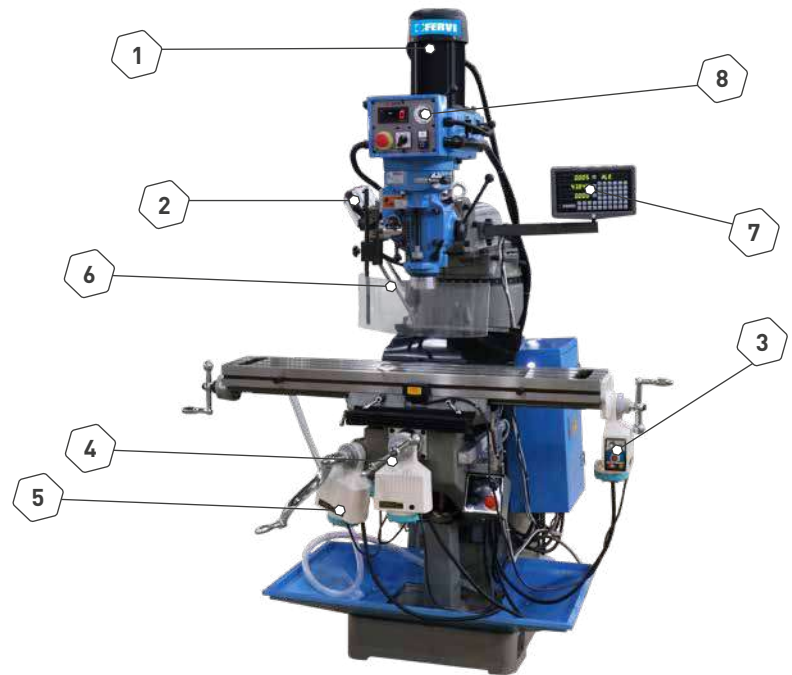
INCLUDED ACCESSORIES

Lubrication system with manual pump
 Base with chip tray
 LED Lamp
 Coolant system
 3 Axis DRO

Japan inverter with chuck speed adjustment	60 ÷ 4200 rpm
Max drilling capacity on cast iron with pre-drilling hole	60 mm
Face milling cutter max	100 mm
End milling capacity	35 mm
Spindle nose Camlock	ISO 40 - DIN 2080
Spindle travel	127 mm
Head tilt left and right	± 45°
Vertical head rotation	± 90°
Three-phase motor	400 V 50 Hz 2.25 kW
Table dimensions	1246 x 230 mm
Longitudinal axis	850 mm
Cross axis	310 mm
Slot	16 mm
Net weight	1000 kg
Weight	1280 kg
Packing dimensions	1500 x 1600 x 2130h mm



F060V

CAT. 42 € 16580,00

VERTICAL MILLING MACHINE

VARIABLE SPEED, ISO40, MOTORIZED CROSS TABLE, 3 AXIS READ OUT



- 1 Motor
- 2 Working light
- 3 Table motorization - longitudinal axis
- 4 Table motorization - transverse axis
- 5 Table motorization - vertical axis
- 6 Cooling system
- 7 3 Axis read out

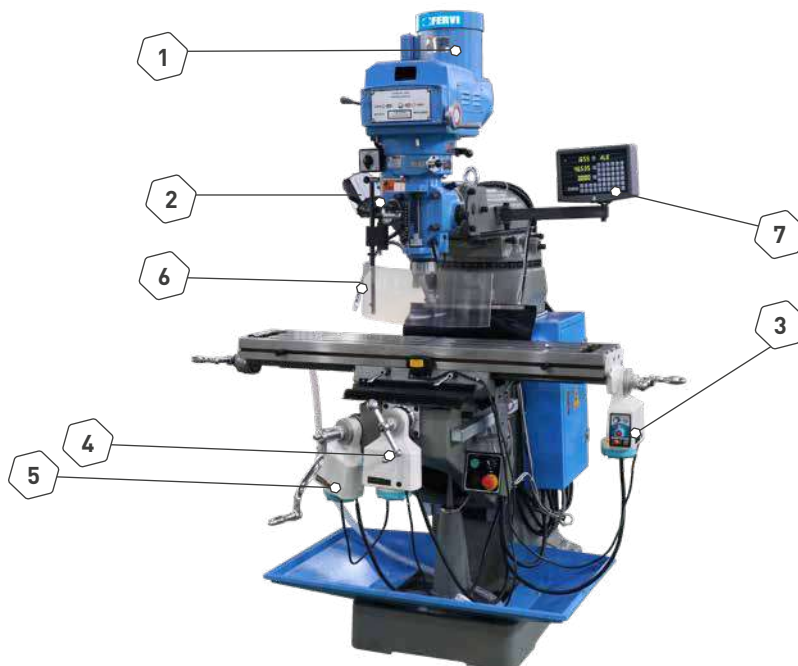

INCLUDED ACCESSORIES

Lubrication system with manual pump
 Base with chip tray
 LED Lamp
 Coolant system
 3 Axis DRO

Max drilling capacity on cast iron with pre-drilling hole	60 mm
Face milling cutter max	100 mm
End milling capacity	35 mm
Spindle taper	ISO40 DIN2080
Spindle travel	127 mm
Head tilt left and right	± 45°
Vertical head rotation	± 90°
Vertical spindle speeds	60 - 4200 rpm
Three-phase motor	400 V 50 Hz 2.25 kW
Table dimensions	1246 x 230 mm
Longitudinal axis	850 mm
Cross axis	310 mm
Slot	16 mm
Net weight	1000 kg
Weight	1280 kg
Packing dimensions	1600 x 1500 x 2130 mm



F060

CAT. 42 € 15000,00

VERTICAL MILLING MACHINE

ISO40, MOTORIZED CROSS TABLE, 3 AXIS READ OUT

- 1 **Motor**
- 2 **Working light**
- 3 **Table motorization - longitudinal axis**
- 4 **Table motorization - transverse axis**
- 5 **Table motorization - vertical axis**
- 6 **Cooling system**
- 7 **3 Axis read out**

INCLUDED ACCESSORIES

- Base with chip tray
- Lubrication system with manual pump
- LED Lamp
- Coolant system
- 3 Axis DRO

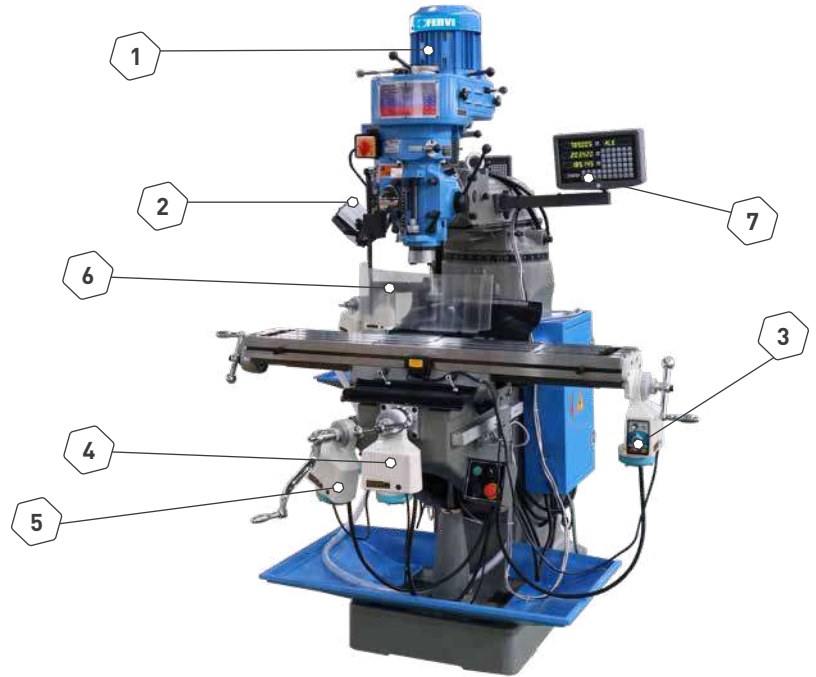

Max drilling capacity on cast iron with pre-drilling hole	60 mm
Face milling cutter max	100 mm
End milling cutter max	35 mm
Spindle taper	ISO40 DIN2080
Spindle travel	127 mm
Head tilt left and right	±45°
Vertical head rotation	±90°
Vertical spindle speeds	60 ÷ 4200 rpm
Three-phase motor	400 V 50 Hz 2,25 kW
Table dimensions	1246 x 230 mm
Longitudinal axis	850 mm
Cross axis	310 mm
Slot	16 mm
Net weight	1000 kg
Weight	1280 kg
Packing dimensions	1500 x 1600 x 2130h mm



F050U

€ 10300,00

UNIVERSAL MILLING MACHINE

VERTICAL AND HORIZONTAL MILLING MACHINE, ISO40, MOTORIZED ONE AXIS CROSS TABLE, 3 AXIS READ OUT

- 1 **Induction motor**
- 2 **Horizontal milling**
- 3 **3 Axis read out**

Max drilling capacity on cast iron with pre-drilling hole	Ø 50 mm
Face milling cutter max	Ø 100 mm
End milling cutter max	Ø 32 mm
Spindle taper	ISO40 DIN2080
Spindle travel	120 mm
Head tilt left and right	± 90°
Vertical head rotation	± 180°
Vertical spindle speeds	(8) 115 ÷ 1750 rpm
Horizontal spindle speeds	(9) 60 ÷ 1350 rpm
Three-phase motor	400 V 50 Hz 0,85 - 1,5 kW
Horizontal three phase motor	400 V 50 Hz 1,5 kW
Table dimensions	800 x 240 mm
Longitudinal axis	380 mm
Cross axis	220 mm
Slot	14 mm
Weight	930 kg
Packing dimensions	1340 x 1150 x 2100 mm

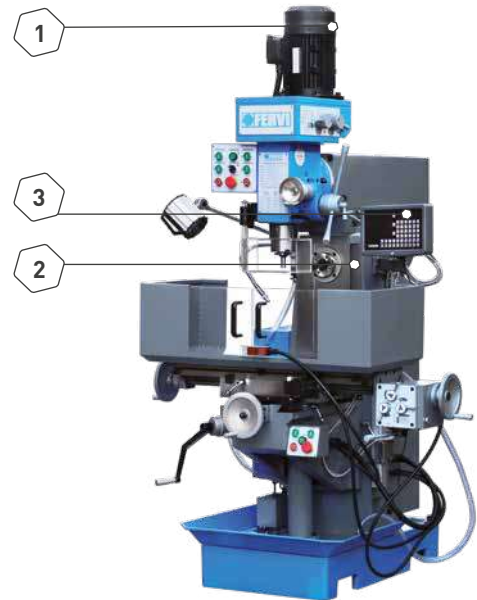
**F050I**

€ 11330,00

INVERTER MILLING MACHINE

JAPANESE INVERTER, VERTICAL MILLING MACHINE, ISO40, MOTORIZED ONE AXIS CROSS TABLE, 3 AXIS READ OUT

- 1 **Induction motor with fan**
- 2 **Working light**
- 3 **Cross table gearbox**

Japan inverter with chuck speed adjustment	100 ÷ 2000 rpm
Max drilling capacity on cast iron with pre-drilling hole	Ø 50 mm
Face milling cutter max	Ø 100 mm
End milling cutter max	Ø 32 mm
Spindle taper	ISO40 DIN2080
Spindle travel	120 mm
Head tilt left and right	± 90°
Vertical head rotation	± 180°
Three-phase motor	400 V 50 Hz 2,2 kW
Table dimensions	800 x 240 mm
Longitudinal axis	380 mm
Cross axis	220 mm
Slot	14 mm
Weight	930 kg
Packing dimensions	1340 x 1150 x 2100 mm

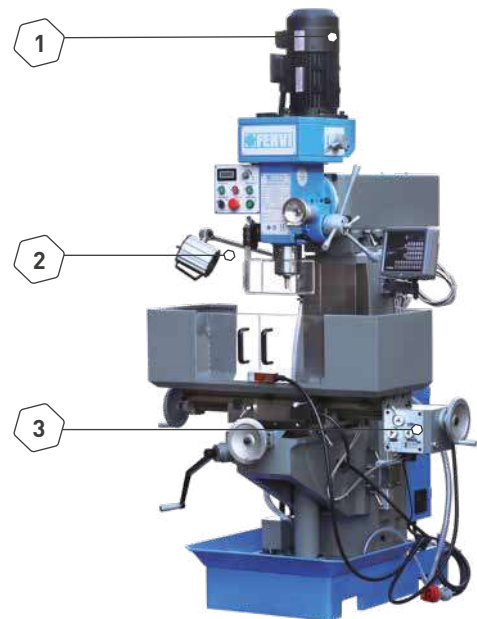

F050

€ 9440,00

MILLING MACHINE

VERTICAL MILLING MACHINE, ISO40, MOTORIZED ONE AXIS CROSS TABLE, 3 AXIS READ OUT

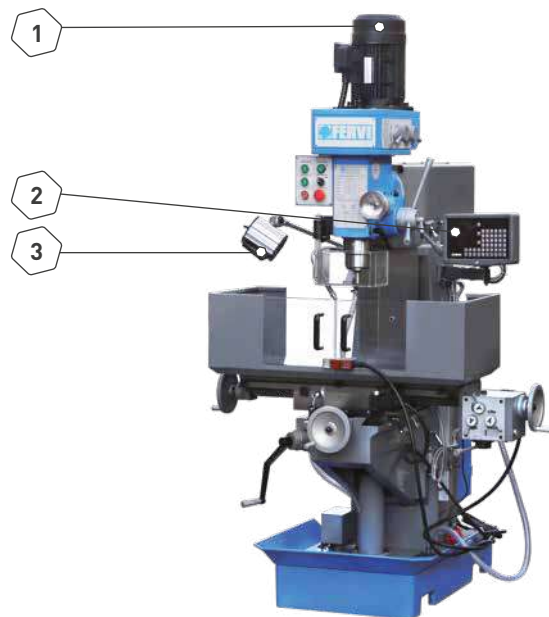

- 1 **Induction motor with fan**
- 2 **3 Axis read out**
- 3 **Working light**

Max drilling capacity on cast iron with pre-drilling hole	Ø 50 mm
Face milling cutter max	Ø 100 mm
End milling cutter max	Ø 32 mm
Spindle taper	ISO40 DIN2080
Spindle travel	120 mm
Head tilt left and right	± 90°
Vertical head rotation	± 180°
Vertical spindle speeds	(8) 115 ÷ 1750 rpm
Three-phase motor	400 V 50 Hz 0,85 - 1,5 kW
Table dimensions	800 x 240 mm
Longitudinal axis	380 mm
Cross axis	220 mm
Slot	14 mm
Weight	930 kg
Packing dimensions	1340 x 1150 x 2100 mm

T073

€ 6250,00

FLOOR DRILLING MILLING MACHINE

WITH BELT DRIVE, REVERSIBLE, COOLING SYSTEM,

ACCESSORIES INCLUDED

Drill chuck with key 1 ÷ 13 mm B16
 DRILL CHUCK SHANK MT 4 B16
 Spindle taper shank MT 4 Ø 27 mm
 Reduction sleeve MT 4/3 and MT 3/2

Max drilling capacity on cast iron with pre-drilling hole	40 mm
Max drilling capacity on steel with pre-drilling hole(s)235jr]	32 mm
Face milling cutter max	80 mm
End milling cutter max	25 mm
Spindle taper MT	4
Distance between chuck and column	300 mm
Max distance spindle nose - table	50 ÷ 700 mm
Spindle travel	130 mm
Manual vertical feed division	0,05 mm
Quill	75 mm
Column	123 mm
Table dimensions	730 x 210 mm
Slot	14 mm
Longitudinal travel	480 mm
Cross travel	220 mm
Approx spindle speeds	100 ÷ 2200 rpm
3 phases 2 speed motor	400 V 50 Hz 1,1/1,9 kW
Net weight	410 kg
Overall dimensions	850 x 1100 x 1900h mm
Weight	470 kg
Packing dimensions	610 x 1140 x 2050h mm



T073DA

€ 7670,00

FLOOR DRILLING MILLING MACHINE

WITH BELT DRIVE, DOWN SPEED, REVERSIBLE, COOLING SYSTEM

ACCESSORIES INCLUDED

Drill chuck with key 1 ÷ 13 mm B16

DRILL CHUCK SHANK MT 4 B16

Spindle taper shank MT 4 Ø 27 mm

Reduction sleeve MT 4/3 and MT 3/2

Max drilling capacity on cast iron with pre-drilling hole	40 mm
Max drilling capacity on steel with pre-drilling hole(s)235jr	32 mm
Face milling cutter max	80 mm
End milling cutter max	25 mm
Spindle taper MT	4
Distance between chuck and column	300 mm
Max distance spindle nose - table	50 ÷ 700 mm
Spindle travel	130 mm
Manual vertical feed division	0,05 mm
Quill	75 mm
Column	123 mm
Table dimensions	730 x 210 mm
Slot	14 mm
Longitudinal travel	480 mm
Cross travel	220 mm
Approx spindle speeds	100 - 2200 rpm
Feed range	(3) 0,05 - 0,1 - 0,2 mm/rev
Three-phase motor	400 V 50 Hz 1,1 / 1,9 kW
Net weight	420 kg
Overall dimensions	850 x 1100 x 1900h mm
Weight	480 kg
Packing dimensions	610 x 1140 x 2050h mm

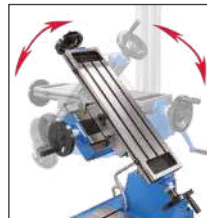
**T047/400VDA**

€ 4080,00

GEARED MILLING DRILLING MACHINE

REVERSIBLE GEARED MILLING DRILLING MACHINE, WITH AUTOMATIC DOWN FEED, COOLANT SYSTEM AND REVERSE ROTATION

- 1 Induction motor
- 2 Tilting head
- 3 Chuck safeguard

Max drilling capacity on cast iron with pre-drilling hole	Ø 40 mm
Drilling capacity:Steel C60	Ø 32 mm
Face milling cutter max	Ø 80 mm
End milling cutter max	Ø 25 mm
Tapping capacity	Ø 22 mm
Spindle taper MT	4
Spindle travel	130 mm
Quill	Ø 76 mm
Distance between chuck and column	260 mm
Column	Ø 115 mm
Head tilt left and right	± 60°
Approx spindle speeds	(12) 75 ÷ 3200 rpm
Feed range	(3) 0,1 - 0,18 - 0,26 mm/g
Three-phase motor	400 V 50 Hz 1,1 - 1,5 kW
Slot	12 mm
Table dimensions	585 x 190 mm
Base dimensions	648 x 412 mm
Overall sizes	740 x 790 x 1960h mm
Weight	390 kg

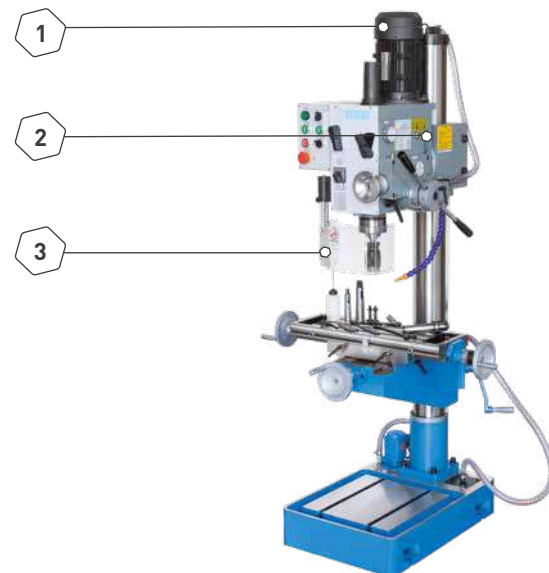

T047/230V & T047/400V
€ 3820,00
GEARED MILLING DRILLING MACHINE

REVERSIBLE WITH COOLANT SYSTEM AND TEMPORISED TAPPING

- 1 **Induction motor**
- 2 **Tilting head**
- 3 **Chuck safeguard**

Max drilling capacity on cast iron with pre-drilling hole	Ø 40 mm
Drilling capacity: Steel C60	Ø 32 mm
Face milling cutter max	Ø 80 mm
End milling cutter max	Ø 25 mm
Tapping capacity	Ø 22 mm
Spindle taper MT	4
Spindle travel	130 mm
Quill	Ø 76 mm
Distance between chuck and column	260 mm
Column	Ø 115 mm
Head tilt left and right	± 60°
Approx spindle speeds	{6} 75 - 1600 rpm
Motor	230 V 50 Hz 1,5 kW 400 V 50 Hz 1,1 - 1,5 kW
Table dimensions	585 x 190 mm
Slot	12 mm
Base dimensions	648 x 412 mm
Overall sizes	740 x 790 x 1960h mm
Weight	390 kg

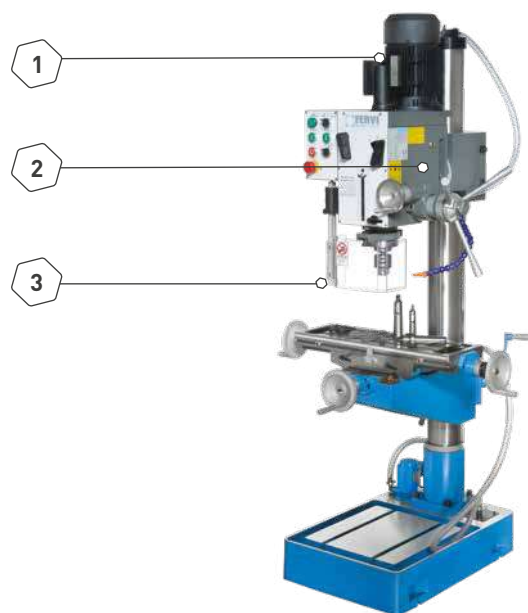
T044/230V & T044/400V
€ 3650,00
GEARED DRILLING MILLING MACHINE

REVERSIBLE, WITH SQUARE COLUMN, DOVETAIL GUIDES AND CHUCK ROTATION DX AND SX

- 1 **Induction motor**
- 2 **Gearbox lever**
- 3 **Graduated scale depth**
- 4 **Chuck safeguard**

Max drilling capacity on steel with pre-drilling hole(s235jr)	Ø 45 mm
Face milling cutter max	Ø 80 mm
End milling cutter max	Ø 32 mm
Head tilt left and right	± 60°
Spindle taper MT	4
Distance between chuck and column	240 mm
Max distance spindle nose - table	460 mm
Spindle travel	120 mm
Manual vertical feed division	0,02 mm
Quill	Ø 75 mm
Table dimensions	800 x 240 mm
Slot	14 mm
Longitudinal travel	560 mm
Cross travel	190 mm
Approx spindle speeds	95 - 170 - 280 - 540 - 960 - 1600 rpm
Motor	230 V 50 Hz 1,5 kW 400 V 50 Hz 1,5 kW
Base dimensions	405 x 630 mm
Weight	350 kg
Packing dimensions	1090 x 785 x 1120 mm

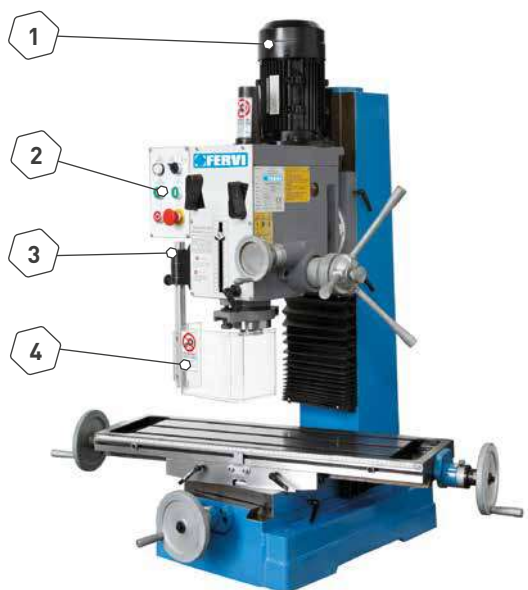

T059/28V

€ 3260,00

GEARED DRILLING MILLING MACHINE EQUIPPED

VARIABLE SPEED, WITH LIGHT

- 1** Induction motor
- 2** Head with adjustable height
- 3** Chuck safeguard
- 4** Head lifting dial
- 5** Cross feed table
- 6** Speed display

Max drilling capacity	Ø 28 mm
End milling capacity	Ø 16 mm
Face milling capacity	Ø 63 mm
Spindle stroke	70 mm
Headstock travel	380 mm
Head tilt left and right	±90°
Spindle taper MT	3
Slot	14 mm
Longitudinal axis	190 mm
Cross axis	440 mm
Approx spindle speeds	100 ÷ 2500 rpm ±10%
Spindle rotation	L - R
Table dimensions	730 x 210 mm
Single-phase motor	230 V 50 Hz 1,1 kW
Weight	290 kg
Packing dimensions	940 x 970 x 1100 mm

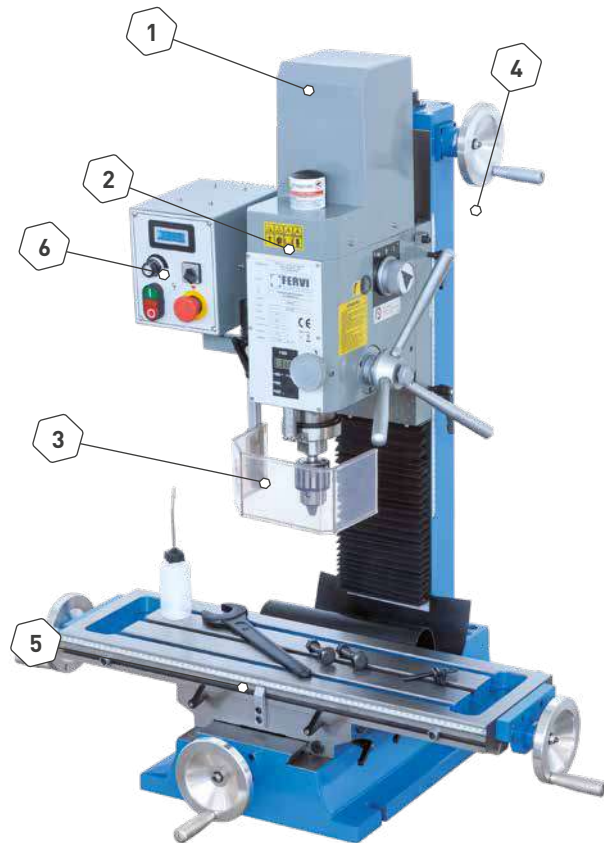
**T061A**

CAT. 42 € 2530,00

GEARED DRILLING MILLING MACHINE

VARIABLE SPEED, EQUIPPED WITH LIGHT SYSTEM, CHUCK SPEED DIGITAL DISPLAY, DEPTH'S DIGITAL DISPLAY

Max drilling capacity	Ø 16 mm
End milling capacity	Ø 20 mm
Face milling capacity	Ø 63 mm
Spindle stroke	50 mm
Headstock travel	290 mm
Distance between spindle nose and table	350 mm
Head tilt left and right	±90°
Spindle taper MT	3
Slot	12 mm
Longitudinal axis	175 mm
Cross axis	490 mm
Spindle speed	1° 30 ÷ 1650 rpm ±10% -- 2° 40 ÷ 2850 rpm ±10%
Spindle rotation	Dx - Sx / L - R
Table dimensions	700 x 180 mm
Single-phase motor	230 V 50 Hz 1,1 kW
Net weight	115 kg
Gross weight	145 kg
Packing dimensions	720 x 760 x 930 mm



T059/16V

€ 1700,00

GEARED DRILLING MILLING MACHINE EQUIPPED

VARIABLE SPEED, WITH LIGHT

- 1 Induction motor
- 2 Head with adjustable height
- 3 Chuck safeguard
- 4 Head lifting dial
- 5 Cross feed table

Max drilling capacity	Ø 16 mm
End milling capacity	Ø 16 mm
Face milling capacity	Ø 50 mm
Spindle stroke	50 mm
Headstock travel	210 mm
Head tilt left and right	±90°
Spindle taper MT	2
Slot	10 mm
Longitudinal axis	160 mm
Cross axis	220 mm
Approx spindle speeds	1° 100 ÷ 1500 rpm ±10% -- 2° 200 ÷ 3000 rpm ±10%
Spindle rotation	L - R
Table dimensions	400 x 120 mm
Single-phase motor	230 V 50 Hz 500 W
Weight	78 kg
Packing dimensions	485 x 445 x 860 mm

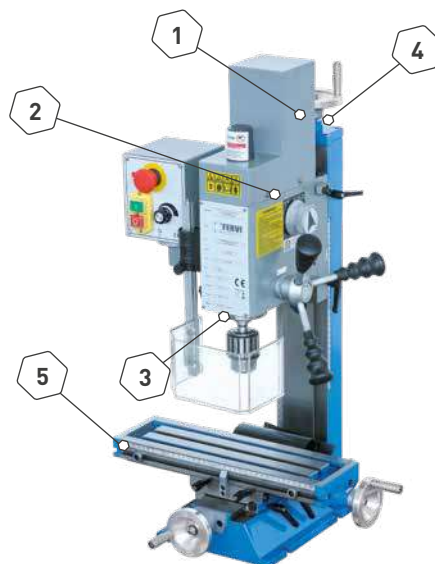

T058

€ 1370,00

GEARED DRILLING MILLING MACHINE

- 1 Induction motor
- 2 Head with adjustable height
- 3 Chuck safeguard
- 4 Cross feed table

Max drilling capacity	Ø 13 mm
End milling capacity	Ø 16 mm
Face milling capacity	Ø 30 mm
Headstock travel	210 mm
Spindle rotary angle	±45°
Spindle taper MT	3
Slot	12 mm
Distance between spindle nose and table	290 mm
Longitudinal axis	130 mm
Cross axis	250 mm
Approx spindle speeds	1° 50 ÷ 1100 rpm ±10% - 2° 120 ÷ 2500 rpm ±10%
Table dimensions	430 x 110 mm
Single-phase motor	230 V 50 Hz 0,55 kW
Weight	74 kg
Packing dimensions	660 x 550 x 720 mm

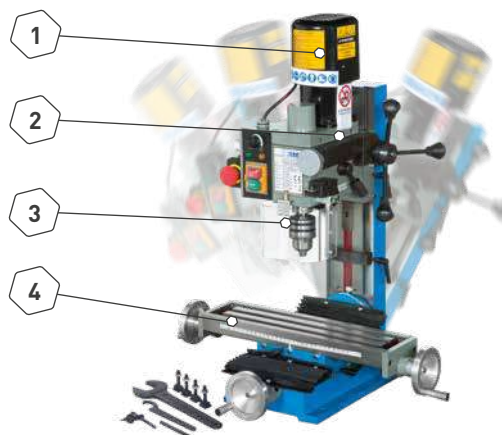

0599

€ 309,00

UNIVERSAL BENCH FOR DRILLING MILLING MACHINES

WITH TOOL COMPARTMENT AND LOCK

Base dimensions	415 x 625 x 750h mm
Chip pan dimensions	615 x 820 x 30h mm
Bottom Chip pan dimensions	530 x 735 mm
Weight	59 kg



T052/400VDA

€ 3690,00

FLOOR DRILLING MILLING MACHINE

WITH DOWN FEED, ROTATION SELECTION AND DRIVE BELT

ACCESSORIES INCLUDED

Drill chuck with key 1 ÷ 13 B16
Spindle drilled MT 3
Spindle taper shank MT 3 Ø 27 mm
Coolant system

Max drilling capacity	Ø 32 mm
Face milling cutter max	Ø 80 mm
End milling cutter max	Ø 20 mm
Headstock travel	405 mm
Spindle taper MT	3
Distance between chuck and column	205 mm
Max distance spindle nose - table	700 mm
Spindle travel	130 mm
Manual vertical feed division	0,05 mm
Quill	Ø 75 mm
Column	Ø 115 mm
Table dimensions	585 x 190 mm
Slot	12 mm
Longitudinal travel	180 mm
Cross travel	380 mm
Approx spindle speeds	125 ÷ 2500 rpm
Feed range	0,12 – 0,18 – 0,25 mm/g
Three-phase motor	400 V 50 Hz 1,5 kW
Weight	325 kg
Packing dimensions	830 x 740 x 1860 mm



T052/400V

€ 3180,00

FLOOR DRILLING MILLING MACHINE

WITH ROTATION SELECTION AND DRIVE BELT

- 1 Micrometric feed
- 2 Table lifting wheel
- 3 Chuck safeguard
- 4 Table
- 5 Coolant pump

Max drilling capacity	Ø 32 mm
Face milling cutter max	Ø 80 mm
End milling cutter max	Ø 20 mm
Headstock travel	405 mm
Spindle taper MT	3
Distance between chuck and column	205 mm
Max distance spindle nose - table	700 mm
Spindle travel	130 mm
Manual vertical feed division	0,05 mm
Quill	Ø 75 mm
Column	Ø 115 mm
Table dimensions	585 x 190 mm
Slot	12 mm
Longitudinal travel	180 mm
Cross travel	380 mm
Approx spindle speeds	125 ÷ 2500 rpm
Three-phase motor	400 V 50 Hz 1,5 kW
Weight	310 kg
Packing dimensions	830 x 740 x 1860 mm

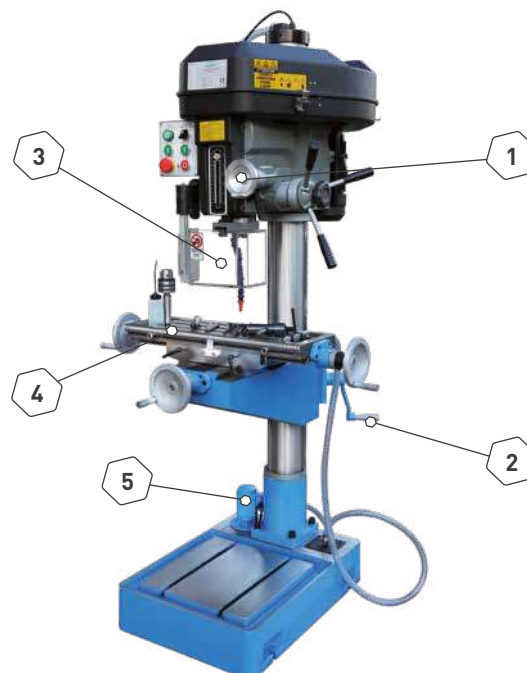

T046

€ 2750,00

DRILLING MILLING MACHINE

WITH ROTATION SELECTION AND DRIVE BELT

- 1 Adjustable head
- 2 Chuck safeguard
- 3 Table



Max drilling capacity	Ø 32 mm
Face milling cutter max	Ø 80 mm
End milling cutter max	Ø 20 mm
Headstock travel	405 mm
Spindle taper MT	3
Distance between chuck and column	200 mm
Max distance spindle nose - table	457 mm
Spindle travel	130 mm
Manual vertical feed division	0,05 mm
Quill	Ø 75 mm
Column	Ø 115 mm
Table dimensions	730 x 210 mm
Slot	14 mm
Longitudinal travel	175 mm
Cross travel	500 mm
Approx spindle speeds	100 ÷ 2080 rpm
Single-phase motor	230 V 50 Hz 1,5 kW
Weight	290 kg
Packing dimensions	870 x 760 x 1150 mm

T045

€ 2230,00

DRILLING MILLING MACHINE

WITH ROTATION SELECTION AND DRIVE BELT

- 1 Adjustable head
- 2 Chuck safeguard
- 3 Table

Max drilling capacity	Ø 25 mm
Face milling cutter max	Ø 63 mm
End milling cutter max	Ø 13 mm
Headstock travel	400 mm
Spindle taper MT	3
Quill	Ø 62 mm
Column	Ø 92 mm
Table dimensions	585 x 190 mm
Slot	14 mm
Longitudinal travel	160 mm
Cross travel	370 mm
Approx spindle speeds	90 ÷ 2150 rpm
Single-phase motor	230 V 50 Hz 1,1 kW
Distance between chuck and column	200 mm
Max distance spindle nose - table	380 mm
Spindle travel	100 mm
Manual vertical feed division	0,03 mm
Packing dimensions	730 x 670 x 1020 mm
Weight	200 kg

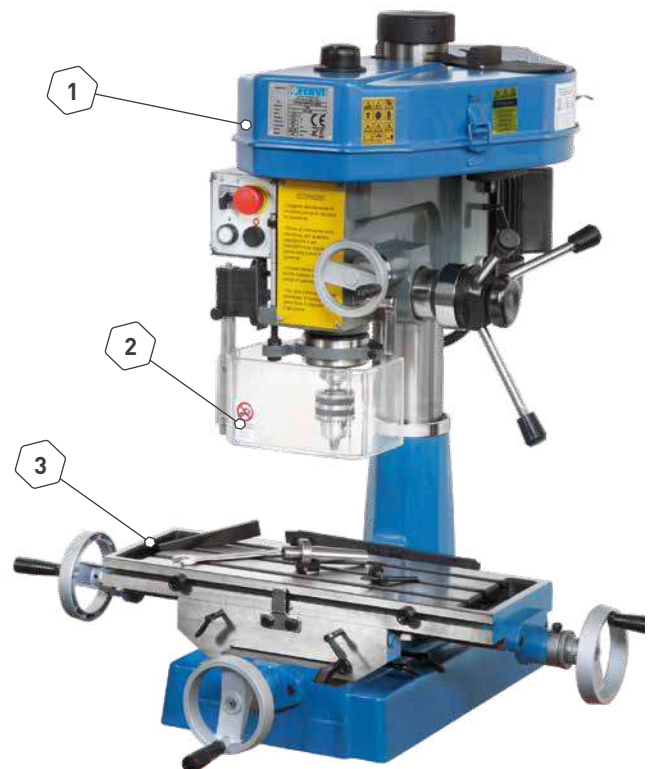

COMPATIBILITY CHART



Art.	€	F060I	F060V	F060	F050U	F050I	F050	T073	T073DA	T047/400VDA	T047/230V	T047/400V	T044/230V	T044/400V	T046	T045	T058	T061A	T059/28V	T059/16V	T052/400VDA	T052/400V	PAG	
M001/100	50,00														•	•	•	•					145	
M001/120	61,40														•	•	•	•					145	
M001/150	77,00														•	•	•	•					145	
M027/100	133,00														•	•	•	•					145	
M027/140	187,00	•	•	•	•	•	•	•	•	•	•	•	•	•									145	
M027/200	303,00	•	•	•	•	•	•	•	•	•	•	•	•	•									145	
K001/12	92,70									•	•	•					•	•				•	154	
K001/14	103,00				•	•	•	•	•				•	•	•	•			•				154	
K001/16	120,00	•	•	•																			154	
K002/12	29,20									•	•	•					•	•					154	
K002/14	34,30				•	•	•	•	•				•	•	•	•			•			•	154	
ST45/3/1	11,60														•	•	•	•				•	156	
ST45/3/2	12,40														•	•	•	•				•	156	
ST45/4/1	16,00							•	•	•	•	•	•	•									156	
ST45/4/2	16,00							•	•	•	•	•	•	•									156	
ST45/4/3	16,00							•	•	•	•	•	•	•									156	
2-XB	-	•	•	•	•	•	•																165	
4-XB	-	•	•	•	•	•	•																165	
3/CM3	74,00														•	•	•	•	•		•	•	166	
3/CM4	83,10							•	•	•	•	•	•	•									166	
P032/18P	206,00	•	•	•	•	•	•	•	•	•	•	•	•	•	•	•	•	•	•		•	•	167	
16/CM3	78,40														•	•	•	•	•		•	•	165	
16/CM4	78,40							•	•	•	•	•	•	•									165	
22/CM4	78,40							•	•														165	
27/CM4	78,40							•	•														165	
3/B/40	86,30	•	•	•	•	•	•																166	
M059/07	405,00														•	•			•	•	•	•	161	
M059/12	464,00														•	•			•		•	•	161	
M059/20	568,00																						161	
M060/3	374,00														•	•			•		•	•	161	
M060/4	400,00							•	•	•	•	•	•	•							•	•	161	
M004/3	149,00														•	•	•	•			•	•	161	
P018/230V	282,00												•		•	•			•	•	•		172	
P018/400V	282,00													•								•	•	172
0599	309,00												•	•	•	•	•	•	•	•			36	
T201	15,10	•	•	•	•	•	•	•	•	•	•	•	•	•									172	
0532A/230V	163,00	•	•	•	•	•	•	•	•	•	•	•	•	•	•	•						•	•	174
S001	78,40	•	•	•	•	•	•	•	•	•	•	•	•	•	•	•	•	•	•	•	•	•	•	238
L020	83,10	•	•	•	•	•	•	•	•	•	•	•	•	•	•	•	•	•	•	•	•	•	•	234
F430	62,70	•	•	•	•	•	•	•	•	•	•	•	•	•	•	•	•	•	•	•	•	•	•	237
P046	26,40	•	•	•	•	•	•	•	•	•	•	•	•	•	•	•	•	•	•	•	•	•	•	209
P058/170	149,00	•	•	•	•	•	•	•	•	•	•	•	•	•	•	•	•	•	•	•	•	•	•	210
P010/41	120,00	•	•	•	•	•	•	•	•	•	•	•	•	•	•	•	•	•	•	•	•	•	•	210
P057	86,30							•	•	•	•	•	•	•	•	•	•	•			•	•	218	
0238	9,80							•	•	•	•	•	•	•	•	•	•	•	•			•	•	231
0712/009	83,10	•	•	•	•	•	•	•	•	•	•	•	•	•	•	•	•	•	•	•		•	•	224
F001/10	192,00	•	•	•	•	•	•	•	•	•	•	•	•	•	•	•			•	•	•	•	•	235
F001/20	192,00	•	•	•	•	•	•	•	•	•	•	•	•	•	•	•								235
F002/6	238,00	•	•	•	•	•	•	•	•	•	•	•	•	•	•	•						•	•	221
F011/6	156,00							•	•	•	•	•	•	•	•	•				•				219
M038	542,00									•	•	•	•	•	•	•						•	•	172

FLOOR DRILLING MACHINES

114

TR01/200



TR01/180



T145



T066



T062



T041/..



T032DA



T032



T072



T072DA



T071



0252/..



0512



0754/..



FLOOR DRILLING MACHINES



CM

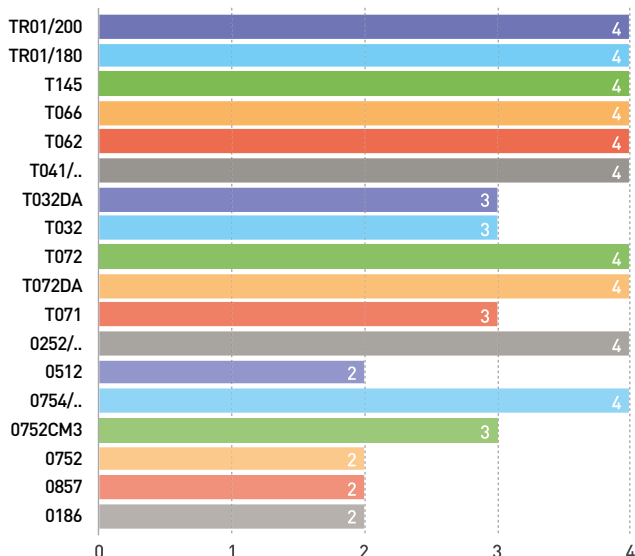

Spindle travel (mm)

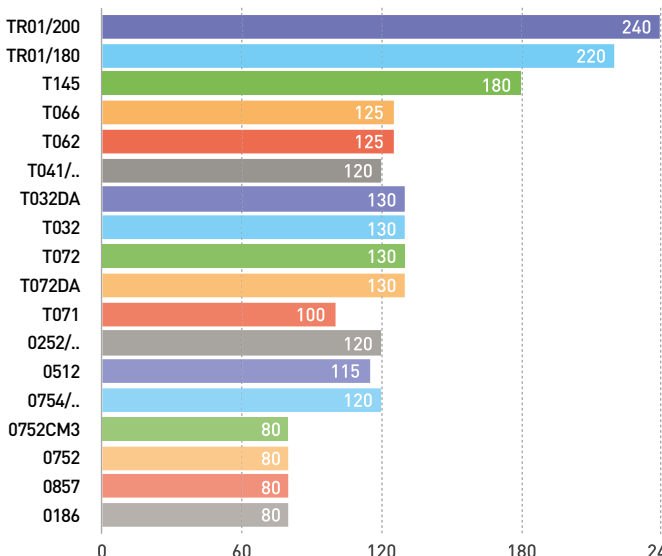

Column diameter (mm)

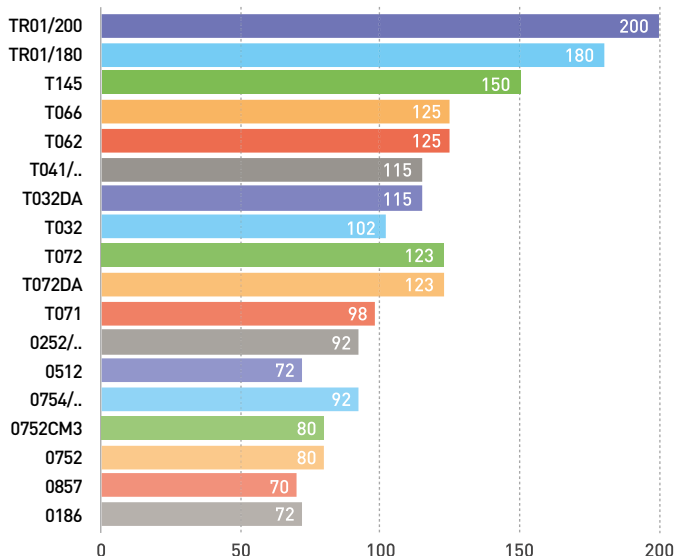
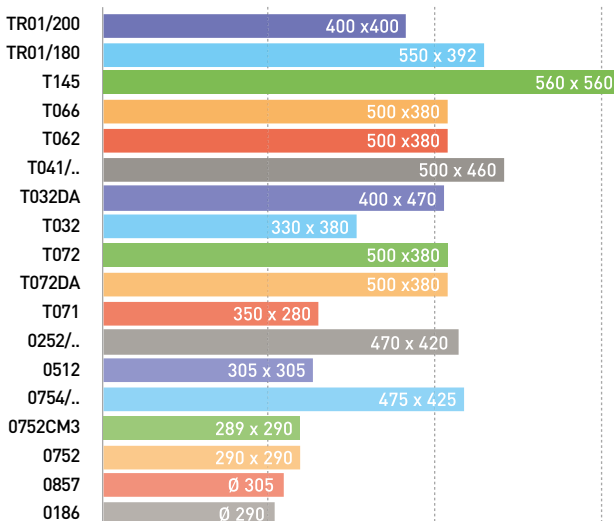

Table dimensions (mm)



TR01/200

€ 13910,00

RADIAL DRILLING MACHINE

REVERSIBLE, WITH AUTOMATIC FEEDING, COOLANT SYSTEM, EQUIPPED WITH LED LIGHT

ACCESSORIES INCLUDED

- Drill chuck with key 3 ÷ 13 mm B18
- Spindle drilled MT 4 B18
- Reduction sleeve MT 4/3
- Reduction sleeve MT 3/2

- 1 **Automatic ascent**
- 2 **Working lamp and coolant pump**
- 3 **Bloc**
- 4 **Automatic feeding**

Max drilling capacity on cast iron with pre-drilling hole	Ø 50 mm
Max drilling capacity on steel with pre-drilling hole[s235jr]	Ø 40 mm
Continuous drilling capacity	Ø 36 mm
Spindle taper MT	4
Spindle travel	240 mm
Approx spindle speeds	{6} 75 ÷ 1220 rpm
Feed range	{3} 0,1 - 0,16 - 0,25 mm/g
Quill	Ø 70 mm
Distance between spindle axis and column	1020 mm
Distance between spindle nose and table	860 mm
Distance between spindle nose and base	1210 mm
Column	Ø 200 mm
Slot	18 mm
Cube dimension	400 x 400 x 350 mm
Base dimensions	1370 x 700 mm
Three-phase motor	400 V 50 Hz 1,5 kW
Lifting motor radial arm	400 V 50 Hz 750 W
Cooling pump	400 V 50 Hz 90 W
Overall dimensions	1760 x 770 x 2100 mm
Weight	1200 kg
Packing dimensions	1750 x 740 x 2140 mm

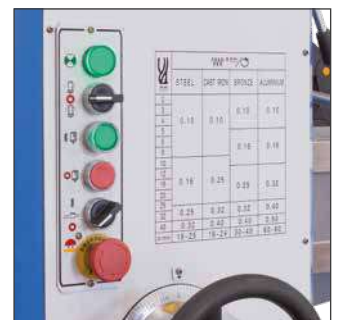

TR01/180

CAT. 42 € 8250,00

RADIAL DRILLING MACHINE

REVERSIBLE, WITH AUTOMATIC FEEDING, COOLANT SYSTEM, EQUIPPED WITH LED LIGHT



ACCESSORIES INCLUDED

Drill chuck with key 3 ÷ 16 mm B16
 Spindle drilled MT 4 B16
 Reduction sleeve MT 4/3

Max drilling capacity on cast iron with pre-drilling hole	40 mm
Max drilling capacity on steel with pre-drilling hole(s235jr)	32 mm
Continuous drilling capacity	28 mm
Spindle taper MT	4
Spindle travel	220 mm
Approx spindle speeds	{6} 76 - 130 - 240 - 360 - 660 - 1220 rpm
Feed range	{3} 0,1 - 0,16 - 0,25 mm/rev
Quill	65 mm
Distance between spindle axis and column	350 ÷ 870 mm
Distance between spindle nose and table	0 ÷ 640 mm
Distance between spindle nose and base	310 ÷ 980 mm
Column	180 mm
Slot	18 mm
Cube dimension	550 x 390 x 350 mm
Base dimensions	1300 x 650 mm
Three-phase motor	400 V 50 Hz 1,5 kW
Lifting motor radial arm	0,55 kW
Cooling pump	0,40 kW
Overall dimensions	1400 x 650 x 1900h mm
Weight	880 kg
Packing dimensions	1500 x 830 x 2000h mm



T145
CAT. 42 € 6780,00
DRILLING MACHINE

REVERSIBLE, WITH AUTOMATIC FEEDING, COOLANT SYSTEM AND EQUIPPED WITH LIGHT

ACCESSORIES INCLUDED

 Key type drill chuck 1÷13 mm B16
 Drill chuck arbor MT4 B16
 Reduction sleeve MT 4/3
 Reduction sleeve MT 3/2

Max drilling capacity on cast iron with pre-drilling hole	Ø 45 mm
Max drilling capacity on steel with pre-drilling hole(s235jr)	Ø 40 mm
Continuous drilling capacity	Ø 35 mm
Spindle taper MT	4
Spindle travel	180 mm
Approx spindle speeds	(18) 50 ÷ 1450 rpm
Feed range	(2) 0,1 - 0,20 mm/g
Quill	Ø 75 mm
Distance between spindle axis and column	350 mm
Distance between spindle nose and table	780 mm
Distance between spindle nose and base	1320 mm
Column	Ø 150 mm
Slot	18 mm
Table dimensions	560 x 560 mm
Tilting table	±90°
Base dimensions	500 x 730 mm
3 phases 2 speed motor	400 V 50 Hz 1,2 / 2,2 kW
Cooling pump	400 V 50 Hz 40 W
Net weight	500 kg
Overall dimensions	935 x 530 x 2280 mm
Weight	610 kg
Packing dimensions	1150 x 700 x 2280 mm

T066
€ 4590,00
DRILLING MACHINE

REVERSIBLE, WITH AUTOMATIC FEEDING, COOLANT SYSTEM, 145 mm VICE INCLUDED, EQUIPPED WITH LIGHT

- 1 **Induction motor**
- 2 **Gearbox levers**
- 3 **Chuck safeguard**
- 4 **Cooling pump**

Max drilling capacity on cast iron with pre-drilling hole	Ø 40 mm
Max drilling capacity on steel with pre-drilling hole(s235jr)	Ø 35 mm
Continuous drilling capacity	Ø 30mm
Spindle taper MT	4
Spindle travel	125 mm
Approx spindle speeds	(12) 75 ÷ 3200 rpm
Feed range	(3) 0,1 - 0,18 - 0,26 mm/g
Quill	Ø 75 mm
Distance between spindle axis and column	320 mm
Distance between spindle nose and table	80-680 mm
Distance between spindle nose and base	1140 mm
Column	Ø 125 mm
Slot	14 mm
Table dimensions	500 x 380 mm
Tilting table	±90°
Vice opening	125 mm
Base dimensions	470 x 670 mm
3 phases 2 speed motor	400 V 50 Hz 1,1/1,5 kW
Cooling pump	400 V 50 Hz 40 W
Overall dimensions	500 x 750 x 2000 mm
Weight	440 kg
Packing dimensions	670 x 820 x 2090 mm

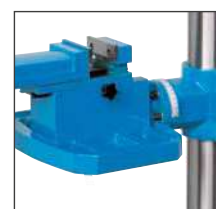
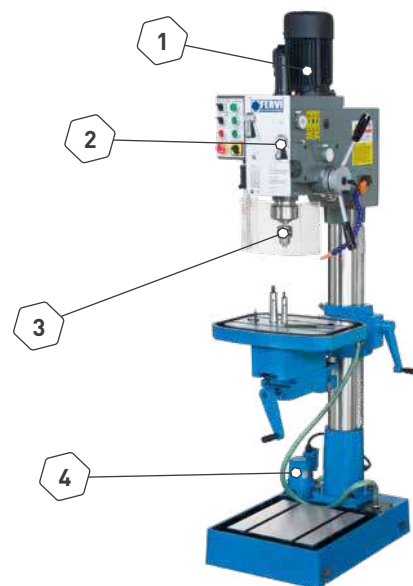

T062

€ 3860,00

GEARED DRILLING MACHINE

REVERSIBLE, 145 mm VICE INCLUDED, EQUIPPED WITH LIGHT

- 1 Induction motor 3 Chuck safeguard
2 Gearbox levers 4 Tilting table with vice included

Max drilling capacity on cast iron with pre-drilling hole	Ø 40 mm
Max drilling capacity on steel with pre-drilling hole(s235jr)	Ø 35 mm
Continuous drilling capacity	Ø 30 mm
Spindle taper MT	4
Spindle travel	125 mm
Approx spindle speeds	(12) 75 ÷ 3200 rpm
Quill	Ø 75 mm
Distance between spindle axis and column	320 mm
Distance between spindle nose and table	80 ÷ 680 mm
Distance between spindle nose and base	1140 mm
Column	Ø 125 mm
Slot	14 mm
Table dimensions	500 x 380 mm
Tilting table	±90°
Vice opening	125 mm
Base dimensions	460 x 650 mm
3 phases 2 speed motor	400 V 50 Hz 1,1/1,5 kW
Overall dimensions	500 x 750 x 2000 mm
Weight	385 kg
Packing dimensions	670 x 820 x 2090 mm

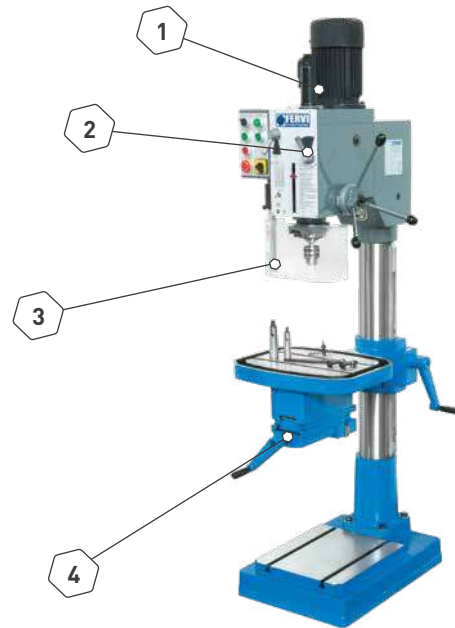

T041DA

CAT. 42 € 3780,00

GEARED DRILLING MACHINE

REVERSIBLE, TILTING HEAD, COOLING SYSTEM, TIMED TAPPING AND AUTOMATIC DOWN FEED

ACCESSORIES INCLUDED

Keyless chuck 1 ÷ 13 B16
 Drill chuck shank MT 4
 Reduction sleeve MT 4/3
 Reduction sleeve MT 3/2

Max drilling capacity on cast iron with pre-drilling hole	Ø 40 mm
Max drilling capacity on steel with pre-drilling hole(s235jr)	Ø 35 mm
Continuous drilling capacity	Ø 30 mm
Spindle taper MT	4
Spindle travel	120 mm
Approx spindle speeds	(12) 75 ÷ 3200 rpm
Feed range	(3) 0,1 - 0,18 - 0,26 mm/g
Quill	Ø 76 mm
Distance between spindle axis and column	297 mm
Distance between spindle nose and table	715 mm
Distance between spindle nose and base	1180 mm
Column	Ø 115 mm
Slot	12 mm
Table dimensions	500 x 460 mm
Head tilt left and right	±60°
Base dimensions	670 x 470 x 110 mm
3 phases 2 speed motor	400 V 50 Hz 1,1/1,5 kW
Net weight	340 kg
Gross weight	380 kg
Overall dimensions	700 x 480 x 1850 mm
Packing dimensions	730 x 760 x 1870 mm



T041
CAT. 42 € 3520,00
GEARED DRILLING MACHINE

REVERSIBLE, TILTING HEAD AND TIMED TAPPING

ACCESSORIES INCLUDED

 Keyless chuck 1 ÷ 13 B16
 Drill chuck shank MT 4
 Reduction sleeve MT 4/3
 Reduction sleeve MT 3/2

Max drilling capacity on cast iron with pre-drilling hole	Ø 40 mm
Max drilling capacity on steel with pre-drilling hole(s)-235jr)	Ø 35 mm
Continuous drilling capacity	Ø 30 mm
Spindle taper MT	4
Spindle travel	120 mm
Approx spindle speeds	(12) 75 ÷ 3200 rpm
Quill	Ø 76 mm
Distance between spindle axis and column	297 mm
Distance between spindle nose and table	715 mm
Distance between spindle nose and base	1180 mm
Column	Ø 115 mm
Slot	12 mm
Table dimensions	500 x 460 mm
Head tilt left and right	±60°
Base dimensions	650 x 450 x 80 mm
3 phases 2 speed motor	400 V 50 Hz 1,1/1,5 kW
Net weight	300 kg
Gross weight	340 kg
Overall dimensions	700 x 480 x 1820 mm
Packing dimensions	730 x 760 x 1870 mm

T032DA
€ 2900,00
FLOOR DRILL PRESS WITH DRIVE BELT

WITH AUTOFEED, COOLANT SYSTEM AND 125 mm VICE INCLUDED

1 Induction motor
2 Chuck safeguard
3 Included vice
4 Adjustable table

Max drilling capacity on cast iron with pre-drilling hole	Ø 31,75 mm
Max drilling capacity on steel with pre-drilling hole(s)235jr)	Ø 31,75 mm
Continuous drilling capacity	Ø 25 mm
Column	Ø 115 mm
Spindle travel	130 mm
Distance between spindle axis and column	223 mm
Max distance spindle nose - table	696 mm
Max distance spindle nose - base	1135 mm
Spindle taper MT	3
Approx spindle speeds	(8) 160 ÷ 2200 rpm
Feed range	0,1- 0,16- 0,26 mm/giro
Working area of the table	400 x 470 mm
Working area of the base	400 x 310 mm
Travel of table	510 mm
3 phases 2 speed motor	400 V 50 Hz 0,85 kW / 1,1 kW
Cooling pump	400 V 50 Hz 40 W
Overall sizes	900 x 545 x 1765 mm
Weight	360 kg
Packing dimensions	970 x 570 x 1910 mm

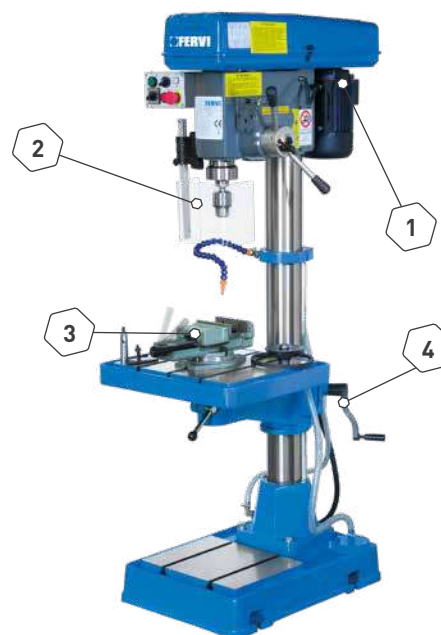

T032

€ 2360,00

FLOOR DRILL PRESS WITH DRIVE BELT

125 mm VICE INCLUDED

1 Induction motor

3 Induction motor

2 Gearbox levers

4 Chuck safeguard

Max drilling capacity on cast iron with pre-drilling hole	Ø 31,75 mm
Max drilling capacity on steel with pre-drilling hole(s235jr)	Ø 31,75 mm
Continuous drilling capacity	Ø 25 mm
Column	Ø 102 mm
Spindle travel	130 mm
Distance between spindle axis and column	230 mm
Max distance spindle nose - table	700 mm
Max distance spindle nose - base	1175 mm
Spindle taper MT	3
Approx spindle speeds	(9) 160 ÷ 1880 rpm
Working area of the table	330 x 380 mm
Working area of the base	300 x 325 mm
Travel of table	670 mm
Three-phase motor	400V 50Hz 1,5 kW
Overall sizes	900 x 430 x 1760 mm
Weight	260 kg
Packing dimensions	950 x 460 x 1910 mm



T072DA

CAT. 42 € 6370,00

FLOOR DRILLING MACHINE WITH DRIVE BELT

REVERSIBLE, WITH AUTOMATIC FEEDING, COOLANT SYSTEM, 140 mm VICE INCLUDED

ACCESSORIES INCLUDED

Drill chuck with key 1 ÷ 13 mm B16

DRILL CHUCK SHANK MT 4 B16

MORSE TAPER REDUCTION SLEEVE MT 4/3 and MT 3/2

Max drilling capacity on cast iron with pre-drilling hole	38 mm
Max drilling capacity on steel with pre-drilling hole(s235jr)	32 mm
Continuous drilling capacity	28 mm
Spindle taper MT	4
Spindle travel	130 mm
Approx spindle speeds	100 ÷ 2200 rpm
Manual vertical feed division	0,05 mm
Feed range	(3) 0,05 - 0,1 - 0,2 mm/rev
Quill	75 mm
Distance between spindle nose and table	300 mm
Distance between spindle nose and base	1220 mm
Column	123 mm
Slot	14 mm
Table dimensions	3500 x 380 mm
Tilting table	±90°
Vice opening	125 mm
Base dimensions	460 x 670 mm
3 phases 2 speed motor	400 V 50 Hz 1,1/1,9 kW
Cooling pump	400 V 50 Hz 90 W
Overall dimensions	700 x 1100 x 1900 mm
Net weight	385 kg
Weight	445 kg
Packing dimensions	610 x 1140 x 2050h mm



T072

CAT. 42 € 5150,00

FLOOR DRILLING MACHINE WITH BELT DRIVE

REVERSIBLE, 140 mm VICE INCLUDED, COOLING SYSTEM

ACCESSORIES INCLUDED

Drill chuck with key 1 ÷ 13 mm B16
 DRILL CHUCK SHANK MT 4 B16
 MORSE TAPER REDUCTION SLEEVE MT4/3 and MT3/2

Max drilling capacity on cast iron with pre-drilling hole	38 mm
Drilling capacity:Steel C60	32 mm
Continuous drilling capacity	28 mm
Spindle taper MT	4
Spindle travel	130 mm
Approx spindle speeds	100 - 2200 rpm
Manual vertical feed division	0,05 mm
Quill	75 mm
Distance spindle axis - column surface	300 mm
Distance between spindle nose and table	50 ÷ 800 mm
Distance between spindle nose and base	1220 mm
Column	123 mm
Slot	14 mm
Table dimensions	500 x 380 mm
Tilting table	±90°
Vice opening	125 mm
Base dimensions	610 x 670 mm
Cooling pump	400 V 50 Hz 90 W
3 phases 2 speed motor	400 V 50 Hz 1,1 - 1,9 kW
Overall dimensions	700 x 1100 x 1900 mm
Net weight	375 kg
Weight	435 kg
Packing dimensions	610 x 1140 x 2050h mm



T071

€ 2530,00

FLOOR DRILLING MACHINE WITH DRIVE BELT

REVERSIBLE, 120 mm VICE INCLUDED

- 1 Induction motor
- 2 Gearbox levers
- 3 Tilting table with vice included
- 4 Chuck safeguard



Max drilling capacity on cast iron with pre-drilling hole	Ø 30 mm
Max drilling capacity on steel with pre-drilling holes(235jr)	Ø 28 mm
Continuous drilling capacity	Ø 25 mm
Spindle taper MT	3
Spindle travel	100 mm
Approx spindle speeds	[16] 127 ÷ 2380 rpm
Quill	Ø 62 mm
Distance between spindle axis and column	203 mm
Distance between spindle nose and table	145-895 mm
Distance between spindle nose and base	1200 mm
Column	Ø 98 mm
Slot	12 mm
Table dimensions	350 x 280 mm
Tilting table	±90°
Vice opening	90 mm
Base dimensions	410 x 560 mm
3 phases 2 speed motor	400 V 50 Hz 0,5 / 1 kW
Overall dimensions	530 x 820 x 1700 mm
Weight	240 kg
Packing dimensions	570 x 815 x 1810 mm

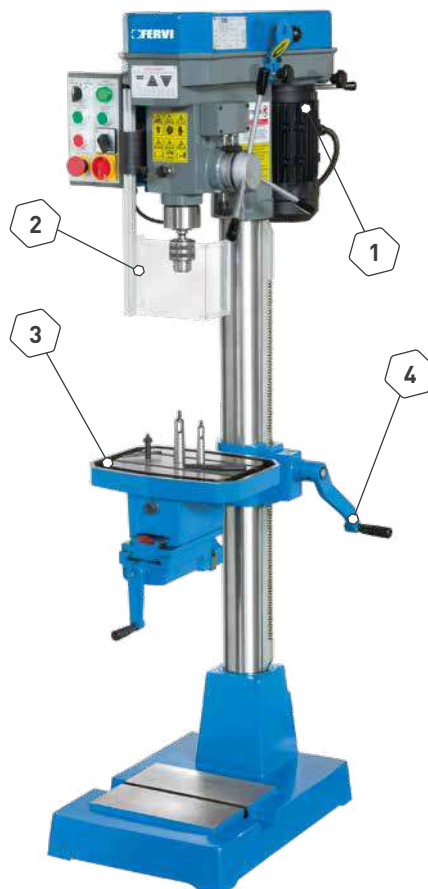

0252/230V & 0252/400V

€ 1500,00

FLOOR DRILL PRESS WITH DRIVE BELT

NEW BELT TENSION DEVICE, SELF CENTERING VICE, DRILLING DEPTH READOUT, LED LIGHT INCLUDED



Max drilling capacity on cast iron with pre-drilling hole	Ø 32 mm
Max drilling capacity on steel with pre-drilling holes-235jr]	Ø 28 mm
Continuous drilling capacity	Ø 20 mm
Vice	120 x 155 mm
Slot	14 mm
Self-centering chuck MT	4 - Ø 16 mm
Table dimensions	470 x 420 mm
Spindle travel	120 mm
Height	1720 mm
Distance chuck-column	255 mm
Distance between spindle nose and table	700 mm
Quill	Ø 62 mm
Column	Ø 92 mm
Distance between spindle nose and base	1220 mm
Approx spindle speeds	(12) 150 ÷ 2450 rpm
Motor	230 V 50 Hz 1,5 kW 400 V 50 Hz 1,5 kW
Weight	160 kg



0512

€ 1420,00

FLOOR DRILL PRESS WITH DOUBLE TABLE

WITH VARIABLE SPEED DRIVE BELT. TWO TABLES FOR WOOD AND METAL WORKING, SWIVELING AND CROSS TILTING (0 ÷ ±45°) METAL WORKING TABLE, CROSS (0 ÷ ±45°) AND FRONTAL (0 ÷ 45°) TILTING WOOD WORKING TABLE, LED LIGHT AND DIGITAL SPINDLE SPEED READOUT

- 1 Induction motor
- 2 Chuck safeguard
- 3 Swivel table for wood
- 4 Tilting table for iron



Max drilling capacity on cast iron with pre-drilling hole	Ø 25 mm
Max drilling capacity on steel with pre-drilling holes(235jr)	Ø 20 mm
Continuous drilling capacity	Ø 16 mm
Single-phase motor	230 V 50 Hz 0.9 kW
Self-centering chuck MT	2 - Ø 16 mm
Spindle travel	115 mm
Column	Ø 72 mm
Distance spindle axis - column surface	190 mm
Variable speed	420 ÷ 1950 rpm
Working area of the table for metals	305 x 305 mm
Working area of the table for wood	600 x 300 mm
Travel of table	490 mm
Dimensions	610 x 830 x 1550 mm
Weight	90 kg
Packing dimensions	1150 x 500 x 300 mm



0754/230V & 0754/400V

€ 1290,00

FLOOR DRILL PRESS WITH DRIVE BELT

INCLINABLE TABLE

- 1 Induction motor
- 2 Table lifting wheel
- 3 Casted head
- 4 Tilting base



Max drilling capacity on cast iron with pre-drilling hole	Ø 32 mm
Max drilling capacity on steel with pre-drilling hole(s235jr)	Ø 28 mm
Continuous drilling capacity	Ø 20 mm
Table dimensions	475 x 425 mm
Slot	14 mm
Self-centering chuck MT	4 - ø 20 mm
Spindle travel	120 mm
Height	1710 mm
Distance column-chuck	260 mm
Quill	Ø 62 mm
Column	Ø 92 mm
Approx spindle speeds	[12] 150 ÷ 2450 rpm
Motor	230 V 50 Hz 1,5 kW 400 V 50 Hz 1,5 kW
Weight	130 kg



0752CM3

CAT. 42 € 808,00

FLOOR DRILL PRESS WITH DRIVE BELT

INCLINABLE TABLE

0752 € 755,00

MT2 Ø 16 mm



Max drilling capacity on cast iron with pre-drilling hole	Ø 25 mm
Max drilling capacity on steel with pre-drilling hole(s235jr)	Ø 20 mm
Continuous drilling capacity	Ø 16 mm
Self-centering chuck MT	3 - ø 16 mm
Spindle travel	80 mm
Height	1630 mm
Table dimensions	290 x 290 mm
Distance spindle axis - column surface	178 mm
Distance between spindle nose and base	1170 mm
Quill	Ø 47 mm
Column	Ø 80 mm
Approx spindle speeds	[12] 180 ÷ 2740 rpm
Single-phase motor	230 V 50 Hz 0,75 kW
Weight	63 kg



0186

€ 670,00

FLOOR DRILL PRESS WITH DRIVE BELT

FLOOR DRILL PRESS WITH DRIVE BELT, INCLINABLE AND ROTATING TABLE

- 1 Induction motor
- 2 Table lifting wheel
- 3 Casted head
- 4 Tilting and swivel base



Max drilling capacity on cast iron with pre-drilling hole	Ø 20 mm
Max drilling capacity on steel with pre-drilling hole(s235jr)	Ø 16 mm
Continuous drilling capacity	Ø 12 mm
Self-centering chuck MT	2 - ø 16 mm
Spindle travel	80 mm
Height	1580 mm
Table dimensions	ø 290 mm
Distance spindle axis - column surface	162 mm
Distance between spindle nose and base	1110 mm
Quill	ø 40 mm
Column	ø 72 mm
Approx spindle speeds	{12} 280 ÷ 2380 rpm
Single-phase motor	230 V 50 Hz 0,65 kW
Weight	50 kg



0857

€ 730,00

RADIAL FLOOR DRILL PRESS WITH DRIVE BELT

ROTATING AND INCLINABLE TABLE

ACCESSORIES INCLUDED

Keyless chuck ø16 mm B16
Chuck mount MT 2



Max drilling capacity on cast iron with pre-drilling hole	Ø 20 mm
Max drilling capacity on steel with pre-drilling hole(s235jr)	Ø 16 mm
Continuous drilling capacity	Ø 12 mm
Self-centering chuck MT	2 - ø 16 mm
Spindle travel	80 mm
Height	1630 mm
Distance chuck-column	430 mm
Sliding travel	280 mm
Table dimensions	ø 305 mm
Head tilt left and right	90° L ; 45° R
Quill	ø 40 mm
Column	ø 70 mm
Distance between spindle nose and base	1285 mm
Approx spindle speeds	{5} 500 ÷ 2450 rpm
Single-phase motor	230 V 50 Hz 0,55 kW
Weight	61 kg



BENCH DRILL PRESSES



CM

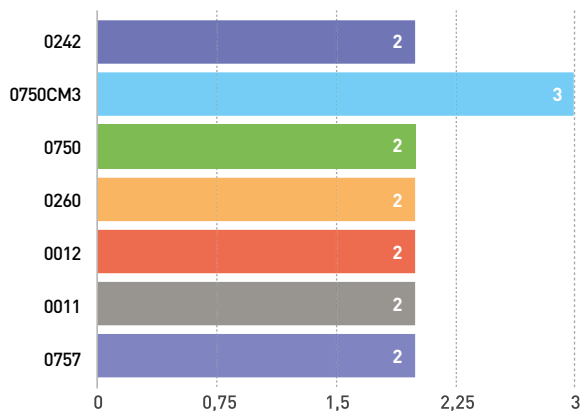

Spindle travel (mm)

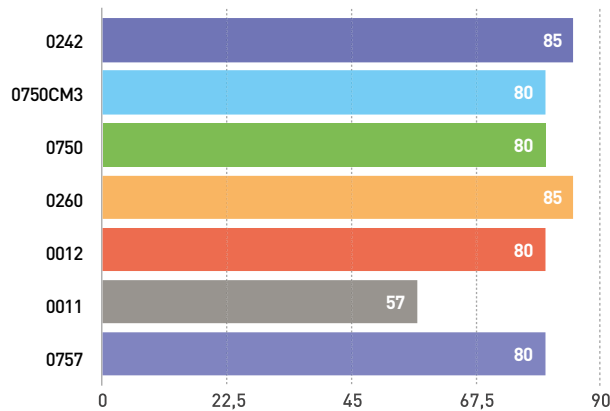

Column diameter (mm)

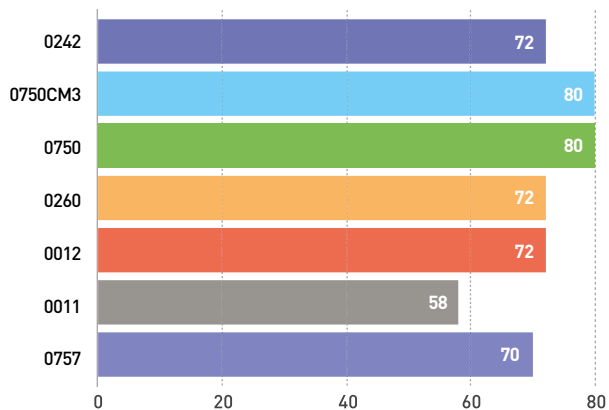
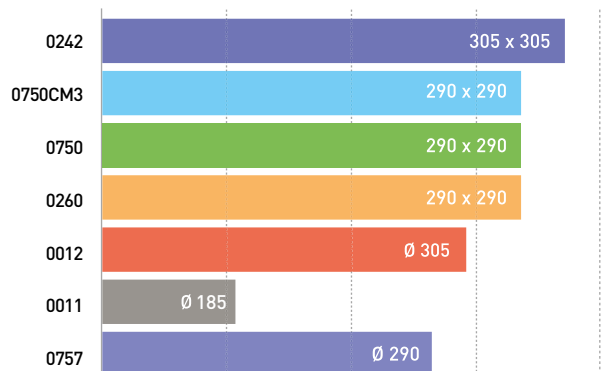

Table dimensions (mm)



0242

€ 721,00

DRILL PRESS WITH DRIVE BELT

NEW BELT TENSION DEVICE, DRILLING DEPTH READOUT, LED LIGHT INCLUDED, INCLINABLE TABLE

- 1 Induction motor
- 2 Table lifting wheel
- 3 Working lamp
- 4 Tilting base



Max drilling capacity on cast iron with pre-drilling hole	Ø 25 mm
Max drilling capacity on steel with pre-drilling hole(s235jr)	Ø 20 mm
Continuous drilling capacity	Ø 16 mm
Self-centering chuck MT	2 - Ø 16 mm
Table dimensions	305 x 305 mm
Slot	16 mm
Spindle travel	85 mm
Height	990 mm
Distance chuck-column	180 mm
Distance between spindle nose and table	420 mm
Quill	Ø 47 mm
Column	Ø 72 mm
Distance between spindle nose and base	600 mm
Approx spindle speeds	(16) 180 ÷ 2770 rpm
Single-phase motor	230 V 50 Hz 0,75 kW
Weight	60 kg



0750CM3

CAT. 42 € 716,00

DRILL PRESS WITH DRIVE BELT

INCLINABLE TABLE

0750 € 675,00

MT2 Ø 16 mm



Max drilling capacity on cast iron with pre-drilling hole	Ø 25 mm
Max drilling capacity on steel with pre-drilling hole(s235jr)	Ø 20 mm
Continuous drilling capacity	Ø 16 mm
Self-centering chuck MT	3 - Ø 16 mm
Spindle travel	80 mm
Height	980 mm
Table dimensions	290 x 290 mm
Distance spindle axis - column surface	178 mm
Quill	Ø 47 mm
Column	Ø 80 mm
Distance between spindle nose and base	650 mm
Approx spindle speeds	(12) 180 ÷ 2740 rpm
Single-phase motor	230 V 50 Hz 0,75 kW
Weight	58 kg



0260

€ 635,00

DRILL PRESS WITH DRIVE BELT

NEW BELT TENSION DEVICE, DRILLING DEPTH READOUT, LED LIGHT INCLUDED, INCLINABLE TABLE

- 1 Induction motor
- 2 Table lifting wheel
- 3 Working lamp
- 4 Tilting base



Max drilling capacity on cast iron with pre-drilling hole	Ø 20 mm
Max drilling capacity on steel with pre-drilling hole(s235jr)	Ø 16 mm
Continuous drilling capacity	Ø 12 mm
Self-centering chuck MT	2 - Ø 13 mm
Table dimensions	290 x 290 mm
Slot	16 mm
Spindle travel	85 mm
Height	980 mm
Max drilling capacity on cast iron with pre-drilling hole	Ø 20 mm
Distance chuck-column	162 mm
Distance between spindle nose and table	435 mm
Quill	Ø 40 mm
Column	Ø 72 mm
Distance between spindle nose and base	625 mm
Approx spindle speeds	(16) 180 ÷ 2770 rpm
Single-phase motor	230 V 50 Hz 550 W
Weight	50 kg



0012

€ 496,00

DRILL PRESS WITH DRIVE BELT

INCLINABLE AND ROTATING TABLE

- 1 Induction motor
- 2 Table lifting wheel
- 3 Casted head
- 4 Tilting and swivel base



Max drilling capacity on cast iron with pre-drilling hole	Ø 20 mm
Max drilling capacity on steel with pre-drilling hole(s235jr)	Ø 16 mm
Continuous drilling capacity	Ø 12 mm
Self-centering chuck MT	2 - Ø 16 mm
Spindle travel	80 mm
Height	990 mm
Table dimensions	Ø 290 mm
Distance spindle axis - column surface	160 mm
Quill	Ø 40 mm
Column	Ø 72 mm
Distance between spindle nose and base	650 mm
Approx spindle speeds	(12) 280 ÷ 2380 rpm
Single-phase motor	230 V 50 Hz 0,65 kW
Weight	51 kg



0011

CAT. 42 € 367,00

DRILL PRESS WITH DRIVE BELT

VERTICAL MOVEMENT OF THE TABLE WITH RACK, TILTING TABLE



Max drilling capacity on cast iron with pre-drilling hole	13 mm
Max drilling capacity on steel with pre-drilling hole(s235jr)	10 mm
Self-centering chuck	13 mm
Spindle travel	57 mm
Height	690 mm
Table dimensions	185 x 185 mm
Distance spindle axis - column surface	130 mm
Quill	40 mm
Column	58 mm
Distance between spindle nose and base	340 mm
Approx spindle speeds	(5) 620 ÷ 2620 rpm
Single-phase motor	230 V 50 Hz 0,375 kW
Net weight	25 kg
Dimensions	315 x 530 x 690h mm
Packing dimensions	570 x 410 x 275h mm
Weight	27 kg



0757

€ 558,00

DRILL PRESS WITH DRIVE BELT

ROTATING AND INCLINABLE TABLE



Max drilling capacity on cast iron with pre-drilling hole	Ø 20 mm
Max drilling capacity on steel with pre-drilling hole(s235jr)	Ø 16 mm
Continuous drilling capacity	Ø 12 mm
Self-centering chuck MT	2 - Ø 16 mm
Spindle travel	80 mm
Height	1000 mm
Sliding travel	280 mm
Distance chuck-column	430 mm
Table dimensions	Ø 305 mm
Head tilt left and right	90° L ; 45° R
Quill	Ø 40 mm
Column	Ø 70 mm
Distance between spindle nose and base	670 mm
Approx spindle speeds	(5) 500 ÷ 2450 rpm
Single-phase motor	230 V 50 Hz 0,55 kW
Weight	57 kg



0518/20

€ 649,00

MAGNETIC DRILL

WITH COOLANT SYSTEM FOR CORE DRILLS UNTIL 20 mm WITH WELDON SHANK Ø 19,05 mm AND STRAIGHT SHANK DRILLS UNTIL Ø 20 mm WITH REDUCED SHANK Ø 13 mm

Key chuck	Ø 13 mm
Arbor	Weldon Ø 19,05 mm
Spindle travel	165 mm
Max. magnetic force	8500 N
Approx spindle speeds	650 rpm
Single-phase motor	230 V 50 Hz 0.9 kW
Dimensions	300 x 260 x 450 mm
BMC	442 x 395 x 175 mm
Weight	18,5 kg

0518/30

€ 883,00

MAGNETIC DRILL

WITH COOLANT SYSTEM FOR CORE DRILLS UNTIL 30 mm WITH WELDON SHANK Ø 19,05 mm AND STRAIGHT SHANK DRILLS UNTIL Ø 20 mm WITH REDUCED SHANK Ø 13 - 16 mm

Key chuck	Ø 16 mm
Arbor	Weldon Ø 19,05 mm
Spindle travel	175 mm
Max. magnetic force	11000 N
Approx spindle speeds	450 rpm
Single-phase motor	230 V 50 Hz 1.1 kW
Base dimensions	170 x 90 mm
Dimensions	360 x 280 x 490 mm
BMC	527 x 472 x 242 mm
Weight	27 kg

0518/50

€ 1210,00

MAGNETIC DRILL

WITH COOLANT SYSTEM FOR CORE DRILLS UNTIL 50 mm WITH WELDON SHANK Ø 19,05 mm, MORSE TAPER SHANK DRILLS MT 3 AND STRAIGHT SHANK DRILLS UNTIL Ø 20 mm WITH REDUCED SHANK Ø 13 - 16 mm

Key chuck	Ø 16 mm
MT chuck	3 - Weldon Ø 19,05 mm
Spindle taper MT	3
Spindle travel	220 mm
Max. magnetic force	15000 N
Approx spindle speeds	400, 600 rpm
Single-phase motor	230 V 50 Hz 1.5 kW
Base dimensions	205 x 110 mm
Dimensions	400 x 310 x 475 mm
BMC	587 x 489 x 265 mm
Weight	37,5 kg



0518/38M

CAT. 42 € 1000,00

MAGNETIC TAPPING/DRILL

WITH COOLANT SYSTEM FOR CORE DRILLS UNTIL 38 mm WITH WELDON SHANK Ø 19,05 mm AND STRAIGHT SHANK DRILLS UNTIL Ø 20 mm WITH REDUCED SHANK Ø 13 - 16 mm, TAPPING CAPACITY M4 - M16

Key chuck	Ø 16 mm
MT chuck	3 - Weldon Ø 19,05 mm
Spindle taper MT	2
Spindle travel	180 mm
Tapping capacity	M4 ÷ M16
Max. magnetic force	12000 N
Approx spindle speeds	0 ÷ 500 / 0 ÷ 800 rpm
Single-phase motor	230 V 50 Hz 1.05 kW
Base dimensions	205 x 105 mm
Dimensions	280 x 320 x 510h mm
Weight	19,8 kg
Weight	21 kg
Packing dimensions	450 x 190 x 545 mm

**0518/55H**

CAT. 42 € 1250,00

HORIZONTAL MAGNETIC DRILL

FOR CORE DRILLS UNTIL 55 mm WITH WELDON SHANK Ø 19.05 mm

Chuck sizes	Weldon Ø 19,05 mm
Spindle travel	45 mm
Max. magnetic force	15500 N
Approx spindle speeds	640 rpm
Single-phase motor	230 V 50 Hz 1,9 kW
Base dimensions	165 x 80 mm
Dimensions	350 x 150 x 170h mm
BMC	400 x 200 x 240 mm
Net weight	8,5 kg
Weight	10 kg
Packing dimensions	350 x 150 x 170h mm

**0518/80**

CAT. 42 € 1560,00

MAGNETIC DRILL

WITH COOLANT SYSTEM FOR CORE DRILLS UNTIL 80 mm WITH WELDON SHANK Ø 19.05 mm, MORSE TAPER SHANK DRILLS MT 3 AND STRAIGHT SHANK DRILLS UNTIL Ø 20 mm WITH REDUCED SHANK Ø 13 - 16 mm

MT chuck	3 - Weldon Ø 19,05 mm
Spindle taper MT	3
Spindle travel	280 mm
Max. magnetic force	20000 N
Approx spindle speeds	230 / 360 / 500 / 770 rpm
Single-phase motor	230 V 50 Hz 1.8 kW
Base dimensions	215 x 110 mm
Dimensions	290 x 410 x 550h mm
Net weight	26 kg
Packing dimensions	470 x 210 x 570 h mm
Weight	39 kg



COMPATIBILITY CHART

ART.	€	TR01/200	TR01/180	T145	T066	T062	T041DA	T041	T032DA	T032	T071	T072DA	T072	0512	0252/230V	0252/400V	0756/230V	0756/400V	0752CM3	0752	0750CM3	0750	0242	0240	0186	0011	0012	0757	0857	0518/20	0518/30	0518/50	0518/38M	0518/55H	0518/80	PAG		
0142/75	17,30																																					145
0142/100	24,50																																					145
0142/125	30,50																																					145
M001/100	50,00																																					145
M001/120	61,40																																					145
M001/150	77,00																																					145
M027/100	133,00																																					145
M027/140	187,00																																					145
M027/200	303,00																																					145
0698/100	77,40																																					146
0188/100	72,70																																					146
0188/125	103,00																																					146
0188/150	130,00																																					146
0188/100G	123,00																																					146
0188/150G	158,00																																					146
K001/12	92,70																																					154
K001/14	103,00																																					154
K001/18	150,00																																					154
K002/12	29,20																																					154
K002/14	34,30																																					154
ST45/2/1	9,50																																					156
ST45/3/1	11,60																																					156
ST45/3/2	12,40																																					156
ST45/4/1	16,00																																					156
ST45/4/2	16,00																																					156
ST45/4/3	16,00																																					156
M059/07	405,00																																					161
M059/12	464,00																																					161
M059/20	568,00																																					161
M060/3	374,00																																					161
M060/4	400,00																																					161
M004/2	149,00																																					161
M004/3	149,00																																					161
P018/230V	282,00																																					172
P018/400V	282,00																																					172
0599	309,00																																					36
T201	15,10																																					172
0532A/230V	163,00																																					174
S001	78,40																																					238
L020	83,10																																					234
F430	62,70																																					237
P046	26,40																																					209
P058/170	149,00																																					210
P010/41	120,00																																					210
P057	86,30																																					218
0238	9,80																																					231
0712/009	83,10																																					224
F001/10	192,00																																					235
F002/6	238,00																																					221
F011/6	156,00																																					219

0273

€ 3100,00

METAL BAND SAW WITH MANUAL AND HYDRAULIC FEED

WITH BLADE TENSION REGULATION TOOL, COOLANT SYSTEM, QUICK VICE

**ACCESSORIES INCLUDED**

Blade tension gauge
Coolant pump
Quick vice



Blade dimensions	2450 x 27 x 0,9 mm
Three-phase motor	400V 50 HZ 0,59 / 1,1 kW
Speeds	36 - 72 m/min
Cut range	0° ÷ 60°
Cutting capacity	90° • 220 mm ■ 150 mm — 260 mm
Cutting capacity	45° • 150 mm ■ 145 mm — 150 mm
Net weight	220 kg
Gross weight	264 kg



0692/230V & 0692/400V

€ 2450,00

METAL BAND SAW WITH MANUAL AND HYDRAULIC FEED

WITH BLADE TENSION REGULATION TOOL, COOLANT SYSTEM, QUICK VICE

ACCESSORIES INCLUDED

Blade tension gauge
Coolant pump
Quick vice



Blade dimensions	2100 x 20 x 0,9 mm
Motor	230V 50 Hz 0,75 kW 400V 50 HZ 0,55 / 0,9 kW
Speeds	40 rpm
Cut range	0° ÷ 60°
Cutting capacity	90° • 170 mm ■ 140 mm — 210 mm
Cutting capacity	45° • 120 mm ■ 95 mm — 140 mm
Weight	170 kg



0255
METAL BAND SAW

WITH COOLANT SYSTEM, QUICK VICE, BASE WITH CABINET TOOLS

€ 1290,00

Blade dimensions	1735 x 13 x 0,65 mm
Cut range	0 ÷ 60°
Cutting speed	34 m / min
Single-phase motor	230 V 50 Hz 0,5 kW
Cutting capacity	90° — 150 x 140 mm • 140 mm
Cutting capacity	45° — 140 x 105 mm • 105 mm
Weight	89 kg

0362
CUTTING BAND SAW

ELECTRONIC CUTTING BAND SAW FOR BENCH WITH INVERTER MOTOR

€ 622,00

Blade dimensions	1435 x 12,7 x 0,65 mm
Cut range	0° ÷ 60°
Single-phase motor	230 V 50 Hz 0,4 kW
Cutting capacity	90° • 125 mm ■ 125 mm
Cutting capacity	45° • 76 mm ■ 76 mm
Weight	22 kg

0500
ELECTRONIC CUTTING BAND SAW FOR BENCH

WITH BRUSH MOTOR

€ 511,00

Blade dimensions	1140 x 13 x 0,65 mm
Speeds	20-70 m / min
Cut range	0° ÷ 45°
Single-phase motor	230 V 50 Hz 1,8 kW
Cutting capacity	90° • 105 mm — 110 x 105 mm
Cutting capacity	45° • 55 mm — 55 x 60 mm
Vice	100 x 54 mm
Vice opening	125 mm
Weight	20 kg

0132
CUTTING BAND SAW

BENCH TYPE, EASY TO CARRY, WITH TWO CUTTING SPEED

CAT. 42 € 392,00

Blade sizes	1335 x 12,7 x 0,65 mm
Speeds	(2) 60 / 80 m / min
Cut range	0° ÷ 45°
Single-phase motor	230 V 50 Hz 0,850 kW
Cutting depth at 90°	• 105 mm — 105 x 93 mm
Cutting depth at 45°	• 72 mm — 70 x 60 mm



COMPATIBILITY CHART

Art.	€	0273	0692/230V	0692/400V	0255	0362	0500	0132	PAG
0133	116,00	•	•	•	•				61
R001/04	275,00	•	•	•	•				61
R001/07	386,00	•	•	•	•				61
0522	206,00					•	•		61
LB01/1140	14,50						•		258
LB02/1140	14,50						•		258
LB01/1335	16,20							•	258
LB01/1435	17,10					•			258
LB02/1435	17,10					•			258
LB01/1735	19,70				•				258
LB05/1735	20,30				•				258
LB07/2100	24,70		•	•					258
LB08/2100	24,70		•	•					258
LB09/2450	29,20	•							258
LB10/2450	29,20	•							258
0532A/230V	163,00	•	•	•	•				174



0522

€ 206,00

FOLDING STAND



Capacity	150 kg
Table dimensions	820 x 460 mm
Working height	600 - 715 - 745 - 770 - 795 - 820 mm
Rollers distance	870 - 1070 - 1350 mm
Rollers height	37 ÷ 470 mm
Weight	17 kg

0133

€ 116,00

ROLLER STAND



Roller dimensions	Ø 52 x 350 mm
Height	690 / 1200 mm
Lifting capacity	50 ÷ 60 kg
Weight	17 kg

R001-

ADJUSTABLE HEIGHT ROLLER STAND

WITH 4 IDLER ROLLERS



Art.	€	Dimensions	Rollers distance	Roller dimensions	Height	Lifting capacity	Weight
R001/04	€ 275,00	1000 x 460 mm	260 mm	Ø 60 x 360 mm M12	580 / 1030 mm	400 kg	27 kg
R001/07	€ 386,00	2000 x 460 mm	260 mm	Ø 60 x 360 mm M12	580 / 1030 mm	400 kg	45 kg

0642

€ 270,00

CUT-OFF MACHINE



Single-phase motor	230 V 50 Hz 2 kW
Disc dimensions	355 x 3.0 x 25.4 mm
Disc speed	3800 rpm
Cut range	± 45°
Cutting capacity	■ 100 x 100 mm - ■ 200 x 40 mm - ○ 100 mm
Vice opening	155 mm - 190 mm - 230 mm
Weight	20 kg

0565

€ 136,00

FLEXIBLE SHAFT GRINDER



Precision key type chuck	0 - 4 mm
Variable speed	500 ÷ 22000 rpm
Flexible shaft length	900 mm
Single-phase motor	230 V 50 Hz 185 W

0568

€ 45,70

MULTI CUTTING POWER TOOLS SET

WITH ADJUSTABLE STAND AND FLEXIBLE SHAFT GRINDER



Precision key type chuck	Ø 3 mm
Variable speed	8000 ÷ 32500 rpm
Flexible shaft length	1000 mm
Stand height	650 mm
Clamp capacity	65 mm
Single-phase motor	230 V 50 Hz 135 W



GRINDERS

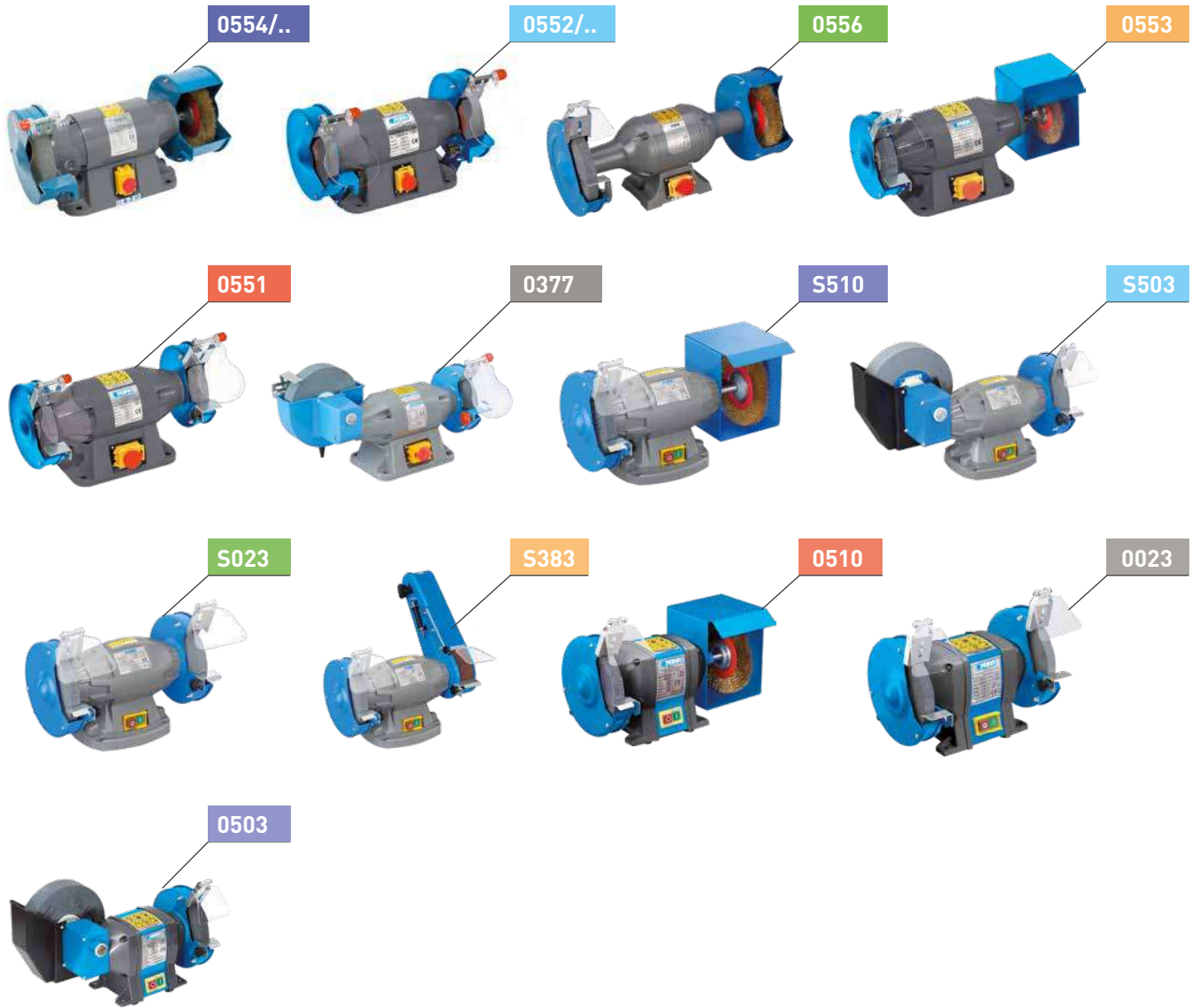

Power (kW)

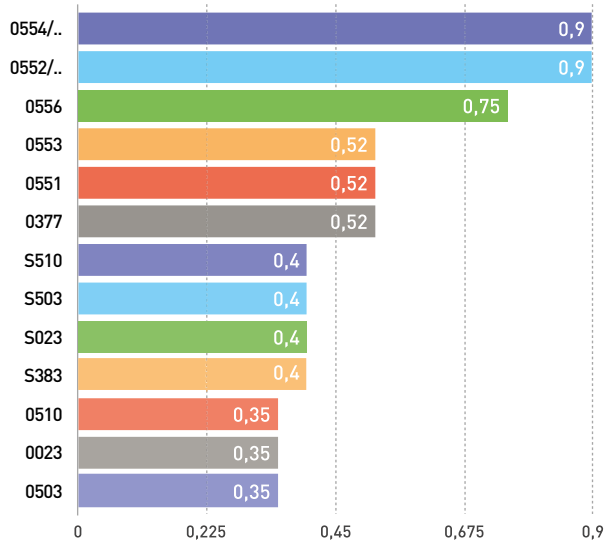

Weight (Kg)

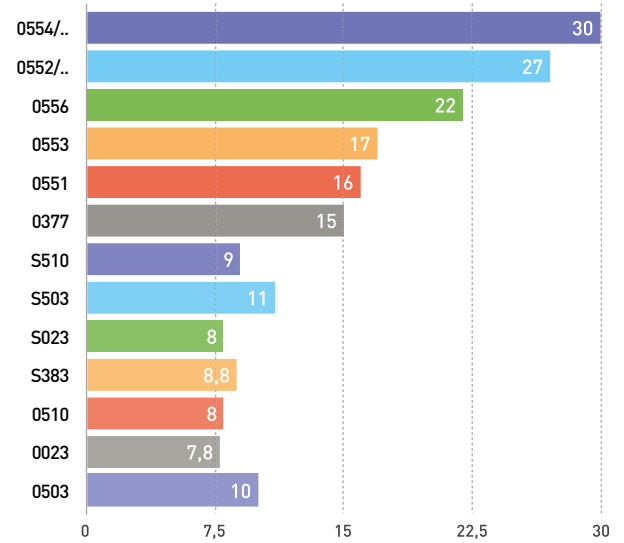



0554 & 0554/400V

€ 275,00

PROFESSIONAL COMBINED BENCH GRINDER



Brush	2950 rpm - Ø 200 x 25 x 20 mm
Grinding wheel	2950 rpm - Ø 200 x 25 x 20 mm GR36
Motor	230V 50 Hz 0,9 kW 400V 50 Hz 0,9 kW
Weight	30 kg

0552 & 0552/400V

€ 253,00

PROFESSIONAL BENCH GRINDER



Grinding wheel	2950 rpm - Ø 200 x 25 x 20 mm GR36 - GR80
Motor	230V 50Hz 0,9 kW 400V 50 Hz 0,9 kW
Weight	27 kg

0556

€ 199,00

PROFESSIONAL COMBINED BENCH GRINDER WITH LONG ARMS



Brush	2950 rpm - Ø 200 x 25 x 20 mm
Grinding wheel	2950 rpm - Ø 200 x 25 x 20 mm GR36
Single-phase motor	230 V 50 Hz 0,75 kW
Weight	22 kg

0553

€ 172,00

PROFESSIONAL COMBINED BENCH GRINDER



Brush	2950 rpm - Ø 150 x 20 x 16 mm
Grinding wheel	2950 rpm - Ø 150 x 20 x 16 mm GR36
Single-phase motor	230 V 50 Hz 0,52 kW
Weight	17 kg

0551

€ 160,00

PROFESSIONAL BENCH GRINDER



Grinding wheel	2950 rpm - Ø 150 x 20 x 16 mm GR36 - GR80
Single-phase motor	230 V 50 Hz 0,52 kW
Weight	16 kg

0377

€ 199,00

COMBINED BENCH GRINDER



Wet grinding wheel	130 rpm - Ø 200 x 40 x 20 mm GR80
Dry grinding wheel	2950 rpm - Ø 150 x 20 x 16 mm GR80
Single-phase motor	230 V 50 Hz 0,52 kW
Weight	15 kg

S510

€ 120,00

BENCH GRINDER WITH BRUSH

WITH BRUSH AND GRINDING WHEEL, STRONG AND RELIABLE



Brush	2950 rpm - Ø 150 x 20 x 16 mm
Grinding wheel	2950 rpm - Ø 150 x 20 x 16 mm GR36
Single-phase motor	230 V 50 Hz 0,40 kW
Weight	9 kg

S503

€ 124,00

WET DRY BENCH GRINDER

WITH WET GRINDING WHEEL AND DRY GRINDING WHEEL, STRONG AND RELIABLE



Wet grinding wheel	130 rpm - Ø 200 x 40 x 20 mm GR80
Dry grinding wheel	2950 rpm - Ø 150 x 20 x 16 mm GR80
Single-phase motor	230 V 50 Hz 0,40 kW
Weight	11 kg

S023

€ 108,00

BENCH GRINDER

WITH TWO GRINDING WHEELS OF DIFFERENT GRAIN, STRONG AND RELIABLE



Grinding wheel	2950 rpm - Ø 150 x 20 x 16 mm GR36
Grinding wheel	2950 rpm - Ø 150 x 20 x 16 mm GR80
Single-phase motor	230 V 50 Hz 0,40 kW
Weight	8 kg

S383

CAT. 42 € 137,00

BENCH GRINDER WITH BELT

STRONG AND RELIABLE



Belt	50 x 686 mm GR100
Grinding wheel	2950 rpm Ø 150 x 20 x 16 mm GR36
Single-phase motor	230 V 50 Hz 0,40 kW
Weight	8,8 kg

0510

€ 87,60

BENCH GRINDER WITH BRUSH



Brush	2950 rpm - Ø 150 x 20 x 12,7 mm
Grinding wheel	2950 rpm - Ø 150 x 20 x 12,7 mm GR36
Single-phase motor	230 V 50 Hz 0,35 kW
Weight	8 kg

0023

€ 79,40

BENCH GRINDER



Grinding wheel	2950 rpm - Ø 150 x 20 x 12,7 mm GR36 - GR80
Single-phase motor	2950 rpm - 230 V 50 Hz 0,35 kW
Weight	7,8 kg



0503

€ 90,10

WET DRY BENCH GRINDER



Wet grinding wheel	130 rpm - Ø 200 x 40 x 20 mm GR80
Dry grinding wheel	2950 rpm - Ø 150 x 20 x 12,7 mm GR80
Single-phase motor	230 V 50 Hz 0,35 kW
Weight	10 kg

0555

€ 100,00

GRINDING WHEEL STAND



Height	760 mm
Column	Ø 75 mm
Table dimensions	320 x 210 mm
Weight	16 kg

0106

€ 77,30

GRINDING WHEEL STAND

LIGHT DUTY



Height	760 mm
Column	Ø 75 mm
Table dimensions	320 x 210 mm
Weight	12 kg

COMPATIBILITY CHART

Art.	€	S 383	0510	S510	0503	S503	0023	S023	0551	0552	0552/400V	0553	0554	0554/400V	0556	0377	PAG
0555	100,00	•	•	•	•	•	•	•	•	•	•	•	•	•	•	•	66
0106	77,30	•	•	•	•	•	•	•	•	•	•	•	•	•	•	•	66
SRF150/25	7,00		•	•								•					554
SRF200/25	10,00												•				554
SRF150/25I	12,70		•	•								•					554
SRF200/25I	18,60												•	•	•		554
SRR150	10,00		•	•								•					554
SRR200	14,30												•	•	•		554
MV01/80	11,00	•	•	•	•	•	•	•	•			•				•	536
MV02/80	13,10									•	•		•	•	•		536
MV03/80	16,00									•	•		•	•	•		536
MG01-	-	•	•	•	•	•	•	•	•			•				•	-
MG02-	-									•	•		•	•	•		-
MG03-	-									•	•		•	•	•		-
MG06/80	17,40			•	•											•	536
MB01/60	6,90	•	•	•	•	•	•	•	•			•				•	536
MB02/60	7,30									•	•		•	•	•		536
MB03/60	9,80									•	•		•	•	•		536
A040/30A	148,00									•	•		•	•	•		109
A040/60A	240,00									•	•		•	•	•		109
A024/602	233,00									•	•		•	•	•		110

0316

€ 142,00

ELECTRIC CHAINSAW SHARPENER



Pink grinding wheel	Ø 145 x 4,7 x 22,3 mm
Sharpening	+30° / -35°
For chains	1/4" - 3/25" - 3/8" - 4/4" - 3/4"
Single-phase motor	230 V 50 Hz 0,23 kW
Weight	5 kg

0502

€ 66,70

POWER CHAINSAW SHARPENER



Pink grinding wheel	Ø 100 x 4,5 x 10 mm
Sharpening	+35° / -35°
For chains	1/4" - 0,325" / 3/8" - 0,404"
Single-phase motor	230 V 50 Hz 0,25 kW
Weight	1,8 kg

A003/32

CAT. 42 € 2320,00

TWIST DRILLS GRINDING MACHINE

IN HSS, FROM 3 TO 32 mm AND TWIST DRILLS IN HARD METAL BY MOUNTING THE OPTIONAL WHEEL



Grinding capacity	2,1 ÷ 32 mm
Tilting tip	95° ÷ 135° / 85° ÷ 140°
Speeds	4400 rpm
Single-phase motor	230 V 50 Hz 250 W
Dimensions	400 x 260 x 300 mm
Net weight	36 kg
Weight	39 kg
Packing dimensions	395 x 280 x 330h mm

A013/26

€ 998,00

TWIST DRILL GRINDING MACHINE



Grinding capacity	13 ÷ 26 mm
Tilting tip	118° ÷ 135°
Speeds	4200 rpm
Single-phase motor	230 V 50 Hz 0,2 kW
Overall sizes	370 x 165 x 200 mm
Weight	24,5 kg

A003/13A

CAT. 42 € 644,00

TWIST DRILL GRINDING MACHINE



Grinding capacity	3 ÷ 13 mm
Tilting tip	95° ÷ 135°
Speeds	4400 rpm
Single-phase motor	230 V 50 Hz 120 W
Overall sizes	320 x 180 x 190 mm
Net weight	9,0 kg
Weight	9,5 kg

0804

€ 460,00

MANUAL GRINDER FOR SAW BLADE



Grinding capacity	Ø 80 ÷ 700 mm
Speeds	2850 rpm
Single-phase motor	230 V 50 Hz 0,25 kW
Weight	39 kg

A0132A

€ 911,00

TWIST DRILL GRINDING MACHINE



Grinding capacity	3 ÷ 20 mm
Tilting tip	90° ÷ 140°
Speeds	7000 rpm
Single-phase motor	230 V 50 Hz 0,6 kW
Overall sizes	500 x 230 x 250 mm
Weight	21 kg

A059

€ 92,70

MULTIPURPOSE SHARPENER



Grinding capacity	3 - 13 mm
Speeds	3000 rpm
Single-phase motor	230 V 50 Hz 0,15 kW
Overall sizes	232 x 160 x 110 mm
Weight	2 kg

A003/32CBN € 195,00
CBN WHEEL
 FOR HSS TWIST DRILLS
 FROM 13.1 TO 32 mm

A003/32SDC € 195,00
SDC WHEEL^{FOR}
 HARD METAL
 TWIST DRILLS
 FROM 13.1 TO 32
 mm

A003/13ACBN € 107,00
CBN WHEEL
 FOR HSS TWIST DRILLS

A003/13ASDC € 107,00
SDC WHEEL
 FOR HARD METAL TWIST DRILLS

A013/26M € 139,00
DIAMOND WHEEL
 SPARE PART CBN WHEEL

A0132A/MR € 17,30
PINK GRINDING WHEEL
 THREAD M8 , Ø 40 X 38 mm INNER Ø
 26 mm

A0132A/MB € 17,30
WHITE GRINDING WHEEL
 THREAD M8 , Ø 40 X 38 mm INNER Ø
 26 mm

0804/MD € 87,50
DIAMOND WHEEL
 125 X 10 X F32 X 8 mm

A059/M € 9,30
SET 5 MOLE

COMPATIBILITY CHART

Art.	€	0316	0502	A003/13A	A013/26	A003/32	A0132A	0804	A059	PAG.
M159	6,90		•							536
M160	6,90		•							536
M162	12,70	•								536
M163	12,70	•								536
A0132A/MB	17,30						•			69
A0132A/MR	17,30						•			69
A013/26M	139,00				•					69
0804/MD	87,50							•		69
A059/M	9,30								•	69
A003/32CBN	195,00					•				69
A003/32SDC	195,00					•				69
A003/13ACBN	107,00			•		•				69
A003/13ASDC	107,00			•		•				69

0691/400V € 2030,00
TILTING BELT SANDER



Belt dimensions	2000 x 150 mm
Speeds	(2) 18 + 37 m/sec
Three-phase motor	400 V 50 Hz 4 kW
Weight	122 kg

0667/100 CAT. 42 € 975,00
TILTING BELT SANDER

WITH BENCH, FOR HORIZONTAL AND VERTICAL OPERATIONS



Belt dimensions	1000 x 100 mm
Speeds	(2) 9 / 18 m/sec
Three-phase motor	400 V 50 Hz 1,8 - 1,3 kW
Dimensions	690 x 525 x 960h mm
Net weight	60 kg



0667/150

CAT. 42 € 1150,00

TILTING BELT SANDER

WITH BENCH, FOR HORIZONTAL AND VERTICAL OPERATIONS



Belt dimensions	1500 x 120 mm
Speeds	(2) 9 / 18 m/sec
Three-phase motor	400 V 50 Hz 1,8 / 1,3 kW
Dimension	690 x 525 x 960h mm
Net weight	60 kg

0662

€ 558,00

TILTING BELT SANDER WITH BENCH

BENCH TO BE ASSEMBLED



Belt dimensions	1219 x 152 mm
Disc diameter	Ø 230 mm
Working table dimensions	330 x 152 mm
Belt speed	330 m/min
Disc speed	1400 m/min
Overall sizes	710 x 510 x 1000 mm
Single-phase motor	230 V 50 Hz 0,75 kW
Packing dimensions	705 x 455 x 385 mm
Weight	54 kg

0560

€ 571,00

BENCH CHAMFERING MACHINE

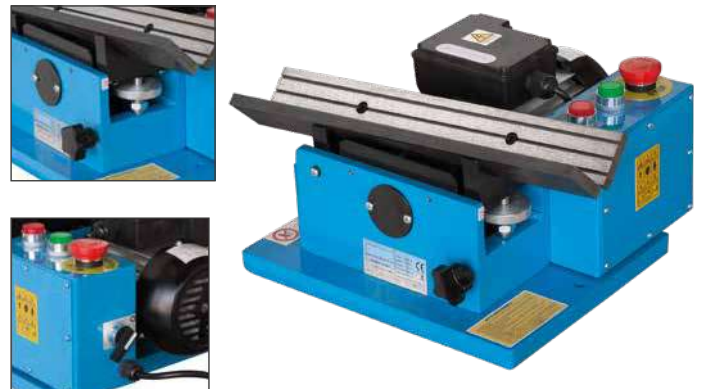

Chamfer	45° 0 - 5 mm
Speeds	2800 rpm
Single-phase motor	230 V 50 Hz 0,25 kW
Table dimensions	2 - 400 x 50 mm
Mill size	Ø 80 mm - Z 8
Insert	SPUN13P
Weight	25 kg

0022

€ 586,00

PORTABLE CHAMFERING MACHINE

SPUN13P

€ 7,70

SPARE PART INSERT

Chamfer	15° - 45° 0 - 5 mm
Speeds	2950 rpm
Single-phase motor	230 V 50 Hz 0,25 kW
Table dimensions	2 - 200 x 50 mm
Mill size	Ø 80 mm - Z 8
Insert	SPUN13P
Weight	12,5 kg



0285/75

€ 4150,00

ELECTRIC SLIP ROLLING MACHINE

WITH 3 STEEL ROLLERS WITH HARDNESS HRC52, SAFETY ROPE WITH 3 FUNCTIONS MICRO SWITCH, MOBILE CONTROLS WITH DOUBLE CONTROL PEDALS FORWARD/BACKWARD AND MUSHROOM EMERGENCY SWITCH



Bed length	1300 mm
Max thickness	1.5 mm
Roller diameter	75 mm
Three-phase motor	400 V 50 Hz 0.75 kW
Weight	310 kg

0235

€ 196,00

MINI HAND ROLL FORMING MACHINE

FOR VICE EQUIPPED WITH 3 ROLLERS, VICE NOT INCLUDED



Max rolling length	300 mm
Max thickness	2,5 mm
Roller diameter	30 mm
Weight	11 kg

0892

€ 399,00

MINI HAND SHEAR BRAKE

FOR VICE, INTERCHANGEABLE BLADE, VICE NOT INCLUDED



Working length	200 mm
Max. bending thickness	1 mm
Max. shearing thickness	1 mm
Weight	18 kg

0483

CAT. 42 € 202,00

MINI HAND BRAKE

FOR VICE, INTERCHANGEABLE BLADE, MAX BENDING WIDTH ON HANDLE SIDE 50MM, VICE NOT INCLUDED



Working length	270 mm
Max. shearing thickness	2,5 mm
Net weight	10 kg
Weight	11 kg
Packing dimensions	470 x 270 x 135 mm



0334/0750

€ 3090,00

SHEAR PRESS BRAKE AND SLIP ROLL

VERSATILE AND STRONG MACHINE, SUITABLE FOR MAKING PROTOTYPES



Bed length	750 mm
Max shearing, bending and rolling thickness	1,0 mm
Bending angle	90°
Min. rolling ø	44 mm
Overall sizes	980 x 370 x 550 mm
Weight	260 kg

0334/1000

€ 3450,00

SHEAR PRESS BRAKE AND SLIP ROLL

VERSATILE AND STRONG MACHINE, SUITABLE FOR MAKING PROTOTYPES



Bed length	1000 mm
Max shearing, bending and rolling thickness	1,0 mm
Bending angle	90°
Min. rolling ø	48 mm
Overall sizes	1335 x 455 x 620 mm
Weight	308 kg

T034/105

€ 2020,00

SHEAR MACHINE WITH STAND

WITH INTEGRATED GONIOMETER, ADJUSTABLE CUTTING END STOP AND BENCH IN ASSEMBLY KIT



Bed length	1050 mm
Max. bending thickness	1,25 mm
Cutting capacity with adjustment	0 + 500 mm
Overall sizes	1290 x 1300 x 1080 mm
Packing dimensions	1320 x 660 x 600 mm
Weight	160 kg

T034/065

€ 1160,00

SHEAR MACHINE BENCH TYPE

WITH INTEGRATED GONIOMETER AND ADJUSTABLE CUTTING END STOP



Bed length	650 mm
Max. bending thickness	1,5 mm
Cutting capacity with adjustment	0 + 500 mm
Overall sizes	890 x 1300 x 450 mm
Packing dimensions	950 x 530 x 550 mm
Weight	100 kg

P008/102

€ 2360,00

BENDING MACHINE

HIGH EFFICIENCY DUE TO TOP SEGMENTED KNIFE, STRONG AND RELIABLE STRUCTURE



Max length	1020 mm
Max. shearing thickness	2 mm
Max bending angle	135°
Weight	350 kg

0775

€ 1300,00

BENDING MACHINE



Max length	1000 mm
Max. shearing thickness	1,2 mm
Max bending angle	140°
Weight	150 kg

C076/30

CAT. 42 € 3290,00

MOTORIZED 3 ROLL PIPE & PROFILE BENDING MACHINES

HORIZONTAL AND VERTICAL OPERATION FOR PIPES, PROFILES AND BARS



Shaft diameter	30 mm
Upper roller diameter	98 mm
Lower rollers diameter	98 mm
Round speed	4.8 ÷ 7.2 m/min
Three-phase motor	400 V 50 Hz 1,1 kW
Dimensions	620 x 1100 x 1360 mm
Net weight	230 kg
Packing dimensions	1140 X 680 X 1250 mm
Weight	251 kg

C022/100

CAT. 42 € 2060,00

ROLL FORMING MACHINE

WITH 3 ROLLERS

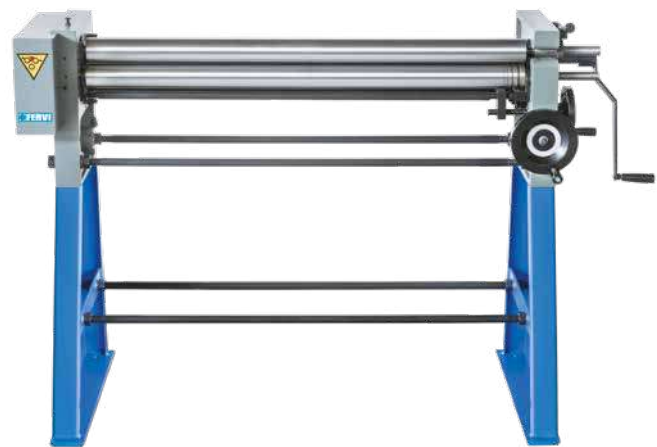

Max rolling length	1000 mm
Max thickness	2 mm
Roller diameter	60 mm
Net weight	200 kg
Weight	240 kg
Packing dimensions	1450 x 600 x 600 mm



0776

€ 943,00

ROLL FORMING MACHINE

WITH 3 ROLLERS



Max rolling length	1000 mm
Max thickness	0,8 mm
Roller diameter	50 mm
Weight	130 kg

0668

€ 1120,00

FORGING FURNACE

EASY TO USE, QUICK IGNITION, NO INJURIOUS EMISSIONS, REAR DOOR TO HEAT THE IRON BAR CENTER. ISOLATION CHAMBER IN FIBRECERAMICS. REGULATOR, NON-RETURN VALVE AND THERMOCOUPLE EQUIPPED



Working temperature	1300° C ÷ 1400° C
Max working capacity	Ø 70 mm / ■ 50 mm
Power	G.P.L.
Consumption	0,05 - 1,5 kg / h
Internal dimensions	280 x 210 x 100h mm
External Dimensions	400 x 260 x 250h mm
Weight	20 kg

0773-

HAND SHEAR

0773/05L

€ 68,80

BLADE SET



0773/10L

€ 90,00

BLADE SET



Art.	€	Overall sizes	Base dimensions	Handle length	Blade length	Flat bar	Plate thicknesser	Round	Weight
0773/05	€ 138,00	290 x 120 x 240 mm	290 x 90 mm	620 mm	130 mm	38x3mm	0,5 ÷ 3 mm	Ø6 mm	10 kg
0773/10	€ 201,00	420 x 120 x 390 mm	420 x 90 mm	800 mm	250 mm	70x3mm	0,5 ÷ 3 mm	Ø6 mm	23 kg



0197

€ 473,00

UNIVERSAL BENDER



Round bar	15 mm
Flat bar	30 x 8 mm
Square	13 mm
Looped bending Max	8 x 30 mm A caldo / Hot
Weight	22 kg

0102

€ 276,00

IRON BENDER

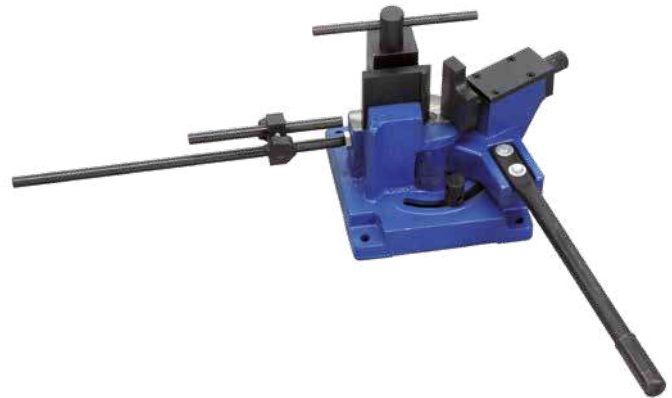

Iron	Cold
Round bar	22 mm
Flat bar	100 x 8 mm
Square	20 mm
Weight	30 kg

0113

€ 268,00

SPIRAL BENDER



Iron	Cold
Round bar	10 mm
Flat bar	10 x 30 mm
Square	10 mm
Weight	27 kg

0893

€ 445,00

HYDRAULIC TUBE BENDER

1 1/2 - 2"

WITH 2 SPEEDS PUMP

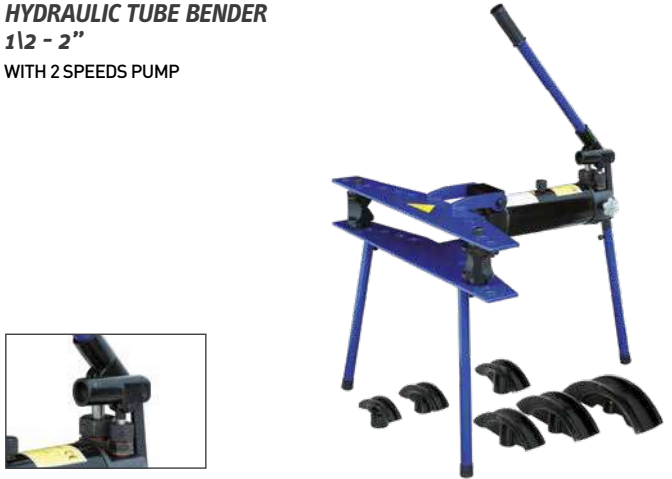

Dies	1/2" 3/4" 1" 1-1/4" 1-1/2" 2" gas
Capacity	10 tons N
Ram stroke	250 mm
Weight	48 kg

0292-

COPPER TUBE BENDER



Art.	€	Sizes
0292	€ 13,50	ø 8 - 10 - 12 mm
0292/14	€ 12,90	ø 14 mm
0292/16	€ 14,60	ø 16 mm



0796

€ 2680,00

WOOD LATHE WITH COPY DEVICE

WITH DRIVE BELT

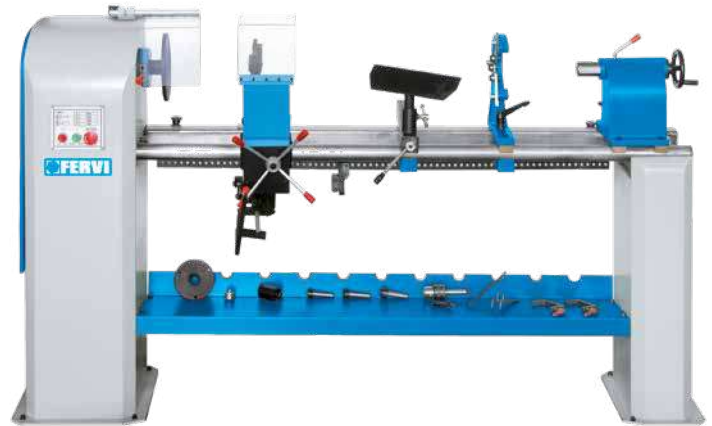

Distance between centers	1300 mm
Centers height	210 mm
Spindle nose Camlock	M 33x3,5 DIN800
Flange chuck	Ø 125 mm
Tailstock	CM / MT 2
Single-phase motor	230 V 50 Hz 1,5 kW
Approx spindle speeds	500 - 1000 - 1950 - 2800 rpm
Overall sizes	2100 x 400 x 1200h mm
Weight	253 kg



0758

€ 1020,00

WOOD LATHE

WITH ROTATING HEAD, VARIABLE SPEED DRIVE BELT AND CAST IRON BENCH



Max length of workpiece	1100 mm
Centers height	185 mm
Single-phase motor	230 V 50 Hz 0,75 kW
Approx spindle speeds	500 ÷ 2000 rpm
Thread	1" - 8 TPI
Tailstock	CM 2
Weight	130 kg



0751

€ 678,00

WOOD LATHE

WITH ROTATING HEAD, VARIABLE SPEED DRIVE BELT AND STEEL SHEET BENCH



Max length of workpiece	900 mm
Centers height	155 mm
Single-phase motor	230 V 50 Hz 0,37 kW
Speeds	500 ÷ 2000 rpm
Thread	1" - 8 TPI
Tailstock	CM 2
Weight	80 kg



0758/C

€ 296,00

COPY DEVICE FOR WOOD LATHE

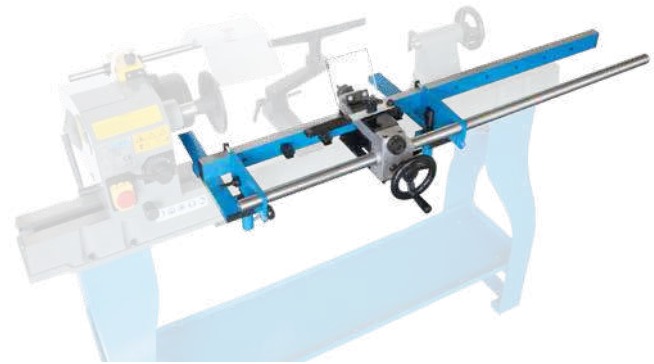

Max length of workpiece	1000 mm
Weight	18 kg

0648

CAT. 42 € 800,00

WOOD LATHE

WITH COPY DEVICE

Max length of workpiece	1000 mm
Thread	1" - 8 TPI
Centers height	175 mm
Single-phase motor	230 V 50 Hz 0,75 kW
Speeds	500 ÷ 2000 rpm
Tailstock taper MT	2
Net weight	72 kg
Dimensions	1400 x 500 x 1300h mm
Packing dimensions	1480 x 380 x 460 mm
Weight	76 kg



0497-

10" WOOD LATHE

WITH BELT SPEED CHANGE



Art.	€	Max length of workpiece	Centers height	Single-phase motor	Approx spindle speeds	Weight
0497/250	€ 494,00	457 mm	125 mm	230 V 50 Hz 0.37 kW	(5) 700 - 3000 rpm	33 kg
0497/300	€ 549,00	457 mm	150 mm	230 V 50 Hz 0.55 kW	(5) 700 - 3000 rpm	38 kg



0425-

4 JAW SELF-CENTERING CHUCK

FOR WOOD LATHE

Worm screw



Art.	€	Ø	Clamp capacity	Clamp capacity	Thread	Weight
0425/100	€ 161,00	95 mm	Int. 32 - 45 mm	Ext. 68 - 85 mm	1" - 8 TPI	2,24 kg
0425/125	€ 183,00	125 mm	Int. 50 - 70 mm	Ext. 85 - 110 mm	1" - 8 TPI e M33 x 3,5	4,54 kg

0751/P

CHUCK FOR LATHE

€ 55,00



4 jaw independent reversible chuck	Ø 150 mm
Thread	1" - 8 TPI
Hole	Ø 22 mm
Weight	2,5 kg

0751/A4

CHUCK FOR LATHE

€ 103,00



4 jaw reversible self centering chuck	Ø 125 mm
Thread	1" - 8 TPI
Hole	Ø 22 mm
Weight	2 kg

COMPATIBILITY CHART

Art.	€	0796	0758	0751	0648	0497/250	0497/300	PAG
0758/C	296,00		•	•				77
0425/100	161,00		•	•	•	•	•	78
0425/125	183,00	•	•	•	•	•	•	78
0751/A4	103,00		•	•	•	•	•	78
0751/P	55,00		•	•	•	•	•	78
0162	14,80	•	•	•	•	•	•	384
0306	50,40	•	•	•	•	•	•	384
0168	8,80	•	•	•	•	•	•	384
0300	15,00	•	•	•	•	•	•	384
0301/06-10-16-20-24	-	•	•	•	•	•	•	-
C028/150-200-250-300	-	•	•	•	•	•	•	-
C029/150-200-250-300	-	•	•	•	•	•	•	-
0087	35,60	•	•	•	•	•	•	231
0087/35	9,00	•	•	•	•	•	•	231
A001/2/12	7,60	•	•	•	•	•	•	156
A001/2/16	8,60	•	•	•	•	•	•	156
A001/2/18	8,90	•	•	•	•	•	•	156
M051/10	46,70	•	•	•	•	•	•	157
M051/13	54,80	•	•	•	•	•	•	157
M051/16	66,10	•	•	•	•	•	•	157
M049/125	169,00	•						158
M449/125	195,00	•						158



0498

€ 7470,00

8 FUNCTIONS COMBINE MACHINE

BENCH SAW, SLIDING CARRIAGE, SCORING BLADE, SPINDLE MOULDER, SURFACE PLANNER, THICKNESS PLANNER, MORTISING UNIT AND SANDING DRUM AT 1500 RPM



Overall dimensions	1880 x 1500 x 1050 mm
Tables height	840 mm
Single-phase motor	3 x 230 V 50 Hz 2.2 kW
Weight	445 kg
Packing dimensions	1600 x 1300 x 1010 mm



BENCH SAW

Main table dimensions	1045 x 800 mm
Blade dimensions	254 x 3,2 x 30 mm 24 Z
Blade speed	4050 rpm
Cut height	65 mm 90° - 45 mm 45°



PLANER THICKNESSER

Table dimensions	1285 x 310 mm
Arbor size	ø 75 mm
Inlet size	ø 100 mm
Knives	3
Planer capacity	310 x 5 mm
Thickness capacity	310 x 180 mm
Cutter arbor speed	4000 rpm



SLIDING CARRIAGE

Max cutting length with saw bench	1370 mm
Sliding table	1500 x 840 mm

SCORING BLADE

Blade dimensions	ø 80 x 3,2 x 20 mm 8 Z
Blade speed	6300 rpm



MORTISER

Table dimensions	150 x 365 mm
Vertical stroke	0 ÷ 80 mm
Longitudinal travel	0 ÷ 85 mm
Cross travel	0 ÷ 140 mm
Cutter arbor speed	4000 rpm



SPINDLE MOULDER

Arbor size	ø 30 mm
Spindle travel	130 mm
Cutter arbor speed	1500 / 4000 / 6000 rpm



SANDING DRUM

Dimensions	ø 100 x 100h mm
Spindle speed	1500 rpm



0499

€ 2230,00

12" PLANER & THICKNESSER

WITH MORTISE OPTION

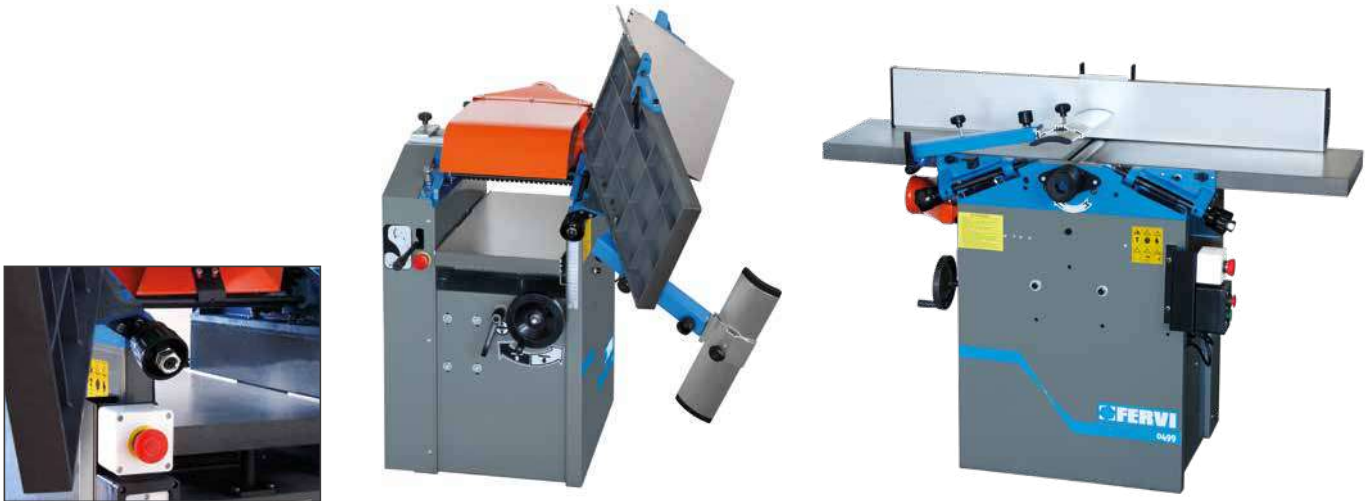

Overall dimensions	1290 x 550 x 1000 mm
Tables height	810 mm
Table dimensions	310 x 1285 mm
Arbor size	ø 75 mm
Knives	3

0749

€ 1660,00

COMBINED PLANER AND THICKNESSER

WITH CAST IRON TABLES

Knife for planer (Art. 0749/C)



Overall sizes	1050 x 485 x 800h mm
Tables height	810 mm
Table dimensions	1050 x 250 mm
Arbor	ø 75 mm
Blades	N° 3
Planer capacity	250 x 2 mm
Thickness capacity	250 x 1,2 180h mm
Cutter arbor speed	4000 rpm
Single-phase motor	230 V - 50Hz - 1,5 kW
Weight	164 kg

0517A

CAT. 42 € 692,00

THICKNESSER

CAPACITY 13", WITH WORKING PLATE MADE OF GRANITE

Dimensions	610 x 600 x 470 mm
Table dimensions	330 x 238 mm
Arbor	ø 51.5 mm
Blades	2
Thickness capacity	330 x 2.4 x 152 mm
Cutter arbor speed	8500 rpm
Single-phase motor	230 V 50 Hz 1.5 kW
Net weight	35 kg
Packing dimensions	660 x 390 x 490 mm
Weight	38 kg



0686/200

€ 472,00

COMBINED PLANER AND THICKNESSER

WITH ALUMINUM WORKING TABLES

Knife for planer (Art. 0686/200C)

Overall sizes	770 x 430 x 450h mm
Tables height	360 mm
Table dimensions	737 x 210 mm
Arbor	Ø 50 mm
Knives	N° 2
Planer capacity	204 x 2 mm
Thickness capacity	204 x 2 x 120h mm
Cutter arbor speed	8000 rpm
Single-phase motor	230 V 50 Hz 1,25 kW
Weight	27 kg



0749/M

€ 375,00

MORTISING MACHINE

WITH CAST IRON WORKING TABLES



Chuck sizes	Ø 16 mm
Table dimensions	370 x 150 mm
Vertical stroke	0 - 80 mm
Lateral stroke	0 - 140 mm
Weight	26 kg

0749/MC

€ 102,00

WESTCOTT CHUCK

Capacity	16 mm
Female junction	M20 x 1,5 Sx / Left
Sizes	Ø 55 x 68,5 mm



M057/16

€ 104,00

"WESTCOTT" CHUCK

Capacity	16 mm
Female junction	B18
Sizes	Ø 60 x 65 mm



0697

€ 45,80

2-PC SET MAGNETIC QUICK PLANER KNIFE SETTING JIG

2 Pcs

For planer blade with cutter arbor	Ø 75 ÷ 125 mm
Weight	0,4 kg

0684

€ 20,80

SCORING BLADE WITH CARBIDE TIPPED TEETH

WITH ALTERNATE UNIVERSAL TEETH TO AVOID TEAROUT DURING CUTTING

Ø	80 mm
Teeth Z	8
Hole	Ø 20 mm
Cut thickness	3.2 mm
Blade thickness	2.2 mm
rpm max	4050 rpm



0499/C

€ 67,00

3 PC KNIVES SET

FOR PLANER AND THICKNESSER



3 Pcs

Sizes	310 x 30 x 3 mm
-------	-----------------

0749/C

€ 51,90

3 PC KNIVES SET

FOR PLANER AND THICKNESSER



3 Pcs

Sizes	250 x 30 x 3 mm
-------	-----------------



0517/59

€ 48,90

KNIFE SET FOR THICKNESS
12.5"



2 Pcs

Knives 2 - 320 x 12 x 1.5 mm

0686/200C

€ 30,80

2 PC KNIVES SET
FOR PLANER AND THICKNESSER



2 Pcs

Sizes 210 X 22 X 2 mm

COMPATIBILITY CHART

Art.	€	0498	0499	0749	0517A	0686/200	PAG
0686/200C	30,80					•	82
0499/C	67,00	•	•				81
0749/C	51,90			•			81
0749/M	375,00	•	•	•			81
0749/MC	102,00	•	•	•			81
0697	45,80	•	•	•			81
0799/SX	-	•	•	•			-
0559/T	127,00	•					-
0684	20,80	•					81
0702	41,80	•					258
0703	48,20	•					258
0507	236,00				•	•	94
0756	319,00			•	•	•	94
0759	533,00	•	•	•			94
0496	618,00	•	•	•			94
0756/T	32,40	•	•	•	•		95
0507/07	20,80	•	•	•	•		95
0507/4R	6,70	•	•	•	•	•	95
A040/30A	148,00				•	•	109
A040/60A	240,00				•	•	109
A024/602	233,00				•	•	110
R001/04	275,00	•					61
R001/07	386,00	•					61

0559

€ 1240,00

2 IN 1 SPINDLE MOULDER AND SPINDLE SANDER



Speed change box with microswitch



Control panel



Toupie knife adapters



Sliding table

0559/T € 127,00

SANDING DRUM

Single-phase motor	230V 50Hz 1,5kW
Spindle speed	1500 / 4000 / 6000 rpm
Spindle diameter	30 mm
Spindle travel	105 mm
Table well diameter	160 mm
Cast iron working tables	600 x 400 mm
Cast iron sliding carriage	400 x 250 mm
Sliding carriage guide	700 mm
Tables height	850 mm
Dimensions	74 x 66 x 98 cm
Weight	116 kg

0504

€ 4720,00

PANEL SAW MOULDER

BENCH SAW, SLIDING CARRIAGE, SCORING BLADE, SPINDLE MOULDER, AND SANDING DRUM AT 1500 RPM

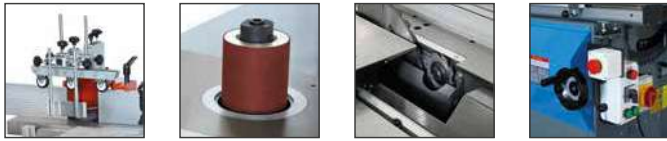

Tables height	840 mm
Overall dimensions	1670 x 1200 x 1050 mm
BENCH SAW	
Main table dimensions	1045 x 800 mm
Blade dimensions	ø 254 x 3.2 x 30 mm 24 Z
Blade speed	4050 rpm
Cut height	65 mm 90° - 45 mm 45°
SLIDING CARRIAGE	
Max cutting length with saw bench	1070 mm
Sliding table	1200 x 840 mm
SCORING BLADE	
Blade dimensions	ø 80 x 3.2 x 20 mm 8 Z
Blade speed	6300 rpm

SPINDLE MOULDER

Arbor size	ø 30 mm
Spindle travel	130 mm
Spindle speed	1500 / 4000 / 6000 rpm
SANDING DRUM	
Dimensions	ø 100 x 100h mm
Spindle speed	1500 rpm
Single-phase motor	2 x 230 V 50 Hz 2.2 kW
Weight	230 kg
Packing dimensions	1300 x 930 x 1010 mm



0665

€ 2580,00

PARTIALLY ASSEMBLED PANEL SAW

Blade	250 x 3 x 30 mm Z 40
Blade speed	2800 rpm
Main table dimensions	800 x 560 mm
Extension table dimensions	800 x 305 mm
Working height	860 mm
Max cut depth at 45°	60 mm
Max cut depth at 90°	75 mm
Sliding table	500 x 600 mm
Overall dimensions	1860 x 2030 x 1070h mm
Single-phase motor	230 V 50 Hz 2,2 kW
Max cutting length with saw bench	1460 mm
Weight	243 kg



0656/254

CAT. 42 € 2150,00

PANEL SAW

CAPACITY 254 mm, PARTIALLY ASSEMBLED

Blade sizes	254 x 30 x 3,2 mm 40 T
Blade speed	4000 rpm
Main table dimensions	790 x 350 mm
Extension table dimensions	350 x 350 mm
Working height	850 mm
Cutting depth at 90°	80 mm
Cutting depth at 45°	56 mm
Sliding table	1320 x 238 mm
Single-phase motor	230 V 50 Hz 2,2 kW
Max cutting length with saw bench	1250 mm
Net weight	150 kg
Weight	185 kg



0656/310

CAT. 42 € 2480,00

PANEL SAW

CAPACITY 315 mm, PARTIALLY ASSEMBLED



Blade sizes	315 x 30 x 3,2 mm 40 T
Blade speed	4000 rpm
Main table dimensions	790 x 350 mm
Extension table dimensions	350 x 350 mm
Working height	850 mm
Cutting depth at 90°	100 mm
Cutting depth at 45°	70 mm
Sliding table	1320 x 238 mm
Single-phase motor	230 V 50 Hz 2,2 kW
Max cutting length with saw bench	1400 mm
Net weight	175 kg
Weight	215 kg

0280

€ 793,00

CIRCULAR SAW BENCH EQUIPPED WITH CARBIDE TIPPED SAW BLADE



Table dimensions	800 x 550 mm
Table extension	800 x 550 mm
Working height	810 mm
Cutting depth at 90°	90 mm ca.
Cutting depth at 45°	50 mm ca.
Blade dimensions	315 x 3 x 30 mm Z 36
Tilting saw blade	45°
Sliding carriage	1160 mm
Sliding carriage dim.	230 x 230 mm
Motor speed	2800 rpm
Single-phase motor	230 V 50 Hz 2,2 kW
Weight	63 kg

0871

€ 492,00

SLIDE COMPOUND MITRE SAW

WITH LASER BEAM INDICATOR OF THE CUTTING LINE



Saw blade	Ø 305 x 30 x 3,2 mm Z 40
Max cutting capacity 0° - 90°	340 x 100 mm
Max cutting capacity 45° - 90°	240 x 100 mm
Sliding travel	215 mm
Single-phase motor	230 V 50 Hz 2 kW
Motor speed	4500 rpm
Weight	25 kg

0870/250

€ 347,00

MITRE SAW

WITH UPPER TABLE FOR USAGE AS SAW BENCH



Saw blade	Ø 250 x 30 x 2,5 mm Z 36
Max cutting capacity 0° - 90°	75 x 130 mm
Max cutting capacity 45° - 45°	75 x 50 mm
Max cutting capacity 45° - 90°	75 x 90 mm
Max cutting capacity 0° - 45°	50 x 130 mm
Max cutting capacity, upper table	40 mm
Single-phase motor	230 V 50 Hz 1,8 kW
Motor speed	4500 rpm
Weight	18 kg

0365

€ 199,00

PORTABLE UNIVERSAL MITRE SAW STAND

FOLDABLE



Working height	860 mm
Extension height	950 ÷ 1100 mm
Stand length	1200 mm
Extensions height operation length	1350 ÷ 3000 mm
Clamp size	500 x 35 mm
Overall sizes	1300 x 230 x 950h mm
Weight	18 kg



COMPATIBILITY CHART

Art.	€	0559	0504	0656/310	0656/254	0665	0280	0871	0870/250	PAG
0559/T	127,00	•	•							82
A024/602	233,00	•	•	•	•	•	•	•	•	110
A040/30A	148,00	•	•	•	•	•	•	•	•	109
A040/60A	240,00	•	•	•	•	•	•	•	•	109
0365	199,00							•	•	85
0522	206,00								•	61
R001/04	275,00	•	•	•	•	•				61
R001/07	386,00	•	•	•	•	•				61
0495	318,00	•	•	•	•	•	•			94
0507	236,00	•	•	•	•	•	•			94
0756	319,00	•	•	•	•	•	•			94
0759	533,00	•	•	•	•	•	•			94
0496	618,00	•	•	•	•	•	•			94
0756/T	32,40	•	•	•	•	•	•			95
0507/07	20,80	•	•	•	•	•	•			95
0507/4R	6,70	•	•	•	•	•	•	•	•	95
0684	20,80		•	•	•					81
0702	41,80		•	•	•	•			•	258
0703	48,20		•	•	•	•			•	258
0685	25,00		•	•	•				•	258
0704	61,90			•			•	•		258
0705	66,80			•			•	•		258
0899	46,20						•	•		258

WOOD BAND SAW



Cutting capacity (mm)

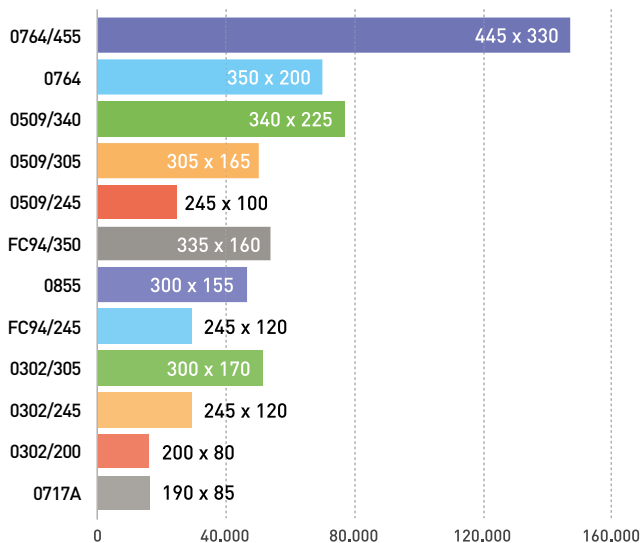

Power (kW)

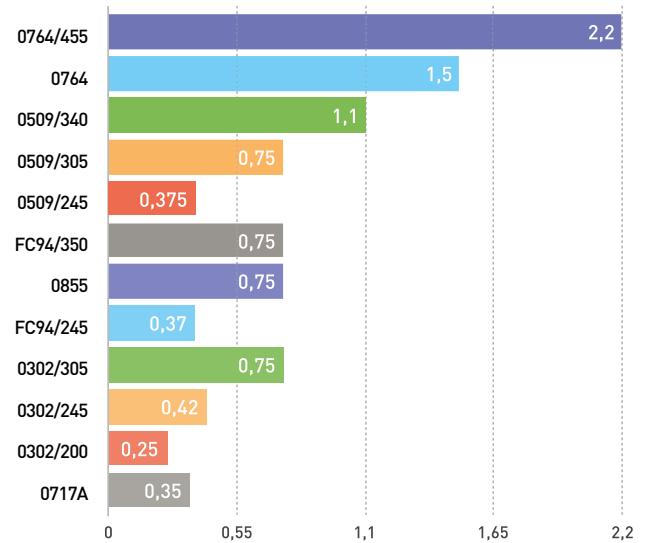

0764/455

€ 2010,00

WOOD BAND SAW



Saw wheel	Ø 455 mm
Cutting capacity	445 x 330h mm
Blades	3430 x 20 x 0,65 mm T4
Table dimensions	500 x 600 x 40h mm
Cutting speed	10 m/s
Tilting table	0 ÷ 20°
Working height	950 mm
Overall sizes	1000 x 900 x 1860h mm
Single-phase motor	230 V 50 Hz 2,2 kW
Weight	216 kg

0764

€ 1350,00

WOOD BAND SAW



Saw wheel	Ø 405 mm
Cutting capacity	350 x 200h mm
Blades	2950 x 16 x 0,65 mm T4
Table dimensions	500 x 395 x 32h mm
Cutting speed	10 m/s
Tilting table	0 ÷ 20°
Working height	995 mm
Overall sizes	750 x 650 x 1710h mm
Single-phase motor	230 V 50 Hz 1,5 kW
Weight	136 kg



0509/340

€ 1140,00

WOOD BAND SAW

WITH ACCESSORY FOR CIRCULAR CUTTING, LED LAMP AND SAWDUST COLLECTOR DRAWER



Saw wheel	ø 347 mm
Cutting capacity	340 x 225 mm
Blades	2560 x 12.7 x 0.5 mm T4
Table dimensions	545 x 400 mm
Cutting speed	6-12 m/s
Tilting table	0-45°
Working height	1010 mm
Dimensions	900 x 670 x 1720 mm
Single-phase motor	230V 50Hz 1.1kW
Weight	70 kg



0509/305

€ 987,00

WOOD BAND SAW

WITH ACCESSORY FOR CIRCULAR CUTTING, LED LAMP AND SAWDUST COLLECTOR DRAWER



Saw wheel	ø 314 mm
Cutting capacity	305 x 165 mm
Blades	2240 x 12.7 x 0.5 mm T4
Table dimensions	480 x 390 mm
Cutting speed	6-12 m/s
Tilting table	0-45°
Working height	990 mm
Dimensions	700 x 600 x 1585 mm
Single-phase motor	230V 50Hz 0.750kW
Weight	62 kg



0509/245

€ 644,00

WOOD BAND SAW

WITH ACCESSORY FOR CIRCULAR CUTTING, LED LAMP AND SAWDUST COLLECTOR DRAWER



Saw wheel	ø 254 mm
Cutting capacity	245 x 100 mm
Blades	1826 x 10 x 0.35 mm T6
Table dimensions	360 x 320 mm
Cutting speed	6.7 - 13.3 m/s
Tilting table	0-45°
Working height	925 mm
Dimensions	750 x 480 x 1420 mm
Single-phase motor	230V 50Hz 0.375kW
Weight	37 kg



FC94/350

€ 1000,00

14" WOOD BAND SAW

Saw wheel	ø 350 mm
Cutting capacity	335 x 160 mm
Blades	2400 x 13 x 0.52 mm 4T
Table dimensions	500 x 400 mm
Cutting speed	10 - 12 m/s
Tilting table	0° - 45°
Working height	1015 mm
Overall sizes	730 x 620 x 1540 mm
Single-phase motor	230 V 50 Hz 0.75 kW
Weight	82 kg

0855

€ 819,00

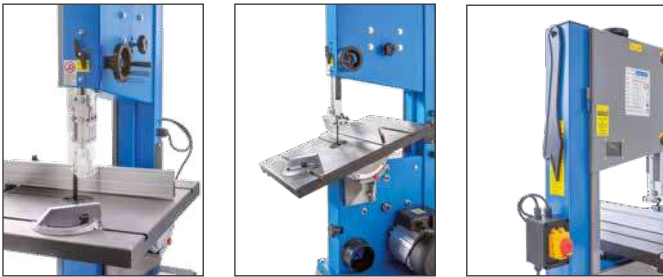
WOOD BAND SAW

Saw wheel	Ø 315 mm
Blade	2240 x 16 x 0,52 mm T4
Cutting capacity	300 x 155h mm
Table dimensions	400 x 500 mm
Cutting speed	6 - 12 m/s 370 - 800 rpm
Tilting table	0 ÷ 20°
Working height	1010 mm
Overall sizes	650 x 650 x 1610h mm
Single-phase motor	230 V 50 Hz 0,75 kW
Weight	79 kg

**FC94/245**

€ 502,00

10" WOOD BAND SAW

Saw wheel	ø 255 mm
Cutting capacity	245 x 120 mm
Blades	1790 x 8.4 x 0.35 mm 6T
Table dimensions	340 x 340 mm
Cutting speed	11 - 16 m/s
Tilting table	0° - 45°
Working height	1000 mm
Overall sizes	420 x 250 x 800 mm
Single-phase motor	230 V 50 Hz 0.37 kW
Weight	29 kg



0302/305
€ 622,00
WOOD BAND SAW
 WITH ALUMINIUM TABLE

Saw wheel	ø 315 mm
Cutting capacity	300 x 170 mm
Blades	2240 x 11 x 0.8 mm T6
Table dimensions	500 x 400 mm
Cutting speed	6 ÷ 12 m/s
Tilting table	0° ÷ 45°
Working height	960 mm
Dimensions	80 x 500 x 1580 mm
Single-phase motor	230 V 50 Hz 0.75 kW
Weight	58 kg

0302/245
€ 408,00
WOOD BAND SAW
 WITH ALUMINIUM TABLE

Saw wheel	ø 255 mm
Cutting capacity	245 x 120 mm
Blades	1790 x 9 x 0.5 mm T6
Table dimensions	290 x 290 mm
Cutting speed	11 ÷ 16 m/s
Tilting table	0° ÷ 45°
Working height	1000 mm
Overall sizes	600 x 400 x 1480 mm
Single-phase motor	230 V 50 Hz 0.42 kW
Weight	30 kg

0302/200
€ 279,00
WOOD BAND SAW
 WITH STEEL TABLE

Saw wheel	ø 210 mm
Cutting capacity	200 x 80h mm
Blade	1400 x 6 x 0,36 mm T6
Table dimensions	300 x 300 mm
Cutting speed	15 m/s
Tilting table	0 ÷ 45°
Overall sizes	450 x 390 x 680h mm
Single-phase motor	230 V 50 Hz 0.25 kW
Weight	17 kg

0717A
€ 266,00
WOOD BAND SAW

Saw wheel	ø 200 mm
Blade	1430 x 6 x 0,36 mm T6
Cutting capacity	190 x 80h mm
Table dimensions	290 x 290 mm
Cutting speed	13,7 m/s
Tilting table	0 ÷ 45°
Overall sizes	430 x 355 x 665h mm
Single-phase motor	230 V 50 Hz 0,35 kW
Weight	19 kg



COMPATIBILITY CHART

Art.	€	0764/455	0764	0509/340	0509/305	0509/245	FC94/350	0855	FC94/245	0302/305	0302/245	0302/200	0717A	PAG
N717/N	19,70													• 258
N717/N1	19,70													• 258
N186	20,00						•							258
N187	20,00						•							258
N188	23,30							•		•				258
N189	23,30							•		•				258
N190	23,30					•								258
N191	23,30					•								258
N192	20,00		•											258
N193	20,00		•											258
N194	19,70											•		258
N195	19,70											•		258
N855/N	22,40			•			•		•					258
N855/N2	22,40			•			•		•					258
N764/N	22,40	•												258

Art.	€	0764/455	0764	0509/340	0509/305	0509/245	FC94/350	0855	FC94/245	0302/305	0302/245	0302/200	0717A	PAG
N764/N2	22,40		•											258
N764/455/N	31,10	•												258
N764/455/N2	31,10	•												258
0507	236,00	•	•	•	•	•	•	•	•	•	•	•		94
0495	318,00	•	•	•	•	•	•	•	•	•	•	•		94
0496	618,00	•	•	•	•	•	•	•	•	•	•	•		94
0759	533,00	•	•	•	•	•	•	•	•	•	•	•		94
0756	319,00	•	•	•	•	•	•	•	•	•	•	•		94
0756/T	32,40	•	•	•	•	•	•	•	•	•	•	•		95
0507/07	20,80	•	•	•	•	•	•	•	•	•	•	•		95
0507/4R	6,70	•	•	•	•	•	•	•	•	•	•	•	•	95
A040/30A	148,00								•		•	•	•	109
A040/60A	240,00								•		•	•	•	109
A024/602	233,00								•		•	•	•	110
A024/10	56,70								•		•	•	•	109



0523

€ 340,00

TILTING BELT DISC SANDER



Suction nozzle



Side sanding disc



Idler roller with bearing

Dimensions	530 x 430 x 330 mm
Belt	914 x 100 mm
Disc diameter	ø 150 mm
Single-phase motor	230V 50Hz 0.375kW 1850rpm
Weight	20 kg



0505

€ 227,00

TILTING BENCH BELT SANDER



Vertical work



Side sanding disc



Idler roller with bearing

Overall sizes	460 x 380 x 270h mm
Belt	914 x 100 mm
Disc diameter	ø 150 mm
Single-phase motor	230V 50 Hz 0,5 kW 2850 rpm
Weight	18 kg





0138

€ 472,00

BELT AND DISC SANDER

WITH TILTING TABLES



Feed table

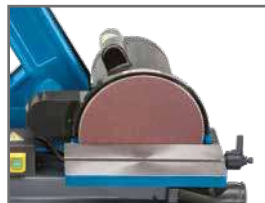

Side sanding disc

Overall sizes	630 x 370 x 495h mm
Belt	25 x 1075 mm
Belt speed	8.5 m/s
Disc diameter	200 mm
Single-phase motor	230 V 50 Hz 0,45 kW 1450 rpm
Weight	26 kg

0765

€ 208,00

SCROLL SAW VARIABLE SPEED

WITH LED LAMP. STRONG BODY, TILTING TABLE, SUITABLE TO CUT Balsa AND PLYWOOD



0753/A

€ 11,30

BLADE ADAPTER

0753/L

€ 3,91

BLADES SET

Cutting capacity	400 x 50h mm
Blade length	127 mm
Oscillations	800 ÷ 1400 rpm
Table dimensions	410 x 250 mm
Tilting table	0 ÷ 45° sx
Base dimensions	230 x 390 mm
Single-phase motor	230 V 50 Hz 0,12 kW
Weight	14,5 kg

0144

€ 375,00

SCROLL SAW VARIABLE SPEED

WITH LED LAMP. STRONG BODY, TILTING TABLE, SUITABLE TO CUT Balsa, PLYWOOD, SOFT WOODS, PLASTIC AND NO FERROUS METAL



Cutting capacity	457 x 50h mm
Blade length	127 mm
Oscillations	550 ÷ 1650 rpm
Table dimensions	480 x 250 mm
Tilting table	0 ÷ 45° sx
Base dimensions	220 x 420 mm
Single-phase motor	230 V 50 Hz 0,12 kW
Weight	20 kg

0720

€ 46,90

PRECISION MITRE SAW



0720/L

€ 7,30

BLADE

Cut height	110 mm
Cut width	120 mm
Cutting tilting	0° ±45°
Base	400 x 80 mm
Blade sizes	550 x 45 mm
Weight	4,1 kg

S009

€ 1170,00

VERTICAL HEAVY DUTY LOG SPLITTER

7 TON, WITH CROSS LOG SPLITTER



Height working capacity	1040 / 780 / 520 mm
Log capacity	ø 50 ÷ 320 mm
Max splitting force	7 ton
Single-phase motor	230 V 50 Hz 3 kW
No-load speed	2950 rpm
Weight	123 kg
Packing dimensions	575 x 635 x 1110h mm

S015

€ 94,40

MANUAL LOG SPLITTER

FOOT OPERATED, TO SPLIT LOGS INTO SMALL PARTS TO LIGHT FIRE

Log capacity	ø 254 x 460 mm
Max splitting force	1,2 ton
Blade dimensions	100 x 80h mm
Weight	8,6 kg





0496

€ 618,00

DUST COLLECTOR



Overall sizes	1450 x 800 x 2000 mm
Inlet size	3 x ϕ 100 mm
Air flow	3900 m ³ / h
Single-phase motor	230 V 50 Hz 2.2 kW
Cloth bag	ϕ 510 mm x 855h mm
Weight	50 kg

0759

€ 533,00

PARTIALLY ASSEMBLED DUST COLLECTOR



Overall sizes	840 x 560 x 1800h mm
Inlet size	2 x diam. 100 mm
Filtration rate	5 micron
Air flow	2500 m ³ / h
Single-phase motor	230 V 50 Hz 1,5 kW
Motor speed	2950 rpm
Cloth bag	ϕ 510 mm
Vacuum suction	1,95 kPa
Weight	44 kg

0756

€ 319,00

**DUST COLLECTOR
PARTIALLY ASSEMBLED**



Overall sizes	500 x 600 x 1700h mm
Inlet size	100 mm
Cloth bag	ϕ 370 mm
Filtration rate	5 micron
Air flow	850 m ³ / h
Single-phase motor	230 V 50 Hz 0,75 kW
Motor speed	2950 rpm
Vacuum suction	1,08 kPa
Weight	25 kg

0507

CAT. 42 € 236,00

**DUST COLLECTOR
PARTIALLY ASSEMBLED**



Overall sizes	500 x 600 x 1700h mm
Inlet size	100 mm
Cloth bag	ϕ 320 mm
Filtration rate	5 micron
Air flow	900 m ³ / h
Single-phase motor	230 V 50 Hz 0,55 kW
Motor speed	2840 rpm
Vacuum suction	0,70 kPa
Gross weight	28 kg

0495

€ 318,00

PORTABLE DUST COLLECTOR

WITH WHEELS FOR WOOD BAND SAW AND MITRE SAW



Overall sizes	395 x 325 x 350 mm
Inlet size	1 x ϕ 100 mm
Air flow	830 m ³ / h
Single-phase motor	230 V 50 Hz 0.75 kW
Cloth bag	ϕ 380 mm x 530h mm
Weight	22 kg

0759/F

€ 23,20

FILTER BAG



Dimensions ϕ 510 mm x 855h mm

0759/S

€ 42,70

PLASTIC BAG SET



10 Pcs

Dimensions ϕ 510 mm x 855h mm



0756/F

€ 18,70

FILTER BAG



Dimensions ϕ 370 mm x 590h mm

0756/S

€ 35,20

PLASTIC BAG SET



10 Pcs

Dimensions ϕ 370 mm x 590h mm

0756/T

€ 32,40

**PLASTIC HOSE FITTING
WITH METAL CORE**



Max length 2 m
Diameter 100 mm

0756/Y

€ 15,90

Y FITTING



Diameter 100 mm

0507/14

CAT. 42 € 18,90

PLASTIC BAG SET



10 Pcs

Dimensions ϕ 330 mm x 500h mm

0507/15

CAT. 42 € 35,00

FILTER BAG



Dimensions ϕ 320 mm x 590h mm

0507/07

CAT. 42 € 20,80

**PLASTIC HOSE FITTING
WITH METAL CORE**



Length 2 m
Diameter 100 mm

0507/4R

CAT. 42 € 6,70

FITTING WITH 4 DIAMETERS

REDUCTION FROM HOSE OF 100 mm TO:
70 mm 50 mm 40 mm 35 mm



Diameter 100 mm

0495/24

€ 15,00

FILTER BAG





SANDERS



Internal dimensions (mm)

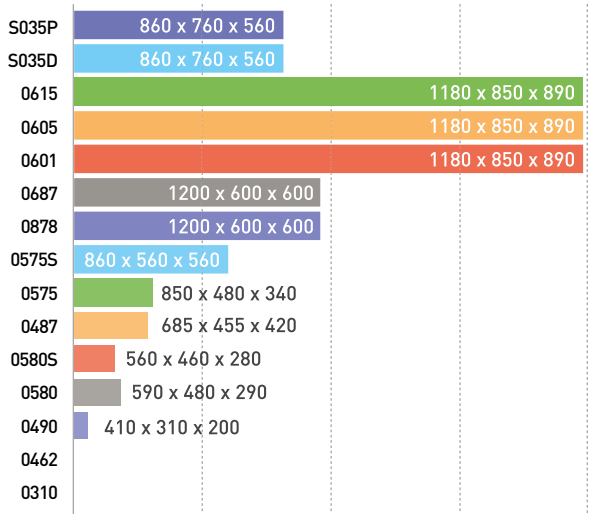

Air consumption (l/min)

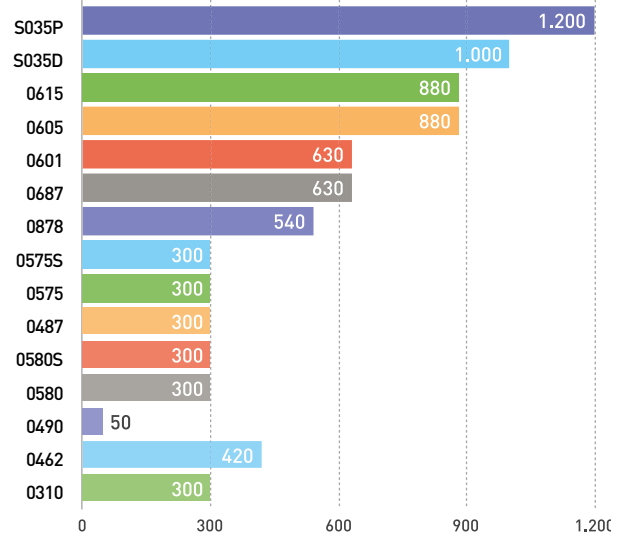

S035P

CAT. 42 € 9080,00

PRESSURE SANDBLAST CABINET

WITH CYCLONE VACUUM CLEANER, HEPA FILTER, SIDE OPENING, TROLLEY WITH ROTARY TABLE



Working area	890 x 790 x 600
Working pressure	5 ÷ 7 bar
Air consumption	1600 ÷ 2200 lit/min
Gun nozzle	8 mm

Max power	400 V 50 Hz 2,25 kW
Filtration rate	99% 5 micron
Weight	600 kg

S035D

CAT. 42 € 5750,00

VACUUM SANDBLAST CABINET

WITH CYCLONE VACUUM CLEANER, HEPA FILTER, SIDE OPENING, TROLLEY WITH ROTARY TABLE



Working area	890 x 790 x 600 mm
Working pressure	5 ÷ 7 bar
Air consumption	700 ÷ 1000 lit/min
Gun nozzle	8 mm
Max power	400 V 50 Hz 0,4 kW
Filtration rate	99% 5 micron
Weight	480 kg

0615

CAT. 42 € 3500,00

PRESSURE SANDBLAST CABINET

WITH CYCLONE VACUUM CLEANER, HEPA FILTER, FRONT OPENING AND CEILING LIGHT WITH 3 FLUORESCENT LAMPS



Overall dimensions	1330 x 1515 x 2070h mm
Internal dimensions	1180 x 850 x 890h mm
Working pressure	6 ÷ 8 bar
Air consumption	31 SCFM 880 l / min
Gun nozzle	ø 6 - 7 mm
Max power	230 V 50 Hz 0,7 kW
Filtration rate	95% 8 micron
Weight	300 kg

0605

€ 3090,00

SANDBLAST CABINET WITH 2 DUST COLLECTORS

WITH PRESSURIZED TANK TO HAVE A GREATER ABRASIVE EFFECT, 2 CYCLONE-TYPE DUST COLLECTORS, PAPER FILTER, FRONT OPENING AND CEILING LIGHT WITH 3 FLUORESCENT LAMPS



Overall dimensions	1330 x 1515 x 2070h mm
Working area	1180 x 850 x 890h mm
Working pressure	6 ÷ 8 bar
Air consumption	31 SCFM 880 l / min
Gun nozzle	ø 6 - 7 mm
Electric vacuum	2 x 230 V 50 Hz 1,2 kW
Filtration rate	5 micron
Packing dimensions	1330 x 960 x 1070h mm
Weight	245 kg

0601

€ 2530,00

SANDBLAST CABINET WITH DUST COLLECTOR

CYCLONE-TYPE, PAPER FILTER, FRONT OPENING AND CEILING LIGHT WITH 3 FLUORESCENT LAMPS



Overall dimensions	1330 x 1240 x 1770h mm
Working area	1180 x 850 x 890h mm
Working pressure	6 ÷ 8 bar
Air consumption	31 SCFM 880 l / min
Gun nozzle	ø 6 - 7 mm
Electric vacuum	230 V 50 Hz 1,2 kW
Filtration rate	5 micron
Packing dimensions	1330 x 960 x 1070h mm
Weight	160 kg

SA01/CTRx

CAT. 42

ROTARY TABLE FOR SANDBLAST CABINET

Art. SA01 / CTR1 compatible with Art. 0601
 Art. SA01 / CTR2 compatible with Art. 0605 and 0615



Art.	€	Capacity	Diameter	Net weight	Overall dimensions	Weight
SA01/CTR1	€ 417,00	150 kg	580 mm	43,5 kg	920 x 580 x 1070h mm	45 kg
SA01/CTR2	€ 417,00	150 kg	580 mm	45 kg	920 x 580 x 1335h mm	46 kg

0687

€ 1800,00

VERTICAL SANDBLAST CABINET WITH VACUUM

WITH PAPER FILTER



Overall dimensions	1220 x 910 x 1740h mm
Working area	1200 x 600 x 600h mm
Working pressure	6,5 ÷ 7,5 bar
Air consumption	21 SCFM 630 l / min
Gun nozzle	ø 6 - 7 mm
Electric vacuum	230 V 50 Hz 1,2 kW
Filtration rate	5 micron
Packing dimensions	1320 x 1300 x 770h mm
Weight	149 kg



0878

€ 1440,00

VERTICAL SANDBLAST CABINET WITH VACUUM

WITH PAPER FILTER



Overall dimensions	1030 x 850 x 1640h mm
Working area	960 x 480 x 250 ÷ 470h mm
Working pressure	6,5 ÷ 7,5 bar
Air consumption	18 SCFM 540 l / min
Gun nozzle	ø 4 - 5 - 6 - 7 mm
Electric vacuum	230 V 50 Hz 1,2 kW
Filtration rate	5 micron
Packing dimensions	1300 x 1010 x 755h mm
Weight	110 kg





0575S

€ 560,00

SANDBLAST CABINET

IN KIT, PREDISPOSED WITH ADAPTER TO FIT THE MACHINE TO A VACUUM CLEANER, TO PREVENT SAND BLASTING STOP DUE TO DUST FOG CONDITION INSIDE THE MACHINE, WIDE UPPER DOOR, LOW CONSUMPTION WORKING LAMP, SAND BLAST GUN AND GLOVES



Overall dimensions	905 x 620 x 1390h mm
Working area	860 x 560 x 560h mm
Working pressure	6,5 ÷ 7,5 bar
Air consumption	8 ÷ 10 SCFM (240 ÷ 300 l / min)
Gun nozzle	ø 4 - 5 - 6 - 7 mm
Weight	49 kg

0487

€ 247,00

BENCH SANDBLAST



Overall dimensions	755 x 495 x 720 mm
Working area	685 x 455 x 420 mm
Working pressure	6,5 - 7,5 bar
Gun nozzle	ø 4 - 5 - 6 - 7 mm
With light	230 V 50 Hz; 6 W 12 V
Weight	26,5 kg

0575

€ 604,00

VERTICAL SANDBLAST CABINET



Overall dimensions	890 x 560 x 1385h mm
Working area	850 x 480 x 340 ÷ 540h mm
Working pressure	6,5 ÷ 7,5 bar
Air consumption	8 ÷ 10 SCFM (240 ÷ 300 l / min)
Gun nozzle	ø 4 - 5 - 6 - 7 mm
Weight	46 kg

0580S

€ 208,00

BENCH SANDBLAST CABINET

IN KIT, WITH ADAPTER TO FIT THE MACHINE TO A VACUUM CLEANER, TO PREVENT SAND BLASTING STOP DUE TO DUST FOG CONDITION INSIDE THE MACHINE, WIDE UPPER DOOR, LOW CONSUMPTION WORKING LAMP, SAND BLAST GUN AND GLOVES



Overall dimensions	585 x 485 x 495h mm
Working area	560 x 460 x 280h mm
Working pressure	6,5 - 7,5 bar
Air consumption	8 ÷ 10 SCFM (240 ÷ 300 l / min)
Gun nozzle	ø 4 - 5 - 6 - 7 mm
Weight	17 kg

0580

€ 234,00

BENCH SANDBLAST CABINET

WITH ADAPTER TO FIT THE MACHINE TO A VACUUM CLEANER, TO PREVENT SAND BLASTING STOP DUE TO DUST FOG CONDITION INSIDE THE MACHINE



Overall dimensions	630 x 510 x 490h mm
Working area	590 x 480 x 290h mm
Working pressure	6,5 - 7,5 bar
Air consumption	8 ÷ 10 SCFM (240 ÷ 300 l / min)
Gun nozzle	ø 4 - 5 - 6 - 7 mm
Weight	19 kg

0462

€ 643,00

SANDBLAST MACHINE WITH VACUUM

FOR RUSTED METALLIC OBJECTS THAT CAN'T BE PUT IN TRADITIONAL SANDBLAST MACHINE. IF THE OBJECT TO BE CONSIDERED IS FLAT, THE VACUUM CLEANER ALLOWS THE OPERATOR TO NOT LOSE THE MOST PART OF THE ABRASIVE MATERIAL THAT IS BEING USED. THE FOUR WHEELS, TWO OF WHICH SWIVEL, ALLOW THE OPERATOR THAT THE MACHINE IS CLOSE TO THE OBJECT TO BE SANDBLASTED



Tubes length	2,5 m
Single-phase motor	230 V 50 Hz 1,2 kW
Max vacuum capacity	13÷15 kPa
Working pressure	8 bar
Air consumption	420 l/min
Dimensions	404 x 612 x 1046 mm
Weight	40 kg

0490

€ 352,00

MINI BENCH SANDBLAST

WITH FOOT CONTROL AND FIXED GUN



Overall dimensions	475 x 370 x 370 mm
Working area	410 x 310 x 200 mm
Working pressure	4 - 7,5 bar
Gun nozzle	ø 3.5 mm
With light	230 V 50 Hz, 6 W 12 V
Weight	12.5 kg

0310

€ 163,00

SODA BLASTER

FOR EXTERNAL USE, LIGHT WEIGHT, EASY TO CARRY, INDICATED FOR THE REMOVAL OF PAINTS, RUST, GRAFFITI ETC..



Overall dimensions	350 x 400 x 788h mm
Capacity	18 Lit.
Working pressure	2,5 ÷ 6,2 bar
Air consumption	8 ÷ 10 SCFM (240 ÷ 300 l / min)
Gun nozzle	ø 2 - 3 mm
Weight	15 kg



SA01/TR

CAT. 42 € 91,70

ROTARY TABLE

FOR SANDBLAST CABINET

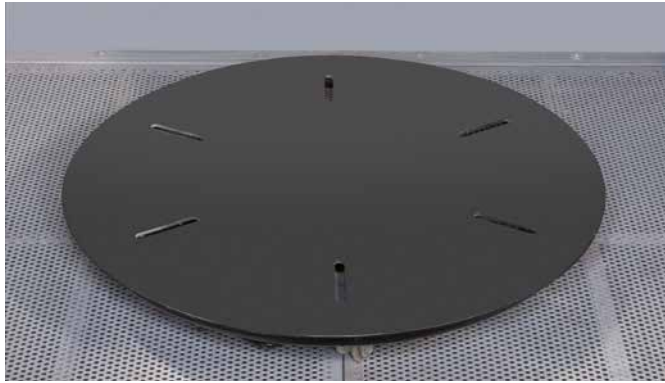

Diameter	380 mm
Net weight	7 kg
Overall dimensions	380 x 43h mm
Weight	7,3 kg
Packing dimensions	390 x 390 x 65 mm

SA01/A

€ 288,00

SANDBLAST CYCLON

CYLINDRICAL WITH CLOSED BASE WITH PAPER FILTER



Electric vacuum	230 V 50 Hz 1,2 kW
Filtration rate	5 micron
Air permeability	185 l/(m²s)
Inlet size	Ø 55 mm
Slot distance	305 X 240 mm
Dimensions	Ø 290 X 730 mm

0581

€ 68,80

MICRO GLASS BEADS

SANDBLAST (FINISHING)



Grit	50 ÷ 70 (0,3 ÷ 0,2 mm)
Hardness	5-7 Mohs
Weight	25 kg

SA01/C

CAT. 42 € 917,00

CYCLONE FOR SAND BLAST CABINET

IN TWO STAGE



Filtration rate	95% 8 micron
Air flow	13500 l/min
Max power	230 V 50 Hz 0,55 kW
Overall dimensions	520 x 880 x 1370h mm
Net weight	60 kg
Weight	63 kg

0310B

€ 60,10

SODA BLASTING MEDIA

SALT COMPOSED BASIC BICARBONATE SYNTHETIC, SUITABLE FOR TREATING STEEL, ALUMINUM, FIBERGLASS, PLASTIC, BRICKS ETC ...



Grit	36 ÷ 80 (0,5 ÷ 0,3 mm)
Hardness	2,5 - 3 Mohs
Weight	25 kg

0582-

SANDBLAST CORUNDUM



Art.	€	Grit	Hardness	Weight
0582/36	€ 77,90	36	9 Mohs	25 kg
0582/80	€ 77,90	80	9 Mohs	25 kg

0490/11

€ 18,30

PAIR OF GLOVES



Gloves diameter 100 mm

05x

PAIR OF GLOVES



Art.	€	Length	Gloves diameter
0575/29	€ 32,40	600 mm	180 mm
0580/21	€ 32,40	450 mm	145 mm

0490/03

€ 20,00

WINDOW PROTECTION SET



5 Pcs

0601/24

€ 18,30

WINDOW PROTECTION SET

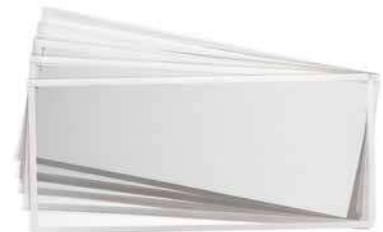

5 Pcs

0601/30

€ 13,30

LAMP PROTECTION SET

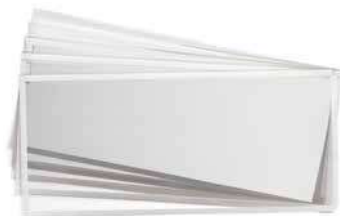

5 Pcs

0687/005

€ 22,40

LAMP PROTECTION SET

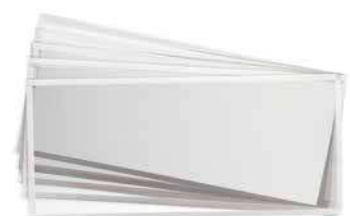

10 Pcs

0575/04

€ 35,20

WINDOW PROTECTION SET

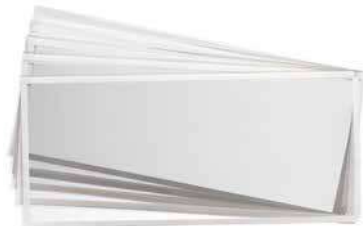

10 Pcs

0580/01-6

€ 22,40

WINDOW PROTECTION SET

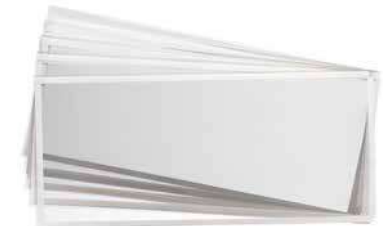

5 Pcs

SA01/F

CAT. 42 € 129,00

CYCLONE FILTER

HEPA MATERIAL



Diameter	320 mm
Height	600 mm
Net weight	0.8 kg
Weight	1 kg
Packing dimensions	325 x 325 x 610 mm

0687/029

€ 60,50

SANDBLAST CYCLON



Diameter	170 mm
Height	305 mm

0687/041

€ 82,50

GUN

SANDER



0290

€ 30,60

SANDBLAST GUN



Ceramic nozzles	ø 4 - 5 - 6 - 7 mm
Rubber hose length	1,5 m



0577/17

FIXED GUN

€ 35,70



U004

COMPOSITE NOZZLE

FOR SAND BLAST CABINET, LONG LIFE

€ 54,20



Nozzle diameter 6 mm

0462/55

CERAMIC NOZZLE SET

€ 29,20



5 Pcs

Nozzle diameter ø 7,5 mm

U003

BORON CARBIDE NOZZLE

FOR SAND BLAST CABINET, LONG LIFE

€ 85,00



Nozzle diameter ø 7,5 mm

0490/20

CERAMIC NOZZLE SET

€ 7,50



4 Pcs

Nozzle diameter ø 3,5 mm

0575/0580/12

CERAMIC NOZZLE SET

€ 14,00



4 Pcs

Nozzle diameter ø 4 - 5 - 6 - 7 mm

0687/102

CERAMIC NOZZLE SET

€ 15,20



4 Pcs

Nozzle diameter ø 6 - 7 mm

COMPATIBILITY CHART

Art.	€	S035P	S035D	0615	0605	0601	0687	0878	0575S	0575	0487	0580S	0580	0490	0462	0310	PAG
SA01/A	288,00																104
SA01/CTR1	417,00																100
SA01/CTR2	417,00																100
SA01/TR	91,70																104
SA01/C	917,00																104
SA01/F	129,00																105
0687/029	60,50																105
0581	68,80																104
0582/36	77,90																104
0582/80	77,90																104
0290	30,60																105
0687/041	82,50																105
0577/17	35,70																106
0490/03	20,00																105
U003	85,00																106
0490/20	7,50																106
0462/55	29,20																106
0575/0580/12	14,00																106
0687/102	15,20																106
0601/24	18,30																105
0601/30	13,30																105

Art.	€	S035P	S035D	0615	0605	0601	0687	0878	0575S	0575	0487	0580S	0580	0490	0462	0310	PAG
0687/005	22,40																105
0575/04	35,20																105
0580/01-6	22,40																105
0490/11	18,30																105
0575/29	32,40																105
0580/21	32,40																105
A040/30A	148,00																109
A040/60A	240,00																109
A024/602	233,00																110
0310B	60,10																104

0305

€ 618,00

PART WASHER WITH HEATING SYSTEM

FOR WASHING WITH HOT WATER UP TO 60° C, WITH A VENTURIUM PNEUMATIC GUN



Dimensions	790 x 610 x 1260h mm
Tank capacity	8 ÷ 14 l
Avg air cons.	5 SCFM 145 l / min
Working area	760 x 560 x 380 mm
Power	1350 W
Washing pressure	5 ÷ 8 bar
Packing dimensions	780 x 620 x 820h mm
Weight	49 kg

0203

€ 472,00

BENCH PART WASHER

FOR WASHING WITH WATER/SOLVENT, WITH A VENTURIUM PNEUMATIC GUN



Dimensions	770 x 595 x 700h mm
Tank capacity	4 ÷ 9 l
Avg air cons.	5 SCFM 145 l / min
Working area	765 x 560 x 380 mm
Power	30 W
Washing pressure	5 ÷ 8 bar
Weight	32 kg

0486

€ 442,00

PARTS WASHER WITH DUAL PUMP



Left tank internal dimensions	470 x 520 x 270 mm
Right tank internal dimensions	590 x 520 x 270 mm
Tub capacity	150 l
Pump	230V 50Hz 26 + 26 W
Pump capacity	10 - 12 l/min
Size	1140 x 550 x 880 mm
Weight	45 kg

0038

€ 230,00

DEGREASER CLEANING TANK



Internal tank dimensions	710 x 480 x 260h mm
Height	880 mm
Tub capacity	75 l
Pump	230V 50Hz 26W
Pump capacity	10-12 l / min
Size	775 x 540 x 880h mm
Weight	25 kg



0232

€ 290,00

DEGREASER CLEANING TANK WITH WHEEL



Internal tank dimensions	710 x 480 x 200h mm
Height	890 mm
Tub capacity	60 l
Pump	230 V 50 Hz 26 W
Pump capacity	10-12 l / min
Size	970 x 540 x 930 h mm
Weight	36 kg

0392

€ 312,00

BENCH MICRO CLEANER

FOR WALL MOUNTING



Capacity	14 l
Neon light	24 V 8 W
Pump	230 V 50 Hz 26 W
Pump capacity	10-12 l / min
Overall sizes	560 x 545 x 635h mm
Weight	27 kg

0233

€ 212,00

MOBILE PARTS WASHER

MADE OF ABS WITH RUBBER SEALS IN NBR



Internal tank dimensions	460 x 660 x 260 mm
Capacity	9 l
Pump	230 V 50 Hz 16 W
Weight	5 kg

0632

€ 653,00

DEGREASER CLEANING PNEUMATIC TANK



Internal tank dimensions	710 x 480 x 200h mm
Height	1015 mm
Tank capacity	50 l
Tub capacity	65 l
Power pressure	0,5 bar
Weight	42 kg

0211

€ 412,00

TEAR-DOWN WORKBENCH WITH FLUID RECOVERY

PROVIDED IN ASSEMBLY KIT, WITH ONE DRAWER EQUIPPED WITH LOCK, REMOVABLE BOWL AND PIVOTING WHEELS, 2 WITH SAFETY BRAKE



Overall sizes	1200 x 640 x 872h mm
Working table dimensions	1190 x 635 x 15h mm
Drawer dimensions	420 x 340 x 120h mm
Internal tank dimensions	360 x 260 x 115h mm
Internal shelf height	445 mm
Maximum capacity with wheels	280 kg
Maximum capacity without wheels	350 kg
Weight	57 kg

0632-

***CAT. 42**

DETERGENT LIQUID



Art.	€	Contents	Specification
0632/D	€ 116,00	25 l	Solvent base
0632/DA	€ 155,00	25 l	Water dilutable max. 50%
0632/DCF	€ 85,00	25 l	Water dilutable max. 20%, hot usage

A024/10**CAT. 42 € 56,70****WET AND DRY VACUUM CLEANER**

WITH ABS TANK, BLOWER FUNCTION, EQUIPPED WITH ACCESSORIES



Power	1,2 kW
Capacity	10 l
Motors	1 (230 V 50 Hz)
Air flow	30 ± 2 l/s
Net weight	3,7 kg
Weight	4,3 kg
Packing dimensions	280 x 280 x 360 mm

A025/30**€ 84,10****WET AND DRY VACUUM CLEANER**

WITH STAINLESS STEEL TANK, BLOWER FUNCTION, EQUIPPED WITH ACCESSORIES



Power	1,2 kW
Capacity	30 l
Motors	1 (230 V 50 Hz)
Air flow	28 l / s
Weight	6,1 kg
Packing dimensions	35,5 x 35,5 x 58 cm mm

A040/30A**€ 148,00****INDUSTRIAL WET AND DRY VACUUM CLEANER EQUIPPED OF ACCESSORIES**

FOR INDUSTRIAL USE, WITH SOCKET FOR ELECTRONIC DEVICES



Power	1,4 kW
Capacity	30 l
Motors	1 (230 V 50 Hz)
Air flow	35 l / s
Power socket	1600 W
Weight	7,5 kg
Packing dimensions	36,5 x 36,5 x 59 cm mm

A040/60A**€ 240,00****INDUSTRIAL WET AND DRY VACUUM CLEANER EQUIPPED OF ACCESSORIES**

FOR INDUSTRIAL USE, WITH SOCKET FOR ELECTRONIC DEVICES



Power	1,4 kW
Capacity	60 l
Motors	1 (230 V 50 Hz)
Air flow	46 l / s
Power socket	1600 W
Weight	13,8 kg
Packing dimensions	49 x 47 x 69 cm mm

A024/602

CAT. 42 € 233,00

60L 2 MOTORS WET AND DRY VACUUM CLEANER
WITH ABS TANK, EQUIPPED WITH ACCESSORIES



Power	2,8 kW
Capacity	60 l
Motors	2 (230 V 50 Hz)
Air flow	30 ±2 l/s
Net weight	12,5 kg
Weight	14,3 kg
Packing dimensions	480 x 455 x 740 mm

A040/802

€ 421,00

80L 2 MOTORS INDUSTRIAL WET AND DRY VACUUM CLEANER
FOR INDUSTRIAL USE, EQUIPPED WITH ACCESSORIES



Power	2 kW
Capacity	80 l
Motors	2 (230 V 50 Hz)
Air flow	75 l/s
Dimensions	60 x 58 x 95 cm
Weight	28 kg

A040/803

€ 521,00

80L 3 MOTORS INDUSTRIAL WET AND DRY VACUUM CLEANER
FOR INDUSTRIAL USE, EQUIPPED OF ACCESSORIES



Power	3 kW
Capacity	80 l
Motors	3 (230 V 50 Hz)
Air flow	96 l/s
Dimensions	60 x 58 x 95 cm
Weight	30 kg

COMPATIBILITY CHART

Art.	€	A030/25	A040/30A	A040/60A	A024/10	A024/602	A040/802	A040/803	PAG
ACAS/001	8,30		•	•					111
ACAS/002	11,70		•	•					111
ACAS/003	8,30		•	•		•			111
ACAS/004	11,70	•	•	•	•	•			111
ACAS/005	8,30	•	•	•	•	•			111
ACAS/006	8,30	•							111
ACAS/007	8,30	•	•						111
ACAS/008	18,30	•			•				111
ACAS/009	8,30	•			•				111
ACAS/010	8,30	•	•	•	•	•			111
ACAS/011	5,00	•	•	•	•	•			111
ACAS/012	17,20		•	•		•			111
ACAS/013	16,70				•				111
ACAS/014	8,30	•	•	•	•	•			111
ACAS/015	7,50	•	•	•	•	•			111
ACAS/016	11,70					•			111
ACAS/017	8,30					•			111
A040/8037	15,00						•	•	111
A040/8040	21,70						•	•	111
A040/8047U	11,70						•	•	111
A040/8047S	10,80						•	•	111
A040/8029	12,50						•	•	111
A040/8046	4,17						•	•	111
A040/8048	6,70						•	•	111



ACAS/001 CAT. 42 € 8,30

3PC INLET SPONGE
FILTER SET FOR
VACUUM CLEANER



ACAS/002 CAT. 42 € 11,70

HEPA FILTER FOR
VACUUM CLEANER



ACAS/003 CAT. 42 € 8,30

FLEXIBLE HOSE FOR
VACUUM CLEANER



Spare parts 1.5 m hose

ACAS/004 CAT. 42 € 11,70

METAL EXTENSION
PIPE FOR VACUUM
CLEANER



ACAS/005 CAT. 42 € 8,30

PAIR OF PLASTIC TUBES FOR VACUUM
CLEANER



ACAS/006 CAT. 42 € 8,30

3PC INLET SPONGE
FILTER SET FOR
VACUUM CLEANER



ACAS/007 CAT. 42 € 8,30

FILTER FOR VACUUM CLEANER



ACAS/008 CAT. 42 € 18,30

10PC PAPER BAG
SET FOR VACUUM
CLEANER



ACAS/009 CAT. 42 € 8,30

FLEXIBLE HOSE FOR
VACUUM CLEANER



ACAS/010 CAT. 42 € 8,30

BIG BRUSH FOR VACUUM CLEANER



ACAS/011 CAT. 42 € 5,00

MULTI FUNCTION BRUSH FOR VACUUM
CLEANER



ACAS/012 CAT. 42 € 17,20

10PC PAPER BAG
SET FOR VACUUM
CLEANER



ACAS/013 CAT. 42 € 16,70

10PC BAG SET
IN PAPER FOR VACUUM
CLEANER



ACAS/014 CAT. 42 € 8,30

3PC PLASTIC TUBE
SET
FOR VACUUM CLEANER



ACAS/015 CAT. 42 € 7,50

SMALL BRUSH
FOR VACUUM CLEANER



ACAS/016 CAT. 42 € 11,70

HEPA FILTER
FOR VACUUM CLEANER



ACAS/017 CAT. 42 € 8,30

3PC INLET SPONGE
FILTER SET
FOR VACUUM CLEANER



A040/8037 € 15,00

FLEXIBLE HOSE FOR
VACUUM CLEANER



A040/8040 € 21,70

PAIR OF METAL
TUBES FOR
VACUUM CLEANER



A040/8047U € 11,70

WET BRUSH FOR
VACUUM CLEANER



A040/8047S € 10,80

DRY BRUSH FOR
VACUUM CLEANERS



A040/8029 € 12,50

FILTER FOR VACUUM CLEANER



A040/8046 € 4,17

SHORT TIP FOR
VACUUM CLEANER



A040/8048 € 6,70

ROUND BRUSH FOR
VACUUM CLEANER



M041

€ 5920,00

PORTABLE PNEUMATIC DOT MARKING MACHINE

WITH TOUCH SCREEN COMPUTER



Working area	110 x 40 mm
Working speed	3 - 5 Characters / sec
Workpiece allowed hardness	<= HRC62
Weight	68 kg

M040

€ 4910,00

PNEUMATIC DOT MARKING MACHINE

USB PORT, WINDOWS XP AND WINDOWS 7 32 BIT SOFTWARE

USB port

Windows XP and Windows 7 32 bit software

Pin sleeve & pin 3 x 12 mm (Art. M040/P12)

Pin sleeve & pin 3 x 14 mm (Art. M040/P14)

Pin sleeve & pin 4 x 20 mm (Art. M040/P20)

Pin sleeve adapter 4 x 20 mm (Art. M040/R)



Working area	110 x 80 mm
Working speed	30 - 40 mm / sec
Table dimensions	320 x 300 mm
Workpiece allowed hardness	
Weight	68 kg



M040/CF

€ 108,00

WIRE CONTROL FOR DOT MARKING MACHINE



M040/CP

€ 233,00

FOOT CONTROL FOR DOT MARKING MACHINE



M040/D

€ 1570,00

DIVIDER FOR DOT MARKING MACHINE



M040/SA

€ 125,00

SHAFTS SUPPORT FOR DOT MARKING MACHINE



M040/SP

€ 286,00

SUPPORT FOR PLATES FOR DOT MARKING MACHINE



M040/ST

€ 108,00

TUBE SUPPORT FOR DOT MARKING MACHINE



P012-L

HRC 58-60 LETTERS

CHROME-VANADIUM, 27 PIECES



Art.	€	Punch dimensions	Shank dimensions
P012/L03	€ 14,00	3 mm	6 x 6 x 60h mm
P012/L04	€ 14,60	4 mm	7 x 7 x 61h mm
P012/L05	€ 16,40	5 mm	7,5 x 7,5 x 61h mm
P012/L06	€ 18,30	6 mm	8,8 x 8,8 x 63h mm
P012/L08	€ 23,90	8 mm	10 x 10 x 66h mm

P012-N

NUMBERS HRC 58-60

CHROME-VANADIUM, 9 PIECES



Art.	€	Punch dimensions	Shank dimensions
P012/N03	€ 7,70	3 mm	6 x 6 x 60h mm
P012/N04	€ 8,60	4 mm	7 x 7 x 61h mm
P012/N05	€ 9,30	5 mm	7,5 x 7,5 x 61h mm
P012/N06	€ 10,30	6 mm	8,8 x 8,8 x 63h mm
P012/N08	€ 11,30	8 mm	10 x 10 x 66h mm

P021

€ 20,60

ELECTRIC ENGRAVER

ON BATTERY, WITH 2 DIAMOND TIP Ø 2.35 mm, LIGHT WEIGHT EASY TO USE, SUITABLE FOR ENGRAVING GLASS, CERAMIC, PLASTIC, WOOD, INOX, BRASS, ALUMINUM, SOFT STEEL



Blister

Speeds	20000 rpm
Length	160 mm
Not included batteries	2 x 1,5 V AAA
Weight	55 g

P012-LxP

HRC 58-60 LETTERS

MICRO STRESS, CHROME-VANADIUM, 27 PIECES



Art.	€	Punch dimensions	Shank dimensions
P012/L03P	€ 30,60	3 mm	7 x 7 x 61h mm
P012/L04P	€ 33,30	4 mm	7,5 x 7,5 x 61h mm
P012/L05P	€ 37,00	5 mm	8,8 x 8,8 x 63h mm
P012/L06P	€ 43,30	6 mm	10 x 10 x 66h mm
P012/L08P	€ 73,30	8 mm	12 x 12 x 70h mm

P012-NxP

NUMBERS HRC 58-60

CHROME-VANADIUM, 9 PIECES



Art.	€	Punch dimensions	Shank dimensions
P012/N03P	€ 14,00	3 mm	7 x 7 x 61h mm
P012/N04P	€ 16,80	4 mm	7,5 x 7,5 x 61h mm
P012/N05P	€ 21,00	5 mm	8,8 x 8,8 x 63h mm
P012/N06P	€ 24,10	6 mm	10 x 10 x 66h mm
P012/N08P	€ 28,80	8 mm	12 x 12 x 70h mm

P002

€ 3,33

ENGINEER'S SCRIBER WITH METAL BODY AND HARD-METAL POINT



Length	145 mm
--------	--------

P005

€ 3,80

STEEL ENGINEER'S SCRIBER



Length	200 mm
--------	--------



P039

CAT. 42 € 5,80

ENGINEER'S SCRIBER WITH METAL BODY AND HARD-METAL POINT



Telescopic	
Length	150 mm
Weight	0.02 kg

P039/PR

CAT. 42 € 4,17

2 PCS SET HARD-METAL POINT

☞ 2



Length	40 mm
Weight	0.01 kg

P020

€ 23,10

ELECTRIC VIBRATING ENGRAVER

WITH VIBRATION ADJUSTMENT, SUITABLE FOR ENGRAVING GLASS, CERAMIC, PLASTIC, WOOD, INOX, BRASS, ALUMINUM, SOFT STEEL



Vibrations	7200 / min
Power	230 V 50 Hz 13 W

P020/P

€ 6,40

SPARE PART BIT SET

☞ 2 Pcs



PRESSES



Capacity (Ton)

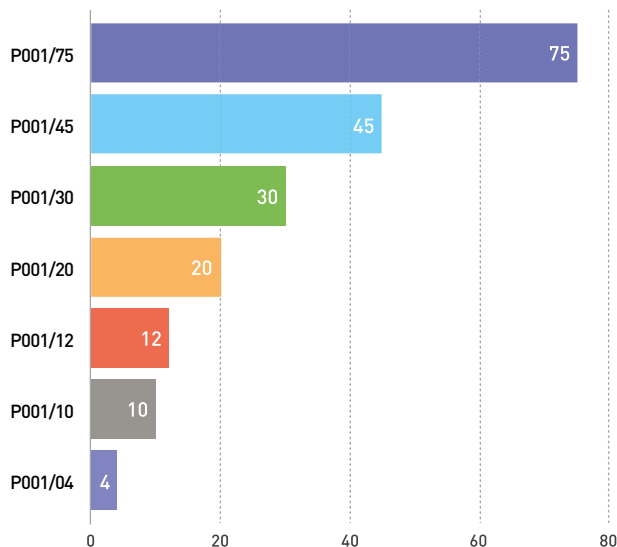

Ram stroke (mm)

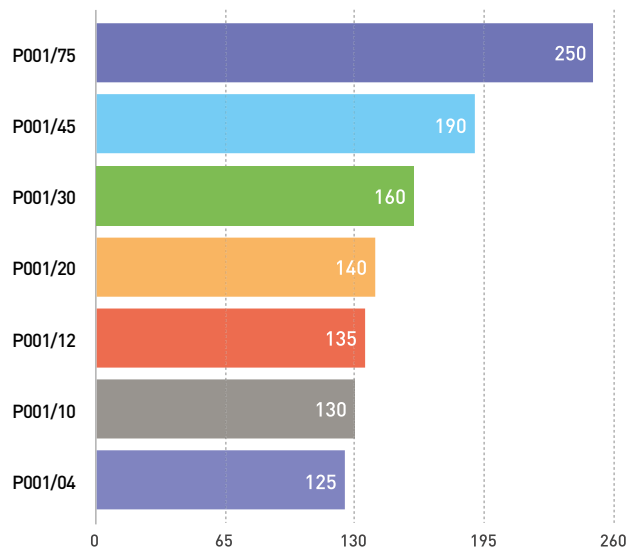

P001/75

€ 4330,00

PNEUMATIC HYDRAULIC SHOP PRESS

75 TON, MADE OF STEEL, WITH MOVEABLE HYDRAULIC PISTON ON WHEELS, WITH TWO-SPEED MANUAL CONTROL AND PNEUMATIC DOWN FOOT PEDAL CONTROL

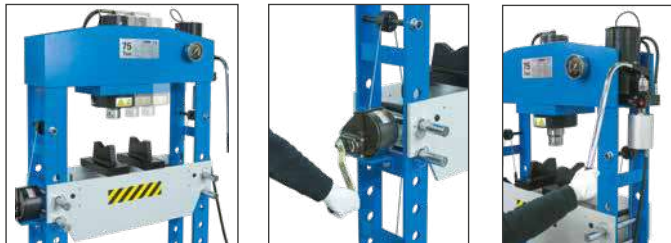

Capacity	75000 kg
Working area	800 x 279 x 850h mm
Ram ø	125 mm
Ram diameter	78 mm
Ram stroke	250 mm
Working pressure	0,75 ÷ 0,85 MPa
Dimensions	1140 x 800 x 1896 mm
Weight	498 kg

P001/45

€ 2260,00

HYDRAULIC SHOP PRESS WITH MANUAL PNEUMATIC CONTROL



Capacity	45000 kg
Working area	830 x 360 x 1000h mm
Cylinder ø	90 mm
Ram ø	58 mm
Ram stroke	190 mm
Working pressure	7÷ 8 bar
Max. pressure	63,5 MPa
Overall sizes	1400 x 800 x 1700h mm
Weight	305 kg

P001/30

€ 895,00

HYDRAULIC SHOP PRESS

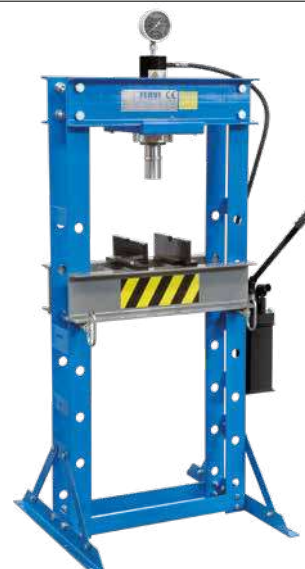
TWO SPEED, WITH MOVABLE PISTON



Capacity	30000 kg
Working area	525 x 290 x 980h mm
Cylinder ø	92 mm
Ram ø	75 mm
Ram stroke	160 mm
Max. pressure	69 MPa
Overall sizes	875 x 700 x 1780h mm
Weight	148 kg

P001/20

€ 730,00

HYDRAULIC SHOP PRESS

WITH MOVEABLE PISTON



Capacity	20000 kg
Working area	495 x 200 x 1125h mm
Cylinder ø	75 mm
Ram ø	48 mm
Ram stroke	140 mm
Max. pressure	69.3 MPa
Overall sizes	690 x 600 x 1830h mm
Weight	88 kg

P001/12

€ 442,00

HYDRAULIC SHOP PRESS

WITH MOVABLE PISTON



Capacity	12000 kg
Working area	480 x 190 x 900h mm
Cylinder ø	56 mm
Ram ø	38 mm
Ram stroke	135 mm
Max. pressure	69 MPa
Overall sizes	730 x 550 x 1600h mm
Weight	62 kg

P001/10

€ 361,00

HYDRAULIC SHOP PRESS

WITH BENCH AND MOVABLE PISTON



Capacity	10000 kg
Working area	340 x 140 x 370h mm
Cylinder ø	53,8 mm
Ram ø	45 mm
Ram stroke	130 mm
Max. pressure	69 MPa
Overall sizes	565 x 500 x 1040h mm
Weight	45 kg



P001/04

€ 241,00

HYDRAULIC SHOP PRESS



Capacity	4000 kg
Working area	350 x 115 x 325h mm
Cylinder ø	ø 40 mm
Ram ø	ø 25 mm
Ram stroke	125 mm
Max. pressure	51 MPa
Overall sizes	450 x 400 x 655h mm
Weight	29 kg

0485

CAT. 42 € 79,20

SHOP PRESS PIN SET

OF 20T AND 30T

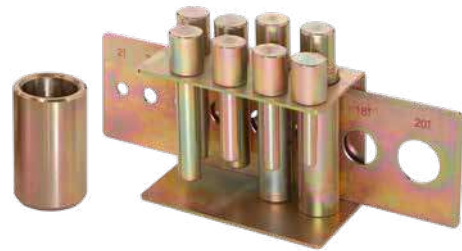

P022-

RATCHET ARBOR PRESS

WITH REMOVEABLE REVOLVING TABLE



P022/05



P022/10



P022/20

Art.	€	Capacity	Max height piece	Max ø piece	Arbor size	Packing dimensions	Weight
P022/05	€ 73,00	5000 N	90 mm	160 mm	19 x 19 mm	250 x 160 x 270 mm	8 kg
P022/10	€ 103,00	10000 N	100 mm	180 mm	25 x 25 mm	250 x 160 x 300 mm	12 kg
P022/20	€ 240,00	20000 N	170 mm	260 mm	30 x 30 mm	415 x 245 x 445 mm	28 kg

P029-

RATCHET ARBOR PRESS

WITH REMOVEABLE REVOLVING TABLE



Art.	€	Capacity	Overall sizes	Max height piece	Max ø piece	Arbor size	Weight
P029/2	€ 274,00	15000 N	400 x 175 x 450h mm	210 mm	300 mm	31,5 x 31,5mm	42 kg
P029/3	€ 347,00	25000 N	450 x 200 x 570h mm	310 mm	300 mm	37,8 x 37,8mm	57 kg

P028-

HAND PUNCH

WITH SPRING LOADED RETURN



Art.	€	Capacity	Overall sizes	Max height piece	Max ø piece	Spindle travel	Weight
P028/07	€ 108,00	1500 N	240 x 155 x 335h mm	170 mm	160 mm	60 mm	9 kg
P028/14	€ 183,00	2000 N	280 x 170 x 760h mm	275 mm	180 mm	70 mm	19 kg

0054-

HYDRAULIC BODY FRAME REPAIR KIT



0054/10



0054/4

Art.	€	Capacity	Ram length	Ram stroke	Weight
0054/10	€ 304,00	10 ton	330 mm	130 mm	33 kg
0054/4	€ 245,00	4 ton	270 mm	120 mm	17 kg

0664

€ 276,00

HYDRAULIC PUMP WITH PNEUMATIC PEDAL CONTROL

USEFUL FOR SHOP PRESS, TROLLEY JACKS AND RAMS



Rated pressure	70 MPa
Working pressure	7 ÷ 8 bar
Usable oil capacity	690 c.c.
Air consumption	10 SCFM
Packing dimensions	380 x 180 x 200 mm
Weight	9 kg

0663

€ 100,00

PULL BACK RAM



Capacity	5 ton
Length Closed	560 mm
Length Open	690 mm
Shank	ø 33 mm
Swing	130 mm
Weight	5,5 kg

0271

€ 112,00

HYDRAULIC PUMP



Rated pressure	63,7 MPa
Usable oil capacity	790 ml
Packing dimensions	73 x 37,5 x 19 mm
Weight	7,7 kg

COMPATIBILITY CHART

Art.	€	P001/75	P001/45	P001/30	P001/20	P001/12	P001/10	P001/04	0664	0271	0663	0054/10	0054/4	PAG
0485	79,20			•	•									118
0256/05	45,80								•	•	•	•	•	129
0256/10	77,90								•	•	•	•	•	129
0256/20	95,80								•	•	•	•	•	129
0256/30	105,00								•	•	•	•	•	129
0256/50	150,00								•	•	•	•	•	129
0664	276,00			•	•	•	•	•			•	•	•	119
0271	112,00			•	•	•	•	•			•	•	•	119
0663	100,00								•	•		•	•	119
0785/1F	8,30	•	•											467
0777/2	31,90	•	•											469
0777/3	56,60	•	•											469
S100/10X6.5	19,00	•	•											467
S100/12X8	21,00	•	•											467
S100/08X5	12,90	•	•											467
S075/08X5	10,70	•	•											467
S075/10X6.5	15,00	•	•											467





0567

CAT. 42 € 81,70

LOW PROFILE HYDRAULIC TROLLEY JACK

2 TONS, MADE OF STEEL



Capacity	2 ton
Lifting	90 ÷ 385 mm
Dimensions	mm
Net weight	13,00 kg
Weight	13,5 kg
Packing dimensions	mm

0369

€ 283,00

HYDRAULIC TROLLEY JACK

DUAL PUMP, WITH REMOVEABLE SADDLE AND RUBBER PAD



Capacity	3,5 ton
Overall sizes	745 x 335 x 180 mm
Lifting	110 ÷ 560 mm
Weight	46 kg

0065

€ 186,00

HYDRAULIC TROLLEY JACK

WITH REMOVEABLE SADDLE



Capacity	2,25 ton
Overall sizes	625 x 350 x 170 mm
Lifting	145 ÷ 530 mm
Weight	38 kg

0457

€ 455,00

LOW PROFILE JACK

2 TONS, MADE OF STEEL, WITH ROUND HANDLE



Capacity	2 ton
Lifting	70 ÷ 500 mm
Dimensions	785 x 350 x 152 mm
Weight	43 kg

0375A

CAT. 42 € 233,00

LOW PROFILE HYDRAULIC TROLLEY JACK

2,5 TON, DOUBLE PUMP QUICK LIFT



Capacity	2,5 ton
Lifting	75 ÷ 500 mm
Dimensions	mm
Net weight	32,5 kg
Weight	33,5 kg
Packing dimensions	670 x 330 x 150h mm

C038/30

€ 146,00

HYDRAULIC TROLLEY JACK

HYDRAULIC TROLLEY JACK



Capacity	3 ton
Overall sizes	572 x 328 x 175h mm
Lifting	130 ÷ 465 mm
Weight	28 kg

0060

€ 60,10

HYDRAULIC TROLLEY JACK



Capacity	2 ton
Overall sizes	535 x 225 x 145 mm
Lifting	135 ÷ 385 mm
Weight	11 kg

C039/25

€ 249,00

HYDRAULIC TROLLEY JACK

ALUMINIUM AND STEEL HYDRAULIC TROLLEY JACK WITH DOUBLE PUMP



Capacity	2,5 ton
Overall sizes	659 x 289 x 165h mm
Lifting	110 ÷ 460 mm
Weight	27 kg



C039/15

€ 180,00

HYDRAULIC TROLLEY JACK

ALUMINIUM AND STEEL HYDRAULIC TROLLEY JACK WITH DOUBLE PUMP



Capacity	1,5 ton
Overall sizes	490 x 270 x 130h mm
Lifting	90 ÷ 358 mm
Weight	15 kg

0658

€ 678,00

HYDRAULIC JACK



Capacity	10 ton
Lifting range of foot	30 ÷ 260 mm
Lifting range of head	420 ÷ 665 mm
Weight	37 kg

0067

€ 23,10

COUPLE JACK STAND

2 TONS



Capacity	2 ton
Heights	240 - 270 - 320 - 365 mm
Weight	3 kg

0069-

COUPLE JACK STAND

ADJUSTABLE HEIGHT, WITH DOUBLE SECURITY LOCKING



Art.	€	Capacity	Height min - max	Base dimensions	Weight
0069/3	€ 38,10	3 ton	298 ÷ 428 mm	190 x 210 mm	6,4 kg
0069/6	€ 70,80	6 ton	400 ÷ 610 mm	260 x 285 mm	13 kg
0069/10	€ 156,00	10 ton	468 ÷ 718 mm	290 x 328 mm	29 kg



0072A

€ 481,00

HYDRAULIC FOLDING CRANE

EASY TO MOVE IN FOLDING POSITION TOO



Capacity	1000 kg
Dimensions	1510 x 1045 x 1365h mm
Fold dimensions	500 x 505 x 1435h mm
Hook heights with lowered arm	0 - 130 - 230 - 330 mm (250 - 500 - 750 - 1000kg)
Hook heights with raised arm	2050 - 1980 - 1900 - 1830 mm (250 - 500 - 750 - 1000kg)
Boom extension	890 - 780 - 670 - 580 mm (250 - 500 - 750 - 1000 kg)
Front opening	870 mm
Front wheel height	80 mm
Weight	82 kg

0094

€ 275,00

TRANSMISSION JACK

WITH CROSS AND TILTING SUPPORTS, HELPS YOU SAFELY POSITION, ALIGN AND REMOVE TRANSMISSIONS FOR USE UNDER LIFTS



Capacity	500 kg
Dimensions	1190 x 700 x 660 mm
Min - Max height	1190 ÷ 2000 mm
Weight	37 kg

S019

€ 118,00

ENGINE STAND

2 WHEELS WITH BREAKS AND 2 FIX WHEELS, POSSIBILITY TO TILT THE MOTOR



Capacity	450 kg
Overall sizes	865 x 810 x 870 mm
Weight	22 kg

0063

€ 549,00

HYDRAULIC FOLDING CRANE



Capacity	1000 kg
Overall sizes	1800 x 1000 x 1500h mm
Fold dimensions	800 x 860 x 1600h mm
Hook height	480 ÷ 2100 mm (1000 kg)
Hook height	0 ÷ 2550 mm (250 kg)
Min/max boom extension	680 ÷ 1220 mm
Front opening	800 mm
Weight	95 kg

S024

€ 113,00

ENGINE SUPPORT

ENGINE SUPPORT HOLDS YOUR ENGINE OR TRANSMISSION IN PLACE DURING HEAVY AUTOMOTIVE REPAIRS, USED TO SUPPORT THE ENGINE WHILE REMOVING GEAR BOX, TRANSMISSION, REPLACING CLUTCH AND ALL MOTOR MOUNTS. RUBBER FEET FOR SAFE HOLD OF MOTOR, EASY REGULATION FOR HOLD ENGINE IN ITS PLACE IN THE CAR. SWIVEL AND TILTING HOLDERS.



Capacity	500 kg
Adjusting height	205 mm
Bed length	730 ÷ 1480 mm
Weight	18 kg

0147

€ 47,20

SHOP CRANE LEVELER

SHOP CRANE AND CRANE LEVELER, EASY TO USE, JUST CRANK TO LEVEL, TILTS FORWARD AND BACKWARD FOR EASY MOTOR MOUNT ALIGNMENT



Capacity	680 kg
Width	440 mm
Max stroke of slide	330 mm
Chain	350 mm
Weight	6 kg

0594

€ 116,00

OIL DRAINER WITHOUT TANK

WITH WHEELS, TO USE UNDER LIFTS, FOR WASTE OIL



Base dimensions	390 x 390 mm
Height max	1700 mm
Weight	15 kg

0595

€ 233,00

OIL DRAINER

WITH TANK AND WHEELS, TO USE UNDER LIFTS, FOR WASTE OIL



Tank capacity	70 l
Height min - max	1170 ÷ 1860 mm
Weight	26 kg



0596

€ 374,00

PNEUMATIC OIL DRAINER

WITH WHEELS AND DIFFERENT SIZE OF SUCTION PROBES, FOR WASTE OIL, FOR USE UNDER LIFTS TOO



Tank capacity	70 l
Measuring tank capacity	10 l
Height max	1410 mm
Metal probe	2x ø 6 x 5 mm
Nylon probe	2x ø 8 x 7 mm - 2x ø 6 x 5 mm
Suction	6 x 4,5 mm - 0,4 ÷ 0,8 L/min 8 x 6,5 mm - 1 ÷ 1,6 L/min
Power pressure	8 ÷ 10 bar
Weight	22,5 kg



0630/2720

€ 833,00

12 V ELECTRIC WINCH - DIRECT CURRENT



55

Rated line pull	2720 kg
Speeds	1,3 - 4,5 m / min
Motor: permanent magnet	12 V 1,3 kW 1,8 hp
Gear Reduction ratio	294:1
Cable size	ø 7,2 mm x 32 m
Drum dimensions	ø 63 x 228 mm
Overall dimensions	520 x 180 x 175h mm
Weight	29 kg

0630/2200

€ 613,00

12 V ELECTRIC WINCH - DIRECT CURRENT



55

Rated line pull	2000 kg
Speeds	1,5 - 3,6 m / min
Motor: permanent magnet	12 V 1,0 kW 1,3 hp
Gear Reduction ratio	172:1
Cable size	ø 6,4 mm x 14,5 m
Drum dimensions	ø 45 x 97 mm
Overall dimensions	364 x 126 x 141h mm
Weight	13 kg



0630/0900

€ 248,00

12 V ELECTRIC WINCH - DIRECT CURRENT



IP 55

Rated line pull	450 / 900 kg
Speeds	1,3 - 3,2 m / min
Motor: permanent magnet	12V 0,7 kW 0,9 hp
Gear Reduction ratio	153:1
Cable size	ø 4 mm x 15 m
Drum dimensions	ø 31,5 x 73 mm
Overall dimensions	285 x 105 x 105h mm
Weight	6,7 kg

R015

€ 133,00

2 PC CAR RAMPS SET

MADE OF POLYPROPYLENE, WITH A MAX. CAPACITY OF 2.5 TON



Overall sizes	905 x 330 x 218 mm
Capacity	2,5 ton
Max tire width	240 mm
Min - Max height	170 mm
Tilting	15°
Weight	8 kg

0649-

ALUMINUM RAMPS



Art.	€	Overall sizes	Capacity	Max Working angle	Max Working height	Weight
0649/1500	€ 300,00	1520 x 735 mm	170 kg	12,5 % (7°)	180 mm	14 kg
0649/1800	€ 373,00	1800 x 735 mm	150 kg	12,5 % (7°)	220 mm	17 kg

0598

€ 16,30

PARKING GUIDE MAT

MADE OF POLYPROPYLENE MATERIAL



Overall sizes	685 x 305 x 38 mm
Weight	1,16 kg

0592

€ 6,00

GARAGE WALL GUARD

MADE OF POLYPROPYLENE MATERIAL



Dimensions	640 x 165 x 15 mm
Weight	0,45 kg

0447

€ 52,30

12 V - 2 A INTELLIGENT DIGITAL BATTERY CHARGER

MICRO-PROCESSOR BUILT-IN, 3 STAGE AUTOMATIC CHARGE, BATTERY TYPE: LEAD ACID, AGM, GEL, WET, VRLA, MF CHARGING MODE: 14.4V 2A, LONG LIFE BATTERY MAINTAINING MODE

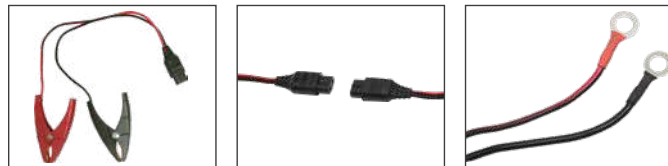

Hanger

Power	220 ÷ 240 V, 50 ÷ 60 Hz
Power	14,4 V 4 A max
Weight	430 g

0432

€ 76,50

6 - 12 V - 4 A INTELLIGENT DIGITAL BATTERY CHARGER

MICRO-PROCESSOR BUILT-IN, BATTERY RECOVERY MODE, 9 STAGE AUTOMATIC CHARGE, BATTERY TYPE: LEAD ACID, AGM, GEL, WET, VRLA, MF MOTORBIKE MODE: 14.4V 1A, CAR MODE: 14.4V 4A, WINTER MODE: 14.7V 4A, 6V BATTERY CHARGE MODE: 7.2V 4A, LONG LIFE BATTERY MAINTAINING MODE

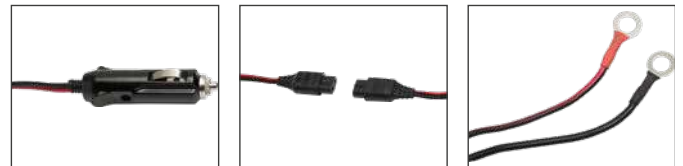

Hanger

Power	230 V 50 ÷ 60 Hz
Power	14,7 V 4 A max
Weight	500 g

0478

€ 107,00

12 V - 8 A INTELLIGENT DIGITAL BATTERY CHARGER

SUITABLE FOR CHARGING ALL TYPES OF 12V LEAD-ACID BATTERIES INCLUDING WET, GEL AND AGM. THIS CHARGER ALSO CHARGES BATTERIES IN COLD CONDITIONS. WITH ADVANCED 9-STEP CHARGING PROGRAMME, THIS CHARGER RECHARGES THE BATTERIES AT ALMOST 100% OF THEIR ORIGINAL CAPACITY. IT CAN AUTOMATICALLY RECOVER SLIGHTLY SULPHATED BATTERIES. CHARGE AND RESCUE DRAINED BATTERIES.

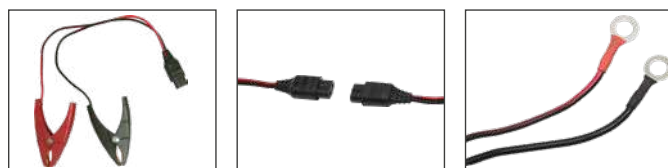

Power	230 V, 50 ÷ 60 Hz
Power	14,4 V, 8 A
Weight	1,07 kg

0479

€ 118,00

12 V 2 - 6 - 12A INTELLIGENT DIGITAL BATTERY CHARGER

3 STEP, WITH SOCKET FOR DC 12V 12A DEVICES



Power	230V 50Hz
Power	12 V 2 - 6 - 12 A
Weight	1,4 kg





S029

CAT. 42 € 2080,00

ELECTRO-HYDRAULIC MOTORCYCLE LIFT



Max lifting capacity	600 kg
Platform dimensions	2200 x 750 mm
Total length	2995 mm
Service hole dimensions	550 x 340 mm
Min - Max height	215 - 520 - 625 - 710 - 780 - 840 mm
Vice	330 x 320 mm
Vice opening	50 ÷ 200 mm
Single-phase motor	230V 50Hz 550W
Net weight	235 kg
Weight	255 kg
Packing dimensions	2230 x 810 x 445h mm

S027

CAT. 42 € 1900,00

ELECTRO-HYDRAULIC MOTORCYCLE LIFT



Max lifting capacity	600 kg
Platform dimensions	1800 x 600 mm
Total length	2600 mm
Service hole dimensions	550 x 340 mm
Min - Max height	260 ÷ 880 mm
Vice	330 x 320 mm
Vice opening	40 ÷ 200 mm
Motor	230V 50Hz 550W
Weight	210 kg

S029P

CAT. 42 € 2250,00

ELECTRO-HYDRAULIC MOTORCYCLE LIFT

WITH PUMP AND SEPARATE CONTROL SYSTEM THAT GIVE THE POSSIBILITY TO POSITION IT AT FLOOR LEVEL



Max lifting capacity	600 kg
Platform dimensions	2200 x 750 mm
Total length	2995 mm
Service hole dimensions	550 x 340 mm
Min - Max height	215 - 520 - 625 - 710 - 780 - 840 mm
Vice	330 x 320 mm
Vice opening	50 ÷ 200 mm
Single-phase motor	230V 50Hz 550W
Net weight	260kg
Packing dimensions	2230 x 810 x 445h mm

S027ATV

CAT. 42 € 2520,00

ELECTRO-HYDRAULIC ATV & MOTORCYCLE LIFT



Max lifting capacity	600 kg
Platform dimensions	1800 x 1200 mm
Total length	2600 mm
Service hole dimensions	550 x 340 mm
Min - Max height	260 ÷ 880 mm
Vice	330 x 320 mm
Vice opening	40 ÷ 200 mm
Motor	230V 50Hz 550W
Weight	280 kg

S008/M

€ 766,00

HYDRAULIC MOTORCYCLE LIFT TABLE

WITH FOOT PUMP



Max lifting capacity	400 kg
Platform dimensions	1825 x 660 mm
Total length	2500 mm
Min - Max height	195 ÷ 750 mm
Weight	160 kg

S013

€ 1500,00

HYDRAULIC LIFT TABLE

WITH FOOT PUMP AND PNEUMATIC CONTROL



Max lifting capacity	600 kg
Platform dimensions	2000 x 1220 mm
Total length	2575 mm
Min - Max height	185 ÷ 825 mm
Weight	230 kg



0452

€ 126,00

MOTORCYCLE SCISSORS LIFT

SCISSOR SUPPORT STAND SUITABLE FOR USE ON THE FLOOR OR ON A MOTORCYCLE LIFT TO REPAIR BYKES



Max lifting capacity	400 kg
Platform dimensions	470 x 150 mm
Min - Max height	95 ÷ 400
Weight	14 kg

0430

€ 210,00

MOTORCYCLE DOLLY

POWDER COATED STEEL. IT IS SUITABLE FOR MOTORCYCLES AND SCOOTERS THAT HAVE THE SIDE STAND. IT ALLOWS YOU TO MOVE AND TO PARK YOUR BIKE IN TIGHT SPACES



Lifting capacity	300 kg
Length	1929 mm
Weight	32,5 / 30 kg
Packing dimensions	1100 x 405 x 135 mm

0241

€ 81,50

MOTORCYCLE WHEEL BLOCK

STRONG BODY, SIMPLE AND EASY USE, ADJUSTABLE WHEEL SIZE, SAFETY LOCK



Wheel sizes	15" - 21"
Overall dimensions	730 x 468 x 440h mm
Weight	20 kg

0217

€ 163,00

VEHICLE POSITIONING JACK

WITH WHEEL POSITIONING BRAKES, STRONG BODY, EASY USE, USING 4 POSITIONERS, ONE FOR EVERY WHEEL, ALLOWS TO MOVE THE CAR IN SMALL SPACES, IN ALL DIRECTIONS

Capacity	680 kg
Lateral stroke	370 mm
Working range	710 - 340 mm
Max tire width	325 mm
Overall dimensions	730 x 468 x 440h mm
Weight	15,6 kg





S017

€ 172,00

UNIVERSAL TELESCOPIC CART

ADJUSTABLE IN HEIGHT AND LENGTH, MADE OF SQUARE STEEL PIPES, AFTER USE IT CAN BE STORED IN SMALL SPACE, UPPER SIDES WITH RUBBER TO PREVENT SCRATCHES AND GIVE MORE STABILITY TO THE LEANED OBJECT, 4 SWIVEL CASTERS OF WHICH 2 WITH BRAKE, IDEAL FOR THE CAR BODY REPAIR, FOR REPAIRING AND SPRAYING AREA



Height min - max	840 ÷ 1320 mm
Length	225 ÷ 1380 mm
Width	860 mm
Capacity	100 kg
Weight	33 kg

0645/CP

€ 55,70

PLASTIC CREEPER



Box

Overall sizes	1000 x 470 x 120h mm
Weight	5,5 kg

0645/CS

€ 83,10

2 IN 1 CREEPER AND SEAT



Box

Creeper dimensions	1030 x 420 x 125h mm
Seat dimensions	630 x 420 x 410h mm
Weight	11 kg

0645/S

€ 44,80

SHOP SEAT



Box

Overall sizes	368 x 360 x 365 mm
Weight	3,8 kg

0645/CC

€ 75,50

THREE-DRAWER CAR SEAT

EQUIPPED WITH 3 DRAWERS WITH BEARINGS, 3 CAN TRAYS AND A SMALL FRONTAL TRAY, 4 PIVOTING WHEELS



Box

Overall sizes	370 x 400 x 367h mm
3 drawers	190 x 300 x 40h mm
Weight	8 kg

0645/C

€ 50,00

6 WHEELS CAR CREEPER



Box

Overall sizes	1030 x 420 x 110h mm
Weight	6,5 kg

0645/SS

€ 55,00

2 IN 1 CREEPER AND SEAT



Box

Creeper dimensions	1020 x 410 x 150h mm
Seat dimensions	550 x 410 x 500h mm
Weight	9 kg

0256-

HYDRAULIC RAM



Art.	€	Lifting capacity	Working pressure	Min-max lifting height	Shank	Ram stroke	Dimensions	Weight
0256/05	€ 45,80	5 ton	63 Mpa	33 + 39 mm	ø 24 mm	6 mm	45 x 95 mm	0,65 kg
0256/10	€ 77,90	10 ton	63.7 Mpa	44 + 55 mm	ø 38 mm	11 mm	56 x 118 mm	1,80 kg
0256/20	€ 95,80	20 ton	63.7 Mpa	52 + 63 mm	ø 50 mm	11 mm	76 x 138 mm	2,80 kg
0256/30	€ 105,00	30 ton	63.7 Mpa	60 + 72 mm	ø 63 mm	12 mm	95 x 158 mm	4,75 kg
0256/50	€ 150,00	50 ton	63.7 Mpa	66 + 78 mm	ø 70 mm	12 mm	118 x 186 mm	6,80 kg

0062-

BOTTLE JACK

HYDRAULIC JACK. IT PROVIDES AN EXCELLENT STABILITY THANKS TO ITS SMALL SIZE. EASY TO CARRY AND USE



Art.	€	Capacity	Min. height	Lifting	Adjusting height	Base dimensions	Ram diameter	Weight
0062/2	€ 20,80	2 ton	181 mm	116 mm	48 mm	90 x 85 mm	Ø 22 mm	2,7 kg
0062/5	€ 32,40	5 ton	220 mm	127 mm	70 mm	115 x 100 mm	Ø 32 mm	4,3 kg
0062/10	€ 43,50	10 ton	230 mm	150 mm	80 mm	125 x 110 mm	Ø 40 mm	6,5 kg
0062/15	€ 64,20	15 ton	230 mm	150 mm	80 mm	140 x 135 mm	Ø 48 mm	8,4 kg
0062/20	€ 73,30	20 ton	242 mm	150 mm	60 mm	155 x 145 mm	Ø 53 mm	11 kg
0062/32	€ 141,00	32 ton	285 mm	180 mm	- mm	170 x 160 mm	Ø 56 mm	17,6 kg
0062/50	€ 242,00	50 ton	295 mm	180 mm	- mm	215 x 175 mm	Ø 85 mm	33 kg





0010

€ 674,00

LIFT TROLLEY

WITH FOLDABLE HANDLE, MECHANICAL BLOCKING SYSTEM OF THE PLATFORM, SWIVEL WHEELS WITH BRAKES



Capacity	500 kg
Table dimensions	850 x 500 x 50 mm
Lifting	290 ÷ 880 mm
Weight	91 kg



0075

€ 616,00

LIFT TROLLEY

WITH FOLDABLE HANDLE WITH MECHANICAL BLOCKING SYSTEM, SWIVEL WHEELS WITH BRAKES



Capacity	300 kg
Table dimensions	850 x 500 x 50 mm
Lifting	290 ÷ 880 mm
Weight	81 kg



0467

€ 798,00

HIGH LIFT TROLLEY

WITH DOUBLE SCISSOR ACTION, MECHANICAL BLOCKING SYSTEM OF THE PLATFORM, SWIVEL WHEELS WITH BRAKES



Capacity	350 kg
Table dimensions	910 x 500 x 53 mm
Lifting	335 ÷ 1300 mm
Weight	105 kg



C650

€ 142,00

THREE SHELVES TROLLEY

STRONG AND EASY TO ASSEMBLE, 2 SWIVEL AND 2 FIXED CASTERS



Overall sizes	800 x 450 x 800h mm
Steel thickness	2 mm
Wheels	ø 80 mm
Capacity	100 kg
Weight	23 kg

C750

€ 234,00

THREE SHELVES TROLLEY

STRONG AND EASY TO ASSEMBLE, 2 SWIVEL AND 2 FIXED CASTERS



Overall sizes	940 x 600 x 870h mm
Steel thickness	2,3 mm
Wheels	ø 150 mm
Capacity	200 kg
Weight	52 kg



C065/2

CAT. 42 € 150,00

PP TWO SHELVES TOOL CART

LIGHT WEIGHT, STRONG AND EASY TO ASSEMBLE, 2 SWIVEL AND 2 FIXED CASTERS



Overall sizes	1010 x 440 x 840h mm
Gross weight	16,7 kg
Wheels	ø 125 mm
Net weight	15,5 kg
Capacity	250 kg

C075/2

CAT. 42 € 197,00

PP TWO SHELVES TOOL CART

LIGHT WEIGHT, STRONG AND EASY TO ASSEMBLE, 2 SWIVEL AND 2 FIXED CASTERS



Overall sizes	1170 x 652 x 840h mm
Wheels	ø 125 mm
Capacity	250 kg
Gross weight	25 kg
Net weight	22,5 kg

C009

€ 316,00

CART WITH WOODEN SHELF

CART MADE OF STEEL, WITH 2 FIXED WHEELS AND 2 SWIVEL WHEELS WITH BRAKE



Overall dimensions	1000 x 800 x 750h mm
Steel thickness	2 mm
Plate thickness	36 mm
Wheels	ø 150 mm
Capacity	150 kg
Weight	60 kg

Cx

PVC PLATFORM TROLLEY

WITH FOLDABLE HANDLE, 2 FIXED CASTERS AND 2 SWIVEL CASTERS



Art.	€	Rubber wheels	Capacity	Platform dimensions	Height	Weight
C150	€ 55,70	Ø 100 mm	150 kg	700 x 450 mm	820 mm	7,8 kg
C300	€ 148,00	Ø 125 mm	300 kg	900 x 600 mm	890 mm	15,6 kg



C1102

€ 73,30

HAND TRUCK WITH PNEUMATIC WHEELS

FOR FLOWER POTS AND BOXES, SAFETY HANDLES, EPOXY PAINTING



Pneumatic wheels	Ø 260 x 85 mm
Capacity	200 kg
Toe plate dimensions	450 x 215 mm
Weight	8,5 kg

C189

€ 74,60

MULTIFUNCTION HAND TRUCK

WITH PNEUMATIC WHEELS FOR FIREPLACE WOOD, FLOWER POTS, BOXES AND OTHER OBJECTS. STRONG, EASY TO HANDLE AND VERSATILE.

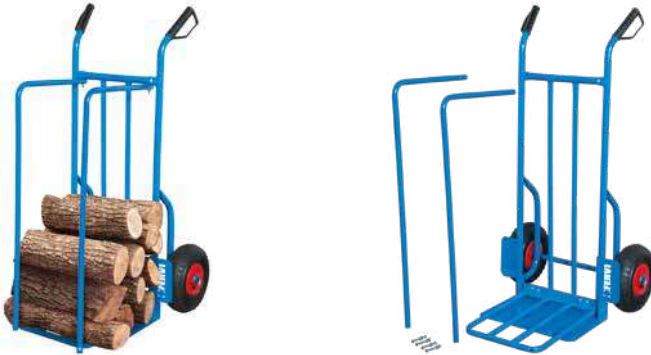

Pneumatic wheels	Ø 260 x 85 mm
Capacity	150 kg
Toe plate dimensions	400 x 250 mm
Movable grid	340 x 390 mm
Weight	11,5 kg

P019

€ 133,00

FOLDING ANTISLIP PLATFORM

ANTISLIP PROFESSIONAL, MADE OF ALUMINUM, EASY TO USE, SUITABLE FOR A WIDE RANGE OF ACTIVITIES IN DIFFERENT SECTORS, SUCH AS: HOME, AUTO AND OTHRES



Capacity	150 kg
Overall sizes	1260x380x500 mm
Platform dimensions	950x300 mm
Weight	7,5 kg

C182

€ 150,00

ALUMINUM HAND TRUCK WITH PNEUMATIC WHEELS



Pneumatic wheels	Ø 260 x 85 mm
Capacity	200 kg
Toe plate dimensions	300 x 205 mm
Weight	6,5 kg

0461

€ 16,40

POLYURETHANE WHEEL

260 X 85 mm NOT PIERCEABLE, WITH Ø 20 mm BEARING AND ADAPTER FROM 20 mm TO 18 mm, FOR HAND TRUCKS WITH 18-20 mm WHEEL SHAFT



Wheel sizes	250 x 75 mm
Hole sizes	ø 20 - 18 x 74 mm
Weight	1,1 kg

0056-

CHAIN HOIST



Art.	€	Capacity	Lifting	Weight
0056/1	€ 124,00	1000 kg	3000 mm	12 kg
0056/2	€ 184,00	2000 kg	3000 mm	22 kg

0237-

LEVER CHAIN HOIST



Art.	€	Capacity	Lifting	Weight
0237/05	€ 150,00	500 kg	1500 mm	5 kg
0237/15	€ 223,00	1500 kg	1500 mm	12 kg

0236

HOIST ARM

€ 73,00



Capacity	300 kg
Arm length	750 mm
Slot distance	380 mm
Section	45 X 45 mm ²



0602

HELECTRIC CABLE HOIST

€ 227,00

Capacity	200 / 400 kg
Cable length	18 m
Speeds	8 m/min
Single-phase motor	230 V 50 Hz 1 kW
Weight	16,7 kg

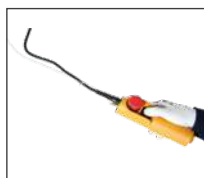

0600

CABLE HOIST

€ 253,00

Capacity	200 / 400 kg
Cable length	18 m
Speeds	8 m / min
Single-phase motor	230 V 50 Hz 0,75 kW
Weight	18 kg



Sx

MAGNETIC LIFTER

Neodimium

Art.	€	Lifting capacity	Round bar lifting cap.	Min-max lifting diameter	Dimensions	Weight
S0300	€ 458,00	300 kg	100 kg	50 + 300 mm	189 x 163 x 92 (B) mm	9,5 kg
S0600	€ 717,00	600 kg	200 kg	70 + 400 mm	267 x 198 x 129 (B) mm	19 kg
S1000	€ 1080,00	1000 kg	330 kg	75 + 450 mm	350 x 277 x 156 (B) mm	36 kg





PDC4-

CHAIN SLINGS

GRADE 80 ALLOY STEEL WITH SHORTENING HOOK, SECURITY FACTOR 4:1, EN 818-4, THE VERTICAL CAPACITY IS CALCULATED ON 3 ARMS ONLY BECAUSE THE FOURTH ARM IS NECESSARY ONLY TO EQUILIBRATE THE LOADING.

EN 818-4

Art.	€	Length	Capacity 0°β<math><45^\circ</math>	Capacity 45°β<math><60^\circ</math>	Chain	Hook
PDC4/7/2	€ 336,00	2000 mm	3150 kg	2240 kg	ø 7 mm	SLF
PDC4/7/3	€ 387,00	3000 mm	3150 kg	2240 kg	ø 7 mm	SLF
PDC4/7/4	€ 437,00	4000 mm	3150 kg	2240 kg	ø 7 mm	SLF
PDC4/10/2	€ 667,00	2000 mm	6700 kg	4750 kg	ø 10 mm	SLF
PDC4/10/3	€ 735,00	3000 mm	6700 kg	4750 kg	ø 10 mm	SLF
PDC4/10/4	€ 839,00	4000 mm	6700 kg	4750 kg	ø 10 mm	SLF



PDC2-

CHAIN SLINGS

GRADE 80 ALLOY STEEL, WITH SHORTENING HOOKS, SECURITY FACTOR 4:1

EN 818-4

Art.	€	Length	Capacity 0°β<math><45^\circ</math>	Capacity 45°β<math><60^\circ</math>	Chain	Hook
PDC2/7/2	€ 163,00	2000 mm	2120 kg	1500 kg	ø 7 mm	SLF
PDC2/7/3	€ 173,00	3000 mm	2120 kg	1500 kg	ø 7 mm	SLF
PDC2/7/4	€ 195,00	4000 mm	2120 kg	1500 kg	ø 7 mm	SLF
PDC2/10/2	€ 249,00	2000 mm	4250 kg	3150 kg	ø 10 mm	SLF
PDC2/10/3	€ 275,00	3000 mm	4250 kg	3150 kg	ø 10 mm	SLF
PDC2/10/4	€ 330,00	4000 mm	4250 kg	3150 kg	ø 10 mm	SLF



PDC1-

CHAIN SLINGS

GRADE 80 ALLOY STEEL, WITH SHORTENING HOOK, SECURITY FACTOR 4:1

EN 818-4

Art.	€	Length	Vertical capacity	Chain	Hook
PDC1/7/1	€ 66,10	1000 mm	1500 kg	ø 7 mm	SLF
PDC1/7/2	€ 75,50	2000 mm	1500 kg	ø 7 mm	SLF
PDC1/10/1	€ 98,70	1000 mm	3150 kg	ø 10 mm	SLF
PDC1/10/2	€ 116,00	2000 mm	3150 kg	ø 10 mm	SLF



AN2G/12/1

€ 70,20

2 STEEL ARMS PENDING

Rope	ø 12 mm
Length	1000 mm
Capacity	30° 2600 kg
Capacity	90° 2100 kg



06x

LASHING SYSTEM WITH POLYESTER RIBBON DRAFT

EN 12195-2

Art.	€	Strap ribbon with turnbuckle	Ribbon width	Capacity	Hooks
0635	€ 23,20	5,50 + 0,50 m	35 mm	1000 kg	2
0650	€ 32,40	8,00 + 0,50 m	50 mm	2000 kg	2
0675	€ 163,00	10,00 + 1,00 m	75 mm	3000 kg	2



0635/25

€ 11,30

LASHING SYSTEM WITH POLYESTERE RIBBON DRAFT



EN 12195-2

Strap ribbon mm 25 with turnbuckle and 2 hooks	4,00 + 0,30 m
Capacity	250 kg

0117

€ 11,40

2-PC PLASTIC PROTECTIONS

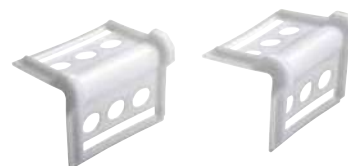

Overall sizes	135 x 125 mm
---------------	--------------

x-1000

POLYESTER COLORED SLINGS

DOUBLE LAYER BAND LIFTING SYSTEM, SECURITY FACTOR 7:1

Art.	€	m	Breadth	Color	Eye length	Vertical capacity	Capacity basket	Basket capacity β 45° kg	Basket capacity β 60° kg	Capacity choker
1/1000	€ 11,20	1	50 mm	Purple	250 mm	1000 kg	2000 kg	1400	1000	800 kg
2/1000	€ 15,00	2	50 mm	Purple	250 mm	1000 kg	2000 kg	1400	1000	800 kg
3/1000	€ 17,80	3	50 mm	Purple	250 mm	1000 kg	2000 kg	1400	1000	800 kg
4/1000	€ 21,50	4	50 mm	Purple	250 mm	1000 kg	2000 kg	1400	1000	800 kg



x-2000

POLYESTER COLORED SLINGS

DOUBLE LAYER BAND LIFTING SYSTEM, SECURITY FACTOR 7:1

Art.	€	m	Breadth	Color	Eye length	Vertical capacity	Capacity basket	Basket capacity β 45° kg	Basket capacity β 60° kg	Capacity choker
1/2000	€ 14,40	1	60 mm	Green	250 mm	2000 kg	4000 kg	2800	2000	1600 kg
2/2000	€ 20,60	2	60 mm	Green	250 mm	2000 kg	4000 kg	2800	2000	1600 kg
3/2000	€ 26,80	3	60 mm	Green	250 mm	2000 kg	4000 kg	2800	2000	1600 kg
4/2000	€ 32,40	4	60 mm	Green	250 mm	2000 kg	4000 kg	2800	2000	1600 kg
5/2000	€ 40,80	5	60 mm	Green	250 mm	2000 kg	4000 kg	2800	2000	1600 kg
6/2000	€ 47,70	6	60 mm	Green	250 mm	2000 kg	4000 kg	2800	2000	1600 kg



x-3000

POLYESTER COLORED SLINGS

DOUBLE LAYER BAND LIFTING SYSTEM, SECURITY FACTOR 7:1

Art.	€	m	Breadth	Color	Eye length	Vertical capacity	Capacity basket	Basket capacity β 45° kg	Basket capacity β 60° kg	Capacity choker
1/3000	€ 19,70	1	90 mm	Yellow	300 mm	3000 kg	6000 kg	4200	3000	2400 kg
2/3000	€ 27,80	2	90 mm	Yellow	300 mm	3000 kg	6000 kg	4200	3000	2400 kg
3/3000	€ 38,90	3	90 mm	Yellow	300 mm	3000 kg	6000 kg	4200	3000	2400 kg
4/3000	€ 47,70	4	90 mm	Yellow	300 mm	3000 kg	6000 kg	4200	3000	2400 kg
5/3000	€ 55,00	5	90 mm	Yellow	300 mm	3000 kg	6000 kg	4200	3000	2400 kg
6/3000	€ 64,20	6	90 mm	Yellow	300 mm	3000 kg	6000 kg	4200	3000	2400 kg



FTx-1000

POLYESTER ROUND SLINGS

EXTERNAL SLEEVE SECURITY FACTOR 7:1

Art.	€	Ring	Color	Vertical	Capacity basket	Basket capacity β 45° kg	Basket capacity β 60° kg	Capacity choker
FT1/1000	€ 5,70	1 m	Purple	1000 kg	2000 kg	1400	1000	800 kg
FT2/1000	€ 8,00	2 m	Purple	1000 kg	2000 kg	1400	1000	800 kg
FT3/1000	€ 11,30	3 m	Purple	1000 kg	2000 kg	1400	1000	800 kg
FT4/1000	€ 14,50	4 m	Purple	1000 kg	2000 kg	1400	1000	800 kg
FT5/1000	€ 17,80	5 m	Purple	1000 kg	2000 kg	1400	1000	800 kg
FT6/1000	€ 21,20	6 m	Purple	1000 kg	2000 kg	1400	1000	800 kg



FTx-2000

POLYESTER ROUND SLINGS

EXTERNAL SLEEVE SECURITY FACTOR 7:1

Art.	€	Ring	Color	Vertical	Capacity basket	Basket capacity β 45° kg	Basket capacity β 60° kg	Capacity choker
FT1/2000	€ 8,00	1 m	Green	2000 kg	4000 kg	2800	2000	1600 kg
FT2/2000	€ 9,90	2 m	Green	2000 kg	4000 kg	2800	2000	1600 kg
FT3/2000	€ 16,60	3 m	Green	2000 kg	4000 kg	2800	2000	1600 kg
FT4/2000	€ 21,00	4 m	Green	2000 kg	4000 kg	2800	2000	1600 kg
FT5/2000	€ 23,30	5 m	Green	2000 kg	4000 kg	2800	2000	1600 kg
FT6/2000	€ 27,80	6 m	Green	2000 kg	4000 kg	2800	2000	1600 kg



FTx-3000

POLYESTER ROUND SLINGS

EXTERNAL SLEEVE SECURITY FACTOR 7:1

Art.	€	Ring	Color	Vertical	Capacity basket	Basket capacity β 45° kg	Basket capacity β 60° kg	Capacity choker
FT1/3000	€ 9,90	1 m	Yellow	3000 kg	6000 kg	4200	3000	2400 kg
FT2/3000	€ 14,60	2 m	Yellow	3000 kg	6000 kg	4200	3000	2400 kg
FT3/3000	€ 21,00	3 m	Yellow	3000 kg	6000 kg	4200	3000	2400 kg
FT4/3000	€ 27,30	4 m	Yellow	3000 kg	6000 kg	4200	3000	2400 kg
FT5/3000	€ 31,90	5 m	Yellow	3000 kg	6000 kg	4200	3000	2400 kg
FT6/3000	€ 40,00	6 m	Yellow	3000 kg	6000 kg	4200	3000	2400 kg





0791-

WIRE ROPE PULLING HOIST

FOR PULLING AND LIFTING



Art.	€	Max load	Cable	Weight
0791/08	€ 295,00	800 kg	ø 8,3mm x 20m	11 kg
0791/16	€ 398,00	1600 kg	ø 11mm x 20m	27 kg
0791/32	€ 779,00	3200 kg	ø 16mm x 20m	50 kg

0070/C

€ 36,20

GEARED HAND WINCH

ZINC-PLATED



Max load	500 kg
Throat width	50 mm
Max ø wheel	133 mm
Min. ø wheel	40 mm
Cable size	ø 4,5 mm x 10 m
Base dimensions	140 x 90 mm

0066

€ 27,60

DOUBLE RATCHET HAND PULLER



Max load	800 kg
Cable diameter	ø 5 mm
Max length	2 m
Weight	2,7 kg

0070

€ 27,90

GEARED HAND WINCH

ZINC-PLATED



Max load	500 kg
Throat width	50 mm
Max ø wheel	133 mm
Min. ø wheel	40 mm
Cable size	-
Base dimensions	140 x 90 mm

0590

€ 58,50

HAND OPERATED WINCH WITH BRAKE



Max load	450 kg
Throat width	49 mm
Max ø wheel	110 mm
Min. ø wheel	45 mm
Overall dimensions without handle	170 x 150 x 125h mm
Weight	2,7 kg

0654-xL

TRANSPORT TROLLEY

WITH NYLON WHEELS AND HOOK FOR TOWING



Art.	€	Capacity	Working height	Roller dimensions	Wheels	Table dimensions	Handle length	Handle swivel range	Dimensions	Weight
0654/06L	€ 451,00	6 Ton	110 mm	85 x 85 mm	8	Ø 170 mm	1080 mm	±90°	610 x 520 mm	41 kg
0654/09L	€ 506,00	9 Ton	110 mm	85 x 85 mm	12	Ø 170 mm	1080 mm	±90°	840 x 583 mm	59 kg
0654/12L	€ 704,00	12 Ton	110 mm	85 x 85 mm	16	Ø 170 mm	1080 mm	±90°	1030 x 620 mm	80 kg

0654-xF

TRANSPORT TROLLEY

WITH NYLON WHEELS



Art.	€	Capacity	Working height	Roller dimensions	Wheels each trolley	Table dimensions	Lever bar length	Weight
0654/06F	€ 307,00	6 Ton	110 mm	85 x 85 mm	4	200 x 220 mm	640 ÷ 1030 mm	30 kg
0654/09F	€ 411,00	9 Ton	110 mm	85 x 85 mm	6	200 x 320 mm	840 ÷ 1230 mm	43 kg
0654/12F	€ 468,00	12 Ton	110 mm	85 x 85 mm	8	200 x 407 mm	1104 ÷ 1430 mm	52 kg

0068/S

€ 2770,00

TRUCK PALLET WITH SCALE AND PRINTER

NOT LEGAL FOR TRADE - TARE FUNCTION POWERED BY RECHARGEABLE BATTERY
- POLYURETHANE TIRE

Capacity	2000 kg
Weight capacity	2000 kg
Fork height	88 ÷ 200 mm
Fork dimensions	1150 x 568 mm
Reading	1 kg
Accuracy	±2 kg
Printer	Si/Yes
Front wheel	Doppia/Double
Weight	155 kg



0068L

€ 1850,00

TRUCK PALLET WITH SCALE

TRUCK PALLET WITH SCALE NOT LEGAL FOR TRADE - TARE FUNCTION POWERED BY
REPLACEABLE BATTERIES

Capacity	2000 kg
Weight capacity	2000 kg
Fork height	85 ÷ 175 mm
Fork dimensions	1150 x 570 mm
Reading	0,5 kg
Accuracy	±0,05% kg
Front wheel	Double
Weight	125 kg





0028R

CAT. 42 € 542,00

LOWERED MANUAL PALLET TRUCK

WITH POLYURETHANE WHEELS

Capacity	2500 kg
Fork height	63 ÷ 165 mm
Fork dimensions	1150 x 540 mm
Armor plate thickness	3 mm
Front wheel	Double
Weight	72 kg



€ 472,00

0028

MANUAL TRUCK -PALLET

POLYURETHANE

Capacity	2500 kg
Fork height	85 ÷ 200 mm
Fork dimensions	1150 x 540 mm
Armor plate thickness	3 mm
Front wheel	Double
Weight	72 kg



€ 545,00

0064

MANUAL TRUCK -PALLET

POLYURETHANE

Capacity	2500 kg
Fork height	85 ÷ 200 mm
Fork dimensions	900 x 540 mm
Armor plate thickness	3 mm
Front wheel	Single
Weight	64 kg



€ 937,00

S2/800

HIGH LIFT TRUCK-PALLET

SCISSORS

Capacity	1000 kg
Fork height	85 ÷ 800 mm
Fork dimensions	1170 x 540 mm
Tire	Polyurethane
Front wheel	Single
Weight	117 kg



0782

€ 893,00

PLATFORM STACKER WITH FORKS



Capacity	400 kg
Fork height	85 ÷ 1500 mm
Fork dimensions	545 x 650 mm
Platform	576 x 650 mm
Mobile wheels	Ø 127 x 40 mm
Fix wheels	Ø 75 x 40 mm
Tire	Polyurethane
Overall sizes	1100 x 600 x 1725h mm
Weight	90 kg



0143A

CAT. 42 € 1510,00

MANUAL STACKER

WITH BRAKE AND LIFTING FOOT PEDAL

Capacity	1000 kg
Fork height	90 ÷ 1600 mm
Fork dimensions	1150 x 550 mm
Upright height	2100 mm
Tire	Polyurethane
Front wheel	Double
Dimensions	920 x 1670 x 2100h mm
Weight	210 kg



0143/25

CAT. 42 € 1670,00

MANUAL STACKER

WITH BRAKE AND LIFTING FOOT PEDAL

Capacity	1000 / 800 kg
Fork height	75 ÷ 1600 ÷ 2500 mm
Fork dimensions	1150 x 550 mm
Upright height	1840 mm
Tire	Polyurethane
Front wheel	Double
Dimensions	1670 x 920 x 1840h mm
Weight	306 kg



C030-

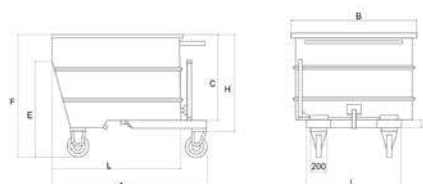

SCRAP DUMPING CONTAINER EQUIPPED WITH WHEELS





Art.	€	Liters	A	B	C	E	F	H	I	L	Capacity	Wheels	Wheels	Color	Weight
C030/0300	€ 1200,00	300	1280 mm	820 mm	395 mm	530 mm	650 mm	490 mm	700 mm	1010 mm	600 kg	Ø 125 mm	165h mm	RAL6011	95 kg
C030/0500	€ 1360,00	500	1280 mm	920 mm	600 mm	750 mm	915 mm	710 mm	800 mm	1010 mm	1000 kg	Ø 180 mm	210h mm	RAL6011	130 kg
C030/0750	€ 1500,00	750	1280 mm	1070 mm	730 mm	800 mm	1035 mm	830 mm	800 mm	1055 mm	1350 kg	Ø 180 mm	210h mm	RAL6011	150 kg
C030/1000	€ 1610,00	1000	1510 mm	1070 mm	870 mm	925 mm	1220 mm	975 mm	800 mm	1255 mm	1700 kg	Ø 200 mm	245h mm	RAL6011	182 kg
C030/1350	€ 1860,00	1350	1510 mm	1320 mm	870 mm	925 mm	1220 mm	975 mm	800 mm	1255 mm	2000 kg	Ø 200 mm	245h mm	RAL6011	205 kg









 **MACHINE VICES**

- pag.142*  — Precision vices
- pag.143*  — Vices

 **TABLES AND DIVIDERS**

- pag.147*  — Dividers
- pag.151*  — Working tables and magnetic chucks
- pag.154*  — Clamping



 **CHUCKS AND LIVE CENTERS**

- pag.155*  — Live centers
- pag.156*  — Keyless and self-centering chucks
- pag.161*  — Tapping chucks
- pag.162*  — Arbor for milling cutters
- pag.166*  — Morse taper adapters and collet chucks
- pag.168*  — Tool cabinets
- pag.169*  — Boring head

 **TOOL POSTS AND TOOL HOLDERS**

- pag.170*  — Tool posts

 **MACHINERY ACCESSORIES**

- pag.172*  — Pumps and accessories
- pag.173*  — Machine tool safety guards
- pag.174*  — Lamps

 **TOOLS FOR TURNING AND MILLING**

- pag.175*  — External tool holders
- pag.178*  — Internal tool holders
- pag.186*  — Milling cutters

M061

€ 360,00

ANGLE PRECISION VICE

Length	235 mm
Jaw width	88 mm
Pins center distance	100 mm
Jaw height	40 mm
Opening	120 mm
Accuracy	0,005 mm
Tilting	0° ÷ 45°
Weight	12,5 kg



M012-

PRECISION MEASURING MILLING VICE

Art.	€	Dimensions	Opening	Jaw height	Accuracy	Weight
M012/038	€ 72,30	38 x 105 x 45h mm	44 mm	25 mm	0,005 mm	1,3 kg
M012/050	€ 75,50	50 x 140 x 50h mm	65 mm	25 mm	0,005 mm	2 kg
M012/080	€ 183,00	73 x 190 x 67h mm	110 mm	35 mm	0,005 mm	4 kg
M012/100	€ 255,00	100 x 245 x 90h mm	125 mm	45 mm	0,005 mm	9,3 kg

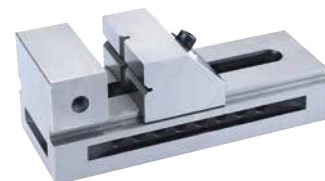

M011-

HIGH PRECISION STEEL VICE

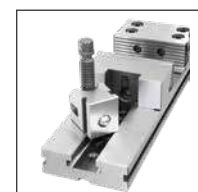
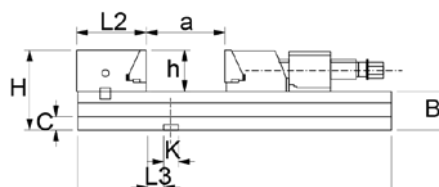
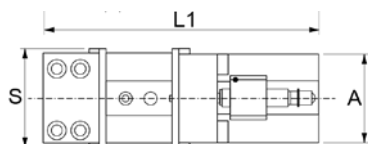
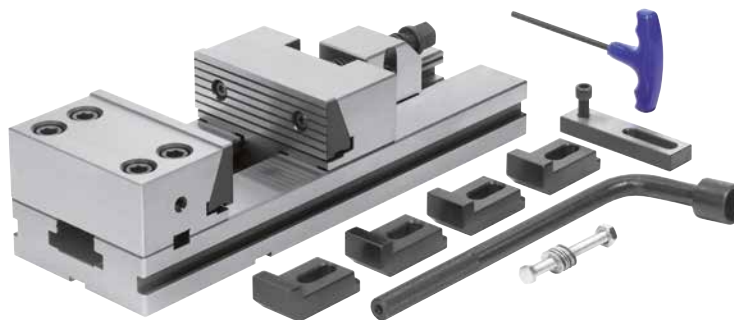

Art.	€	Jaw dimensions	Accuracy	S	A	B	C	H	L1	L2	L3	h	K h7	a	Hardness	Weight
M011/125/150	€ 893,00	125 x 50h mm	0,02 mm	125 mm	125 mm	40 mm	15 mm	90 mm	350 mm	80 mm	25,6 mm	50 mm	16 mm	150 mm	58 - 63 HRC	20 kg
M011/150/210	€ 1030,00	150 x 60h mm	0,02 mm	150 mm	150 mm	50 mm	20 mm	110 mm	435 mm	93 mm	25,6 mm	60 mm	16 mm	210 mm	58 - 63 HRC	36 kg
M011/150/300	€ 1280,00	150 x 60h mm	0,02 mm	150 mm	150 mm	50 mm	20 mm	110 mm	525 mm	93 mm	25,6 mm	60 mm	16 mm	300 mm	58 - 63 HRC	40 kg

M011-xG

SPARE PART JAWS

Art.	€	Description	Jaw dimensions
M011/125GP	€ 191,00	Prismatic jaw	125 x 40h mm
M011/125GR	€ 321,00	Pair of striped jaws	125 x 40h mm
M011/150GP	€ 230,00	Prismatic jaw	150 x 45h mm
M011/150GR	€ 343,00	Pair of striped jaws	150 x 45h mm



M028-

HIGH PRECISION STEEL MODULAR VICE

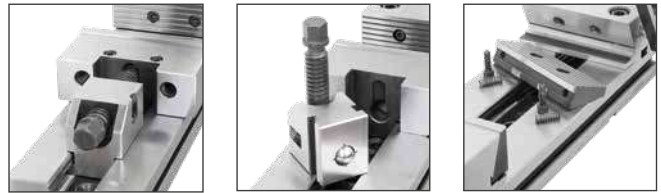
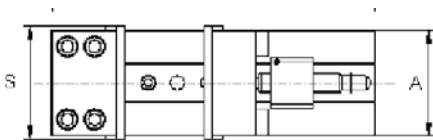
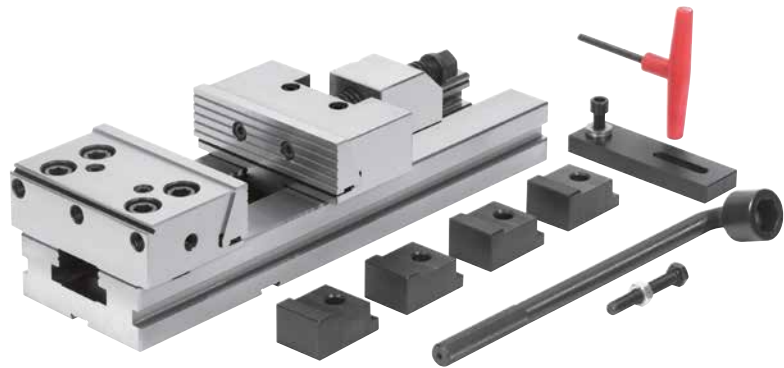
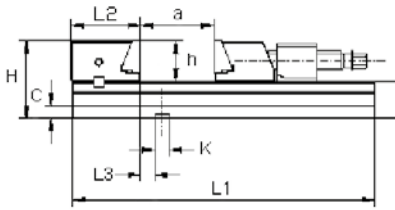

Art.	€	Jaw dimensions	Accuracy	S	A	B	C	H	L1	L2	L3	h	K h7	a	Hardness	Weight
M028/100/100	€ 641,00	100 x 30h mm	0,02 mm	100 mm	75 mm	35 mm	15 mm	65 mm	270 mm	77,9 mm	25,6 mm	30 mm	16 mm	100 mm	58 - 62 HRC	7 kg
M028/125/150	€ 697,00	125 x 40h mm	0,02 mm	125 mm	95 mm	40 mm	15 mm	80 mm	345 mm	77,9 mm	25,6 mm	40 mm	16 mm	150 mm	58 - 62 HRC	13 kg
M028/150/200	€ 831,00	150 x 50h mm	0,02 mm	150 mm	125 mm	50 mm	20 mm	100 mm	420 mm	89,4 mm	25,6 mm	50 mm	16 mm	200 mm	58 - 62 HRC	26 kg
M028/150/300	€ 893,00	150 x 50h mm	0,02 mm	150 mm	125 mm	50 mm	20 mm	100 mm	520 mm	89,4 mm	25,6 mm	50 mm	16 mm	300 mm	58 - 62 HRC	30 kg
M028/150/400	€ 1030,00	150 x 50h mm	0,02 mm	150 mm	125 mm	50 mm	20 mm	100 mm	620 mm	89,4 mm	25,6 mm	50 mm	16 mm	400 mm	58 - 62 HRC	34 kg
M028/175/200	€ 1030,00	175 x 60h mm	0,02 mm	175 mm	145 mm	58 mm	20 mm	118 mm	455 mm	96,9 mm	25,6 mm	60 mm	16 mm	200 mm	58 - 62 HRC	51 kg
M028/175/300	€ 1060,00	175 x 60h mm	0,02 mm	175 mm	145 mm	58 mm	20 mm	118 mm	555 mm	96,9 mm	25,6 mm	60 mm	16 mm	300 mm	58 - 62 HRC	43 kg
M028/175/400	€ 1190,00	175 x 60h mm	0,02 mm	175 mm	145 mm	58 mm	20 mm	118 mm	655 mm	96,9 mm	25,6 mm	60 mm	16 mm	400 mm	58 - 62 HRC	51 kg
M028/175/500	€ 1330,00	175 x 60h mm	0,02 mm	175 mm	145 mm	58 mm	20 mm	118 mm	755 mm	96,9 mm	25,6 mm	60 mm	16 mm	500 mm	58 - 62 HRC	59 kg
M028/200/300	€ 1600,00	200 x 65h mm	0,02 mm	200 mm	170 mm	70 mm	26 mm	135 mm	595 mm	113,4 mm	25,6 mm	65 mm	16 mm	300 mm	58 - 62 HRC	80 kg
M028/200/400	€ 1640,00	200 x 65h mm	0,02 mm	200 mm	170 mm	70 mm	26 mm	135 mm	695 mm	113,4 mm	25,6 mm	65 mm	16 mm	400 mm	58 - 62 HRC	71 kg
M028/200/500	€ 1980,00	200 x 65h mm	0,02 mm	200 mm	170 mm	70 mm	26 mm	135 mm	795 mm	113,4 mm	25,6 mm	65 mm	16 mm	500 mm	58 - 62 HRC	79 kg
M028/200/600	€ 2180,00	200 x 65h mm	0,02 mm	200 mm	170 mm	70 mm	26 mm	135 mm	895 mm	113,4 mm	25,6 mm	65 mm	16 mm	600 mm	58 - 62 HRC	84 kg

M028-xG

SPARE PART JAWS

Art.	€	Description	Jaw dimensions
M028/100GP	€ 184,00	Prismatic jaw	100 x 24,5h mm
M028/175GP	€ 230,00	Prismatic jaw	175 x 43h mm
M028/200GP	€ 255,00	Prismatic jaw	200 x 53h mm
M028M029/125GP	€ 192,00	Prismatic jaw	125 x 32h mm
M028M029/150GP	€ 207,00	Prismatic jaw	150 x 40h mm



M023-

MILLING MACHINE VICE WITH 360° SWIVEL BASE



Art.	€	Jaws	Opening	Overall sizes	Base dimensions	Slot distance	Slot	Weight
M023/100	€ 179,00	100 x 35 mm	80 mm	270 x 130 x 105h mm	215 X 165 mm	195 mm	14 mm	11 kg
M023/125	€ 214,00	125 x 40 mm	100 mm	355 x 190 x 127h mm	215 X 165 mm	195 mm	14 mm	17 kg
M023/160	€ 290,00	160 x 50 mm	125 mm	422 x 235 x 162h mm	300 X 235 mm	275 mm	18 mm	32 kg
M023/200	€ 365,00	200 x 61 mm	160 mm	490 x 270 x 175h mm	300 X 235 mm	275 mm	18 mm	50 kg

M024-

MILLING MACHINE VICE WITH 360° SWIVEL BASE

M024/250



Art.	€	Jaws	Opening	Overall sizes	Base dimensions	Slot distance	Slot	Weight
M024/136	€ 155,00	136 x 32 mm	170 mm	375 x 162 x 123h mm	223 x 165 mm	200 mm	14 mm	14 kg
M024/160	€ 223,00	160 x 50 mm	180 mm	402 x 182 x 142h mm	252 x 182 mm	225 mm	14 mm	23 kg
M024/200	€ 294,00	200 x 63 mm	220 mm	470 x 234 x 172h mm	290 x 222 mm	260 mm	18 mm	33 kg
M024/250	€ 427,00	250 x 45 mm	320 mm	612 x 280 x 186h mm	290 x 270 mm	245 mm	18 mm	66 kg

M530-

TILTING MILLING MACHINE VICE WITH 360° SWIVEL BASE

Art.	€	Jaws	Opening	Overall sizes	Base dimensions	Slot distance	Slot	Weight
M530/100	€ 268,00	100 x 32 mm	90 mm	325 x 180 x 150h mm	250 x 180 mm	230 mm	14 mm	19 kg
M530/125	€ 318,00	125 x 40 mm	100 mm	360 x 206 x 165h mm	290 x 226 mm	260 mm	18 mm	26 kg
M530/160	€ 390,00	160 x 50 mm	125 mm	443 x 270 x 194h mm	- mm	- mm	- mm	35 kg



P014

STEEL PARALLEL COUPLE SET
HARDENED AND GROUND PRECISION

€ 268,00

28 Pcs Wooden box



Overall sizes	150 x 10 x (14-16-18-20-22-24-26-28-30-32-35-40-45-50) mm
Hardness	HRC 60
Accuracy	± 0,005 mm
Pieces	28

P015

STEEL PARALLEL COUPLE SET
HARDENED AND GROUND PRECISION

€ 146,00

18 Pcs Wooden box



Overall sizes	160 x 4 x (10-14-18-22-26-30-34-38-42) mm
Hardness	HRC 60
Accuracy	± 0,005 mm
Pieces	18

P017

€ 103,00

STEEL PARALLEL COUPLE SET

HARDENED AND GROUND PRECISION



18 Pcs Plastic box

Overall sizes	150 x 8 x (14-16-20-24-30-32-36-40-44) mm
Hardness	HRC 45
Pieces	18
Weight	4,9 kg

M027-

*CAT. 42

DRILL PRESS VICE

EQUIPPED WITH SCRAPPED GROOVES



Art.	€	Jaws	Opening	Base dimensions	Packing dimensions	Weight
M027/100	€ 133,00	100 x 44 mm	110 mm	290 x 170 mm	400 x 220 x 120 mm	8,5 kg
M027/140	€ 187,00	140 x 44 mm	140 mm	335 x 220 mm	500 x 290 x 150 mm	11,0 kg
M027/200	€ 303,00	200 x 60 mm	200 mm	430 x 280 mm	640 x 360 x 170 mm	20,0 kg

M001-

DRILL PRESS VICE



Art.	€	Jaws	Opening	Weight
M001/100	€ 50,00	100 mm	80 mm	4,2 kg
M001/120	€ 61,40	120 x 33,5 mm	110 mm	6,2 kg
M001/150	€ 77,00	150 mm	135 mm	7,5 kg

0142-

DRILL PRESS VICE



Art.	€	Jaws	Slot distance	Vice opening	Slot size	Weight
0142/75	€ 17,30	75 X 24 mm	95 mm	55 mm	9 mm	1,8 kg
0142/100	€ 24,50	100 x 25,5 mm	125 mm	85 mm	12 mm	2,8 kg
0142/125	€ 30,50	125 x 30 mm	140 mm	100 mm	13 mm	4,4 kg

0698/100

€ 77,40

TILTING VICE



Jaws	105 x 47 mm
Opening	105 mm
Holes	0°-15°-30°-45°-60°-75°-90°
Base	192 x 185 mm
Slot distance	160 mm
Overall sizes	192 x 185 x 115h mm
Weight	8,5 kg

M034/120

€ 239,00

QUICK ACTING DRILL PRESS VICE
WITH PRISMATIC JAW AND SWIVEL BASE

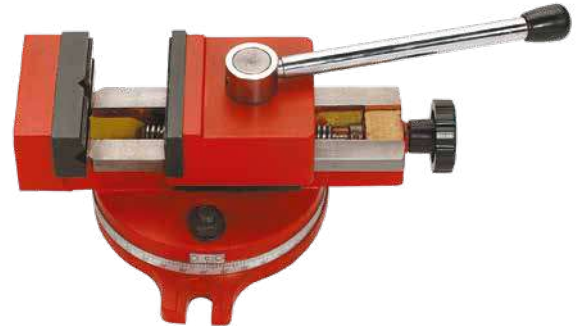

Jaws	120 x 40 mm
Opening	120 mm
Weight	7 kg

0188-

2 - WAY CROSS VICE

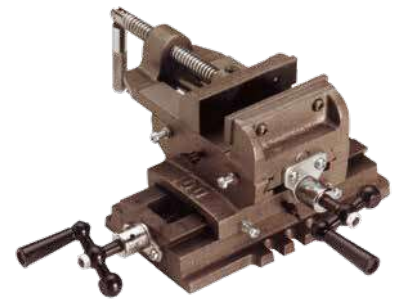

Art.	€	Jaws	Opening	Base dimensions	Height	Longitudinal travel	Cross travel	Weight
0188/100	€ 72,70	100 x 25 mm	90 mm	240 x 140 mm	140 mm	130 mm	110 mm	7,5 kg
0188/125	€ 103,00	125 x 40 mm	110 mm	255 x 160 mm	150 mm	170 mm	130 mm	13 kg
0188/150	€ 130,00	150 x 40 mm	145 mm	280 x 170 mm	160 mm	160 mm	180 mm	15 kg

0188-xG

***CAT. 42**

2 - WAY CROSS VICE WITH SWIVEL BASE



Art.	€	Jaws	Opening	Base dimensions	Height	Longitudinal travel	Cross travel	Weight
0188/100G	€ 123,00	100 X 25 mm	90 mm	210 x 150 mm	175 mm	130 mm	110 mm	12 kg
0188/125G	€ 139,00	125 X 40 mm	120 mm	230 x 175 mm	180 mm	150 mm	120 mm	15 kg
0188/150G	€ 158,00	150 X 45 mm	150 mm	235 x 195 mm	190 mm	170 mm	115 mm	22 kg

D023

€ 1500,00

HORIZONTAL AND VERTICAL RATCHET DIVIDING HEAD

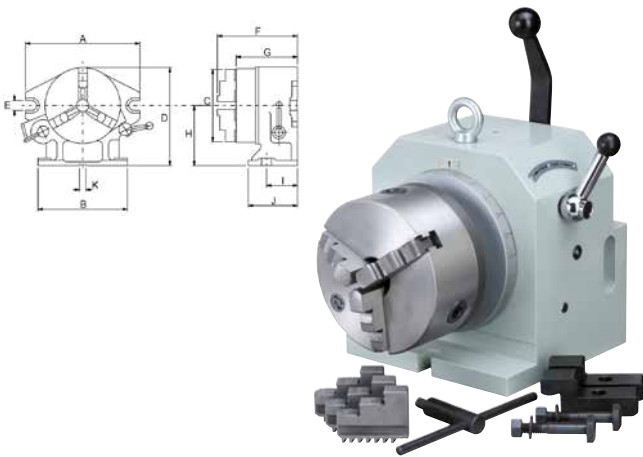

Dividing	2 - 3 - 4 - 6 - 8 - 12 - 24
A	230 mm
B	230 mm
C	160 mm
D	236 mm
E	18 mm
F	320 mm
G	285 mm
H	125 mm
I	- mm
J	210 mm
K	18 mm
Hole	30 mm
Hor. max load	50 kg
Ver. max load	10 kg
Weight	66,5 kg

D003

€ 1180,00

HORIZONTAL AND VERTICAL DIRECT DIVIDING HEAD

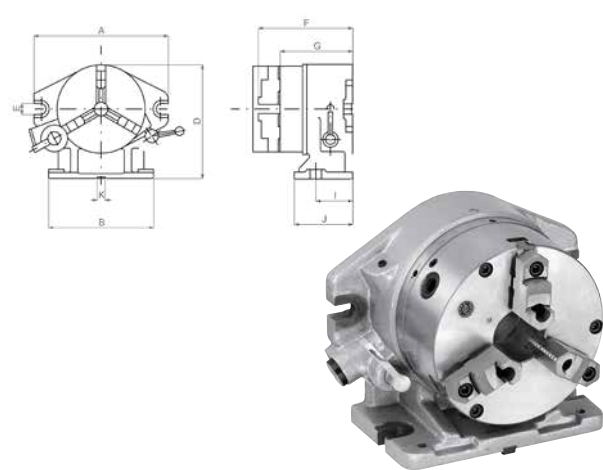

A	310 mm
B	255 mm
C	210 mm
D	259,25 mm
E	18 mm
F	214 mm
G	171,5 mm
H	149,25 mm
I	80 mm
J	130 mm
K	16 mm
Hole	62 mm
Hor. max load	50 kg
Ver. max load	10 kg
Dividing	2 - 3 - 4 - 6 - 8 - 12 - 24
Weight	52 kg

T016/100

CAT. 42 € 350,00

TILTING ROTARY TABLE

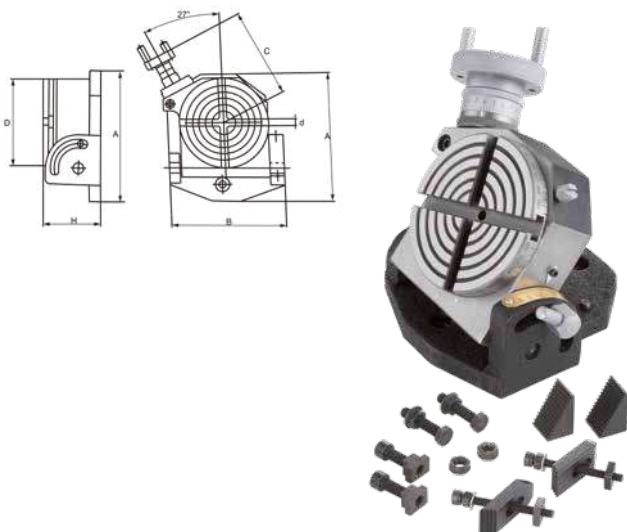

A	143 mm
B	130 mm
C	105 mm
D	102 mm
d	18 mm
H	68 mm
Revolution	360°
Tilting table	90°
Ratio	1:36
Slots	4 x 6.35 mm 5/16" N° / mm
Horizontal height	102 mm

T017/100

CAT. 42 € 500,00

TILTING ROTARY TABLE WITH CHUCK

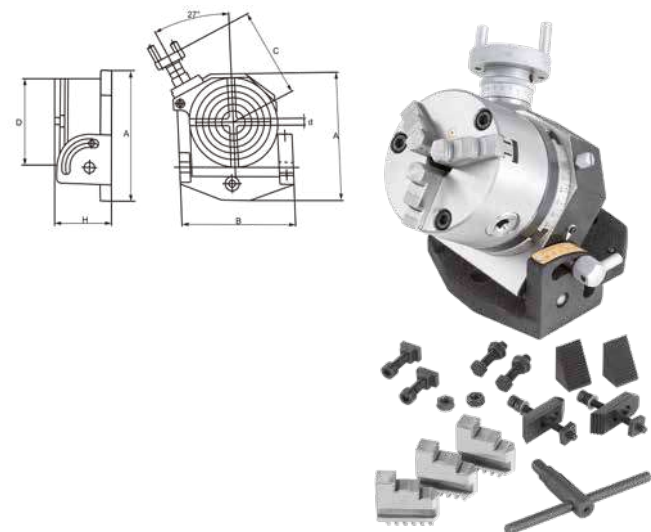

Chuck sizes	100 mm
A	143 mm
B	130 mm
C	105 mm
D	102 mm
d	18 mm
H	68 mm
Revolution	360°
Tilting table	90°
Ratio	1:36
Slots	4 x 6.35 mm 5/16" N° / mm
Horizontal height	102 mm



T001-

0° ÷ 90° TILTING ROTARY TABLE

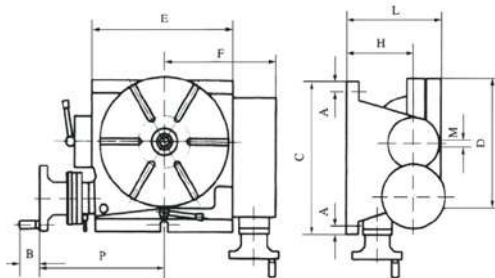

Art.	€	A	B	C	D	E	F	G	H	L	MT	Ratio	Reading	Slots	Hor. max load	Ver. max load	Weight
T001/250	€ 2010,00	14 mm	40 mm	310 mm	250 mm	252 mm	199 mm	14 mm	140 mm	205 mm	3	1:90	10"	6/12 N° / mm	200 kg	100 kg	78 kg
T001/320	€ 2210,00	16 mm	40 mm	380 mm	320 mm	322 mm	241 mm	18 mm	185 mm	257 mm	4	1:90	10"	6/14 N° / mm	250 kg	125 kg	133 kg

T012-

HORIZONTAL ROTARY TABLE

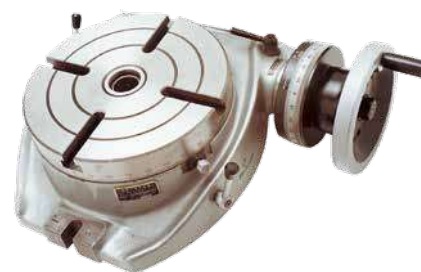
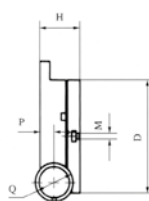
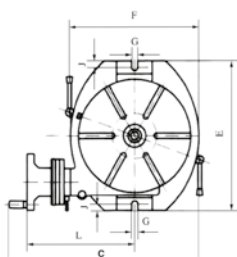

Art.	€	C	D	E	F	G	H	J	L	MT	P	Q	Reading	Ratio	Slots	Capacity	Weight
T012/500	€ 3150,00	753 mm	500 mm	640 mm	560 mm	22 mm	158,5 mm	20 mm	393 mm	5	65 mm	180 mm	10"	1:120	8/18 N° / mm	550 kg	238 kg
T012/630	€ 6620,00	898 mm	630 mm	820 mm	700 mm	22 mm	160 mm	20 mm	468 mm	5	68 mm	220 mm	10"	1:120	8/18 N° / mm	700 kg	345 kg

D005-

DIVIDING PLATES FOR ROTARY TABLE



Art.	€	For rotary table	Ratio	Plates holes	Hole	External
D005	€ 181,00	T001/250 - 320, T002/160 - 320	1:90	A: 34-37-38-39-41-43-44-50-52-56-6, B: 46-47-49-51-53-54-57-58-59-62-64	38 mm	130 mm
D005/100	€ 55,30	T002/100	1:72	A:10	29 mm	90 mm
D005/400	€ 203,00	T002/400	1:90	A: 34-37-38-39-41-43-44-50-52-56-61, B: 46-47-49-51-53-54-57-58-59-62-64	53 mm	170 mm
D005/500	€ 269,00	T012/500 T012/630	1:120	A: 33-34-37-38-39-41-43-44-50-52-56-61, B: 46-47-49-51-53-54-57-58-59-62-63-64	53 mm	170 mm



T002-

HORIZONTAL AND VERTICAL ROTARY TABLE

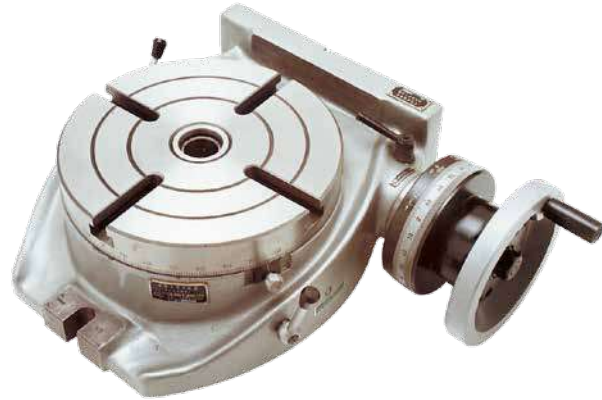
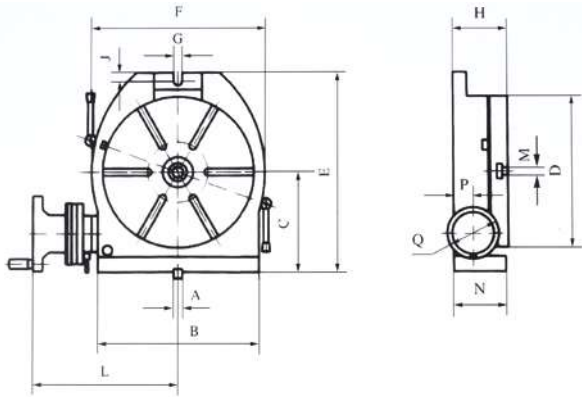

Art.	€	A	B	C	D	E	F	G	H	J	L	MT	N	P	Q	Reading	Ratio	Slots	Hor. max load	Ver. max load	Weight
T002/100	€ 496,00	10	125	70	100	125	125	0	70	0	104	2	48	30	50	10"	1:72	4/6 N° / mm	20 kg	10 kg	7 kg
T002/160	€ 624,00	12	186	125	160	242	196	12	85	12	194	2	82	37	125	10"	1:90	4/10 N° / mm	100 kg	50 kg	23 kg
T002/200	€ 728,00	14	208	150	200	285	236	14	100	15	211	3	99	48	125	10"	1:90	4/12 N° / mm	150 kg	75 kg	30,5 kg
T002/250	€ 770,00	14	253	170	250	328	286	14	110	16	241	4	106	48	125	10"	1:90	6/12 N° / mm	200 kg	100 kg	44 kg
T002/320	€ 1240,00	18	321	210	320	410	360	18	120	16	273	4	118	48	125	10"	1:90	6/14 N° / mm	250 kg	125 kg	75 kg
T002/400	€ 1730,00	18	400	260	400	525	450	18	150	16	337	4	145	70	160	10"	1:90	6/14 N° / mm	300 kg	150 kg	174 kg

C054

€ 184,00

ADJUSTABLE TAILSTOCK



For rotary table	T002/160
MT	-
Center height	85 - 135 mm
Weight	9 kg

C051

€ 243,00

ADJUSTABLE TAILSTOCK



For rotary table	T001/250 - T002/200 - T002/250
MT	2
Center height	140 - 180 mm
Weight	18 kg

C052

€ 314,00

ADJUSTABLE TAILSTOCK



For rotary table	T002/320 - T001/320
MT	2
Center height	180 - 224 mm
Weight	21 kg

COMPATIBILITY CHART

Art.	€	D003	D023	T001/250	T001/320	T012/500	T012/630	T002/100	T002/160	T002/200	T002/250	T002/320	T002/400	D004/100L	D004/125L	D004/160L	D006/100	D006/128	PAG
D005	181,00			•	•				•	•	•	•							148
D005/100	55,30							•											148
D005/400	203,00												•						148
D005/500	269,00					•	•												148
C054	184,00		•						•										149
C051	243,00	•		•						•	•								149
C052	314,00				•							•							149
M049/125	169,00													•			•		158
M049/160	223,00		•												•			•	158
M449/125	195,00													•			•		158
M449/160	246,00		•												•			•	158
M049/200	308,00															•			158
M449/200	348,00															•			158
C053/2	16,00																•		155
C053/3	17,70			•										•				•	155
C053/4	26,10				•										•	•			155

D004-

UNIVERSAL DIVIDING HEAD WITH TAILSTOCK, CHUCK AND DIVIDING PLATES

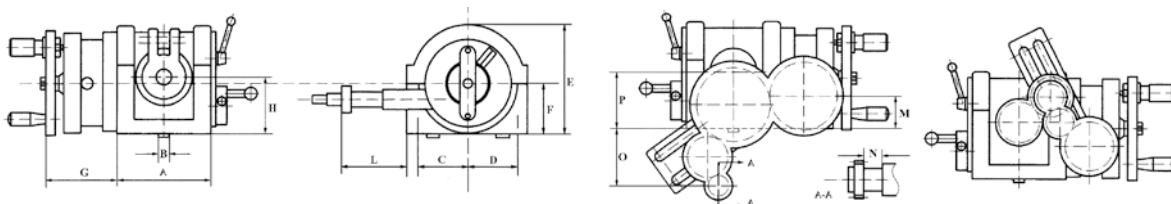

Art.	€	A	B	C	D	E	F	G	H	L	MT	N	P	Q	Chuck sizes	Ratio	Capacity	Weight	Plates holes
D004/100L	€ 1960,00	162	14	102	87	186	95	116	100	93	3	30	100	100	Ø 125 mm	1:40	100 kg	67 / 79 kg	24-25-28-30-34-37-38-39-41-42-43-46-47-49-51-53-54-57-58-59-62-66
D004/125L	€ 2190,00	209	18	116	98	224	117	120	125	103	4	34,5	100	125	Ø 160 mm	1:40	130 kg	119 / 132 kg	24-25-28-30-34-37-38-39-41-42-43-46-47-49-51-53-54-57-58-59-62-66
D004/160L	€ 2450,00	209	18	116	98	259	152	120	160	103	4	34,5	100	160	Ø 200 mm	1:40	130 kg	125 / 140 kg	24-25-28-30-34-37-38-39-41-42-43-46-47-49-51-53-54-57-58-59-62-66

D006-

SEMI UNIVERSAL DIVIDING HEAD WITH TAILSTOCK AND DIVIDING PLATES

CHUCK NOT INCLUDED

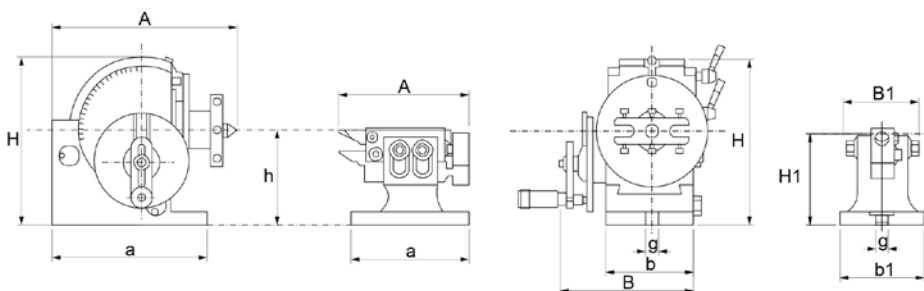

Art.	€	A	B	H	h	a	b	G	A1	B1	H1	h1	a1	b1	g1	Suitable chuck	Hole	MT	Ratio	Plates holes	Weight
D006/100	€ 676,00	193 mm	131 mm	173 mm	100 mm	166 mm	90 mm	16 mm	175 mm	87 mm	102 mm	100 mm	130 mm	82 mm	16 mm	Ø 125 mm	Ø 18 mm	2	1:40	15-16-17-18-19-20-21-23-27-29-31-33-37-39-41-43-47-49	21 kg
D006/128	€ 1100,00	242 mm	168 mm	220 mm	128 mm	206 mm	113 mm	16 mm	183 mm	87 mm	137 mm	128 mm	158 mm	110 mm	16 mm	Ø 160 mm	Ø 20 mm	3	1:40	15-16-17-18-19-20-21-23-27-29-31-33-37-39-41-43-47-49	30 kg

T013

€ 970,00

CROSS WORKING TABLE

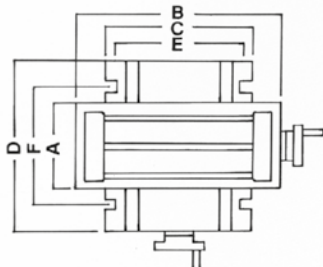

A	210 mm
B	730 mm
C	315 mm
D	395 mm
E	240 mm
F	300 mm
Slot	14 mm
Height	155 mm
Travels	160 x 360 mm
Signs	0,05 mm
Packing dimensions	960 x 510 x 280 mm
Weight	75 kg

T014G

€ 825,00

CROSS WORKING TABLE

SWIVEL

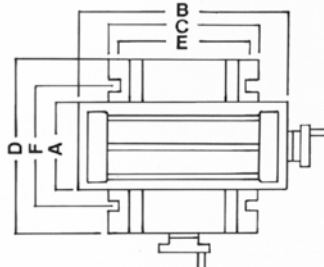

A	240 mm
B	600 mm
C	280 mm
D	340 mm
E	260 mm
F	250 mm
Slot	12 mm
Height	160 mm
Travels	155 x 370 mm
Signs	0,02 mm
Packing dimensions	770 x 440 x 230 mm
Weight	60 kg

T015

€ 437,00

CROSS WORKING TABLE

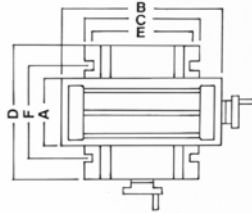
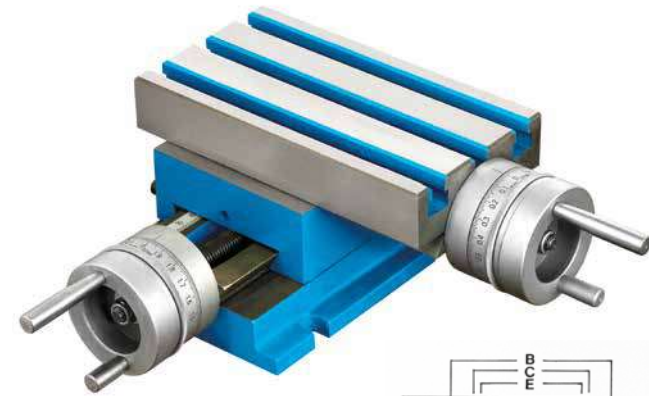

A	100 mm
B	185 mm
C	130 mm
D	170 mm
E	104 mm
F	103 mm
Slot	10 mm
Height	100 mm
Travels	50 x 80 mm
Signs	0,01 mm
Packing dimensions	290 x 240 x 140 mm
Weight	10 kg

T015/E

€ 232,00

CROSS WORKING TABLE

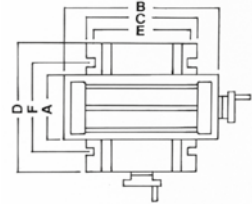
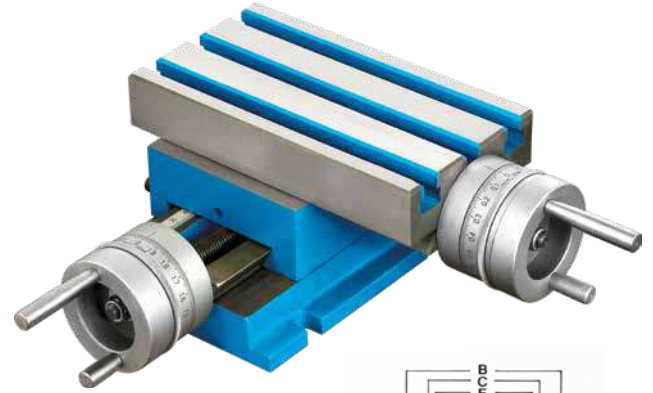

A	100 mm
b	185 mm
C	130 mm
D	173 mm
E	102 mm
F	100 mm
Slot	10 mm
Height	104 mm
Travels	50 x 80 mm
Signs	0,01 mm
Packing dimensions	290 x 280 x 180 mm
Weight	10 kg

T008

€ 270,00

CROSS WORKING TABLE

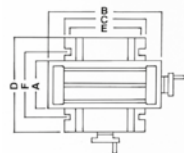

Table dimensions	475 x 153 x 130h mm
Travels	120 x 325 mm
Base dimensions	200 x 270 mm
Base locating slot	162 mm
Slot distance	75 mm
Slot	16 mm
Weight	23 kg

T018/350

CAT. 42 € 128,00

ALUMINIUM CROSS WORKING TABLE



A	350 mm
B	100 mm
C	190 mm
D	160 mm
Height	120 mm
Slot	14 mm
Travels	180 x 50 mm
Reading	0,05 mm
Weight	6,00 kg

T018/330

CAT. 42 € 68,30

ALUMINIUM CROSS WORKING TABLE

A	330 mm
B	95 mm
C	145 mm
D	125 mm
Height	82 mm
Slot	14 mm
Travels	190 x 65 mm
Signs	0,05 mm
Weight	2.50 kg

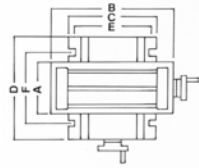

T004-

ADJUSTABLE ANGLE PLATE

WITH TILTING REGULATION ON BOTH SIDES

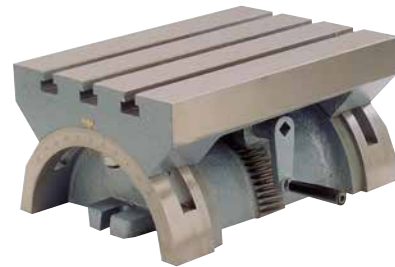

Art.	€	Dimensions	Slot	Tilting	Weight
T004/250	€ 318,00	255 x 180 x 135h mm	12 mm	± 36°	20 kg
T004/380	€ 483,00	380 x 250 x 180h mm	16 mm	± 36°	51 kg
T004/600	€ 823,00	610 x 305 x 253h mm	18 mm	± 36°	122 kg

P770-

MAGNETIC CHUCK

WITH FIXED POLARITY. IT ALLOWS THE MACHINING OF SMALL AND LOW THICKNESS PIECES DUE TO FINE PITCH



Art.	€	Dimensions	Max. magnetic force	Pole pitch	Weight
P770/1	€ 571,00	150 x 300 x 48h mm	120 N/cm2	0,5 + 1,5 mm	18 kg
P770/2	€ 657,00	150 x 350 x 48h mm	120 N/cm2	0,5 + 1,5 mm	21 kg
P770/3	€ 1310,00	200 x 500 x 53h mm	120 N/cm2	0,5 + 1,5 mm	44 kg

P07x

PERMANENT MAGNETIC CHUCKS



Art.	€	Dimensions	Max. magnetic force	Pole pitch	Weight
P070	€ 500,00	260 x 125 x 75h mm	120 N/cm2	16 / 12+4 mm	16 kg
P071	€ 676,00	300 x 150 x 75h mm	120 N/cm2	16 / 12+4 mm	21 kg
P072	€ 803,00	350 x 150 x 75h mm	120 N/cm2	16 / 12+4 mm	26 kg
P073	€ 1240,00	500 x 200 x 80h mm	120 N/cm2	16 / 12+4 mm	48 kg

**K001-
CLAMPING KIT**



58 Pz

Art.	€	Slot	MA	Set pc
K001/12	€ 92,70	12 mm	10	58
K001/14	€ 103,00	14 mm	12	58
K001/16	€ 120,00	16 mm	14	58
K001/18	€ 150,00	18 mm	16	58

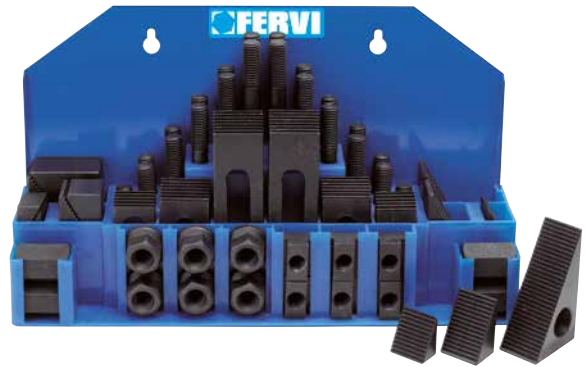

**K002-
CLAMPING SET**

STEP BLOCK IN POWDER METALLURGY WITH ZN COATING AND CLAMPS STRAPS IN #45 STEEL WITH ZN COATING

6 Pz

Art.	€	2 Step blocks	2 Clamp	2 Studs with Tee nuts	Slot	Weight
K002/08	€ 24,90	25 x 25 x 42 mm	100 x 25 x 15 mm	M6 x 100 mm	8 mm	1 kg
K002/10	€ 26,60	25 x 25 x 42 mm	100 x 25 x 15 mm	M8 x 100 mm	10 mm	1 kg
K002/12	€ 29,20	25 x 25 x 42 mm	100 x 25 x 15 mm	M10 x 100 mm	12 mm	1 kg
K002/14	€ 34,30	25 x 25 x 42 mm	100 x 31 x 19 mm	M12 x 100 mm	14 mm	1.15 kg



C046-

ROTARY LIVE CENTER

Art.	€	MT	Center	Body	Length
C046/2	€ 61,00	2	60°	Ø 45 mm	155 mm
C046/3	€ 74,00	3	60°	Ø 53 mm	175 mm
C046/4	€ 78,40	4	60°	Ø 63 mm	208 mm
C046/5	€ 108,00	5	60°	Ø 87 mm	256 mm



C050-

PRECISION LIVE CENTER SET

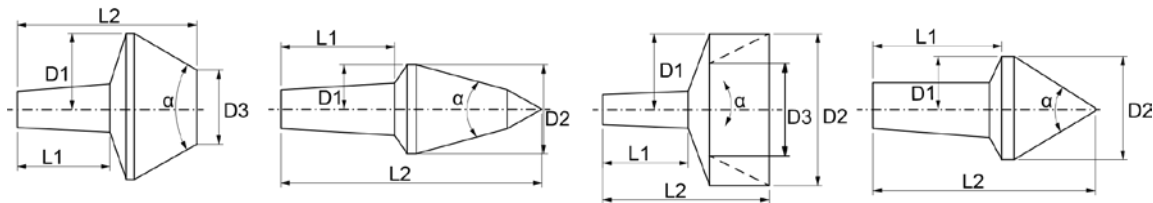

Art.	€	A	B	C	D	E	F	G	MT
C050/2	€ 147,00	L2 39 mm - D2-D3 16 mm - α 60°	L2 35,5 mm - D2-D3 16 mm - α 75°	L2 33 mm - D2-D3 16 mm - α 90°	L2 46 mm - D2-D3 16 mm - α 60°	L2 40 mm - D2-D3 25 mm / 10 mm - α 60°	L2 36 mm - D2-D3 16 mm / 10 mm - α 60°	L2 39 mm - D2-D3 20 mm / 16 mm - α 60°	2
C050/3	€ 165,00	L2 48 mm - D2-D3 20 mm - α 60°	L2 43,5 mm - D2-D3 20 mm - α 75°	L2 40,5 mm - D2-D3 20 mm - α 90°	L2 56 mm - D2-D3 18 mm - α 60°	L2 50 mm - D2-D3 35 mm / 15 mm - α 60°	L2 42 mm - D2-D3 22 mm / 18 mm - α 60°	L2 48 mm - D2-D3 35 mm / 30 mm - α 60°	3
C050/4	€ 240,00	L2 61,5 mm - D2-D3 28 mm - α 60°	L2 55,5 mm - D2-D3 28 mm - α 75°	L2 51,5 mm - D2-D3 28 mm - α 90°	L2 73 mm - D2-D3 26 mm - α 60°	L2 61,5 mm - D2-D3 55 mm / 30 mm - α 60°	L2 55 mm - D2-D3 40 mm / 35 mm - α 60°	L2 60 mm - D2-D3 55 mm / 48 mm - α 60°	4

C055-

TUBE ROTARY LIVE CENTER

Art.	€	MT	Ø	Length	Speeds
C055/3	€ 176,00	3	30 ÷ 100 mm	170 mm	max 2500 rpm
C055/4	€ 249,00	4	40 ÷ 160 mm	230 mm	max 1600 rpm
C055/5	€ 349,00	5	66 ÷ 200 mm	260 mm	max 1500 rpm



C053-

CARBIDE TIPPED DEAD CENTER

Art.	€	MT	Carbide center max	Length
C053/2	€ 16,00	2 - 60°	Ø 8 mm	100 mm
C053/3	€ 17,70	3 - 60°	Ø 11 mm	125 mm
C053/4	€ 26,10	4 - 60°	Ø 13 mm	160 mm
C053/5	€ 40,50	5 - 60°	Ø 17 mm	200 mm



ST45-

PRECISION MORSE TAPER REDUCTION SLEEVE



Art.	€	MT
ST45/2/1	€ 9,50	2/1
ST45/3/1	€ 11,60	3/1
ST45/3/2	€ 12,40	3/2
ST45/4/1	€ 16,00	4/1
ST45/4/2	€ 16,00	4/2
ST45/4/3	€ 16,00	4/3
ST45/5/3	€ 25,50	5/3
ST45/5/4	€ 25,50	5/4

A001-

PRECISION DRILL CHUCK SHANK



Art.	€	MT	B
A001/2/12	€ 7,60	2	12 mm
A001/2/16	€ 8,60	2	16 mm
A001/2/18	€ 8,90	2	18 mm
A001/3/12	€ 13,30	3	12 mm
A001/3/16	€ 13,30	3	16 mm
A001/3/18	€ 13,30	3	18 mm
A001/3/22	€ 13,30	3	22 mm
A001/4/16	€ 16,00	4	16 mm
A001/4/18	€ 16,00	4	18 mm
A001/4/22	€ 16,00	4	22 mm

E002-

DRIFT SLEEVES



Art.	€	MT
E002/12	€ 6,60	1-2
E002/3	€ 6,60	3
E002/4	€ 9,50	4

ST45-xL

CAT. 42

EXTENDED MORSE TAPER ADAPTERS



Art.	€	MT	L	l	D	Weight
ST45/2/1L	€ 15,00	2/1	160 mm	85 mm	20 mm	0.00 kg
ST45/2/2L	€ 18,30	2/2	175 mm	100 mm	30 mm	0.00 kg
ST45/2/3L	€ 20,80	2/3	196 mm	121 mm	36 mm	0.00 kg
ST45/3/1L	€ 19,60	3/1	175 mm	81 mm	20 mm	0.00 kg
ST45/3/2L	€ 20,80	3/2	194 mm	100 mm	30 mm	0.00 kg
ST45/3/3L	€ 29,20	3/3	215 mm	121 mm	36 mm	0.00 kg
ST45/3/4L	€ 37,50	3/4	240 mm	146 mm	48 mm	0.00 kg
ST45/4/1L	€ 30,40	4/1	200 mm	82,5 mm	20 mm	0.00 kg
ST45/4/2L	€ 31,30	4/2	215 mm	97,5 mm	30 mm	0.00 kg
ST45/4/3L	€ 37,90	4/3	240 mm	122,5 mm	36 mm	0.00 kg
ST45/4/4L	€ 42,10	4/4	265 mm	147,5 mm	48 mm	0.00 kg
ST45/4/5L	€ 60,40	4/5	300 mm	182,5 mm	63 mm	0.00 kg
ST45/5/1L	€ 49,20	5/1	232 mm	82,5 mm	20 mm	0.00 kg
ST45/5/2L	€ 50,00	5/2	247 mm	97,5 mm	30 mm	0.00 kg
ST45/5/3L	€ 50,00	5/3	268 mm	118,5 mm	36 mm	0.00 kg
ST45/5/4L	€ 56,70	5/4	300 mm	150,5 mm	48 mm	0.00 kg
ST45/5/5L	€ 82,90	5/5	335 mm	185,5 mm	63 mm	0.00 kg
ST45/5/6L	€ 142,00	5/6	396 mm	247 mm	82 mm	0.00 kg

M050-

KEYLESS CHUCK



Art.	€	Capacity	Shank
M050/10	€ 10,70	1 ÷ 10 mm	3/8 24 UNF
M050/13	€ 13,10	2 ÷ 13 mm	1/2 20 UNF

M080/10

€ 14,80

KEYLESS CHUCK WITH LOCK



Capacity	0,8 ÷ 10 mm
Shank	3/8 24 UNF

M080/13

€ 16,00

KEYLESS CHUCK WITH LOCK



Capacity	2 ÷ 13 mm
Shank	1/2 20 UNF

M051-

HIGH PRECISION 3 JAWS KEYLESS DRILL CHUCK



Art.	€	Capacity	Taper DIN	Dimension	Dimension
M051/08	€ 46,70	0,5 ÷ 8 mm	B 12	Ø 39 mm	80h mm
M051/10	€ 46,70	1 ÷ 10 mm	B 12	Ø 44,5 mm	82h mm
M051/13	€ 54,80	1 ÷ 13 mm	B 16	Ø 49,5 mm	91h mm
M051/16	€ 66,10	1 ÷ 16 mm	B 18	Ø 54 mm	102,5h mm
M051/20	€ 85,00	1 ÷ 20 mm	B 22	Ø 59 mm	119h mm

FD0x-

MOUNTING WITH STUD

WITH ROUGHLY MACHINE CHUCK SIDE

Art.	€	Cam lock Type	Size	Thickness	Pins
FD04/200	€ 165,00	4"	Ø 200 mm	28 mm	Ø 15,9 mm
FD05/200	€ 165,00	5"	Ø 200 mm	30 mm	Ø 19 mm
FD05/250	€ 227,00	5"	Ø 250 mm	30 mm	Ø 19 mm
FD06/250	€ 232,00	6"	Ø 250 mm	30 mm	Ø 22 mm
FD06/380	€ 308,00	6"	Ø 400 mm	30 mm	Ø 22 mm
FD08/250	€ 234,00	8"	Ø 250 mm	30 mm	Ø 25,4 mm
FD08/320	€ 269,00	8"	Ø 320 mm	30 mm	Ø 25,4 mm
FD08/380	€ 409,00	8"	Ø 400 mm	30 mm	Ø 25,4 mm
FD08/500	€ 471,00	8"	Ø 500 mm	36 mm	Ø 25,4 mm
FD11/320	€ 285,00	11"	Ø 320 mm	30 mm	Ø 30,0 mm
FD11/400	€ 392,00	11"	Ø 400 mm	30 mm	Ø 30,0 mm
FD11/500	€ 501,00	11"	Ø 500 mm	36 mm	Ø 30 mm

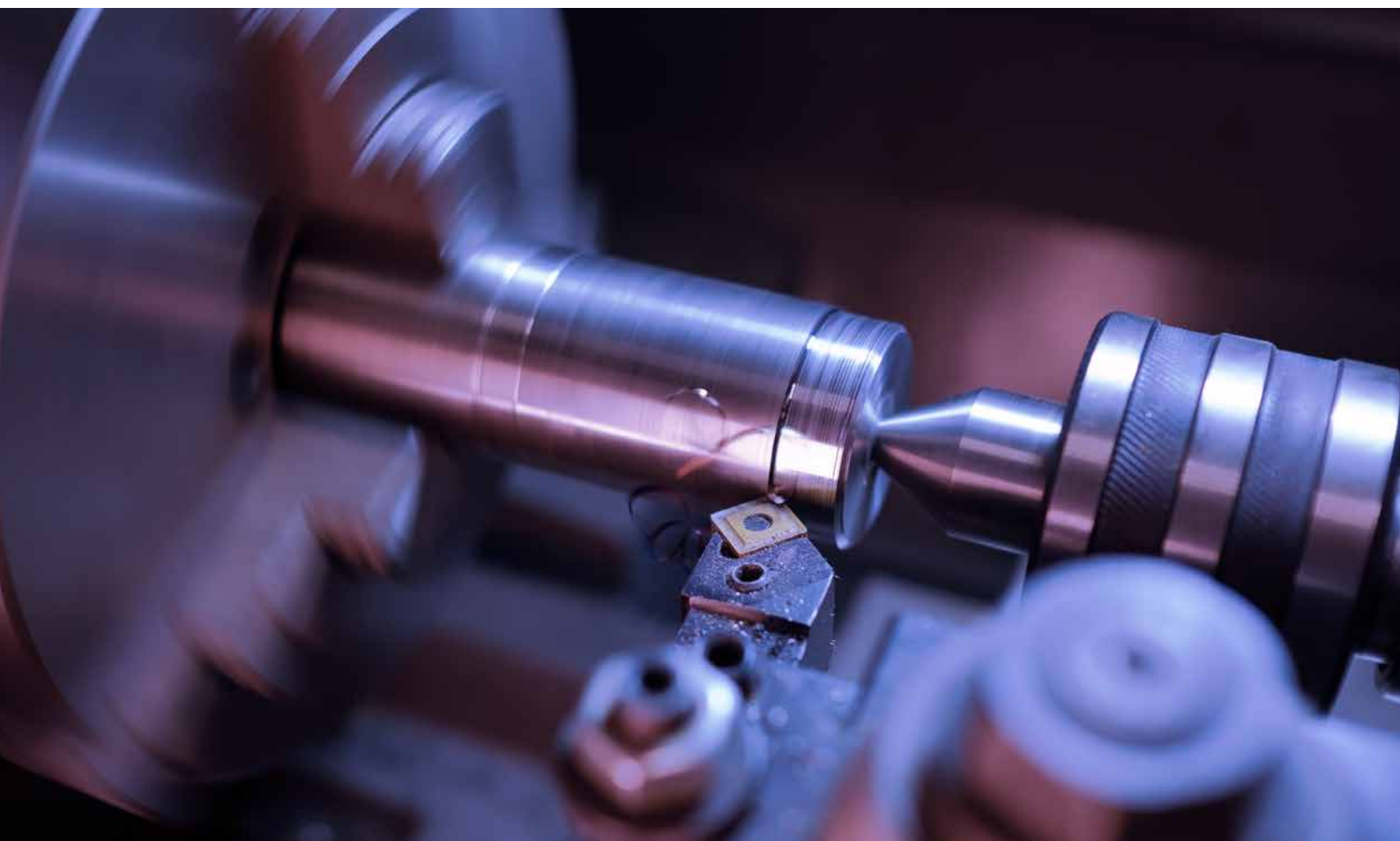

M049-

PRECISION SELF CENTERING

3+3 JAWS CHUCK

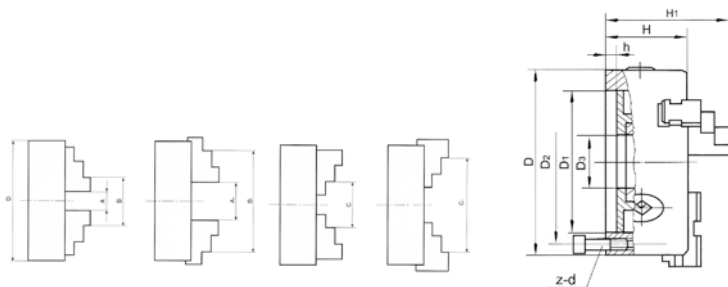

Art.	D	D1	D2	D3	H1	H	h	z-d	Spanner square
M049/080	80 mm	55 mm	66 mm	16 mm	66 mm	50 mm	3,5 mm	3-M6 mm	8 mm
M049/100	100 mm	72 mm	84 mm	22 mm	74,5 mm	55 mm	3,5 mm	3-M8 mm	8 mm
M049/125	125 mm	95 mm	108 mm	30 mm	78 mm	55 mm	3,5 mm	3-M8 mm	10 mm
M049/160	160 mm	130 mm	142 mm	40 mm	95 mm	65 mm	5 mm	3-M8 mm	12 mm
M049/200	200 mm	165 mm	180 mm	60 mm	109 mm	75 mm	5 mm	3-M10 mm	12 mm
M049/250	250 mm	206 mm	226 mm	80 mm	120 mm	80 mm	5 mm	3-M12 mm	12 mm
M049/320	320 mm	270 mm	290 mm	100 mm	152,5 mm	95 mm	11 mm	3-M16 mm	13 mm
M049/400	400 mm	340 mm	368 mm	130 mm	158 mm	100 mm	6 mm	3-M16 mm	17 mm

Art.	€	D	A - A1	B - B1	C - C1	Weight
M049/080	€ 143,00	80 mm	2 - 22 mm	25 - 70 mm	22 - 63 mm	2 kg
M049/100	€ 160,00	100 mm	2 - 30 mm	30 - 90 mm	30 - 80 mm	3,3 kg
M049/125	€ 169,00	125 mm	2,5 - 40 mm	38 - 125 mm	38 - 110 mm	4,8 kg
M049/160	€ 223,00	160 mm	3 - 55 mm	50 - 160 mm	55 - 145 mm	9,1 kg
M049/200	€ 308,00	200 mm	4 - 85 mm	65 - 200 mm	65 - 200 mm	15,7 kg
M049/250	€ 359,00	250 mm	6 - 110 mm	80 - 250 mm	90 - 250 mm	30 kg
M049/320	€ 635,00	320 mm	10 - 140 mm	95 - 320 mm	100 - 320 mm	47,5 kg
M049/400	€ 987,00	400 mm	15 - 210 mm	120 - 400 mm	120 - 400 mm	74 kg

M449-

PRECISION SELF CENTERING

4+4 JAWS CHUCK

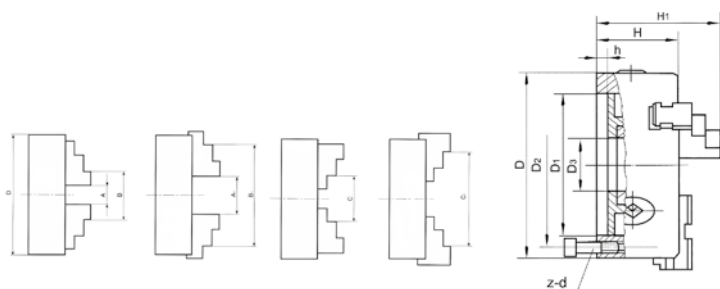

Art.	D	D1	D2	D3	H1	H	h	z-d	Spanner square
M449/080	80 mm	55 mm	66 mm	16 mm	66 mm	50 mm	3,5 mm	3 - M6 mm	8 mm
M449/100	100 mm	72 mm	84 mm	22 mm	74,5 mm	55 mm	3,5 mm	3 - M8 mm	8 mm
M449/125	125 mm	95 mm	108 mm	30 mm	84 mm	58 mm	4 mm	3 - M8 mm	10 mm
M449/160	160 mm	130 mm	142 mm	40 mm	95 mm	65 mm	5 mm	3 - M8 mm	10 mm
M449/200	200 mm	165 mm	187 mm	65 mm	109 mm	75 mm	5 mm	3 - M10 mm	12 mm
M449/250	250 mm	206 mm	226 mm	80 mm	120 mm	80 mm	5 mm	3 - M12 mm	12 mm
M449/320	320 mm	270 mm	290 mm	100 mm	152,5 mm	95 mm	11 mm	3-M16 mm	13 mm
M449/400	400 mm	340 mm	368 mm	130 mm	158 mm	100 mm	6 mm	3-M16 mm	17 mm

Art.	€	D	A - A1	B - B1	C - C1	Weight
M449/080	€ 150,00	80 mm	2 - 22 mm	25 - 70 mm	22 - 63 mm	2 kg
M449/100	€ 169,00	100 mm	2 - 30 mm	30 - 90 mm	30 - 80 mm	3,5 kg
M449/125	€ 195,00	125 mm	2,5 - 40 mm	38 - 125 mm	38 - 110 mm	5,5 kg
M449/160	€ 246,00	160 mm	3 - 55 mm	50 - 160 mm	55 - 145 mm	9,4 kg
M449/200	€ 348,00	200 mm	4 - 85 mm	65 - 200 mm	65 - 200 mm	17,5 kg
M449/250	€ 450,00	250 mm	6 - 110 mm	80 - 250 mm	90 - 250 mm	28,9 kg
M449/320	€ 773,00	320 mm	10 - 140 mm	95 - 320 mm	100 - 320 mm	47,5 kg
M449/400	€ 1200,00	400 mm	15 - 210 mm	120 - 400 mm	120 - 400 mm	74 kg

M005-

PRECISION SELF CENTERING CHUCK

3 JAWS WITH REVERSIBLE TOP JAWS

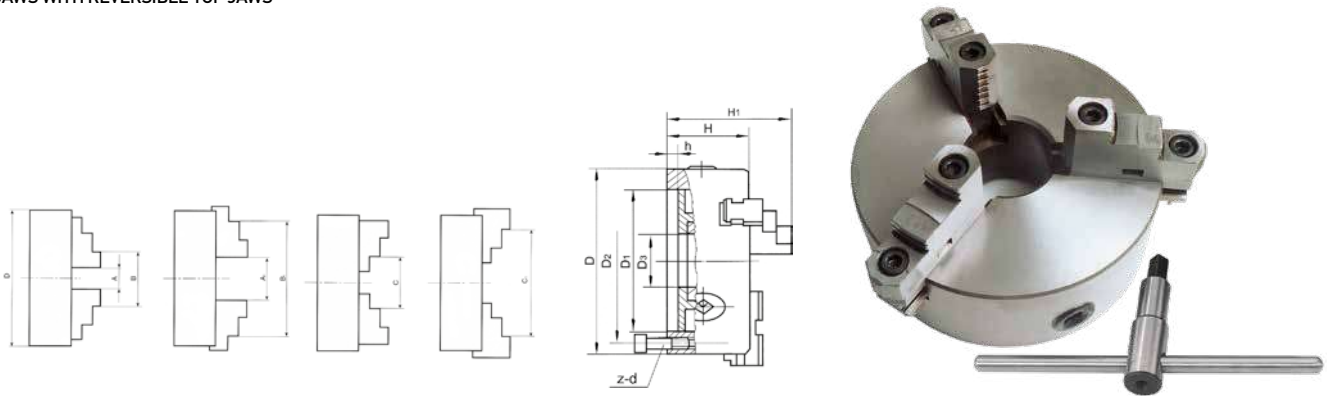

Art.	D	D1	D2	D3	H1	H	h	z-d	Spanner square
M005/200	200 mm	165 mm	180 mm	65 mm	122 mm	75 mm	5 mm	3-M10 mm	12 mm
M005/250	250 mm	206 mm	226 mm	80 mm	135 mm	80 mm	5 mm	3-M12 mm	12 mm
M005/320	320 mm	270 mm	290 mm	100 mm	135 mm	90 mm	6 mm	3-M16 mm	14 mm
M005/400	400 mm	340 mm	368 mm	130 mm	172 mm	100 mm	6 mm	3-M16 mm	17 mm
M005/500	500 mm	440 mm	465 mm	200 mm	202 mm	115 mm	6 mm	6-M16 mm	17 mm
M005/630	630 mm	560 mm	595 mm	260 mm	218 mm	130 mm	7 mm	6-M16 mm	19 mm

Art.	€	D	A - A1	B - B1	C - C1	Weight
M005/200	€ 308,00	200 mm	4 - 85 mm	65 - 200 mm	65 - 200 mm	18 kg
M005/250	€ 359,00	250 mm	6 - 110 mm	80 - 250 mm	90 - 250 mm	29 kg
M005/320	€ 566,00	320 mm	10 - 140 mm	95 - 315 mm	100 - 315 mm	55 kg
M005/400	€ 911,00	400 mm	15 - 210 mm	120 - 400 mm	120 - 400 mm	80 kg
M005/500	€ 1550,00	500 mm	25 - 280 mm	150 - 500 mm	150 - 500 mm	132 kg
M005/630	€ 4380,00	630 mm	50 - 350 mm	170 - 630 mm	170 - 630 mm	200 kg

P444-

CAT. 42

4 JAW INDEPENDENT CHUCK

WITH CHUCK KEY



Art.	€	D	D1	D2	D3	H1	H	h	z-d	Spanner square	Weight
P444/160	€ 193,00	160 mm	65 mm	95 mm	45 mm	67 mm	97 mm	4 mm	4 - M10 mm	10 mm	8.8 kg
P444/200	€ 252,00	200 mm	75 mm	95 mm	56 mm	75 mm	107 mm	6 mm	4 - M10 mm	10 mm	13.2 kg
P444/250	€ 336,00	250 mm	110 mm	130 mm	100 mm	80 mm	120 mm	6 mm	4 - M12 mm	12 mm	21.4 kg
P444/320	€ 539,00	320 mm	140 mm	165 mm	95 mm	90 mm	134 mm	6 mm	4 - M16 mm	14 mm	43 kg
P444/400	€ 706,00	400 mm	160 mm	185 mm	125 mm	95 mm	141 mm	8 mm	4 - M16 mm	14 mm	63 kg

M049-xST

3 SOLID SOFT JAWS SET



Art.	€	Diameter
M049/125ST	€ 77,30	Ø 125 mm
M049/160ST	€ 85,80	Ø 160 mm

M449-xST

4 SOLID SOFT JAWS SET



Art.	€	Diameter
M449/125ST	€ 95,00	Ø 125 mm
M449/160ST	€ 111,00	Ø 160 mm

M049-xGBD

3 SOFT JAWS SET



Art.	€	Diameter
M049/200GBD	€ 150,00	Ø 200 mm
M049/250GBD	€ 198,00	Ø 250 mm
M049/320GBD	€ 277,00	Ø 320 mm
M049/400GBD	€ 356,00	Ø 400 mm

M449-xGBD

4 SOFT JAWS SET



Art.	€	Diameter
M449/200GBD	€ 223,00	Ø 200 mm
M449/250GBD	€ 296,00	Ø 250 mm
M449/320GBD	€ 438,00	Ø 320 mm
M449/400GBD	€ 558,00	Ø 400 mm

2622x

SOFT TOP JAW FOR CHUCKS

Art.	€	Ø	Slot distance
M075/160T	€ 21,00	160 mm	38,1 mm
M075/200T	€ 23,20	200 mm	44,50 mm
M075/250T	€ 25,00	250 mm	54 mm
M075/315T	€ 31,30	315 mm	63,5 mm
262206R	€ 63,70	400 mm	76,2 mm
262207R	€ 88,40	500 - 630 mm	76,2 mm

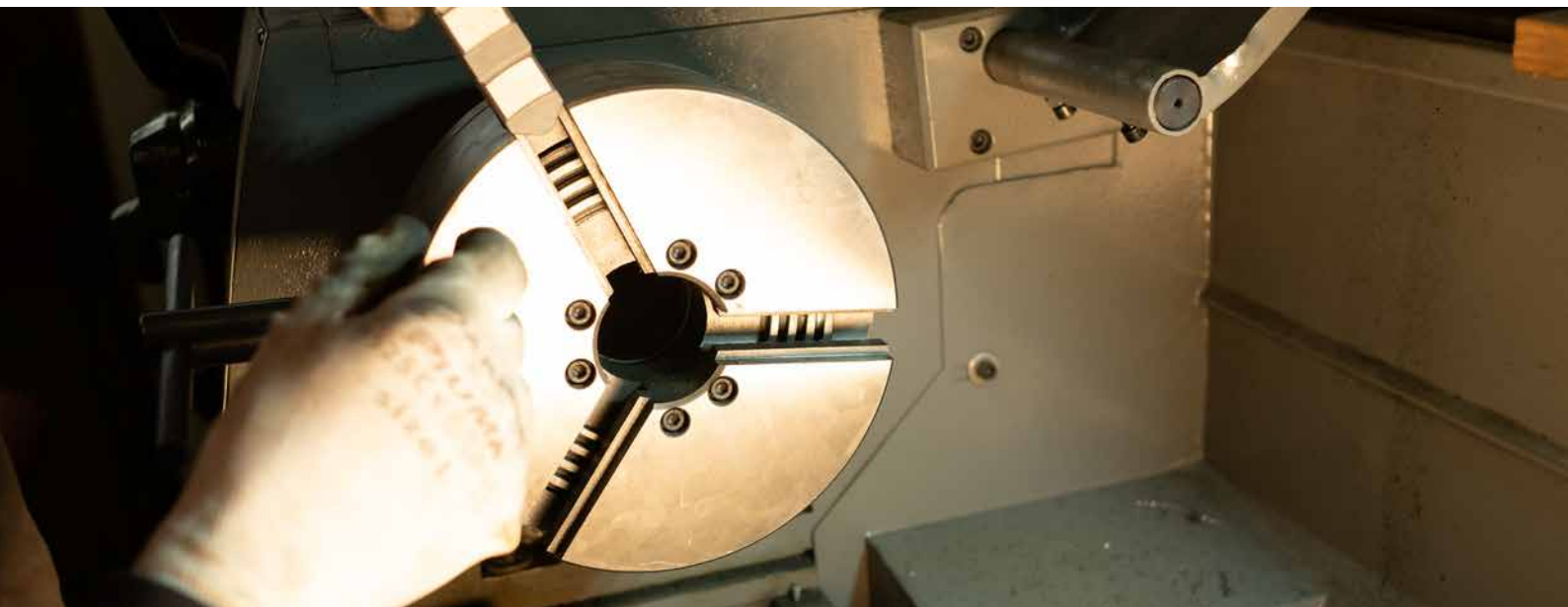

M059-

REVERSIBLE TAPPING CHUCK WITH ADJUSTABLE CLUTCH



Art.	€	Tapping range	Dimensions w/o MT	MT	Shank	Weight
M059/07	€ 405,00	M 2 - 7	Ø 55 x 130h mm	2	B16	2 kg
M059/12	€ 464,00	M 5 - 12	Ø 75 x 162h mm	3	B16	2,75 kg
M059/20	€ 568,00	M 8 - 20	Ø 91 x 204h mm	4	B22	5 kg

M060-

TAPPING CHUCK

WITH ADJUSTABLE CLUTCH HOLDERS AND AXIAL COMPENSATION, 6 HOLDERS SHANK FOR TAPPING WITH Ø 19 mm, HOLE HOLDERS FOR SQUARE 3,5 X 2,7 mm - 4,5 X 3,4 mm - 6 X 4,9 mm - 8 X 6,2 mm - 10 X 8 mm - 9 X 7 mm



Art.	€	Tapping range	Arbor length with and without holder	MT	Weight
M060/2	€ 374,00	M 3 - 12	213 - 175 - Ø 46 mm	2	3 kg
M060/3	€ 374,00	M 3 - 12	228 - 190 - Ø 46 mm	3	3,2 kg
M060/4	€ 400,00	M 3 - 12	253 - 215 - Ø 46 mm	4	3,6 kg

M004-

HOLE CUTTER SHANK WITH COOLANT SYSTEM AND WELDON SHANK

MT2 HOLE



Art.	€	Spindle taper MT	Total length	Female junction	Weight
M004/2	€ 149,00	2	170,5 mm	Weldom 19,05 mm	0,76 kg
M004/3	€ 149,00	3	190,5 mm	Weldom 19,05 mm	0,95 kg

16Ax

ARBOR FOR MILLING CUTTERS

BALANCED CHUCK BODY

DIN 69871/A

Art.	€	ISO	d-h6	L	L1	Balancing rpm
16A40	€ 91,00	40	16 mm	27 mm	35 mm	12000
22A40	€ 91,00	40	22 mm	31 mm	41 mm	12000
27A40	€ 91,00	40	27 mm	33 mm	41 mm	12000
32A40	€ 101,00	40	32 mm	38 mm	45 mm	12000
16A50	€ 126,00	50	16 mm	27 mm	35 mm	12000
22A50	€ 126,00	50	22 mm	31 mm	35 mm	12000
27A50	€ 126,00	50	27 mm	33 mm	35 mm	12000
32A50	€ 135,00	50	32 mm	38 mm	40 mm	12000
40A50	€ 147,00	50	40 mm	41 mm	40 mm	12000

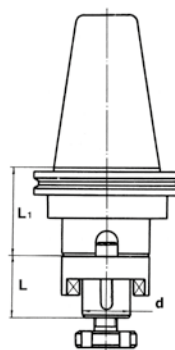

4-

WELDON SHANK TOOL HOLDER

BALANCED CHUCK BODY

DIN 69871/A

Art.	€	ISO	d1 - h6	D	L	Balancing rpm
4/06A40	€ 74,00	40	6 mm	25 mm	60 mm	12000
4/08A40	€ 74,00	40	8 mm	28 mm	60 mm	12000
4/10A40	€ 74,00	40	10 mm	35 mm	50 mm	12000
4/12A40	€ 74,00	40	12 mm	42 mm	60 mm	12000
4/14A40	€ 74,00	40	14 mm	42 mm	70 mm	12000
4/16A40	€ 74,00	40	16 mm	48 mm	70 mm	12000
4/18A40	€ 74,00	40	18 mm	48 mm	70 mm	12000
4/20A40	€ 74,00	40	20 mm	52 mm	63 mm	12000
4/25A40	€ 74,00	40	25 mm	40 mm	100 mm	12000
4/32A40	€ 74,00	40	32 mm	72 mm	100 mm	12000
4/06A50	€ 102,00	50	6 mm	25 mm	65 mm	12000
4/08A50	€ 102,00	50	8 mm	28 mm	65 mm	12000

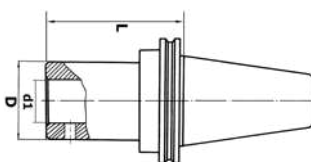

Art.	€	ISO	d1 - h6	D	L	Balancing rpm
4/10A50	€ 102,00	50	10 mm	35 mm	70 mm	12000
4/12A50	€ 102,00	50	12 mm	42 mm	75 mm	12000
4/14A50	€ 102,00	50	14 mm	42 mm	75 mm	12000
4/16A50	€ 102,00	50	16 mm	48 mm	80 mm	12000
4/18A50	€ 102,00	50	18 mm	48 mm	80 mm	12000
4/20A50	€ 102,00	50	20 mm	52 mm	80 mm	12000
4/25A50	€ 108,00	50	25 mm	65 mm	100 mm	12000
4/32A50	€ 108,00	50	32 mm	72 mm	105 mm	12000
4/40A50	€ 117,00	50	40 mm	80 mm	120 mm	12000



1-xA

MORSE TAPER ADAPTER

BALANCED CHUCK BODY

DIN 69871/A

Art.	€	ISO	MT	D	L	Balancing rpm
1/1A40	€ 80,30	40	1	25 mm	45 mm	12000
1/2A40	€ 80,30	40	2	32 mm	60 mm	12000
1/3A40	€ 80,30	40	3	40 mm	75 mm	12000
1/4A40	€ 80,30	40	4	50 mm	98 mm	12000
1/2A50	€ 118,00	50	2	32 mm	40 mm	12000
1/3A50	€ 118,00	50	3	40 mm	50 mm	12000
1/4A50	€ 127,00	50	4	48 mm	95 mm	12000
1/5A50	€ 155,00	50	5	63 mm	110 mm	12000

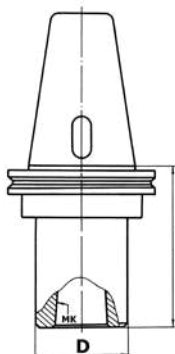

2-xA

MORSE TAPER ADAPTER WITH THREAD

BALANCED CHUCK BODY

DIN 69871/A

Art.	€	ISO	MT	D	L	Balancing rpm
2/1A40	€ 102,00	40	1	25 mm	45 mm	12000
2/2A40	€ 102,00	40	2	32 mm	60 mm	12000
2/3A40	€ 102,00	40	3	40 mm	75 mm	12000
2/4A40	€ 102,00	40	4	50 mm	98 mm	12000
2/2A50	€ 126,00	50	2	32 mm	40 mm	12000
2/3A50	€ 126,00	50	3	40 mm	50 mm	12000
2/4A50	€ 143,00	50	4	50 mm	80 mm	12000
2/5A50	€ 169,00	50	5	63 mm	110 mm	12000

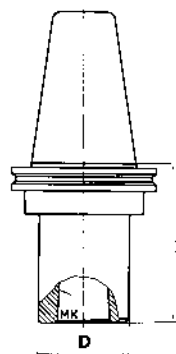

TIPAx

TIP

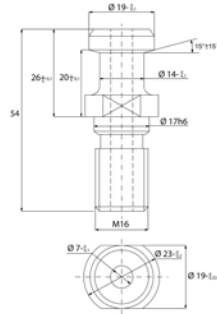

DIN 69871/A

Art.	€	ISO
TIPA40	€ 15,10	40
TIPA50	€ 16,00	50

4-xD

WELDON SHANK TOOL HOLDER

BALANCED CHUCK BODY

MAS - 403 BT

Art.	€	BT	d1 - h6	D	L	Balancing rpm
4/06D40	€ 80,30	40	6 mm	25 mm	60 mm	12000
4/08D40	€ 80,30	40	8 mm	28 mm	60 mm	12000
4/10D40	€ 80,30	40	10 mm	35 mm	60 mm	12000
4/12D40	€ 80,30	40	12 mm	42 mm	70 mm	12000
4/14D40	€ 80,30	40	14 mm	42 mm	70 mm	12000
4/16D40	€ 80,30	40	16 mm	48 mm	70 mm	12000
4/18D40	€ 80,30	40	18 mm	48 mm	70 mm	12000
4/20D40	€ 80,30	40	20 mm	52 mm	75 mm	12000
4/25D40	€ 80,30	40	25 mm	63 mm	100 mm	12000
4/32D40	€ 80,30	40	32 mm	72 mm	100 mm	12000
4/06D50	€ 106,00	50	6 mm	25 mm	65 mm	12000
4/08D50	€ 106,00	50	8 mm	28 mm	65 mm	12000
4/10D50	€ 106,00	50	10 mm	35 mm	70 mm	12000
4/12D50	€ 106,00	50	12 mm	42 mm	75 mm	12000
4/14D50	€ 106,00	50	14 mm	42 mm	75 mm	12000
4/16D50	€ 106,00	50	16 mm	48 mm	80 mm	12000
4/18D50	€ 106,00	50	18 mm	48 mm	80 mm	12000

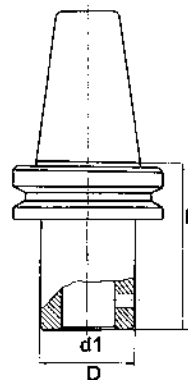

Art.	€	BT	d1 - h6	D	L	Balancing rpm
4/20D50	€ 106,00	50	20 mm	52 mm	80 mm	12000
4/25D50	€ 118,00	50	25 mm	65 mm	100 mm	12000
4/32D50	€ 118,00	50	32 mm	72 mm	105 mm	12000
4/40D50	€ 118,00	50	40 mm	80 mm	120 mm	12000

1-xD

MORSE TAPER ADAPTER

BALANCED CHUCK BODY

MAS - 403 BT

Art.	€	BT	MT	D	L	Balancing rpm
1/1D40	€ 80,30	40	1	25 mm	45 mm	12000
1/2D40	€ 80,30	40	2	32 mm	60 mm	12000
1/3D40	€ 80,30	40	3	40 mm	75 mm	12000
1/4D40	€ 80,70	40	4	50 mm	98 mm	12000
1/2D50	€ 118,00	50	2	32 mm	40 mm	12000
1/3D50	€ 118,00	50	3	40 mm	75 mm	12000
1/4D50	€ 131,00	50	4	50 mm	80 mm	12000
1/5D50	€ 155,00	50	5	63 mm	110 mm	12000

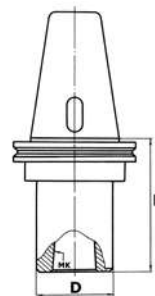

2-xD

MORSE TAPER ADAPTER WITH THREAD

BALANCED CHUCK BODY

MAS - 403 BT

Art.	€	BT	MT	D	L	Balancing rpm
2/1D40	€ 97,40	40	1	25 mm	45 mm	12000
2/2D40	€ 97,40	40	2	32 mm	60 mm	12000
2/3D40	€ 97,40	40	3	40 mm	75 mm	12000
2/4D40	€ 102,00	40	4	50 mm	98 mm	12000
2/2D50	€ 130,00	50	2	32 mm	40 mm	12000
2/3D50	€ 130,00	50	3	40 mm	75 mm	12000
2/4D50	€ 151,00	50	4	50 mm	80 mm	12000
2/5D50	€ 171,00	50	5	63 mm	110 mm	12000

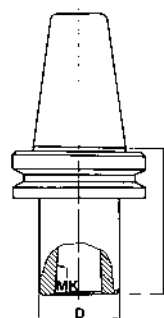

16-D

ARBOR FOR MILLING CUTTER

BALANCED CHUCK BODY

MAS - 403 BT

Art.	€	BT	d - h6	L	L1	Balancing rpm
16/D40	€ 91,00	40	16 mm	27 mm	35 mm	12000
22/D40	€ 91,00	40	22 mm	31 mm	35 mm	12000
27/D40	€ 91,00	40	27 mm	33 mm	35 mm	12000
32/D40	€ 101,00	40	32 mm	38 mm	40 mm	12000
16/D50	€ 127,00	50	16 mm	27 mm	35 mm	12000
22/D50	€ 127,00	50	22 mm	31 mm	35 mm	12000
27/D50	€ 136,00	50	27 mm	33 mm	35 mm	12000
32/D50	€ 136,00	50	32 mm	38 mm	40 mm	12000
40/D50	€ 145,00	50	40 mm	41 mm	40 mm	12000

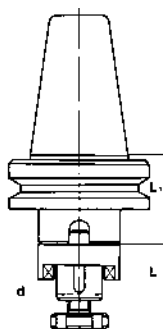

TIPDx

TIP

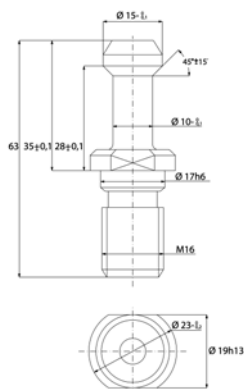

MAS - 403 BT

Art.	€	ISO
TIPD40	€ 15,10	40
TIPD50	€ 16,00	50

2-xB

MORSE TAPER ADAPTER WITH THREAD

BALANCED CHUCK BODY

DIN 2080

Art.	€	ISO	MT	D	L	Balancing rpm
2/1B40	€ 97,40	40	1	25 mm	50 mm	2000
2/2B40	€ 97,40	40	2	32 mm	30 mm	2000
2/3B40	€ 97,40	40	3	40 mm	64 mm	2000
2/4B40	€ 109,00	40	4	50 mm	94 mm	2000
2/2B50	€ 131,00	50	2	32 mm	60 mm	2000
2/3B50	€ 131,00	50	3	40 mm	30 mm	2000
2/4B50	€ 143,00	50	4	50 mm	65 mm	2000
2/5B50	€ 156,00	50	5	63 mm	105 mm	2000

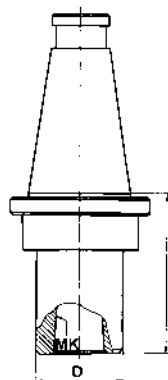

16-B

ARBOR FOR MILLING CUTTERS

BALANCED CHUCK BODY

DIN 2080

Art.	€	ISO	d - h6	L	L1	Balancing rpm
16/B40	€ 100,00	40	16 mm	27 mm	35 mm	2000
22/B40	€ 100,00	40	22 mm	31 mm	39 mm	2000
27/B40	€ 100,00	40	27 mm	33 mm	40 mm	2000
32/B40	€ 100,00	40	32 mm	38 mm	40 mm	2000
16/B50	€ 121,00	50	16 mm	27 mm	35 mm	2000
22/B50	€ 121,00	50	22 mm	31 mm	35 mm	2000
27/B50	€ 121,00	50	27 mm	33 mm	35 mm	2000
32/B50	€ 130,00	50	32 mm	38 mm	40 mm	2000
40/B50	€ 140,00	50	40 mm	41 mm	40 mm	2000

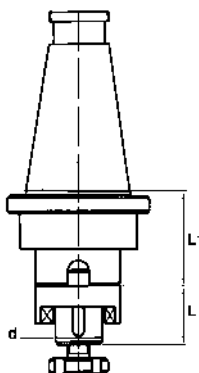

4-xB

WELDON SHANK TOOL HOLDER

BALANCED CHUCK BODY

MAS - 403 BT

Art.	€	ISO	d1 - h6	D	L	Balancing rpm
4/06B40	€ 80,30	40	6 mm	25 mm	50 mm	2000
4/08B40	€ 80,30	40	8 mm	28 mm	50 mm	2000
4/10B40	€ 80,30	40	10 mm	35 mm	50 mm	2000
4/12B40	€ 80,30	40	12 mm	42 mm	50 mm	2000
4/16B40	€ 80,30	40	16 mm	48 mm	63 mm	2000
4/18B40	€ 80,30	40	18 mm	48 mm	50 mm	2000
4/20B40	€ 80,30	40	20 mm	52 mm	63 mm	2000
4/25B40	€ 80,30	40	25 mm	65 mm	100 mm	2000
4/32B40	€ 80,30	40	32 mm	72 mm	80 mm	2000
4/06B50	€ 108,00	50	6 mm	25 mm	50 mm	2000
4/08B50	€ 108,00	50	8 mm	28 mm	50 mm	2000
4/10B50	€ 108,00	50	10 mm	35 mm	50 mm	2000
4/12B50	€ 108,00	50	12 mm	42 mm	50 mm	2000
4/16B50	€ 108,00	50	16 mm	48 mm	50 mm	2000

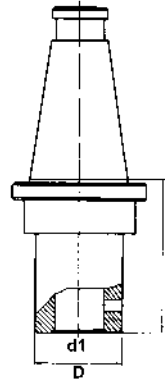

Art.	€	ISO	d1 - h6	D	L	Balancing rpm
4/20B50	€ 118,00	50	20 mm	52 mm	63 mm	2000
4/25B50	€ 118,00	50	25 mm	65 mm	80 mm	2000
4/32B50	€ 118,00	50	32 mm	72 mm	80 mm	2000
4/40B50	€ 127,00	50	40 mm	90 mm	90 mm	2000

S007-

0° ÷ 90° TILTING TOOL

TIGHTENING FIXTURE

DIN 2080, DIN 69871, MAS BT - TC

Art.	€	Taper	HSK
S007/30	€ 188,00	30 ISO	-
S007/40	€ 191,00	40 ISO	63
S007/50	€ 214,00	50 ISO	100



S014-

CHUCK HOLDER

VERTICAL AND HORIZONTAL FOR BT 40 AND ISO 40. IT'S A SMART DEVICE TO SET THE CHUCK FOR CNC MACHINES

Art.	€	Chuck sizes	Weight
S014/40BT	€ 66,10	BT 40 ISO 40	3,8 kg
S014/40DIN	€ 66,10	DIN 69871.40 ISO 40	3,8 kg
S014/50BT	€ 150,00	BT 50 ISO 50	11,4 kg
S014/50DIN	€ 150,00	DIN 69871.50 ISO 50	11,4 kg



16-CM

TAPER SHANK SHELL END MILL ADAPTER

DIN 228/A

Art.	€	d - h6	MT	F	H
16/CM3	€ 78,40	16 mm	3	M 12	40 mm
16/CM4	€ 78,40	16 mm	4	M 16	55 mm
22/CM3	€ 78,40	22 mm	3	M 12	50 mm
22/CM4	€ 78,40	22 mm	4	M 16	55 mm
27/CM3	€ 78,40	27 mm	3	M 12	50 mm
27/CM4	€ 78,40	27 mm	4	M 16	55 mm



3-CM

COLLET CHUCK

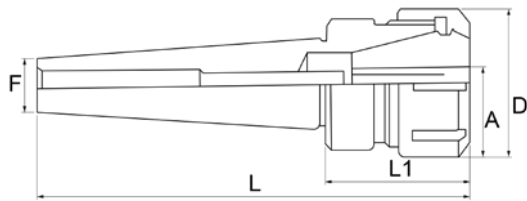

DIN 228/A

Art.	€	Collets	D	L	L1	F	A
3/CM2	€ 74,00	ER 32	50 mm	135 mm	60 mm	M 10	3 / 20 mm
3/CM3	€ 74,00	ER 32	50 mm	146 mm	60 mm	M 12	3 / 20 mm
3/CM4	€ 83,10	ER 32	50 mm	166 mm	58 mm	M 16	3 / 20 mm



3D40-

COLLET CHUCK

BALANCED CHUCK BODY

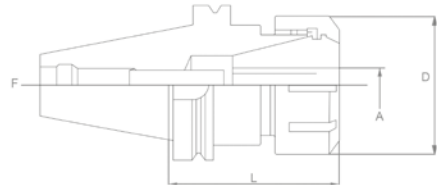

MAS - 403 BT

Art.	€	Collets	A	D	L	F	Balancing rpm
3D40/16	€ 59,20	ER 16	1 / 10 mm	28 mm	100 mm	M 16	12000
3D40/20	€ 59,20	ER 20	2 / 13 mm	34 mm	100 mm	M 16	12000
3D40/25	€ 59,20	ER 25	2 / 16 mm	42 mm	100 mm	M 16	12000
3/D/40	€ 93,60	ER 32	3/20 mm	50 mm	63 mm	M 16	12000



3A40-

COLLET CHUCK

BALANCED CHUCK BODY

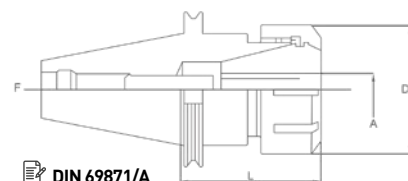

DIN 69871/A

Art.	€	Collets	A	D	L	F	Balancing rpm
3A40/16	€ 59,20	ER 16	1 / 10 mm	28 mm	100 mm	M 16	12000
3A40/20	€ 59,20	ER 20	2 / 13 mm	34 mm	100 mm	M 16	12000
3A40/25	€ 59,20	ER 25	2 / 16 mm	42 mm	100 mm	M 16	12000
3/A/40	€ 93,60	ER 32	3/20 mm	50 mm	72 mm	M 16	12000



3/B/40

COLLET CHUCK

BALANCED CHUCK BODY

€ 86,30

DIN 2080

Collets	ER 32
A	3/20 mm
D	50 mm
L	65 mm
F	M 16
Balancing rpm	2000

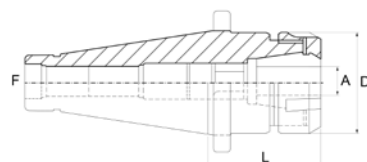

PR16/10P

€ 73,00

ER16 SPRING COLLET SET



10 Pcs

Sizes \varnothing 1-2-3-4-5-6-7-8-9-10 mm
Weight 0.5 kg

PR20/12P

€ 81,50

ER20 SPRING COLLET SET



12 Pcs

Sizes \varnothing 2-3-4-5-6-7-8-9-10-11-12-13 mm
Weight 0.9 kg



PR25/15P

€ 107,00

ER25 SPRING COLLET SET



15 Pcs

Sizes \varnothing 2-3-4-5-6-7-8-9-10-11-12-13-14-15-16 mm
Weight 1.68 kg

P032/7P

€ 98,70

ER32 SPRING COLLET SET



7 Pcs

Sizes 4-6-8-10-12-16-20 mm
Weight 1,1 kg

P032/18P

€ 206,00

ER32 SPRING COLLET SET



18 Pcs

Sizes 3-4-5-6-7-8-9-10-11-12-13-14-15-16-17-18-19-20 mm
Weight 3 kg

G0x

SPARE RING

Art.	€
G016	€ 7,90
G020	€ 8,70
G025	€ 11,90
G032	€ 29,80



CHERx

LOCK RING DRIVING KEY

Art.	€
CHER25	€ 12,70
CHER32	€ 16,20



P032-

SPRING COLLET

ER 32

Art.	€	Capacity A	D	L
P032/03	€ 12,00	2-3 mm	33 mm	40 mm
P032/04	€ 12,00	3-4 mm	33 mm	40 mm
P032/05	€ 12,00	4-5 mm	33 mm	40 mm
P032/06	€ 12,00	5-6 mm	33 mm	40 mm
P032/07	€ 12,00	6-7 mm	33 mm	40 mm
P032/08	€ 12,00	7-8 mm	33 mm	40 mm
P032/09	€ 12,00	8-9 mm	33 mm	40 mm
P032/10	€ 12,00	9-10 mm	33 mm	40 mm
P032/11	€ 12,00	10-11 mm	33 mm	40 mm

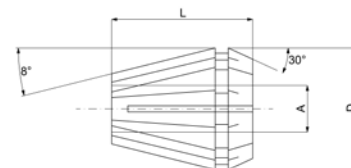

Art.	€	Capacity A	D	L
P032/12	€ 12,00	11-12 mm	33 mm	40 mm
P032/13	€ 12,00	12-13 mm	33 mm	40 mm
P032/14	€ 12,00	13-14 mm	33 mm	40 mm
P032/15	€ 12,00	14-15 mm	33 mm	40 mm
P032/16	€ 12,00	15-16 mm	33 mm	40 mm
P032/17	€ 12,00	16-17 mm	33 mm	40 mm
P032/18	€ 12,00	17-18 mm	33 mm	40 mm
P032/19	€ 12,00	18-19 mm	33 mm	40 mm
P032/20	€ 12,00	19-20 mm	33 mm	40 mm

COMPATIBILITY CHART

Art.	€	3/CM2	3/CM3	3/CM4	3/D/40	3/B/40	3/A/40	3A40/16	3A40/20	3A40/25	3D40/16	3D40/20	3D40/25	PAG
P032/03	12,00	*	*	*	*	*	*							167
P032/04	12,00	*	*	*	*	*	*							167
P032/05	12,00	*	*	*	*	*	*							167
P032/06	12,00	*	*	*	*	*	*							167
P032/07	12,00	*	*	*	*	*	*							167
P032/08	12,00	*	*	*	*	*	*							167
P032/09	12,00	*	*	*	*	*	*							167
P032/10	12,00	*	*	*	*	*	*							167
P032/11	12,00	*	*	*	*	*	*							167
P032/12	12,00	*	*	*	*	*	*							167
P032/13	12,00	*	*	*	*	*	*							167
P032/14	12,00	*	*	*	*	*	*							167
P032/15	12,00	*	*	*	*	*	*							167
P032/16	12,00	*	*	*	*	*	*							167
P032/17	12,00	*	*	*	*	*	*							167

Art.	€	3/CM2	3/CM3	3/CM4	3/D/40	3/B/40	3/A/40	3A40/16	3A40/20	3A40/25	3D40/16	3D40/20	3D40/25	PAG
P032/18	12,00	*	*	*	*	*	*							167
P032/19	12,00	*	*	*	*	*	*							167
P032/20	12,00	*	*	*	*	*	*							167
P032/7P	98,70	*	*	*	*	*	*							167
P032/18P	206,00	*	*	*	*	*	*							167
G032	29,80	*	*	*	*	*	*							167
CHER32	16,20	*	*	*	*	*	*							167
PR16/10P	73,00							*			*			166
PR20/12P	81,50								*			*		167
PR25/15P	107,00									*			*	167
G016	7,90							*			*			167
G020	8,70								*			*		167
G025	11,90									*			*	167
CHER25	12,70									*			*	167



P450

€ 445,00

TOOL ROLLING CABINET KIT
WITH 20 ISO50 TOOL HOLDERS



Overall sizes 950 x 650 x 830h mm
Weight 35 kg

P350

€ 155,00

TOOL ROLLING CABINET KIT
FRAME WITH 15 ISO50 TOOL HOLDERS

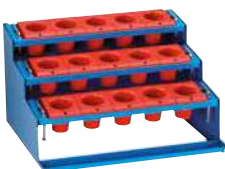

Overall sizes 600 x 500 x 350h mm
Weight 13 kg

PC50

€ 42,60

TOOL HOLDER SHELFS
WITH 5 ISO50 TOOL HOLDER



Overall sizes 600 x 145 mm

PC50/R

€ 45,10

TOOL HOLDER SET
ISO50



10 Pcs

Overall sizes 136 x 102 mm

P4CS

€ 16,80

COUPLE OF SUPPORTS
FOR TOOL ROLLING CABINET



P440

€ 400,00

TOOL ROLLING CABINET KIT
WITH 28 TOOL HOLDERS



Overall sizes 950 x 650 x 830h mm
Weight 35 kg

P340

€ 160,00

TABLE TOOL RACK KIT
FRAME WITH 21 ISO40 TOOL HOLDERS



Overall sizes 600 x 500 x 350h mm
Weight 13 kg

PC40

€ 42,60

TOOL HOLDER SHELFS
WITH 7 ISO40 TOOL HOLDERS



Overall sizes 600 x 145 mm

PC40/R

€ 42,00

TOOL HOLDER SET
ISO40



10 Pcs

Overall sizes 136 x 72 mm

PC4P

€ 18,00

4 FEET SET
FOR TOOL HOLDER SHELF



T010-

PRECISION BORING HEAD

TOOL KIT NOT INCLUDED



Art.	€	Boring head body	Shank	Tools	Max offset	A	Weight
T010/5003	€ 222,00	Ø 50 mm	CM/MT3-DIN228A	Ø 12 mm	15 mm	75 mm	1,2 kg
T010/5004	€ 222,00	Ø 50 mm	CM/MT4-DIN228A	Ø 12 mm	15 mm	75 mm	1,8 kg
T010/5040	€ 222,00	Ø 50 mm	ISO 40-DIN2080	Ø 12 mm	15 mm	81 mm	1,9 kg
T010/7540	€ 254,00	Ø 75 mm	ISO 40-DIN2080	Ø 18 mm	25 mm	99 mm	3,2 kg

T021-

AUTOMATIC PRECISION BORING HEAD

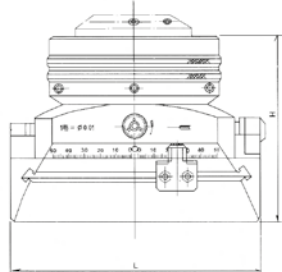
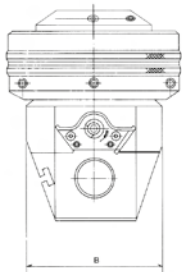

Art.	€
T021/030	€ 1590,00
T021/030CM3	€ 1590,00
T021/050	€ 1850,00
T021/100	€ 2140,00
T021/100/50	€ 2140,00

	T021/030 T021/030CM3	T021/050	T021/100 T021/100/50
Max facing and boring ø	150 mmv	350 mm	450 mm
Max stroke of slide	± 15 mm	± 25 mm	± 50 mm
Fine feed per graduation	0,005 mm	0,005 mm	0,005 mm
Manual feed per revolution	2 mm	3 mm	3 mm
Self acting feed per revolution	0,02-0,04-0,06 0,08-0,10-0,12 mm	0,03-0,06-0,09 0,12-0,15-0,18 mm	0,03-0,06-0,09 0,12-0,15-0,18 mm
ø of tool post holes in head	18 mm	22 mm	22 mm
Max ø of head	90 mm	120 mm	168 mm
Height of head without shank - (H)	87,5 mm	118 mm	118 mm
Weight of head without shank	2,9 kg	6,1 kg	7,8 kg
Length of sliding block	75 mm	105 mm	160 mm
Width of sliding block	70 mm	90 mm	90 mm
Collets hole	4 - 8 - 12 mm	8 - 10 - 12 - 14 mm	8 - 10 - 12 - 14 mm
Accessories	1 - 2 - 6	1 - 2 - 3 - 4 - 5	1 - 2 - 3 - 4 - 5
Extension hole for tool holder	Ø 6 mm	Ø 10 mm	Ø 10 mm

B001-

SOLID BORING BAR SET FOR PRECISION BORING HEADS

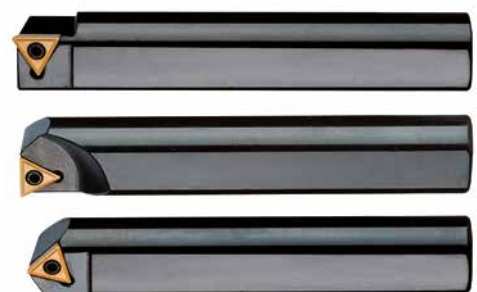

Art.	€	Suitable	Shank	Length	Insert (not included)
B001/12	€ 103,00	T010/50	12 ø mm	60 mm	TCMT110204N
B001/18	€ 103,00	T010/75	18 ø mm	99 mm	TCMT110204N

HOW TO CHOOSE YOUR TOOL POST

LATHE CENTERS HEIGHT	TOOL POST TYPE
90 mm	A0
120 mm	A1
140 mm	A
150 - 200 mm	E
200 - 250 mm	B
250 - 350 mm	C



0688

€ 167,00

LATHE MILL TABLE UNIVERSAL DEVICE

L1	52 mm
L2	80 mm
L3	65 mm
L4	220 mm
L5	37 mm
L6	110 mm
L8	46 mm
L9	150 mm

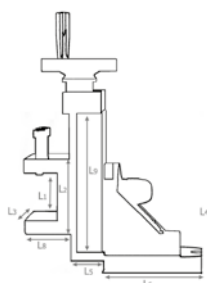

T00x

QUICK CHANGE TOOL POST

TOOL HOLDERS ADJUSTMENT IN 40 DIFFERENT ANGLES - COMPOSED OF: 1 TOOL POST 3 FLAT TYPE TOOL HOLDERS 1 BORING BAR TOOL HOLDER

Art.	€	R max	S max	P	T	H	X min
T00A	€ 679,00	100 mm	54 mm	48 mm	20 mm	16 mm	30 mm
T00B	€ 865,00	150 mm	75 mm	71 mm	32 mm	25 mm	37 mm
T00C	€ 1390,00	202 mm	105 mm	102 mm	40 mm	32 mm	47 mm
T00E	€ 718,00	125 mm	68 mm	60 mm	20 mm	20 mm	35 mm

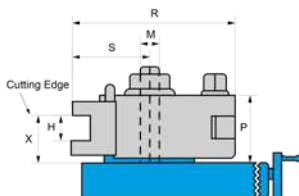

T00x-D

FLAT TYPE TOOL HOLDERS

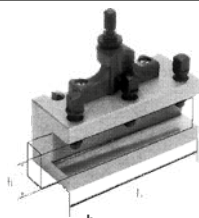

Art.	€	L	h
T00A/D	€ 96,10	80 mm	16 mm
T00B/D	€ 144,00	120 mm	25 mm
T00C/D	€ 222,00	150 mm	32 mm
T00E/D	€ 129,00	100 mm	20 mm

T00x-B

PRISMATIC TYPE TOOL HOLDERS

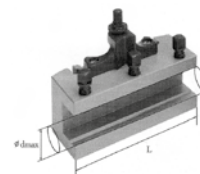

Art.	€	L	d max
T00A/B	€ 100,00	80 mm	20 mm
T00B/B	€ 148,00	130 mm	32 mm
T00C/B	€ 219,00	160 mm	32 mm
T00E/B	€ 144,00	100 mm	30 mm

T00x-S

TOOL HOLDERS FOR SOCKET

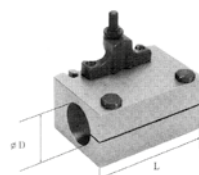

Art.	€	L	D
T00A/S	€ 110,00	80 mm	30 mm
T00B/S	€ 182,00	120 mm	40 mm
T00C/S	€ 257,00	150 mm	40 mm
T00E/S	€ 148,00	100 mm	30 mm

T00x-LC

REDUCTION SLEEVE

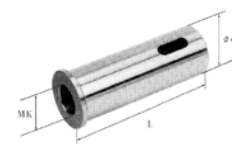

Art.	€	L	d	MT
T00AE/LCM1	€ 32,00	80 mm	30 mm	1
T00AE/LCM2	€ 32,00	95 mm	30 mm	2
T00BC/LCM2	€ 34,60	105 mm	36 mm	2
T00BC/LCM3	€ 34,60	120 mm	40 mm	3
T00BC/LCM4	€ 53,30	150 mm	40 mm	4

TOAx

QUICK CHANGE TOOL POST

COMPOSED OF: - 1 TOOL POST - 4 FLAT TYPE TOOL HOLDERS

Art.	€	Length	Width	Working height	Hole	Tool height
TOAA	€ 227,00	57 mm	64 mm	56 mm	14,4 mm	14 mm
TOAB	€ 382,00	85 mm	85 mm	76 mm	19,9 mm	20 mm
TOAC	€ 492,00	100 mm	100 mm	92 mm	22,22 mm	25 mm
TOAE	€ 288,00	76,5 mm	76,5 mm	70 mm	16,5 mm	16 mm



TOAx-D

FLAT TYPE TOOL HOLDERS

Art.	€	Length	Width	Height	Tool height
TOAA/D	€ 52,30	76 mm	25,5 mm	38 mm	14 mm
TOAB/D	€ 73,20	108 mm	35 mm	54 mm	20 mm
TOAC/D	€ 85,50	125 mm	40 mm	63 mm	25 mm
TOAE/D	€ 62,70	89 mm	29 mm	45 mm	16 mm



T00A1

€ 218,00

QUICK CHANGE TOOL POST

COMPOSED OF: - 1 TOOL POST - 3 FLAT TYPE TOOL HOLDERS

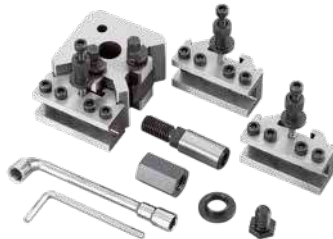

Length	57 mm
Width	57 mm
Height	37 mm
Hole	16
Tool height	14 mm

T00A1/PP

€ 43,90

FLAT TYPE TOOL HOLDERS



Length	57 mm
Width	25 mm
Height	25 mm
Tool height	12 mm

TO0Ax

QUICK CHANGE TOOL POST

COMPOSED OF: - 1 TOOL POST - 3 FLAT TYPE TOOL HOLDERS

Art.	€	Length	Width	Height	Hole	Tool height
T00A0	€ 101,00	60 mm	50 mm	30 mm	10	12 mm
T00A1R	€ 134,00	68 mm	68 mm	47 mm	10 mm	19 mm



T00Ax-PP

FLAT TYPE TOOL HOLDERS

Art.	€	Length	Width	Height	Tool height
T00A0/PP	€ 31,70	50 mm	22 mm	24 mm	12 mm
T00A1R/PP	€ 32,50	66 mm	27 mm	46 mm	19 mm



M038

CAT. 42 € 542,00

CROSS FEED MOTOR

X-AXIS, HORIZONTAL POSITION OF THE MOTOR, SPEED ADJUSTMENT AND QUICK TRAVEL



Round speed	0 ÷ 200 rpm
Torque	5,1 Nm
Single-phase motor	230 V 50 Hz 0,1 kW
Weight	12 kg



P018-

COOLING SYSTEM FOR MACHINES



Art.	€	Power	Tank capacity	Pump capacity	Weight
P018/230V	€ 282,00	230V - 50Hz - 40W	10 l	22 l/min	7 kg
P018/400V	€ 282,00	400V - 50Hz - 40W	10 l	22 l/min	7 kg

T200

€ 13,80

COOLING HOSE

COMPOSED OF: N. 21 SEGMENTS N. 1 NOZZLE: HOLE Ø 1,5 mm N. 1 NOZZLE: HOLE Ø 3 mm N. 1 FITTING: 1/8" N. 1 FITTING: 1/4" N. 1 PLAIN NOZZLE

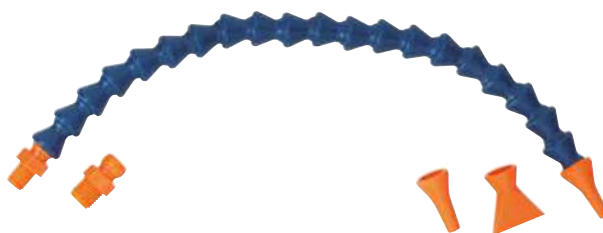

Total length	350 mm
Hose diameter	6 mm - 1/4"

T201

€ 15,10

COOLING HOSE

COMPOSED OF: N. 16 SEGMENTS N. 1 NOZZLE - HOLE: Ø 5 mm N. 1 FITTING 1/2" N. 1 PLAIN NOZZLE



Total length	400 mm
Hose diameter	12 mm - 1/2"

T338-

CHROMED METAL JOINTED TUBE FOR REFRIGERATING LIQUIDS



Art.	€	Total length	Thread
T338/500	€ 14,30	500 mm	3/8"
T338/600	€ 15,80	600 mm	3/8"

Tx

LATH E CHUCK SAFETY GUARD STEEL FRAME WITH LEXAN SCREEN



Art.	€	Overall sizes
T400	€ 150,00	Ø 400 x 200 mm
T500	€ 159,00	Ø 500 x 220 mm
T600	€ 173,00	Ø 600 x 280 mm

P100/250

€ 100,00

MACHINE TOOL SAFETY GUARD

WITH SAFETY MICROSWITCH, ADJUSTABLE HEIGHT



Shank	400 mm
Shield	150x250 H x L mm

S100

€ 46,70

BENCH GRINDER SAFETY GUARD WITH LEXAN SCREEN



Overall sizes	110 x 120 mm
---------------	--------------

Mx

UNIVERSAL SUPPORT UNIT FOR LATHE WITH CHUCK SAFETY GUARD WITH MICROSWITCH



Art.	€	Shank	Length
M400	€ 188,00	Ø 30 mm	350 mm
M500	€ 195,00	Ø 30 mm	400 mm
M600	€ 203,00	Ø 30 mm	450 mm

P101-

MACHINE TOOL SAFETY GUARD

ADJUSTABLE AND TILTING HEIGHT, LEXAN SCREEN, SAFETY MICROSWITCH



Art.	€	Shank	Shield
P101/300	€ 322,00	400L mm	150 x 350 H x L mm
P101/350	€ 339,00	600L mm	200 x 440 H x L mm
P101/400	€ 349,00	500L mm	150 x 370 H x L mm



0531A

CAT. 42 € 123,00

LED LIGHT MACHINE OPERATION LAMP

WITHOUT TRANSFORMER

IP 65

Power	12 - 24 V 13 W
Height	110 mm
Diameter	125 mm
Joints	1
Dust and water proof	IP 65
Net weight	1,6 kg
Weight	1,7 kg



0532A

CAT. 42 € 150,00

LED LIGHT MACHINE OPERATION LAMP

WITHOUT TRANSFORMER

IP 65

Power	12 - 24 V 13 W
Height	890 mm
Diameter	125 mm
Joints	3
Dust and water proof	IP 65
Net weight	2 kg
Weight	2,1 kg



0532A/230V

CAT. 42 € 163,00

LED LIGHT MACHINE OPERATION LAMP

WITH TRANSFORMER

IP 65

Power	230 V 50 Hz 13 W
Height	900 mm
Diameter	125 mm
Joints	3
Dust and water proof	IP 65
Net weight	2,2 kg
Weight	2,3 kg



0371

€ 130,00

LED LIGHT MACHINE OPERATION LAMP

W.O. TRANSFORMER

IP 65

Power	24V 10W
Joint height	110 mm
Diameter	110 mm
Joints	1
Dust and water proof	IP 65
Weight	1,7 kg



0372

€ 197,00

LED LIGHT MACHINE OPERATION LAMP

W.O. TRANSFORMER

IP 65

Power	24V 10W
Height	890 mm
Diameter	110 mm
Joints	3
Dust and water proof	IP 65
Weight	2,1 kg



0537A

CAT. 42 € 90,10

LED LICHT MASCHINEN BETRIEBSLAMPE

WITHOUT TRANSFORMER

IP 44

Power	12 - 24 V 7 W
Height	100 mm
Diameter	90 mm
Joints	1
Dust and water proof	IP 44
Weight	1,5 kg



0538A

CAT. 42 € 112,00

LED LIGHT MACHINE OPERATION LAMP

WITHOUT TRANSFORMER

IP 44

Power	12 - 24 V 7 W
Height	650 mm
Diameter	90 mm
Joints	3
Dust and water proof	IP 44
Weight	2,0 kg



0536

€ 61,40

MACHINE TOOL OPERATION LAMP

FLEXIBLE LAMP WITH MAGNETIC BASE

IP 44

Height max	620 mm
Dust and water proof	IP 40
With transformer	230 V / 24 V 25 W



B007-

INDEXABLE CARBIDE TOOL HOLDER SET

INSERT INCLUDED



Art.	€	Ext. shank / Insert	Int. shank / Insert
B007/10	€ 93,60	10 mm / TCMT110204N	8 mm / TCMT090204N
B007/12	€ 98,70	12 mm / TCMT110204N	10 mm / TCMT110204N
B007/16	€ 122,00	16 mm / TCMT16T304N	12 mm / TCMT110204N

KITCKJ

EXTERNAL TOOL HOLDER WITH INSERTS



Art.	€	Set composition
KITCKJ20	€ 147,00	CKJNR20 + 10 KNUX160405RN
KITCKJ25	€ 149,00	CKJNR25 + 10 KNUX160405RN

STGCx

90° EXTERNAL TOOL HOLDER



Art.	€	Side	Shank	Capacity	Bushing	Base	Insert (not included)
STGCR16/11	€ 38,00	Dx/R	16 x 16 mm	T8 / M2,5 mm	-----	-----	TCMT110204N
STGCL16/11	€ 38,00	Sx/L	16 x 16 mm	T8 / M2,5 mm	-----	-----	TCMT110204N
STGCR20	€ 42,90	Dx/R	20 x 20 mm	T15 / M3,5 mm	BU3550	BSTG16	TCMT16T304N - TCMT16T308N
STGCL20	€ 42,90	Sx/L	20 x 20 mm	T15 / M3,5 mm	BU3550	BSTG16	TCMT16T304N - TCMT16T308N
STGCR25	€ 52,70	Dx/R	25 x 25 mm	T15 / M3,5 mm	BU3550	BSTG16	TCMT16T304N - TCMT16T308N
STGCL25	€ 52,70	Sx/L	25 x 25 mm	T15 / M3,5 mm	BU3550	BSTG16	TCMT16T304N - TCMT16T308N

SCLCxE

95° EXTERNAL TOOL HOLDER



Art.	€	Side	Shank	Capacity	Bushing	Base	Insert (not included)
SCLCR12E	€ 32,50	Dx/R	12 x 12 mm	T15 / M4,0 mm	-----	-----	CCMT09T304N - CCMT09T308N
SCLCL12E	€ 32,50	Sx/L	12 x 12 mm	T15 / M4,0 mm	-----	-----	CCMT09T304N - CCMT09T308N
SCLCR16E	€ 39,30	Dx/R	16 x 16 mm	T15 / M4,0 mm	BU4560	BSCL09	CCMT09T304N - CCMT09T308N
SCLCL16E	€ 39,30	Sx/L	16 x 16 mm	T15 / M4,0 mm	BU4560	BSCL09	CCMT09T304N - CCMT09T308N
SCLCR20E	€ 43,90	Dx/R	20 x 20 mm	T15 / M4,5 mm	BU4560	BSCL12	CCMT120408N
SCLCL20E	€ 43,90	Sx/L	20 x 20 mm	T15 / M4,5 mm	BU4560	BSCL12	CCMT120408N
SCLCR25E	€ 52,70	Dx/R	25 x 25 mm	T15 / M4,5 mm	BU4560	BSCL12	CCMT120408N
SCLCL25E	€ 52,70	Sx/L	25 x 25 mm	T15 / M4,5 mm	BU4560	BSCL12	CCMT120408N

SSSCxE

45° EXTERNAL TOOL HOLDER



Art.	€	Side	Shank	Capacity	Bushing	Base	Insert (not included)
SSSCR20E	€ 42,90	Dx/R	20 x 20 mm	T15 / M4,0 mm	BU4560	BSSS12	SCMT120408N
SSSCL20E	€ 42,90	Sx/L	20 x 20 mm	T15 / M4,0 mm	BU4560	BSSS12	SCMT120408N
SSSCR25E	€ 55,30	Dx/R	25 x 25 mm	T15 / M4,5 mm	BU4560	BSSS12	SCMT120408N
SSSCL25E	€ 55,30	Sx/L	25 x 25 mm	T15 / M4,5 mm	BU4560	BSSS12	SCMT120408N

SVJBx

93° EXTERNAL TOOL HOLDER



Art.	€	Side	Shank	Capacity	Bushing	Base	Insert (not included)
SVJBR20	€ 42,90	Dx/R	20 x 20 mm	T15 / M3,5 mm	BU3550	BSVJ16	VBMT160404N - VBMT160408N
SVJBL20	€ 42,90	Sx/L	20 x 20 mm	T15 / M3,5 mm	BU3550	BSVJ16	VBMT160404N - VBMT160408N
SVJBR25	€ 55,30	Dx/R	25 x 25 mm	T15 / M3,5 mm	BU3550	BSVJ16	VBMT160404N - VBMT160408N
SVJBL25	€ 55,30	Sx/L	25 x 25 mm	T15 / M3,5 mm	BU3550	BSVJ16	VBMT160404N - VBMT160408N

SDJCx

93° EXTERNAL TOOL HOLDER



Art.	€	Side	Shank	Capacity	Bushing	Base	Insert (not included)
SDJCR10	€ 24,70	Dx/R	10 x 10 mm	T8 / M2,5 mm	-----	-----	DCMT070204N
SDJCR12	€ 35,50	Dx/R	12 x 12 mm	T8 / M2,5 mm	-----	-----	DCMT070204N
SDJCR16	€ 40,90	Dx/R	16 x 16 mm	T8 / M2,5 mm	-----	-----	DCMT070204N
SDJCR20	€ 46,30	Dx/R	20 x 20 mm	T15 / M3,5 mm	BU4050	BSDJ11	DCMT11T304N
SDJCL20	€ 46,30	Sx/L	20 x 20 mm	T15 / M3,5 mm	BU4050	BSDJ11	DCMT11T304N
SDJCR25	€ 58,70	Dx/R	25 x 25 mm	T15 / M3,5 mm	BU4050	BSDJ11	DCMT11T304N
SDJCL25	€ 58,70	Sx/L	25 x 25 mm	T15 / M3,5 mm	BU4050	BSDJ11	DCMT11T304N

PCLNx

EXTERNAL TOOL HOLDER

95°



Art.	€	Side	Shank	Angle	Insert (not included)
PCLNR16	€ 35,60	R	16 x 16 mm	95°	CNMG120408N
PCLNR20	€ 46,60	Dx/R	20 x 20 mm	95°	CNMG120408N
PCLNL20	€ 46,60	Sx/L	20 x 20 mm	95°	CNMG120408N
PCLNR25	€ 55,30	Dx/R	25 x 25 mm	95°	CNMG120408N
PCLNL25	€ 55,30	Sx/L	25 x 25 mm	95°	CNMG120408N

PTGNx

EXTERNAL TOOL HOLDER

90°



Art.	€	Side	Shank	Angle	Insert (not included)
PTGNR16	€ 35,60	R	16 x 16 mm	90°	TNMG160408N
PTGNR20	€ 43,50	Dx/R	20 x 20 mm	90°	TNMG160408N
PTGNL20	€ 43,50	Sx/L	20 x 20 mm	90°	TNMG160408N
PTGNR25	€ 55,30	Dx/R	25 x 25 mm	90°	TNMG160408N
PTGNL25	€ 55,30	Sx/L	25 x 25 mm	90°	TNMG160408N

PSSNx

EXTERNAL TOOL HOLDER

45°



Art.	€	Side	Shank	Angle	Insert (not included)
PSSNR16	€ 35,60	R	16 x 16 mm	45°	SNMG120408N
PSSNR20	€ 43,90	Dx/R	20 x 20 mm	45°	SNMG120408N
PSSNL20	€ 43,90	Sx/L	20 x 20 mm	45°	SNMG120408N
PSSNR25	€ 55,30	Dx/R	25 x 25 mm	45°	SNMG120408N
PSSNL25	€ 55,30	Sx/L	25 x 25 mm	45°	SNMG120408N

CKJNx

EXTERNAL TOOL HOLDER

93°



Art.	€	Side	Shank	Angle	Insert (not included)
CKJNL20	€ 52,70	Sx/L	20 x 20 mm	93°	KNUX160405LN
CKJNL25	€ 61,20	Sx/L	25 x 25 mm	93°	KNUX160405LN
CKJNR16	€ 43,50	R	16 x 20 mm	93°	KNUX160405RN
CKJNR20	€ 52,70	Dx/R	20 x 20 mm	93°	KNUX160405RN
CKJNR25	€ 61,20	Dx/R	25 x 25 mm	93°	KNUX160405RN

PDJNx

EXTERNAL TOOL HOLDER

93°



Art.	€	Side	Shank	Angle	Insert (not included)
PDJNR20	€ 45,10	Dx/R	20 x 20 mm	93°	DNMG150608N
PDJNR25	€ 55,30	Dx/R	25 x 25 mm	93°	DNMG150608N
PDJNL25	€ 55,30	Sx/L	25 x 25 mm	93°	DNMG150608N

PWLNx

EXTERNAL TOOL HOLDER

95°



Art.	€	Side	Shank	Angle	Insert (not included)
PWLN20	€ 45,10	Dx/R	20 x 20 mm	95°	WNMG080408N
PWLN25	€ 55,30	Dx/R	25 x 25 mm	95°	WNMG080408N
PWLN25	€ 55,30	Sx/L	25 x 25 mm	95°	WNMG080408N

G007-

KNURLING TOOL WITH 3 PAIRS OF KNURLING WHEELS, WITH DIAMOND PATTERN



Art.	€	Shank	Pitch
G007/16	€ 63,30	16 mm	0,8 - 1,2 - 1,8 mm
G007/20	€ 64,20	20 mm	0,8 - 1,2 - 1,8 mm

KISCLCR

€ 197,00

SOLID BORING BAR SET 95°

COMPOSED OF: 1PC. INT. TOOL HOLDER: SCLCR08; SCLCR10; SCLCR12; CLCR16 1PC. SCREW: T8 Ø 2,5 mm 2PCS TORX KEY: T8 10PCS INSERT: CCMT060204N



KISTCMT

€ 232,00

SOLID BORING BAR SET 90°



Int. tool holder	STFCR08; STFCR10; STFCR12; STFCR16; STFCR20
Screw	T8 Ø 2,5 mm
Torx key	T8 x 2 Pz / Pcs
Insert	TCMT110204N x 10 Pz / Pcs

KISTFCR

€ 183,00

SOLID BORING BAR SET 90°

COMPOSED OF STFCR08, STFCR10, STFCR12, STFCR16, STFCR20 INTERNAL TOOLS (1PC FOR EACH ONE), SPARE PART SCREWS 2.5MM (5PCS) AND T8 TORX KEYS (2PCS)



STFCR08 Dimensions	Ø 8 x 100 mm
STFCR10 Dimensions	Ø10 x 125 mm
STFCR12 Dimensions	Ø12 x 150 mm
STFCR16 Dimensions	Ø16 x 200 mm
STFCR20 Dimensions	Ø20 x 250 mm
Spare screws T8 Dimensions	Ø2,5 x 6 mm

SSSCRx

INTERNAL TOOL HOLDER



Art.	€	Overall sizes	Insert (not included)
SSSCR16	€ 42,20	Ø 16 mm, L 200 mm	SCMT09T304N - SCMT09T308N
SSSCR20	€ 47,00	Ø 20 mm, L 250 mm	SCMT09T304N - SCMT09T308N
SSSCR25	€ 55,30	Ø 25 mm, L 300 mm	SCMT09T304N - SCMT09T308N

SCLCx

SOLID BORING BAR

95°



Art.	€	Side	D	h	L	Insert (not included)
SCLCR08	€ 50,00	Dx/R	8 mm	7 mm	125 mm	CCMT060204N
SCLCL08	€ 50,00	Sx/L	8 mm	7 mm	125 mm	CCMT060204N
SCLCR10	€ 50,00	Dx/R	10 mm	9 mm	140 mm	CCMT060204N
SCLCL10	€ 50,00	Sx/L	10 mm	9 mm	140 mm	CCMT060204N
SCLCR12	€ 50,00	Dx/R	12 mm	11 mm	160 mm	CCMT060204N
SCLCL12	€ 50,00	Sx/L	12 mm	11 mm	160 mm	CCMT060204N
SCLCR16	€ 56,70	Dx/R	16 mm	14,5 mm	180 mm	CCMT09T304N
SCLCL16	€ 56,70	Sx/L	16 mm	14,5 mm	180 mm	CCMT09T304N
SCLCR20	€ 56,70	Dx/R	20 mm	18 mm	200 mm	CCMT09T304N
SCLCL20	€ 56,70	Sx/L	20 mm	18 mm	200 mm	CCMT09T304N
SCLCR25	€ 63,30	Dx/R	25 mm	22,5 mm	250 mm	CCMT09T304N
SCLCL25	€ 63,30	Sx/L	25 mm	22,5 mm	250 mm	CCMT09T304N
SCLCR32	€ 89,30	Dx/R	32 mm	29 mm	300 mm	CCMT09T304N
SCLCL32	€ 89,30	Sx/L	32 mm	29 mm	300 mm	CCMT09T304N

STFCx
SOLID BORING BAR

90°



Art.	€	Side	D	h	L	Insert (not included)
STFCR08	€ 50,00	Dx/R	8 mm	7 mm	125 mm	TCMT110204N
STFCL08	€ 50,00	Sx/L	8 mm	7 mm	125 mm	TCMT110204N
STFCR10	€ 50,00	Dx/R	10 mm	9 mm	150 mm	TCMT110204N
STFCL10	€ 50,00	Sx/L	10 mm	9 mm	150 mm	TCMT110204N
STFCR12	€ 50,00	Dx/R	12 mm	11 mm	150 mm	TCMT110204N
STFCL12	€ 50,00	Sx/L	12 mm	11 mm	150 mm	TCMT110204N
STFCR16	€ 56,70	Dx/R	16 mm	14,5 mm	200 mm	TCMT110204N
STFCL16	€ 56,70	Sx/L	16 mm	14,5 mm	200 mm	TCMT110204N
STFCR20	€ 56,70	Dx/R	20 mm	18,5 mm	250 mm	TCMT110204N
STFCL20	€ 56,70	Sx/L	20 mm	18,5 mm	200 mm	TCMT110204N
STFCR25	€ 63,30	Dx/R	25 mm	22,5 mm	250 mm	TCMT16T304N
STFCL25	€ 63,30	Sx/L	25 mm	22,5 mm	250 mm	TCMT16T304N
STFCR32	€ 89,30	Dx/R	32 mm	29 mm	300 mm	TCMT16T304N
STFCL32	€ 89,30	Sx/L	32 mm	29 mm	300 mm	TCMT16T304N

SDUCx
SOLID BORING BAR

93°



Art.	€	Side	D	h	L	Insert (not included)
SDUCR10	€ 50,00	Dx/R	10 mm	9 mm	140 mm	DCMT070204N
SDUCL10	€ 50,00	Sx/L	10 mm	9 mm	140 mm	DCMT070204N
SDUCR12	€ 50,00	Dx/R	12 mm	11 mm	160 mm	DCMT070204N
SDUCL12	€ 50,00	Sx/L	12 mm	11 mm	160 mm	DCMT070204N
SDUCR16	€ 56,70	Dx/R	16 mm	15 mm	180 mm	DCMT070204N
SDUCL16	€ 56,70	Sx/L	16 mm	15 mm	180 mm	DCMT070204N
SDUCR20	€ 56,70	Dx/R	20 mm	18 mm	200 mm	DCMT11T304N
SDUCL20	€ 56,70	Sx/L	20 mm	18 mm	200 mm	DCMT11T304N
SDUCR25	€ 63,30	Dx/R	25 mm	23 mm	250 mm	DCMT11T304N
SDUCL25	€ 63,30	Sx/L	25 mm	23 mm	250 mm	DCMT11T304N
SDUCR32	€ 89,30	Dx/R	32 mm	30 mm	300 mm	DCMT11T304N
SDUCL32	€ 89,30	Sx/L	32 mm	30 mm	300 mm	DCMT11T304N

MCLNx
SOLID BORING BAR

95°



Art.	€	Side	D	h	L	Insert (not included)
MCLNR16	€ 65,10	Dx/R	16 mm	15 mm	210 mm	CNMG120404N
MCLNL16	€ 65,10	Sx/L	16 mm	15 mm	210 mm	CNMG120404N
MCLNR20	€ 71,80	Dx/R	20 mm	18 mm	255 mm	CNMG120404N
MCLNL20	€ 71,80	Sx/L	20 mm	18 mm	255 mm	CNMG120404N
MCLNR25	€ 91,00	Dx/R	25 mm	23 mm	300 mm	CNMG120404N
MCLNL25	€ 91,00	Sx/L	25 mm	23 mm	300 mm	CNMG120404N
MCLNR32	€ 111,00	Dx/R	32 mm	30 mm	355 mm	CNMG120404N
MCLNL32	€ 111,00	Sx/L	32 mm	30 mm	355 mm	CNMG120404N

MTFNx

SOLID BORING BAR

90°



Art.	€	Side	D	h	L	Insert (not included)
MTFNR16	€ 64,20	Dx/R	16 mm	15 mm	210 mm	TNMG160404N
MTFNL16	€ 64,20	Sx/L	16 mm	15 mm	210 mm	TNMG160404N
MTFNR20	€ 71,80	Dx/R	20 mm	18 mm	255 mm	TNMG160404N
MTFNL20	€ 71,80	Sx/L	20 mm	18 mm	255 mm	TNMG160404N
MTFNR25	€ 91,00	Dx/R	25 mm	23 mm	300 mm	TNMG160404N
MTFNL25	€ 91,00	Sx/L	25 mm	23 mm	300 mm	TNMG160404N
MTFNR32	€ 111,00	Dx/R	32 mm	30 mm	355 mm	TNMG160404N
MTFNL32	€ 111,00	Sx/L	32 mm	30 mm	355 mm	TNMG160404N



CTFPx

SOLID BORING BAR

90°



Art.	€	Side	D	h	L	Insert (not included)
CTFPR10	€ 54,80	Dx/R	10 mm	9 mm	150 mm	TPMR090204N
CTFPL10	€ 54,80	Sx/L	10 mm	9 mm	150 mm	TPMR090204N
CTFPR12	€ 54,80	Dx/R	12 mm	11 mm	150 mm	TPMR110304N
CTFPL12	€ 54,80	Sx/L	12 mm	11 mm	150 mm	TPMR110304N
CTFPR16	€ 63,30	Dx/R	16 mm	15 mm	210 mm	TPMR110304N
CTFPL16	€ 63,30	Sx/L	16 mm	15 mm	210 mm	TPMR110304N
CTFPR20	€ 71,80	Dx/R	20 mm	18 mm	255 mm	TPMR160304N
CTFPL20	€ 71,80	Sx/L	20 mm	18 mm	255 mm	TPMR160304N
CTFPR25	€ 88,40	Dx/R	25 mm	23 mm	300 mm	TPMR160304N
CTFPL25	€ 88,40	Sx/L	25 mm	23 mm	300 mm	TPMR160304N
CTFPR32	€ 111,00	Dx/R	32 mm	30 mm	355 mm	TPMR160304N
CTFPL32	€ 111,00	Sx/L	32 mm	30 mm	355 mm	TPMR160304N

CKUNR

SOLID BORING BAR

93°



Art.	€	Side	D	h	L	Insert (not included)
CKUNR25	€ 145,00	Dx/R	25 mm	23 mm	300 mm	KNUX160405LN
CKUNR32	€ 165,00	Dx/R	32 mm	30 mm	350 mm	KNUX160405LN
CKUNR40	€ 173,00	Dx/R	40 mm	37 mm	400 mm	KNUX160405LN

KISER

EXTERNAL THREAD TOOL HOLDER

COMPOSED OF: 1 PC EXTERNAL TOOL HOLDER 1 PC SCREW: M3.5 X 12 mm 1 PC HEX KEY: 2,5 mm 1 PC TORX KEY: T15 10 PCS DIFFERENT SIZE INSERTS: (1PZ.) AG55 - AG60; - ISO 0.8 - 1.00 - 1.25 - 1.50 - 1.75 - 2.00 - 2.50 - 3.00 mm



Art.	€	Shank	L	Insert
KISER	€ 155,00	20 x 20 mm	125 mm	16ER...
KISER25	€ 204,00	25 x 25 mm	150 mm	16ER...

KISNR

INTERNAL THREAD TOOL HOLDER

COMPOSED OF: 1PC INTERNAL TOOL HOLDER 1PC SCREW: M3.5 X 12 mm 1PC HEX KEY: 2,5 mm 1PC TORX KEY: T15 10PCS DIFFERENT SIZE INSERTS: (1PZ.) AG55 - AG60; - ISO 0.8 - 1.00 - 1.25 - 1.50 - 1.75 - 2.00 - 2.50 - 3.00 mm



Art.	€	ø	h	L	Insert
KISNR	€ 179,00	20 mm	18 mm	170 mm	16IR...
KISNR25	€ 213,00	25 mm	23 mm	200 mm	16IR...

KICAN

€ 199,00

INTERNAL AND EXTERNAL GROOVING TOOL HOLDER SET

1 PC EXT. GROOVING TOOL HOLDER: 20 X 20 mm 1 PC INT. GROOVING TOOL HOLDER: Ø 20 mm 2 PC SCREW: M4 X 12 mm - 1 PC TORX KEY: T 15 GROOVING INSERTS 16 mm TIN: 2 PCS 165110134 - 2 PCS 165130134 2 PCS 165160134 - 1 PC 165185134 1 PC 165215134 - 1 PC 165265134 1 PC 165315134



SERx

EXTERNAL THREAD TOOL HOLDER

FOR INDEXABLE CARBIDE INSERTS



Art.	€	Shank	L	Insert (not included)
SER16	€ 47,50	16 x 16 mm	100 mm	16ER..
SER20	€ 61,00	20 x 20 mm	125 mm	16ER...
SER25	€ 70,50	25 x 25 mm	150 mm	16ER...

SNRx

INTERNAL THREAD TOOL HOLDER

FOR INDEXABLE CARBIDE INSERTS



Art.	€	ø	h	L	Insert (not included)
SNR12	€ 47,50	12 mm	11 mm	150 mm	11IR...
SNR16	€ 55,40	16 mm	15 mm	170 mm	16IR...
SNR20	€ 67,10	20 mm	18 mm	170 mm	16IR...
SNR25	€ 83,10	25 mm	23 mm	300 mm	16IR...

T088

€ 85,80

TOOL CUTTING SET

TOOL CUTTING SET FOR EXTERNAL



Set composition 1 Pc SGTBK16 - 1 Pc SGIH26/2 - 1 Pc SGIH26/3

T089

€ 60,10

TOOL CUTTING SET

FOR EXTERNAL



Set composition 1 Pc SGIH19/2 - 1 Pc SGTBK10

T09x

TOOL CUTTING SET

FOR EXTERNAL



Art.	€	Set composition
T090	€ 141,00	1 Pc SGIH32/3 - 1 Pc SGIH32/4 - 1 Pc SGIH32/5 - 1 Pc SGTBK25
T091	€ 103,00	1 Pc SGIH26/2 - 1 Pc SGIH26/3 - 1 Pc SGTBK20

SGIH

TOOL FOR EXTERNAL CUTTING - BLADE

FOR INDEXABLE CARBIDE INSERTS OF 2 mm



Art.	€	Overall sizes	Insert (not included)
SGIH19/2	€ 23,00	19,5 x 85 mm	GCMX2N134
SGIH26/2	€ 28,60	25,75h x 109 mm	GCMX2N134
SGIH26/3	€ 28,60	25,75h x 109 mm	GCMX3N134
SGIH32/3	€ 28,60	31,75h x 150 mm	GCMX3N134
SGIH32/4	€ 28,60	31,75h x 160 mm	GCMX4N134
SGIH32/5	€ 28,60	31,75h x 160 mm	GCMX5N134

SGTBK

TOOL FOR EXTERNAL CUTTING - BLADE TOOL HOLDER

26 mm, FOR MEDIUM LATHE



Art.	€	Shank	Dimensions	Blade
SGTBK10	€ 38,00	10 x 10 mm	56 x 25 x 30 mm	19 mm
SGTBK16	€ 41,20	16 x 16 mm	87 x 38 x 33 mm	26 mm
SGTBK20	€ 45,30	20 x 20 mm	100 x 38 x 45h mm	26 mm
SGTBK25	€ 56,60	25 x 25 mm	110 x 49 x 48h mm	32 mm

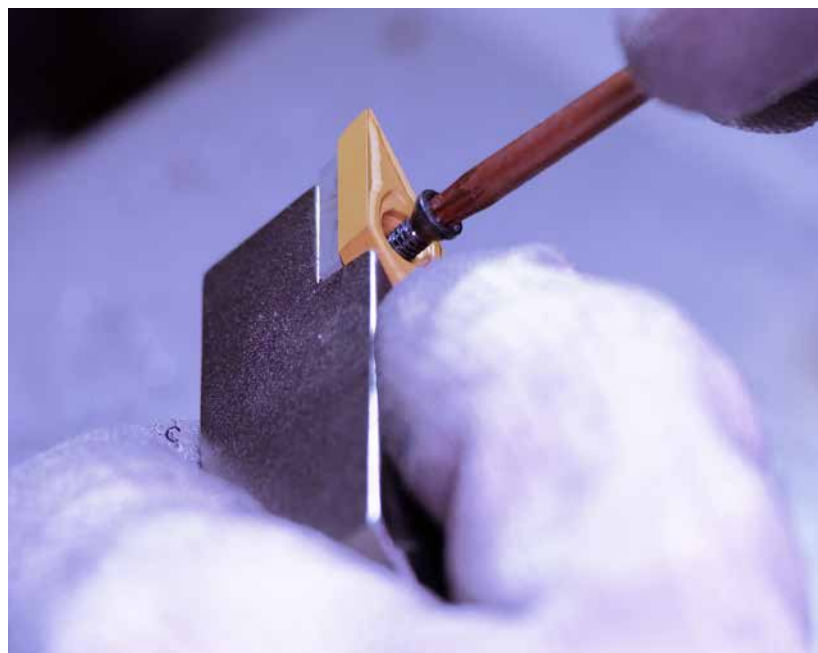

BSHG16 € 21,30
SET 5 BASES 16MM



BU3550 € 21,30
5 BUSHING SET



BSCL09 € 21,30
SET 5 BASES 9MM

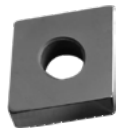

BSCL12 € 21,30
SET 5 BASES 12 mm



BU4560 € 21,30
5 BUSHING SET



BSSS12 € 21,30
5 SQUARE BASE 12MM



BSVJ16 € 21,30
SET 5 BASES 16 mm



BSDJ11 € 23,80
5 RHOMBIC BASES 11 mm

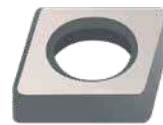

BU4050 € 23,40
5 BUSHING SET



RICAPCLN € 14,40
BASE BRACKET SCREW KIT



RICAPTGN € 13,30
BASE BRACKET SCREW KIT



RICAPSSN € 14,40
BASE BRACKET SCREW KIT



STAFCKJNR € 16,90
RIGHT TOOL BRACKET



STAFCKJNL € 16,90
LEFT TOOL BRACKET



BASECKJNR € 9,80
CARBIDE BASE RIGHT TOOL



BASECKJNL € 9,80
CARBIDE BASE LEFT TOOL



VITECKJN € 3,97
TOOL SCREW



PDJNRKIT € 16,50
KIT PARTS



PWLNKIT € 13,80
BASE BRACKET SCREW KIT



MCLNBASE25/32 € 16,70
BASE

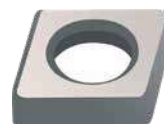

CTMTC16/20 € 20,60
TOOL BRACKET 16 - 20



CTMTC25/32 € 20,60
TOOL BRACKET 25 - 32



MTFNBASE25/32 € 13,00
BASE



CTFP10/12 € 20,60
TOOL BRACKET



CTFPBASE25/32

€ 13,00

BASE
FOR 25 - 32



BSER16

€ 28,20

5 CARBIDE BASE
16MM



BSNR16

€ 28,20

5 CARBIDES
16 mm



KVx

10 PC SCREWS SET

Art.	€	Screw
KV200	€ 17,70	T8 / M2
KV250	€ 17,70	T8 / M2,5
KV300	€ 17,70	T15 / M3
KV350	€ 17,70	T15 / M3,5

Art.	€	Screw
KV400	€ 17,70	T15 / M4
KV450	€ 17,70	T15 / M4,5
KV500	€ 17,70	T20 / M5



COMPATIBLE SCREWS SET

	KV200	KV250	KV350	KV400	KV450
STGCR16/11		•			
STGCL16/11		•			
STGCR20			•		
STGCL20			•		
STGCR25			•		
STGCL25			•		
SCLCR12E				•	
SCCL12E				•	
SCLCR16E				•	
SCCL16E				•	
SCLCR20E					•
SCCL20E					•
SCLCR25E					•
SCCL25E					•
SSSCR20E					•
SSSCL20E					•
SSSCR25E					•
SSSCL25E					•
SVJBR20			•		
SVJBL20			•		
SVJBR25			•		
SVJBL25			•		
SDJCR10		•			
SDJCR12		•			
SDJCR16		•			
SDJCR20			•		
SDJCL20			•		
SDJCR25			•		
SDJCL25			•		

	KV200	KV250	KV350	KV400	KV450
B001/12		•			
B001/18		•			
SSSCR16				•	
SSSCR20				•	
SSSCR25				•	
SCLCR08		•			
SCLCL08		•			
SCLCR10		•			
SCLCL10		•			
SCLCR12		•			
SCLCL12		•			
SCLCR16				•	
SCLCL16				•	
SCLCR20				•	
SCLCL20				•	
SCLCR25				•	
SCLCL25				•	
SCLCR32				•	
SCLCL32				•	
STFCR08		•			
STFCL08		•			
STFCR10		•			
STFCL10		•			
STFCR12		•			
STFCL12		•			
STFCR16			•		
STFCL16			•		
STFCR20			•		
STFCL20			•		

COMPATIBILITY CHART

	KV200	KV250	KV350	KV400	KV450
STFCLR25			•		
STFCL25			•		
STFCR32			•		
STFCL32			•		
SDUCR10					
SDUCL10		•			
SDUCR12		•			
SDUCL12		•			
SDUCR16		•			
SDUCL16		•			
SDUCR20			•		
SDUCL20			•		
SDUCR25			•		
SDUCL25			•		
SDUCR32			•		
SDUCL32			•		
SER16			•		
SER20			•		
SER25			•		
SNR12		•			
SNR16			•		
SNR20			•		
SNR25			•		
KITCKJ20					
KITCKJ25					
B007/10	•				
B007/12		•			
B007/16			•		

COMPATIBLE BASES AND BUSHINGS SETS

	BSTG16	BU0350	BSCL09	BSCL12	BU04560	BSS512	BSVJ16	BU0350	BSCL09	BSCL12	BU04560	BSS512	BSVJ16
STGCR16/11													
STGCL16/11													
STGCR20	•	•					•						
STGCL20	•	•					•						
STGCR25	•	•					•						
STGCL25	•	•					•						
SCLCR16E			•	•	•			•	•	•			
SCCL16E			•	•	•			•	•	•			
SCLCR20E			•	•	•			•	•	•			
SCCL20E			•	•	•			•	•	•			
SCLCR25E			•	•	•			•	•	•			
SCCL25E			•	•	•			•	•	•			
SSSCR20E			•	•	•			•	•	•			
SSSCL20E			•	•	•			•	•	•			

	BSTG16	BU0350	BSCL09	BSCL12	BU04560	BSS512	BSVJ16	BU0350	BSCL09	BSCL12	BU04560	BSS512	BSVJ16
SSSCR25E						•	•					•	•
SSSCL25E						•	•					•	•
SVJBR20		•						•					•
SVJBL20		•						•					•
SVJBR25		•						•					•
SVJBL25		•						•					•
SDJCR20									•				
SDJCL20										•			
SDJCR25											•		
SDJCL25												•	
SER20		•											
SER25		•											
SNR20		•											
SNR25		•											

COMPATIBLE TOOLS

ART.	€	SGTBK10	SGTBK16	SGTBK20	SGTBK25	T088	T089	T090	T091	PAG
SGIH19/2	29,00	•					•			219
SGIH26/2	36,10		•	•		•			•	219
SGIH26/3	36,10		•	•		•			•	219
SGIH32/3	36,10				•			•		219
SGIH32/4	36,10				•			•		219
SGIH32/5	36,10				•			•		219

F300-

STRAIGHT SHANK FACE MILLING CUTTER

90°

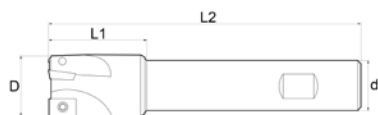

Art.	€	D	d	Z	L1	L2	Screw	Insert (not included)
F300/12	€ 32,50	12 mm	12 mm	1	27 mm	120 mm	T8/25 KV250	APKT1003PDER20A
F300/14	€ 32,50	14 mm	12 mm	1	27 mm	120 mm	T8/25 KV250	APKT1003PDER20A
F300/16	€ 38,70	16 mm	16 mm	2	27 mm	120 mm	T8/25 KV250	APKT1003PDER20A
F300/18	€ 43,10	18 mm	16 mm	2	27 mm	120 mm	T8/25 KV250	APKT1003PDER20A
F300/20	€ 46,20	20 mm	20 mm	3	32 mm	120 mm	T8/25 KV250	APKT1003PDER20A
F300/22	€ 46,20	22 mm	20 mm	3	27 mm	120 mm	T8/25 KV250	APKT1003PDER20A
F300/25	€ 55,30	25 mm	20 mm	4	27 mm	120 mm	T8/25 KV250	APKT1003PDER20A
F300/25/16	€ 55,30	25 mm	20 mm	2	44 mm	120 mm	T15/40 KV400	APKT1604PDER20A
F300/25/16L	€ 64,30	25 mm	20 mm	2	44 mm	200 mm	T15/40 KV400	APKT1604PDER20A
F300/32/16	€ 64,30	32 mm	25 mm	3	50 mm	120 mm	T15/40 KV400	APKT1604PDER20A
F300/32/16L	€ 89,50	32 mm	32 mm	3	55 mm	200 mm	T15/40 KV400	APKT1604PDER20A

F301-

STRAIGHT SHANK FACE MILLING CUTTER

90°

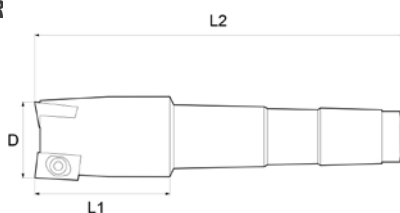

Art.	€	D	MT	Z	L1	L2	Screw	Insert (not included)
F301/25	€ 57,30	25 mm	3	2	40 mm	125 mm	T15/40 KV400	APKT1604PDER20A
F301/32	€ 61,20	32 mm	3	3	40 mm	125 mm	T15/40 KV400	APKT1604PDER20A
F301/40	€ 78,10	40 mm	3	4	35 mm	125 mm	T15/40 KV400	APKT1604PDER20A
F301/32CM4	€ 78,10	32 mm	4	3	45 mm	150 mm	T15/40 KV400	APKT1604PDER20A
F301/40CM4	€ 83,10	40 mm	4	4	40 mm	150 mm	T15/40 KV400	APKT1604PDER20A

F306-

FACE MILLING CUTTER

90° CENTER CUTTING



Art.	€	D	d	Z	L1	L2	Screw	Insert (not included)
F306/20	€ 71,30	20 mm	20 mm	2	18 mm	90 mm	T8/25 KV250	APKT1003PDER20A
F306/25	€ 87,10	25 mm	25 mm	2	18 mm	100 mm	T8/25 KV250	APKT1003PDER20A

F302-

FACE MILLING CUTTER

90°

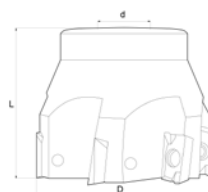

Art.	€	D	L	d	Z	Screw	Insert (not included)
F302/040	€ 126,00	40 mm	40 mm	16 mm	4	KV400	APKT1604PDER20A
F302/050	€ 130,00	50 mm	50 mm	22 mm	4	KV400	APKT1604PDER20A
F302/063	€ 137,00	63 mm	50 mm	22 mm	6	KV400	APKT1604PDER20A
F302/080	€ 162,00	80 mm	50 mm	27 mm	7	KV400	APKT1604PDER20A
F302/100	€ 201,00	100 mm	50 mm	32 mm	8	KV400	APKT1604PDER20A

F304-

FACE MILLING CUTTER FOR BLIND SIDE'S INSERT

APKT1003PDER20A

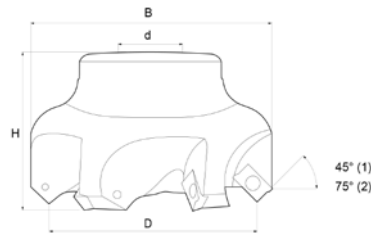

Art.	€	D	h	b	d	Z	Screw	Insert (not included)
F304/063	€ 232,00	63 mm	42 mm	71,2 mm	22 mm	6	T8/25 KV250	APKT1003PDER20A
F304/080	€ 188,00	80 mm	47 mm	84 mm	27 mm	5	T15/40 KV400	APKT1604PDER20A

F402-

FACE MILLING CUTTER

90°

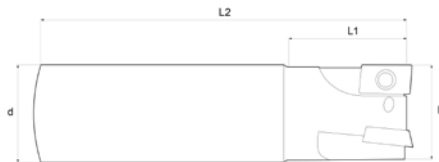

Art.	€	D	d	Z	L1	L2	Screw	Insert (not included)
F402/25	€ 46,60	25 mm	20 mm	2	35 mm	110 mm	T15/40 KV400	ADLT1503ZZR234
F402/32	€ 58,70	32 mm	25 mm	3	35 mm	120 mm	T15/40 KV400	ADLT1503ZZR234
F402/25L	€ 63,50	25 mm	25 mm	2	35 mm	200 mm	T15/40 KV400	ADLT1503ZZR234
F402/32L	€ 81,50	32 mm	25 mm	3	35 mm	200 mm	T15/40 KV400	ADLT1503ZZR234

F401-

FACE MILLING CUTTER

90°

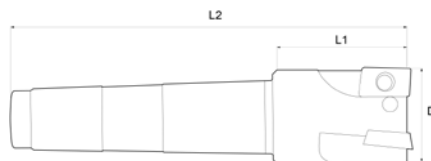

Art.	€	D	MT	Z	L1	L2	Screw	Insert (not included)
F401/25	€ 56,30	25 mm	3	2	44 mm	130 mm	T15/40 KV400	ADLT1503ZZR234
F401/32	€ 68,80	32 mm	3	3	44 mm	130 mm	T15/40 KV400	ADLT1503ZZR234
F401/40	€ 75,40	40 mm	3	4	44 mm	130 mm	T15/40 KV400	ADLT1503ZZR234
F401/40CM4	€ 88,40	40 mm	4	4	44 mm	153 mm	T15/40 KV400	ADLT1503ZZR234

F400-

FACE MILLING CUTTER

90°

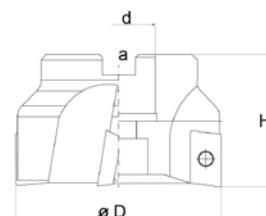

Art.	€	D	H	a	d	Z	Screw	Insert (not included)
F400/040	€ 80,80	40 mm	40 mm	8,4 mm	16 mm	4	T15/40 KV400	ADLT1503ZZR234
F400/050	€ 108,00	50 mm	40 mm	10,4 mm	22 mm	5	T15/40 KV400	ADLT1503ZZR234
F400/063	€ 124,00	63 mm	40 mm	10,4 mm	22 mm	6	T15/40 KV400	ADLT1503ZZR234
F400/080	€ 159,00	80 mm	50 mm	12,4 mm	27 mm	7	T15/40 KV400	ADLT1503ZZR234
F400/100	€ 195,00	100 mm	50 mm	14,4 mm	32 mm	8	T15/40 KV400	ADLT1503ZZR234

F256-

FACE MILLING

90°

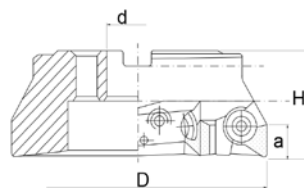

Art.	€	D	H	a	d	Z	Insert (not included)
F256/040	€ 127,00	40 mm	44 mm	16 mm	16 mm	3	TPKN1603R25
F256/050	€ 131,00	50 mm	44 mm	16 mm	22 mm	3	TPKN1603R25
F256/063	€ 142,00	63 mm	44 mm	16 mm	22 mm	3	TPKN1603R25
F256/080	€ 146,00	80 mm	52 mm	22 mm	27 mm	4	TPKN2204R25
F256/100	€ 188,00	100 mm	52 mm	22 mm	32 mm	5	TPKN2204R25

F407-

CAT. 42

MILLING CUTTER WITH NEGATIVE INSERTS FOR FACE MILLING

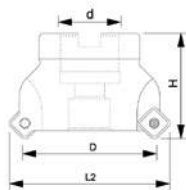

SNMX1205

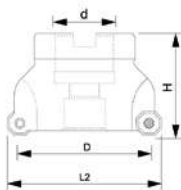

ONMX0505



Art.	€	D	H	L2	d	Z	Screw	Insert (not included)
F407/050	€ 107,00	50 mm	40 mm	63 mm	22 mm	4	SVT005	ONMX120520A - SNMX120520A
F407/063	€ 142,00	63 mm	40 mm	75 mm	22 mm	6	SVT005	ONMX120520A - SNMX120520A
F407/080	€ 177,00	80 mm	50 mm	93 mm	27 mm	7	SVT005	ONMX120520A - SNMX120520A
F407/100	€ 213,00	100 mm	50 mm	113 mm	32 mm	8	SVT005	ONMX120520A - SNMX120520A

F303-

FACE MILLING CUTTER

45°

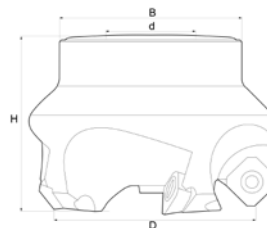

Art.	€	D	H	B	d	Z	Screw	Insert (not included)
F303/040	€ 100,00	40 mm	45 mm	53 mm	16 mm	3	T20/50 KV500	SEHX1204234 / SEHT1204AFN234
F303/050	€ 112,00	50 mm	48 mm	60 mm	22 mm	4	T20/50 KV500	SEHX1204234 / SEHT1204AFN234
F303/063	€ 131,00	63 mm	50 mm	76 mm	22 mm	5	T20/50 KV500	SEHX1204234 / SEHT1204AFN234
F303/080	€ 157,00	80 mm	50 mm	93 mm	27 mm	5	T20/50 KV500	SEHX1204234 / SEHT1204AFN234
F303/100	€ 185,00	100 mm	50 mm	113 mm	32 mm	6	T20/50 KV500	SEHX1204234 / SEHT1204AFN234
F303/125	€ 271,00	125 mm	60 mm	138 mm	40 mm	7	T20/50 KV500	SEHX1204234 / SEHT1204AFN234

F308-

FACE MILLING CUTTER

43°

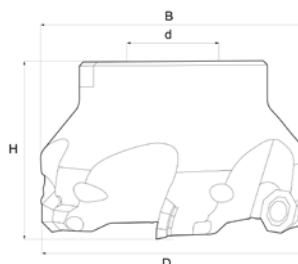

Art.	€	D	H	L2	d	Z	Screw	Insert (not included)
F308/063	€ 186,00	63 mm	40 mm	68 mm	22 mm	5	T15/40 KV400	OFEX05T305234
F308/080	€ 240,00	80 mm	50 mm	86 mm	27 mm	6	T15/40 KV400	OFEX05T305234
F308/100	€ 306,00	100 mm	50 mm	106 mm	32 mm	7	T15/40 KV400	OFEX05T305234

F406-

FACE MILLING CUTTER

45°

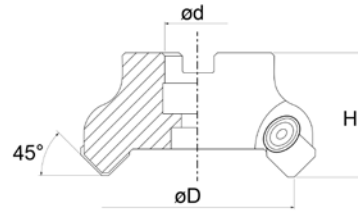

Art.	€	D	H	a	d	Z	Screw	Insert (not included)
F406/40	€ 127,00	40 mm	45 mm	8,4 mm	16 mm	3	T15/40 KV400	SEKN1203AFN25
F406/50	€ 133,00	50 mm	45 mm	10,4 mm	22 mm	4	T15/40 KV400	SEKN1203AFN25
F406/63	€ 142,00	63 mm	45 mm	12,4 mm	22 mm	5	T15/40 KV400	SEKN1203AFN25
F406/80	€ 164,00	80 mm	50 mm	14,4 mm	27 mm	5	T15/40 KV400	SEKN1203AFN25
F406/100	€ 211,00	100 mm	50 mm	16,4 mm	32 mm	6	T15/40 KV400	SEKN1203AFN25

F307/16/22

€ 127,00

INSERTS COUNTER SINKS SET

45°

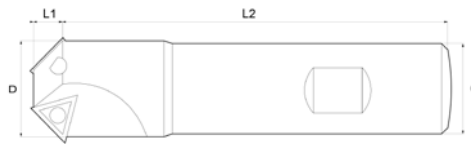

D	16 / 22 mm	Z	1 / 2
d	12 / 20 mm	Screw	T8/25 KV250
L1	7 mm	Insert (not included)	TCMT110204N
L2	90 / 100 mm		

F405-

COPING END MILL



Art.	€	D	d	H	L	Z	Screw	Insert (not included)
F405/25	€ 58,70	25 mm	25 mm	55 mm	200 mm	2	T15/40 KV400	RDHT10T3MO-N
F405/32	€ 81,50	32 mm	32 mm	55 mm	200 mm	3	T15/40 KV400	RDHT10T3MO-N

F404-

COPING END MILL

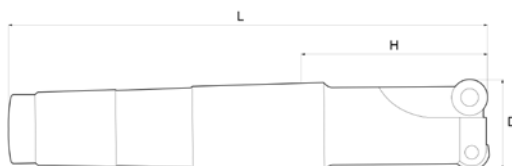



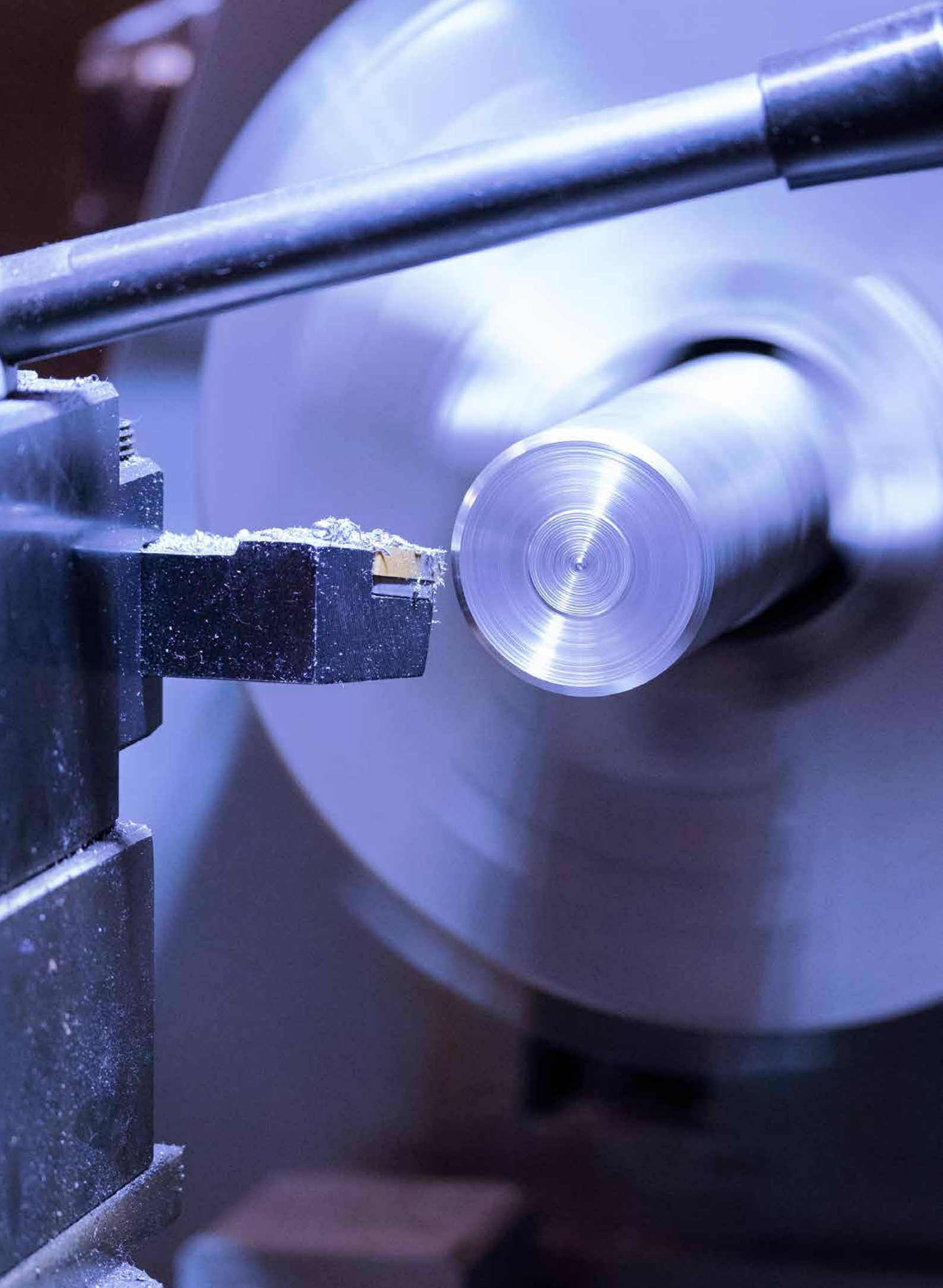

Art.	€	D	MT	H	L	Z	Screw	Insert (not included)
F404/25	€ 48,10	25 mm	3	44 mm	130 mm	2	T15/40 KV400	RDHT10T3MO-N
F404/32	€ 60,70	32 mm	3	44 mm	130 mm	3	T15/40 KV400	RDHT10T3MO-N
F404/40	€ 71,00	40 mm	3	44 mm	130 mm	3	T15/40 KV400	RDHT10T3MO-N













**INSERTS, LATHE TOOLS
AND TOOL BITS**

- pag.195*  — Insert for lathe
- pag.201*  — Milling inserts
- pag.204*  — Tapping inserts
- pag.205*  — Lathe tools
- pag.206*  — Tool bits









**DRILLS AND
HOLE SAWS**

- pag.208*  — Metal twist drills
- pag.218*  — Hole saws
- pag.222*  — Hole cutters
- pag.226*  — Masonry drills
- pag.228*  — Diamond tools
- pag.231*  — Wood drill bits



**MILLING
TOOLS**

- pag.233*  — Machine reamers
- pag.234*  — Counterborers
- pag.235*  — Disc shaper cutters
- pag.236*  — End mills
- pag.237*  — Stepped cutters & Countersinks
- pag.239*  — End mills for wood







**TAPS
AND DIES**

- pag.240*  — Tap and die sets
- pag.242*  — HSS taps
- pag.244*  — Dies



**THREAD
REPAIR**

- pag.245*  — Thread repair set
- pag.252*  — Thread repair tools
- pag.254*  — Taps for thread repair
- pag.257*  — Thread repair insert



**BANDSAW BLADES
AND SAW BLADES**



- pag.258*  — Bandsaw blades
- pag.258*  — Saw blades



BANDSAW BLADES



MATERIALS ISO CLASS	DESCRIPTION
P	STEEL
M	STAINLESS STEEL
K	CAST IRON
H	HARDENED MATERIALS
S	SUPER-ALLOYS AND TITANIUM

READING GUIDE

-  APPLICATIONS
-  MILLING
-  TURNING

-  ISO CLASS | EXAMPLE: P(K)
 EXCELLENT (SUITABLE)
-  GRADE

INSERTS GRADE

GRADE	MATERIALS ISO CLASS		DESCRIPTION
N	P15 P25 P30	M15 M25 M30	MT-CVD coated grade suitable for roughing and finishing of steel in dry and wet condition of use. The particular toughened substrate combined with the new high thickness overcoating makes this grade suitable in a large number of applications.
134	P20 P30 P45		MT-CVD coated grade ideal for roughing steel at interrupted shear. The particular toughened substrate combined with the new thick overcoating ensures high wear resistance and allows large volumes of chip removal.
234	P30 P45		MT-CVD coated grade suitable for roughing of steels. The toughness of the substrate and the high coating thickness guarantee high resistance in interrupted cutting condition and good resistance to blows. For use at medium low cutting speeds.
25	P10 P40		MT-CVD coated grade that combines good production capacity and toughness. Quality suitable for all types of work (both dry and wet) with particular effectiveness in face milling.
20A		M15 M25 M30	Grade coated with PVD technology suitable for machining of austenitic stainless steel. The unique combination of a homogeneous substrate and silicon coating makes this grade ideal for medium to high cutting speeds.

CCMTx

TURNING INSERTS

N P (KH) Finishing Positive

Art.	€	Dimension	d	l	s	r	a°
CCMT060204N	€ 6,20	06	6.35 mm	6.30 mm	2.38 mm	0.40 mm	7
CCMT09T304N	€ 7,20	09	9.52 mm	9.70 mm	3.97 mm	0.40 mm	7
CCMT09T308N	€ 7,20	09	9.52 mm	9.70 mm	3.97 mm	0.80 mm	7
CCMT120408N	€ 9,50	12	12.70 mm	12.90 mm	4.76 mm	0.80 mm	7

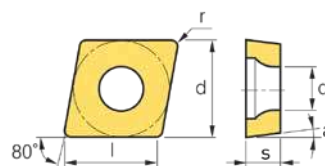

CCMTxA

CAT. 42

TURNING INSERTS

20A P (MK) Finishing Positive

Art.	€	Dimension	d	l	s	r	a°
CCMT06020420A	€ 6,50	06	6.35 mm	6.30 mm	2.38 mm	0.40 mm	7
CCMT09T30420A	€ 7,60	09	9.52 mm	9.70 mm	3.97 mm	0.40 mm	7
CCMT09T30820A	€ 7,60	09	9.52 mm	9.70 mm	3.97 mm	0.80 mm	7
CCMT12040820A	€ 10,00	12	12.70 mm	12.90 mm	4.76 mm	0.80 mm	7

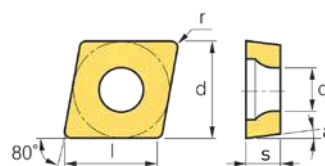

CNMGx

TURNING INSERTS

N P (KH) Finishing, medium Negative

Art.	€	Dimensions	d	l	s	r	a°
CNMG120404N	€ 8,00	12	12.70 mm	12.90 mm	4.76 mm	0.40 mm	-
CNMG120408N	€ 8,00	12	12.70 mm	12.90 mm	4.76 mm	0.80 mm	-

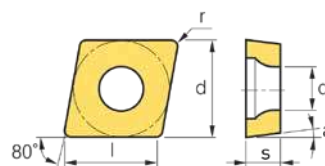

CNMGxF15

CAT. 42

TURNING INSERTS

F15 P (K) Finishing Negative

Art.	€	Dimensions	d	l	s	r	a°
CNMG120404F15	€ 8,40	12 mm	12.70 mm	12.90 mm	4.76	0.40	-

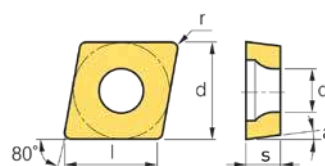

CNMGxF25

CAT. 42

TURNING INSERTS

F25 P (K) Finishing Negative

Art.	€	Dimensions	d	l	s	r	a°
CNMG120404F25	€ 8,40	12 mm	12.70 mm	12.90 mm	4.76	0.40	-

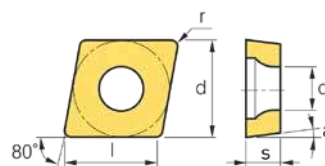

CNMGxM25

CAT. 42

TURNING INSERTS

M25 P (K) Medium Negative

Art.	€	Dimensions	d	l	s	r	a°
CNMG120408M25	€ 8,40	12 mm	12.70 mm	12.90 mm	4.76	0.80	-

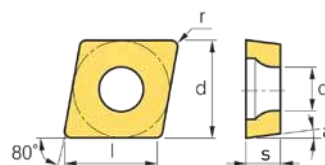

CNMGxM35

CAT. 42

TURNING INSERTS

M35 ISO P(K) Medium Negative

Art.	€	Dimensions	d	l	s	r	a°
CNMG120408M35	€ 8,40	12 mm	12.70 mm	12.90 mm	4.76	0.80	-

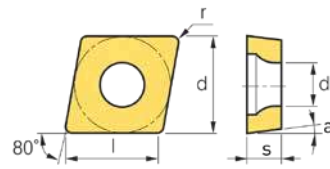

DCMTx

TURNING INSERTS

N ISO P(KH) Finitura Positive

Art.	€	Dimensions	d	l	s	r	a°
DCMT070204N	€ 6,20	07 mm	6.35 mm	7.70 mm	2.38	0.40	7
DCMT11T304N	€ 8,20	11 mm	9.52 mm	11.60 mm	3.97	0.40	7

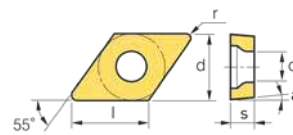

DCMTxA

CAT. 42

TURNING INSERTS

20A ISO PMS(KH) Finishing Positive

Art.	€	Dimensions	d	l	s	r	a°
DCMT07020420A	€ 6,50	07 mm	6.35 mm	7.70 mm	2.38	0.40	7
DCMT11T30420A	€ 8,60	11 mm	9.52 mm	11.60 mm	3.97	0.40	7

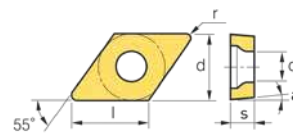

DNMGx

TURNING INSERTS

N ISO P(K) Medium Negative

Art.	€	Dimensions	d	l	s	r	a°
DNMG150608N	€ 12,00	15 mm	12.70 mm	15.50 mm	6.35	0.8	-

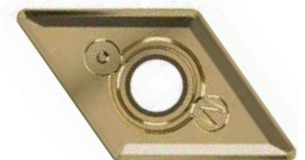
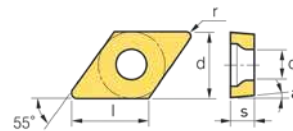

DNMGxM25

CAT. 42

TURNING INSERTS

M25 ISO P(K) Medium Negative

Art.	€	Dimensions	d	l	s	r	a°
DNMG150608M25	€ 12,70	15 mm	12.70 mm	15.50 mm	6.35	0.80	-

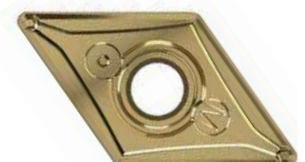
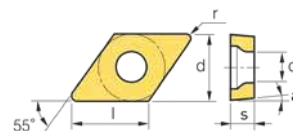

DNMGxM35

CAT. 42

TURNING INSERTS

M35 ISO P(K) Medium Negative

Art.	€	Dimensions	d	l	s	r	a°
DNMG150608M35	€ 12,70	15 mm	12.70 mm	15.50 mm	6.35	0.8	-

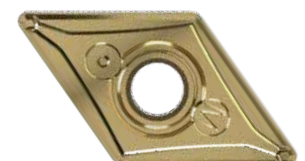
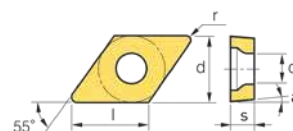

KNUX

TURNING INSERTS

N P Finishing Positive

Art.	€	Dimensions	d	l	s	r	a°
KNUX160405RN	€ 10,20	16 mm	9.52 mm	19.72 mm	4.76	0.50	-
KNUX160410RN	€ 10,20	16 mm	9.52 mm	19.72 mm	4.76	1.00	-
KNUX160405LN	€ 10,20	16 mm	9.52 mm	19.72 mm	4.76	0.50	-
KNUX160410LN	€ 10,20	16 mm	9.52 mm	19.72 mm	4.76	1.00	-

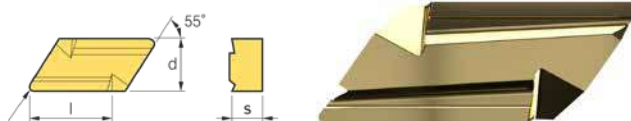

SCMTx

TURNING INSERTS

N PMS (KH) Finishing Positive

Art.	€	Overall sizes	d	l	s	r	a°
SCMT09T304N	€ 7,30	09 mm	9.52 mm	9.52 mm	3.97	0.40	7
SCMT09T308N	€ 7,30	09 mm	9.52 mm	9.52 mm	3.97	0.80	7
SCMT120408N	€ 10,10	12 mm	12.70 mm	12.70 mm	4.76	0.80	7

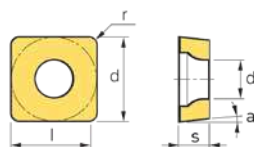

SCMTxA1

CAT. 42

TURNING INSERTS

20A P (KH) Finishing Positive

Art.	€	Overall sizes	d	l	s	r	a°
SCMT09T30420A	€ 7,70	09 mm	9.52 mm	9.52 mm	3.97	0.40	7

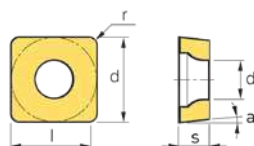

SCMTxA2

CAT. 42

TURNING INSERTS

20A PMS (KH) Finishing, medium Positive

Art.	€	Overall sizes	d	l	s	r	a°
SCMT09T30820A	€ 7,70	09 mm	9.52 mm	9.52 mm	3.97	0.80	7

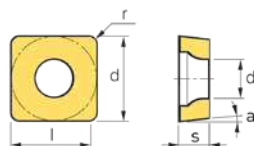

SCMTxA3

CAT. 42

TURNING INSERTS

20A PMS (KH) Finishing, medium Positive

Art.	€	Dimensions	d	l	s	r	a°
SCMT12040820A	€ 10,60	12 mm	12.70 mm	12.70 mm	4.76	0.80	7

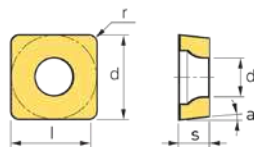

SNMGx

TURNING INSERTS

N P Finitura Negative

Art.	€	Overall sizes	d	l	s	r	a°
SNMG120404N	€ 8,90	12 mm	12.70 mm	12.70 mm	4.76	0.40	-
SNMG120408N	€ 8,90	12 mm	12.70 mm	12.70 mm	4.76	0.80	-

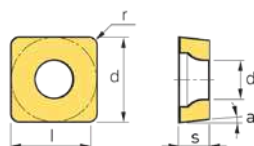

SNMGxF15

CAT. 42

TURNING INSERTS

F15 ISO P(K) Finishing Negative

Art.	€	Overall sizes	d	l	s	r	a°
SNMG120404F15	€ 9,40	12 mm	12.70 mm	12.70 mm	4.76	0.40	-

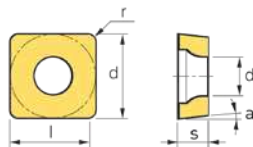

SNMGxF25

CAT. 42

TURNING INSERTS

F25 ISO P(K) Finishing Negative

Art.	€	Dimensions	d	l	s	r	a°
SNMG120404F25	€ 9,40	12 mm	12.70 mm	12.70 mm	4.76	0.40	-

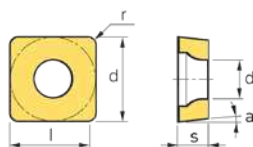

SNMGxM25

CAT. 42

TURNING INSERTS

F25 ISO P(K) Medium Negative

Art.	€	Dimensions	d	l	s	r	a°
SNMG120408M25	€ 9,40	12 mm	12.70 mm	12.70 mm	4.76	0.80	-

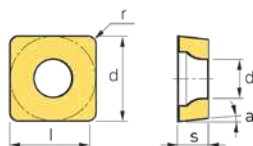

SNMGxM35

CAT. 42

TURNING INSERTS

M35 ISO P medium Negative

Art.	€	Dimensions	d	l	s	r	a°
SNMG120408M35	€ 9,40	12 mm	12.70 mm	12.70 mm	4.76	0.80	-

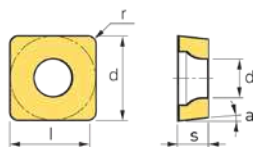

SPMRx

TURNING INSERTS

N ISO P Finishing Positive

Art.	€	Dimensions	d	l	s	r	a°
SPMR120304N	€ 8,30	12 mm	12.70 mm	12.70 mm	3.46	0.40	11
SPMR120308N	€ 8,30	12 mm	12.70 mm	12.70 mm	3.46	0.80	11

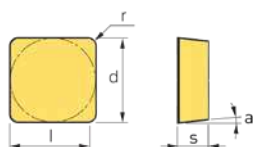

TCMTx

TURNING INSERTS

N ISO PMS(KH) Finishing, medium Positive

Art.	€	Dimensions	d	l	s	r	a°
TCMT090204N	€ 6,10	9 mm	3.4 mm	9.63 mm	2.5	0.4	7
TCMT110204N	€ 6,30	11 mm	6.35 mm	11.00 mm	2.38	0.40	7
TCMT16T304N	€ 8,10	16 mm	9.52 mm	16.50 mm	3.97	0.40	7
TCMT16T308N	€ 8,10	16 mm	9.52 mm	16.50 mm	3.97	0.80	7

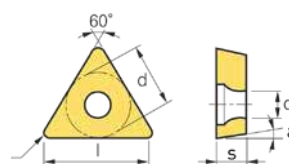

TCMTxA

CAT. 42

TURNING INSERTS

20A ISO P (M K) Finishing Positive

Art.	€	Dimensions	d	l	s	r	a°
TCMT09020420A	€ 6,40	9 mm	3.4 mm	9.63 mm	2.5	0.4	7
TCMT11020420A	€ 6,70	11 mm	6.35 mm	11.00 mm	2.38	0.40	7
TCMT16T30420A	€ 8,50	16 mm	9.52 mm	16.50 mm	3.97	0.40	7
TCMT16T30820A	€ 8,50	16 mm	9.52 mm	16.50 mm	3.97	0.80	7

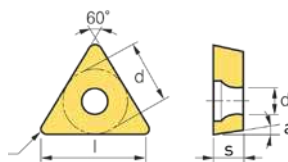

WNMGx

TURNING INSERTS

N ISO P medium Negative

Art.	€	Dimensions	d	l	s	r	a°
WNMG080408N	€ 10,10	08 mm	12.70 mm	8.70 mm	4.76	0.80	-

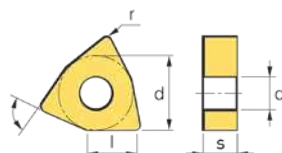

WNMGxM25

CAT. 42

TURNING INSERTS

M25 ISO P (K) medium Negative

Art.	€	Dimensions	d	l	s	r	a°
WNMG080408M25	€ 10,60	08 mm	12.70 mm	8.70 mm	4.76	0.80	-

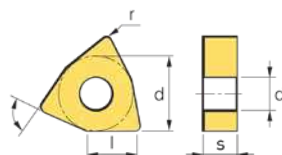

WNMGxM35

CAT. 42

TURNING INSERTS

M35 ISO P Medium Negative

Art.	€	Dimensions	d	l	s	r	a°
WNMG080408M35	€ 10,60	08 mm	12.70 mm	8.70 mm	4.76	0.80	-

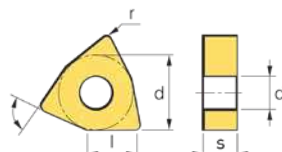

TNMGx

TURNING INSERTS

N ISO P (K) Finishing Negative

Art.	€	Dimensions	d	l	s	r	a°
TNMG160404N	€ 8,60	16 mm	9.52 mm	16.50 mm	4.76	0.40	-
TNMG160408N	€ 8,60	16 mm	9.52 mm	16.50 mm	4.76	0.80	-
TNMG220408N	€ 9,50	22 mm	12.7 mm	18.25 mm	4.81	0.5	-

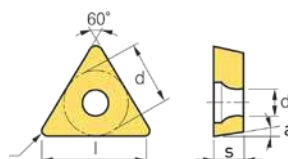

TNMGxF15

CAT. 42

TURNING INSERTS

F15 ISO P (K) Finishing Negative

Art.	€	Dimensions	d	l	s	r	a°
TNMG160404F15	€ 9,10	16 mm	9.52 mm	16.50 mm	4.76	0.40	-

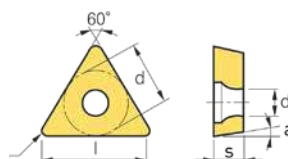

TNMGxF25

CAT. 42

TURNING INSERTS

F25 **P(K)** **Finishing** **Negative**

Art.	€	Overall sizes	d	l	s	r	a°
TNMG160404F25	€ 9,10	16 mm	9.52 mm	16.50 mm	4.76	0.40	-

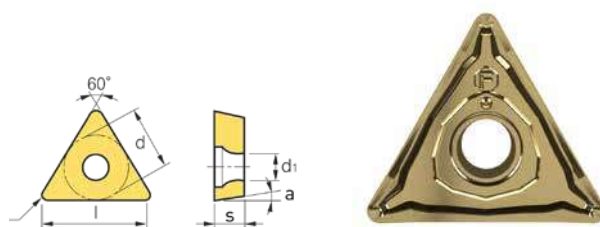

TNMGxM25

CAT. 42

TURNING INSERTS

M25 **P(K)** **Medium** **Negative**

Art.	€	Overall sizes	d	l	s	r	a°
TNMG160408M25	€ 9,10	16 mm	9.52 mm	16.50 mm	4.76	0.80	-

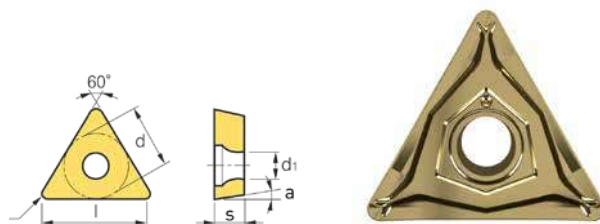

TNMGxM35

CAT. 42

TURNING INSERTS

M35 **P** **Medium** **Negative**

Art.	€	Overall sizes	d	l	s	r	a°
TNMG160408M35	€ 9,10	16 mm	9.52 mm	16.50 mm	4.76	0.80	-

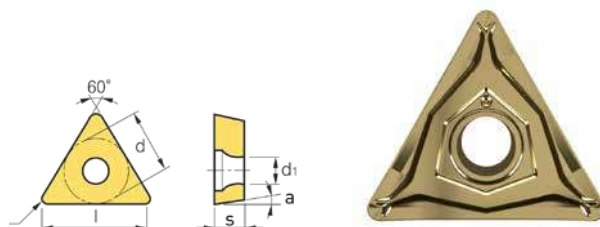

TPMRx

TURNING INSERTS

N **P** **Finishing** **Positive**

Art.	€	Dimension	d	l	s	r	a°
TPMR090204N	€ 4,91	9	5.98 mm	10.37 mm	3.44	0.40	7
TPMR110304N	€ 5,50	11	5.98 mm	10.37 mm	3.44	0.40	7
TPMR110308N	€ 5,50	11	5.98 mm	10.37 mm	3.44	0.80	7
TPMR160304N	€ 7,30	16	9.23 mm	16 mm	3.52	0.40	7
TPMR160308N	€ 7,30	16	9.23 mm	16 mm	3.52	0.80	7

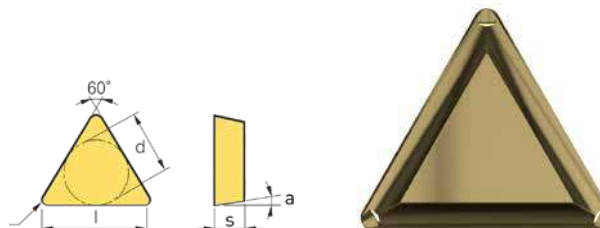

VBMTx

TURNING INSERTS

N **P** **Finishing** **Positive**

Art.	€	Overall sizes	d	l	s	r	a°
VBMT160404N	€ 11,60	16 mm	9.52 mm	16.60 mm	4.76	0.40	5

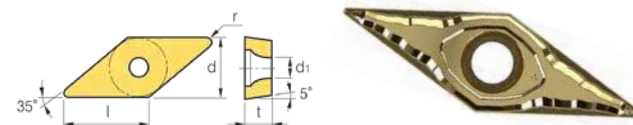

VBMTxA

CAT. 42

TURNING INSERTS

20A **PMS(KH)** **Finishing, medium** **Positive**

Art.	€	Dimensions	d	l	s	r	a°
VBMT16040420A	€ 12,30	16 mm	9.52 mm	16.60 mm	4.76	0.40	5

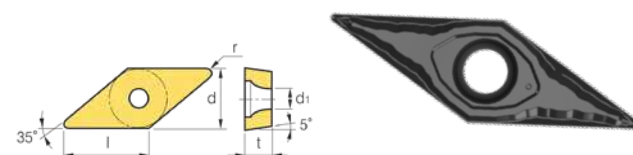

ADLTxA

MILLING INSERTS

20A ISO M(P) Medium, roughing $\leftarrow \uparrow 90^\circ$

Art.	€	Dimensions	d	l	s	r	a°
ADLT150308R20A	€ 8,90	15 mm	9.52 mm	14.5 mm	3.18	0.8	15

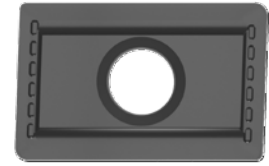
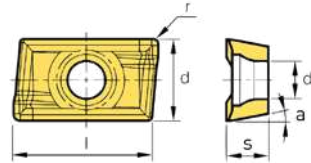

ADLTx

MILLING INSERTS

234 ISO P Medium, roughing $\leftarrow \uparrow 90^\circ$

Art.	€	Dimensions	d	l	s	r	a°
ADLT1503ZR234	€ 7,80	15 mm	9.52 mm	14.50 mm	3.18	0.80	15

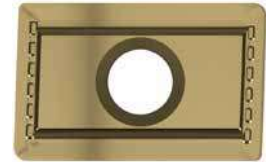
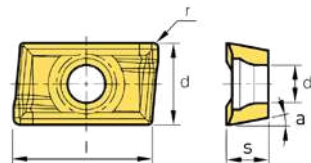

ADLTxA1

CAT. 42

MILLING INSERTS

20A ISO M(P) Medium, roughing $\leftarrow \uparrow 90^\circ$

Art.	€	Dimensions	d	l	s	r	a°
ADLT1503ZR20A	€ 8,30	15 mm	9.52 mm	14.50 mm	3.18	0.80	15

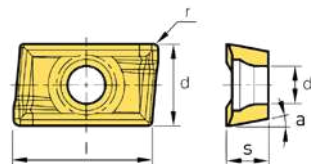

APKTx

MILLING INSERTS

20A ISO M(P SH) Medium $\leftarrow \uparrow 90^\circ$

Art.	€	Dimensions	d	l	s	r	a°
APKT1003PDER20A	€ 10,20	10 mm	6.70 mm	10.00 mm	3.49	0.50	11
APKT1604PDER20A	€ 11,60	16 mm	9.50 mm	16.30 mm	5.26	0.90	11

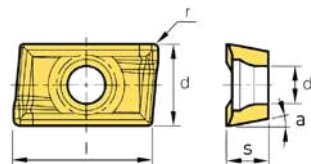

OFEXx

MILLING INSERTS

234 ISO P Finishing, medium $\leftarrow \uparrow 45^\circ$

Art.	€	Dimensions	d	l	s	r	a°
OFEX05T305234	€ 10,70	05 mm	12.80 mm	3.70 mm	4.00	0.50	25

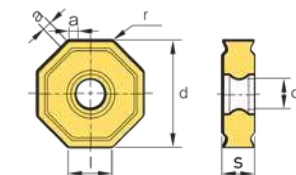

OFEXxA

CAT. 42

MILLING INSERTS

20A ISO M(P SH) Finishing, Medium $\leftarrow \uparrow 45^\circ$

Art.	€	Dimensions	d	l	s	r	a°
OFEX05T30520A	€ 11,30	05 mm	12.80 mm	3.70 mm	4.00	0.50	25

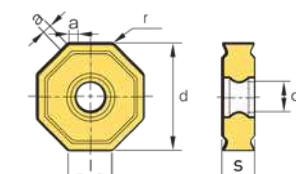

ONMXxA

CAT. 42

MILLING INSERTS

20A ISO M (P) Medium, finishing $\leftarrow 45^\circ$

Art.	€	Dimensions	d	l	s	r	a°
ONMX120520A	€ 13,80	05 mm	12.70 mm	1.50 mm	5.49	-	6

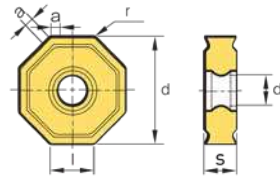

RDHTx

MILLING INSERTS

N ISO P (K) Medium, roughing

Art.	€	Dimensions	d	s	a°
RDHT10T3M0-N	€ 9,50	10 mm	10 mm	3.18	15

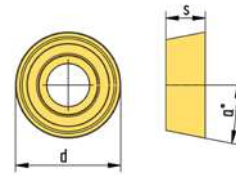

RPMTx

MILLING INSERTS

N ISO P (K) Medium, roughing

Art.	€	Dimensions	d	s	a°
RPMT1204N	€ 9,00	12 mm	12 mm	4.7	11

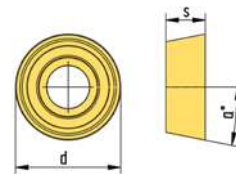

SEHTx

MILLING INSERTS

234 ISO P Finishing, medium $\leftarrow 45^\circ$

Art.	€	Dimensions	d	l	s	r	a°
SEHT1204AFN234	€ 14,00	12 mm	12.70 mm	- mm	4.76	1.00	20

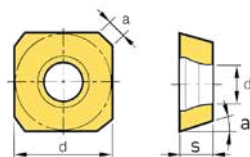

SEHTxA

CAT. 42

MILLING INSERTS

20A ISO M (P SH) Finishing, medium $\leftarrow 45^\circ$

Art.	€	Dimensions	d	l	s	r	a°
SEHT1204AFN20A	€ 14,80	12 mm	12.70 mm	- mm	4.76	1.00	20

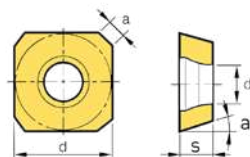

SEKNx

MILLING INSERTS

25 ISO P (K)

Art.	€	Dimensions	l	s	r	a°
SEKN1203AFN25	€ 8,10	12 mm	12.7 mm	3.17	2.25	20

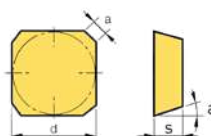

SEHXx

MILLING INSERTS

234 **ISO P** Medium, roughing $\leftarrow 45^\circ$

Art.	€	Dimensions	d	l	s	r	a°
SEHX1204234	€ 10,50	12 mm	12.70 mm	- mm	4.76	1.00	20

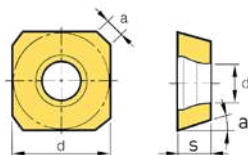

CAT. 42

SEHXxA

MILLING INSERTS

20A **ISO P (M)** Medium, roughing $\leftarrow 45^\circ$

Art.	€	Dimensions	d	l	s	r	a°
SEHX120420A	€ 11,10	12 mm	12.70 mm	- mm	4.76	1.00	20

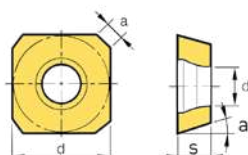

SNMXx

MILLING INSERTS

20A **ISO M (P)** Finishing, medium $\leftarrow 45^\circ$

Art.	€	Dimensions	d	l	s	r	a°
SNMX120520A	€ 10,80	12 mm	12.70 mm	- mm	5.49	0.40	0

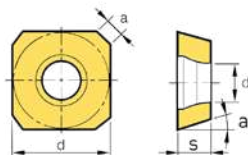

CAT. 42

SPKNx

MILLING INSERTS

25 **ISO P (K)**

Art.	€	Dimensions	l	s	r	a°
SPKN1203R25	€ 9,30	12 mm	12.7 mm	3.17	2.4	11

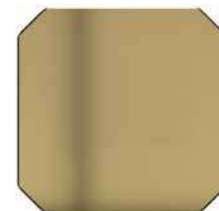
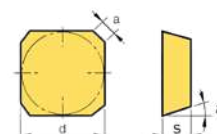

TPKNx

MILLING INSERTS

25 **ISO P (K)**

Art.	€	Dimensions	d	l	s	r	a°
TPKN1603R25	€ 7,30	22 mm	9.52 mm	16.5 mm	3.17	14	11
TPKN2204R25	€ 10,50	22 mm	9.52 mm	14.5 mm	3.18	0.8	15

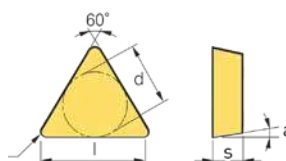

16IRx

INTERNAL THREAD INSERTS

28 ÷ 11 TPI 55°

Art.	€
11IRA55134	€ 9,50
11IRA60134	€ 9,50
16IR100ISO134	€ 10,70
16IR125ISO134	€ 10,70
16IR150ISO134	€ 10,70
16IR175ISO134	€ 10,70
16IR200ISO134	€ 10,70
16IR250ISO134	€ 10,70
16IR300ISO134	€ 10,70
16IRAG60134	€ 10,70
16IR14W134	€ 10,70
16IR11W134	€ 10,70
16IRAG55134	€ 10,70



16ERx

EXTERNAL THREAD INSERTS

28 ÷ 11 TPI 55°

Art.	€
16ER100ISO134	€ 10,70
16ER125ISO134	€ 10,70
16ER150ISO134	€ 10,70
16ER175ISO134	€ 10,70
16ER200ISO134	€ 10,70
16ER250ISO134	€ 10,70
16ER300ISO134	€ 10,70
16ERAG60134	€ 10,70
16ER14W134	€ 10,70
16ER11W134	€ 10,70
16ERAG55134	€ 10,70



GCMX

CUTTING INSERTS



ISO N ISO P

Art.	€
GCMX2N134	€ 7,60
GCMX3N134	€ 7,60
GCMX4N134	€ 8,60
GCMX5N134	€ 9,00



GCMXA

CUTTING INSERTS

CAT. 42

ISO 20A ISO M

Art.	€
GCMX2N20A	€ 8,00
GCMX3N20A	€ 8,00
GCMX4N20A	€ 9,10
GCMX5N20A	€ 9,50



165x

GROOVE INSERTS

Art.	€
165110134	€ 10,70
165130134	€ 10,70
165160134	€ 10,70
165185134	€ 10,70
165215134	€ 10,70
165265134	€ 10,70
165315134	€ 10,70



PRICES PER SINGLE ITEM, MINIMUM PACKAGING 10 * PIECES



B005-

CARBIDE TIPPED LATH E TOOL SET



5 Pcs HM - P25

Art.	€	Kit
B005	€ 22,00	1BRAS411108RP - 1BRAS411110RP - 1BRAS410312RP - 1BRAS-410412RP - 1BRAS410912RP
B005/16	€ 33,00	1BRAS411110RP - 1BRAS411112RP - 1BRAS410316RP - 1BRAS-410416RP - 1BRAS410916RP
B005/20	€ 41,30	1BRAS411112RP - 1BRAS411116RP - 1BRAS410320RP - 1BRAS-410420RP - 1BRAS410920RP

BRFix

CARBIDE TIPPED TOOL FOR INTERNAL THREAD

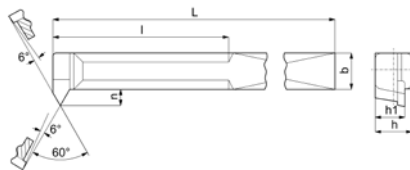

HM - P25 DIN 283

Art.	€	L	b	h
BRF10RP	€ 8,30	150 mm	10 mm	10 mm
BRF112RP	€ 9,00	180 mm	12 mm	12 mm
BRF116RP	€ 11,20	210 mm	16 mm	16 mm
BRF120RP	€ 11,60	250 mm	20 mm	20 mm
BRF125RP	€ 14,50	300 mm	25 mm	25 mm

BRCix

CARBIDE TIPPED TOOL FOR INTERNAL SLOTS

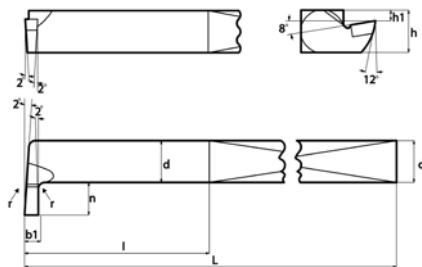

HM - P25 DIN 263

Art.	€	L	b	h	b1
BRC10RP	€ 8,60	150 mm	10 mm	10 mm	3 mm
BRC12RP	€ 8,60	180 mm	12 mm	12 mm	4 mm
BRC16RP	€ 9,80	210 mm	16 mm	16 mm	5 mm
BRC120RP	€ 10,70	250 mm	20 mm	20 mm	6 mm
BRC125RP	€ 13,80	300 mm	25 mm	25 mm	8 mm

BRFex

CARBIDE TIPPED TOOL FOR EXTERNAL THREAD

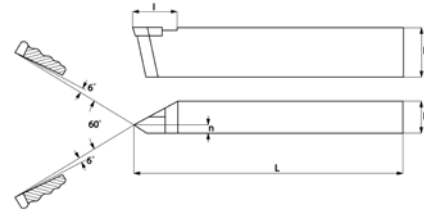

HM - P25 DIN 282

Art.	€	L	b	h
BRFE12RP	€ 7,90	100 mm	12 mm	12 mm
BRFE16RP	€ 9,00	100 mm	16 mm	16 mm
BRFE20RP	€ 11,20	125 mm	20 mm	20 mm
BRFE25RP	€ 13,50	140 mm	25 mm	25 mm

BRAS4111x

CARBIDE TIPPED TOOL FOR BLIND HOLES

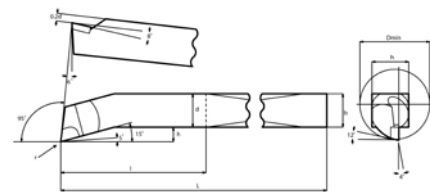

HM - P25 ISO 9 - DIN 4974

Art.	€	L	b	h
BRAS411108RP	€ 6,00	125 mm	8 mm	8 mm
BRAS411110RP	€ 7,30	150 mm	10 mm	10 mm
BRAS411112RP	€ 7,70	180 mm	12 mm	12 mm
BRAS411116RP	€ 9,30	210 mm	16 mm	16 mm
BRAS411120RP	€ 10,00	250 mm	20 mm	20 mm
BRAS411125RP	€ 15,00	300 mm	25 mm	25 mm
BRAS411132RP	€ 17,90	355 mm	32 mm	32 mm

BRAS4104x

CARBIDE TIPPED TOOL FOR FACING

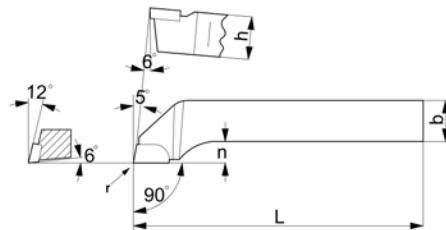

HM - P25 ISO 6 - DIN 4980

Art.	€	L	b	h
BRAS410410LP	€ 5,20	90 mm	10 mm	10 mm
BRAS410410RP	€ 5,20	90 mm	10 mm	10 mm
BRAS410412LP	€ 5,70	100 mm	12 mm	12 mm
BRAS410412RP	€ 5,70	100 mm	12 mm	12 mm
BRAS410416LP	€ 6,80	110 mm	16 mm	16 mm
BRAS410416RP	€ 6,80	110 mm	16 mm	16 mm
BRAS410420LP	€ 8,30	125 mm	20 mm	20 mm
BRAS410420RP	€ 8,30	125 mm	20 mm	20 mm
BRAS410425RP	€ 12,10	140 mm	25 mm	25 mm



BRAS4103x

CARBIDE TIPPED TOOL FOR OUTSIDE ROUGHING

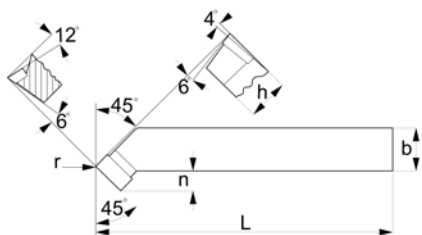

HM - P25 ISO 2 - DIN 4972

Art.	€	L	b	h
BRAS410310RP	€ 5,50	90 mm	10 mm	10 mm
BRAS410312LP	€ 6,00	100 mm	12 mm	12 mm
BRAS410312RP	€ 6,00	100 mm	12 mm	12 mm
BRAS410316LP	€ 7,20	110 mm	16 mm	16 mm
BRAS410316RP	€ 7,20	110 mm	16 mm	16 mm
BRAS410320LP	€ 8,80	125 mm	20 mm	20 mm
BRAS410320RP	€ 8,80	125 mm	20 mm	20 mm
BRAS410325RP	€ 12,70	140 mm	25 mm	25 mm

BRAS4109x

CARBIDE TIPPED TOOL FOR CUTTING OFF

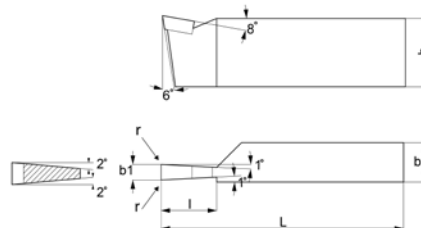

HM - P25 ISO 7 - DIN 4981

Art.	€	L	b	h	b1
BRAS410912RP	€ 5,50	100 mm	8 mm	12 mm	3 mm
BRAS410916RP	€ 6,00	110 mm	10 mm	16 mm	3,5 mm
BRAS410920RP	€ 6,70	125 mm	12 mm	20 mm	5 mm
BRAS410925RP	€ 9,40	140 mm	16 mm	25 mm	6 mm

B012-

HARDENED AND GROUNDED TOOL BITS



HSS - Co 8%

Art.	€	ø	Length	Tolerance
B012/04	€ 7,70	4 mm	200 mm	h9
B012/05	€ 8,60	5 mm	200 mm	h9
B012/06	€ 9,80	6 mm	200 mm	h9
B012/08	€ 12,70	8 mm	200 mm	h9
B012/10	€ 15,80	10 mm	200 mm	h9
B012/12	€ 20,00	12 mm	200 mm	h9
B012/13	€ 24,60	13 mm	135 mm	h9
B012/16	€ 37,70	16 mm	200 mm	h9
B012/20	€ 48,70	20 mm	200 mm	h9

B013-

HARDENED AND GROUNDED TOOL BITS



HSS - Co 8%

Art.	€	Sides dimension	Length	Tolerance
B013/04X04	€ 8,90	4 x 4 mm	200 mm	h13
B013/05X05	€ 11,30	5 x 5 mm	200 mm	h13
B013/06X06	€ 12,40	6 x 6 mm	200 mm	h13
B013/08X08	€ 15,00	8 x 8 mm	200 mm	h13
B013/10X10	€ 21,00	10 x 10 mm	200 mm	h13
B013/12X12	€ 24,70	12 x 12 mm	200 mm	h13
B013/14X14	€ 34,60	14 x 14 mm	200 mm	h13
B013/16X16	€ 39,70	16 x 16 mm	200 mm	h13
B013/20X20	€ 58,70	20 x 20 mm	200 mm	h13

B014-

HARDENED AND GROUNDED TOOL BITS



HSS - Co 8%

Art.	€	Sides dimension	Length	Tolerance
B014/20X04	€ 21,30	20 x 04 mm	200 mm	h13
B014/20X05	€ 22,90	20 x 05 mm	200 mm	h13
B014/20X06	€ 34,30	20 x 06 mm	200 mm	h13
B014/20X08	€ 43,50	20 x 08 mm	200 mm	h13
B014/20X10	€ 46,20	20 x 10 mm	200 mm	h13
B014/20X12	€ 46,20	20 x 12 mm	200 mm	h13
B014/25X06	€ 33,40	25 x 06 mm	200 mm	h13



ST1Ax

STRAIGHT SHANK TWIST DRILL

RIGHT HAND, SHORT LENGTH, BLACK FINISH, TO CUT MATERIALS WITH RESISTANCE R= 650 N/MM2, TWIST DRILL HARDNESS HV= 700 ÷ 740

PACKING OF 10* PIECES UNTIL Ø 8,00 MM, PACKING OF 5* PIECES FROM Ø 8,25 MM

HSS DIN 338/N 118°

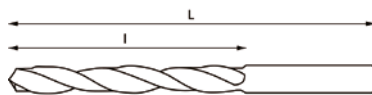

Art.	€	Ø	L	l
ST1A01	€ 0,37	1,00 mm	34 mm	12 mm
ST1A01.25	€ 0,37	1,25 mm	38 mm	16 mm
ST1A01.50	€ 0,37	1,50 mm	40 mm	18 mm
ST1A01.75	€ 0,37	1,75 mm	46 mm	22 mm
ST1A02	€ 0,37	2,00 mm	49 mm	24 mm
ST1A02.25	€ 0,37	2,25 mm	53 mm	27 mm
ST1A02.50	€ 0,37	2,50 mm	57 mm	30 mm
ST1A02.75	€ 0,37	2,75 mm	61 mm	33 mm
ST1A03	€ 0,37	3,00 mm	61 mm	33 mm
ST1A03.25	€ 0,40	3,25 mm	65 mm	36 mm
ST1A03.50	€ 0,40	3,50 mm	70 mm	39 mm
ST1A03.75	€ 0,40	3,75 mm	70 mm	39 mm
ST1A04	€ 0,40	4,00 mm	75 mm	43 mm
ST1A04.25	€ 0,47	4,25 mm	75 mm	43 mm
ST1A04.50	€ 0,47	4,50 mm	80 mm	47 mm
ST1A04.75	€ 0,47	4,75 mm	80 mm	47 mm
ST1A05	€ 0,53	5,00 mm	86 mm	52 mm

Art.	€	Ø	L	l
ST1A05.25	€ 0,53	5,25 mm	86 mm	52 mm
ST1A05.50	€ 0,53	5,50 mm	93 mm	57 mm
ST1A05.75	€ 0,61	5,75 mm	93 mm	57 mm
ST1A06	€ 0,61	6,00 mm	93 mm	57 mm
ST1A06.25	€ 0,69	6,25 mm	101 mm	63 mm
ST1A06.50	€ 0,69	6,50 mm	101 mm	63 mm
ST1A06.75	€ 0,92	6,75 mm	109 mm	69 mm
ST1A07	€ 0,92	7,00 mm	109 mm	69 mm
ST1A07.25	€ 0,92	7,25 mm	109 mm	69 mm
ST1A07.50	€ 1,00	7,50 mm	109 mm	69 mm
ST1A07.75	€ 1,07	7,75 mm	117 mm	75 mm
ST1A08	€ 1,07	8,00 mm	117 mm	75 mm
ST1A08.25	€ 1,23	8,25 mm	117 mm	75 mm
ST1A08.50	€ 1,23	8,50 mm	117 mm	75 mm
ST1A08.75	€ 1,37	8,75 mm	125 mm	81 mm
ST1A09	€ 1,37	9,00 mm	125 mm	81 mm
ST1A09.25	€ 1,52	9,25 mm	125 mm	81 mm

Art.	€	Ø	L	l
ST1A09.50	€ 1,52	9,50 mm	125 mm	81 mm
ST1A09.75	€ 1,60	9,75 mm	133 mm	87 mm
ST1A10	€ 1,68	10,00 mm	133 mm	87 mm
ST1A10.25	€ 1,99	10,25 mm	133 mm	87 mm
ST1A10.50	€ 1,99	10,50 mm	133 mm	87 mm
ST1A10.75	€ 2,28	10,75 mm	142 mm	94 mm
ST1A11	€ 2,28	11,00 mm	142 mm	94 mm
ST1A11.25	€ 2,59	11,25 mm	142 mm	94 mm
ST1A11.50	€ 2,59	11,50 mm	142 mm	94 mm
ST1A11.75	€ 2,89	11,75 mm	142 mm	94 mm
ST1A12	€ 2,89	12,00 mm	151 mm	101 mm
ST1A12.25	€ 3,28	12,25 mm	151 mm	101 mm
ST1A12.50	€ 3,28	12,50 mm	151 mm	101 mm
ST1A12.75	€ 3,28	12,75 mm	151 mm	101 mm
ST1A13	€ 3,28	13,00 mm	151 mm	101 mm

ST1AxR10

STRAIGHT SHANK TWIST DRILL

RIGHT HAND, SHORT LENGTH, BLACK FINISH, TO CUT MATERIALS WITH RESISTANCE R= 650 N/MM2, TWIST DRILL HARDNESS HV= 700 ÷ 740

PACKING OF 5* PIECES

HSS DIN 338/N 118°

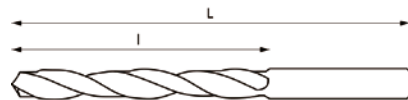

Art.	€	Ø	L	l
ST1A10.25R10	€ 2,13	10,25 mm	133 mm	87 mm
ST1A10.50R10	€ 2,13	10,5 mm	133 mm	87 mm
ST1A10.75R10	€ 2,41	10,75 mm	142 mm	94 mm
ST1A11.00R10	€ 2,41	11,00 mm	142 mm	94 mm
ST1A11.25R10	€ 2,76	11,25 mm	142 mm	94 mm
ST1A11.50R10	€ 2,76	11,5 mm	142 mm	94 mm
ST1A11.75R10	€ 3,12	11,75 mm	142 mm	94 mm
ST1A12.00R10	€ 3,12	12 mm	151 mm	101 mm

Art.	€	Ø	L	l
ST1A12.25R10	€ 3,47	12,25 mm	151 mm	101 mm
ST1A12.50R10	€ 3,47	12,50 mm	151 mm	101 mm
ST1A12.75R10	€ 3,47	12,75 mm	151 mm	101 mm
ST1A13.00R10	€ 3,47	13 mm	151 mm	101 mm
ST1A13.25R10	€ 4,39	13,25 mm	160 mm	108 mm
ST1A13.50R10	€ 4,39	13,5 mm	160 mm	108 mm
ST1A13.75R10	€ 4,39	13,75 mm	160 mm	108 mm
ST1A14.00R10	€ 4,39	14,00 mm	160 mm	108 mm

Art.	€	Ø	L	l
ST1A14.25R10	€ 4,82	14,25 mm	169 mm	114 mm
ST1A14.50R10	€ 4,82	14,5 mm	169 mm	114 mm
ST1A14.75R10	€ 4,82	14,75 mm	169 mm	114 mm
ST1A15.00R10	€ 4,82	15 mm	169 mm	114 mm
ST1A15.25R10	€ 5,90	15,25 mm	178 mm	120 mm
ST1A15.50R10	€ 5,90	15,50 mm	178 mm	120 mm
ST1A15.75R10	€ 5,90	15,75 mm	178 mm	120 mm
ST1A16.00R10	€ 5,90	16 mm	178 mm	120 mm

ST1AxR13

STRAIGHT SHANK TWIST DRILL

RIGHT HAND, SHORT LENGTH, BLACK FINISH, TO CUT MATERIALS WITH RESISTANCE R= 650 N/MM2, TWIST DRILL HARDNESS HV= 700 ÷ 740

PACKING OF 5* PIECES

HSS DIN 338/N 118°

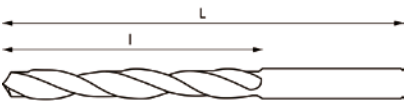

Art.	€	Ø	L	l
ST1A13.25R13	€ 4,39	13,25 mm	160 mm	108 mm
ST1A13.50R13	€ 4,39	13,50 mm	160 mm	108 mm
ST1A13.75R13	€ 4,39	13,75 mm	160 mm	108 mm
ST1A14.00R13	€ 4,39	14,00 mm	160 mm	108 mm

Art.	€	Ø	L	l
ST1A14.25R13	€ 4,82	14,25 mm	169 mm	114 mm
ST1A14.50R13	€ 4,82	14,50 mm	169 mm	114 mm
ST1A14.75R13	€ 4,82	14,75 mm	169 mm	114 mm
ST1A15.00R13	€ 4,82	15,00 mm	169 mm	114 mm

Art.	€	Ø	L	l
ST1A15.25R13	€ 5,90	15,25 mm	178 mm	120 mm
ST1A15.50R13	€ 5,90	15,50 mm	178 mm	120 mm
ST1A15.75R13	€ 5,90	15,75 mm	178 mm	120 mm
ST1A16.00R13	€ 5,90	16,00 mm	178 mm	120 mm

ST1AxC

STRAIGHT SHANK TWIST DRILL

RIGHT HAND, SHORT LENGTH, BLACK FINISH, TO CUT MATERIALS WITH RESISTANCE R= 650 N/MM2, TWIST DRILL HARDNESS HV= 700 ÷ 740

PACKING OF 10* PIECES

HSS DIN 1897/N 118°



Art.	€	ø	L	l
ST1A02.00C	€ 0,26	2,00 mm	38 mm	12 mm
ST1A02.50C	€ 0,26	2,50 mm	43 mm	14 mm
ST1A03.00C	€ 0,26	3,00 mm	46 mm	16 mm
ST1A03.25C	€ 0,30	3,25 mm	49 mm	18 mm

Art.	€	ø	L	l
ST1A03.50C	€ 0,30	3,50 mm	52 mm	20 mm
ST1A03.75C	€ 0,34	3,75 mm	52 mm	20 mm
ST1A04.00C	€ 0,34	4,00 mm	55 mm	22 mm
ST1A04.25C	€ 0,37	4,25 mm	55 mm	22 mm

Art.	€	ø	L	l
ST1A04.50C	€ 0,37	4,50 mm	58 mm	24 mm
ST1A05.00C	€ 0,44	5,00 mm	62 mm	26 mm
ST1A05.50C	€ 0,60	5,50 mm	66 mm	28 mm
ST1A06.00C	€ 0,60	6,00 mm	66 mm	28 mm

P046

€ 26,40

TWIST DRILL SET

RIGHT HAND, SHORT LENGTH, BLACK FINISH, TO CUT MATERIALS WITH RESISTANCE R= 650 N/MM2, TWIST DRILL HARDNESS HV= 700 ÷ 740



25 Pcs HSS DIN 338/N 118°

Size	1 ÷ 13 mm
Pieces	25

P045

€ 13,30

TWIST DRILL SET

RIGHT HAND, SHORT LENGTH, BLACK FINISH, TO CUT MATERIALS WITH RESISTANCE R= 650 N/MM2, TWIST DRILL HARDNESS HV= 700 ÷ 740



19 Pcs HSS DIN 338/N 118°

Size	1 ÷ 10 mm
Pieces	19

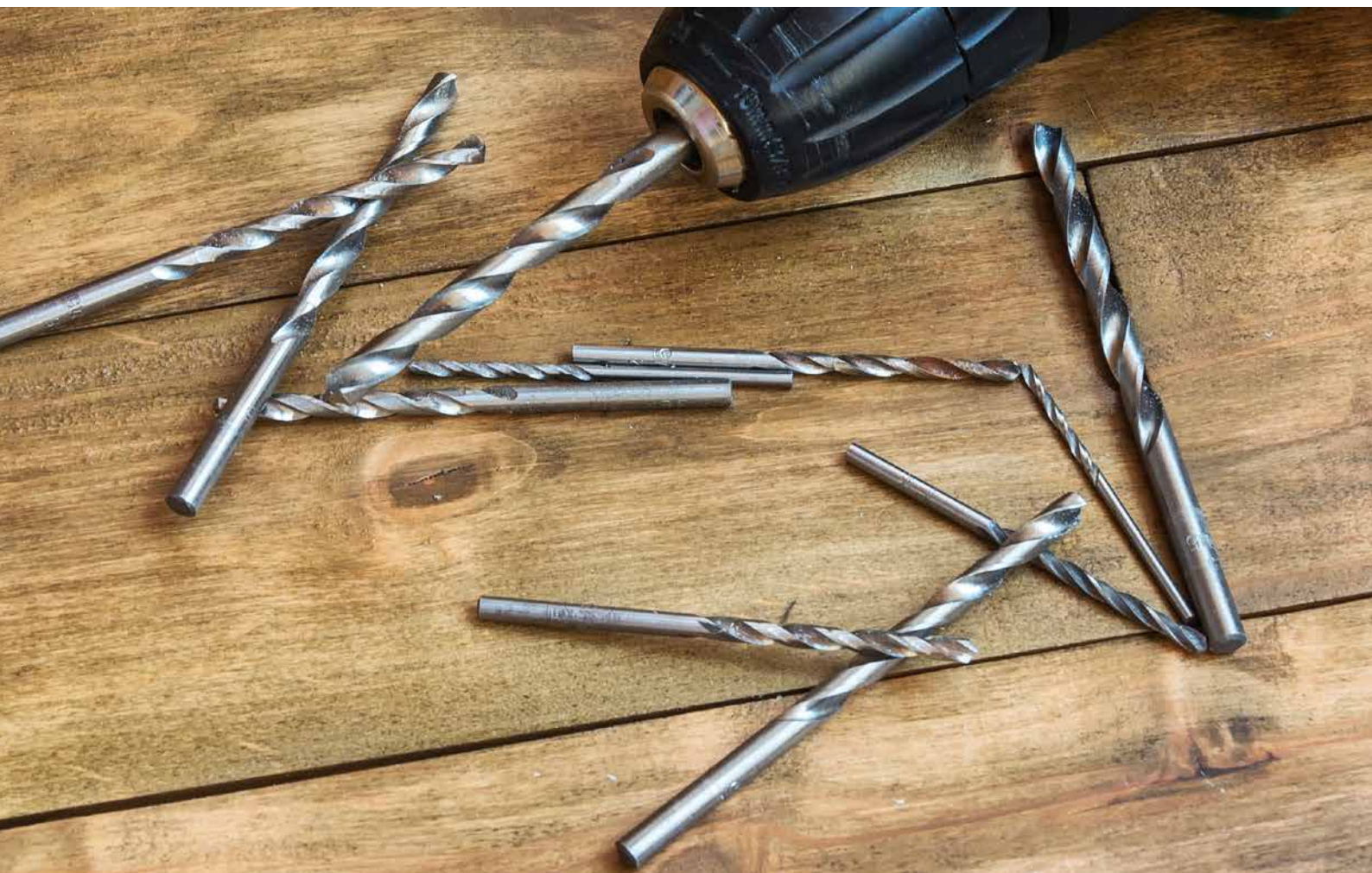

P058-

FULLY GROUND FROM THE SOLID TWIST DRILL

SPLIT POINT, TIN COATED

PACKING OF 10* PIECES UNTIL Ø 8,00 MM, PACKING OF 5* PIECES FROM Ø 8,25 MM



HSS TIN DIN 338 135°

Art.	€	ø	L	l
P058/01.00	€ 0,61	1 mm	34 mm	12 mm
P058/01.25	€ 0,61	1,25 mm	38 mm	16 mm
P058/01.50	€ 0,61	1,50 mm	40 mm	18 mm
P058/01.75	€ 0,61	1,75 mm	46 mm	22 mm
P058/02.00	€ 0,69	2 mm	49 mm	24 mm
P058/02.25	€ 0,76	2,25 mm	53 mm	27 mm
P058/02.50	€ 0,76	2,50 mm	57 mm	30 mm
P058/02.75	€ 0,76	2,75 mm	61 mm	33 mm
P058/03.00	€ 0,76	3 mm	61 mm	33 mm
P058/03.25	€ 0,92	3,25 mm	65 mm	36 mm
P058/03.50	€ 0,92	3,50 mm	70 mm	39 mm
P058/03.75	€ 0,92	3,75 mm	70 mm	39 mm
P058/04.00	€ 0,92	4 mm	75 mm	43 mm
P058/04.25	€ 1,23	4,25 mm	75 mm	43 mm
P058/04.50	€ 1,23	4,50 mm	80 mm	47 mm
P058/04.75	€ 1,23	4,75 mm	80 mm	47 mm
P058/05.00	€ 1,23	5 mm	86 mm	52 mm

Art.	€	ø	L	l
P058/05.25	€ 1,52	5,25 mm	86 mm	52 mm
P058/05.50	€ 1,52	5,50 mm	93 mm	57 mm
P058/05.75	€ 1,52	5,75 mm	93 mm	57 mm
P058/06.00	€ 1,52	6 mm	93 mm	57 mm
P058/06.25	€ 1,68	6,25 mm	101 mm	63 mm
P058/06.50	€ 1,68	6,50 mm	101 mm	63 mm
P058/06.75	€ 1,68	6,75 mm	109 mm	69 mm
P058/07.00	€ 1,68	7 mm	109 mm	69 mm
P058/07.25	€ 2,59	7,25 mm	109 mm	69 mm
P058/07.50	€ 2,59	7,50 mm	109 mm	69 mm
P058/07.75	€ 2,59	7,75 mm	117 mm	75 mm
P058/08.00	€ 2,59	8 mm	117 mm	75 mm
P058/08.25	€ 3,53	8,25 mm	117 mm	75 mm
P058/08.50	€ 3,53	8,50 mm	117 mm	75 mm
P058/08.75	€ 3,53	8,75 mm	125 mm	81 mm
P058/09.00	€ 3,53	9 mm	125 mm	81 mm
P058/09.25	€ 4,07	9,25 mm	125 mm	81 mm

Art.	€	ø	L	l
P058/09.50	€ 4,07	9,50 mm	125 mm	81 mm
P058/09.75	€ 4,07	9,75 mm	133 mm	87 mm
P058/10.00	€ 4,07	10 mm	133 mm	87 mm
P058/10.25	€ 4,60	10,25 mm	133 mm	87 mm
P058/10.50	€ 4,60	10,50 mm	133 mm	87 mm
P058/10.75	€ 4,60	10,75 mm	142 mm	94 mm
P058/11.00	€ 4,60	11 mm	142 mm	94 mm
P058/11.25	€ 5,40	11,25 mm	142 mm	94 mm
P058/11.50	€ 5,40	11,50 mm	142 mm	94 mm
P058/11.75	€ 5,40	11,75 mm	142 mm	94 mm
P058/12.00	€ 5,40	12 mm	151 mm	101 mm
P058/12.25	€ 6,70	12,25 mm	151 mm	101 mm
P058/12.50	€ 6,70	12,50 mm	151 mm	101 mm
P058/12.75	€ 6,70	12,75 mm	151 mm	101 mm
P058/13.00	€ 6,70	13 mm	151 mm	101 mm

P058/170

€ 149,00

FULLY GROUND FROM THE SOLID TWIST DRILL SET

SPLIT POINT, TIN COATED



170 Pcs HSS TIN DIN 338 135°

150 (10x) Pcs (step 0,5 mm) Ø 1 ÷ 8 mm
20 (5x) Pcs (step 0,5 mm) Ø 8,5 ÷ 10 mm

P010/51

€ 51,40

FULLY GROUND STRAIGHT SHANK TWIST DRILL SET

SPLIT POINT, TIN COATED



HSS TIN DIN 338 135°

Size (step 0,1 mm) 1 ÷ 6 mm
Pieces 51

P010/41

€ 120,00

FULLY GROUND STRAIGHT SHANK TWIST DRILL SET

SPLIT POINT, TIN COATED

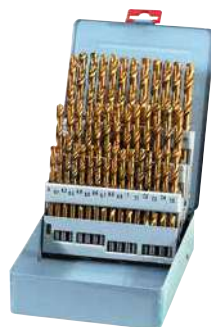

HSS TIN DIN 338 135°

Size (step 0,1 mm) 6 ÷ 10 mm
Pieces 41

P062

€ 56,60

STRAIGHT SHANK TWIST DRILL SET

SPLIT POINT, TIN COATED



25 Pcs HSS TIN DIN 338 135°

Size (step 0,5 mm) 1 ÷ 13 mm
Pieces 25

P061

€ 31,70

STRAIGHT SHANK TWIST DRILL SET

FULLY GROUND FROM THE SOLID SPLIT POINT, TIN COATED



19 Pcs HSS TiN DIN 338 135°

Size (step 0,5 mm)	1 ÷ 10 mm
Pieces	19

P068

€ 6,30

TWIST DRILL SET

FROM 0.25 TO 1 mm

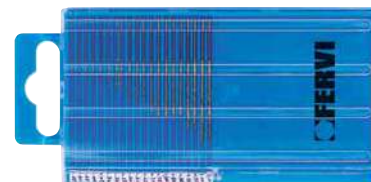

20 Pcs HSS TiN DIN 338 135° Plastic box

Sizes x 1 Pc	0.25 - 0.30 - 0.35 - 0.40 - 0.45 - 0.55 - 0.65 - 0.70 - 0.75 - 0.85 - 0.90 - 0.95 mm
Sizes x Pcs	0.50 - 0.60 - 0.80 - 1.00 mm

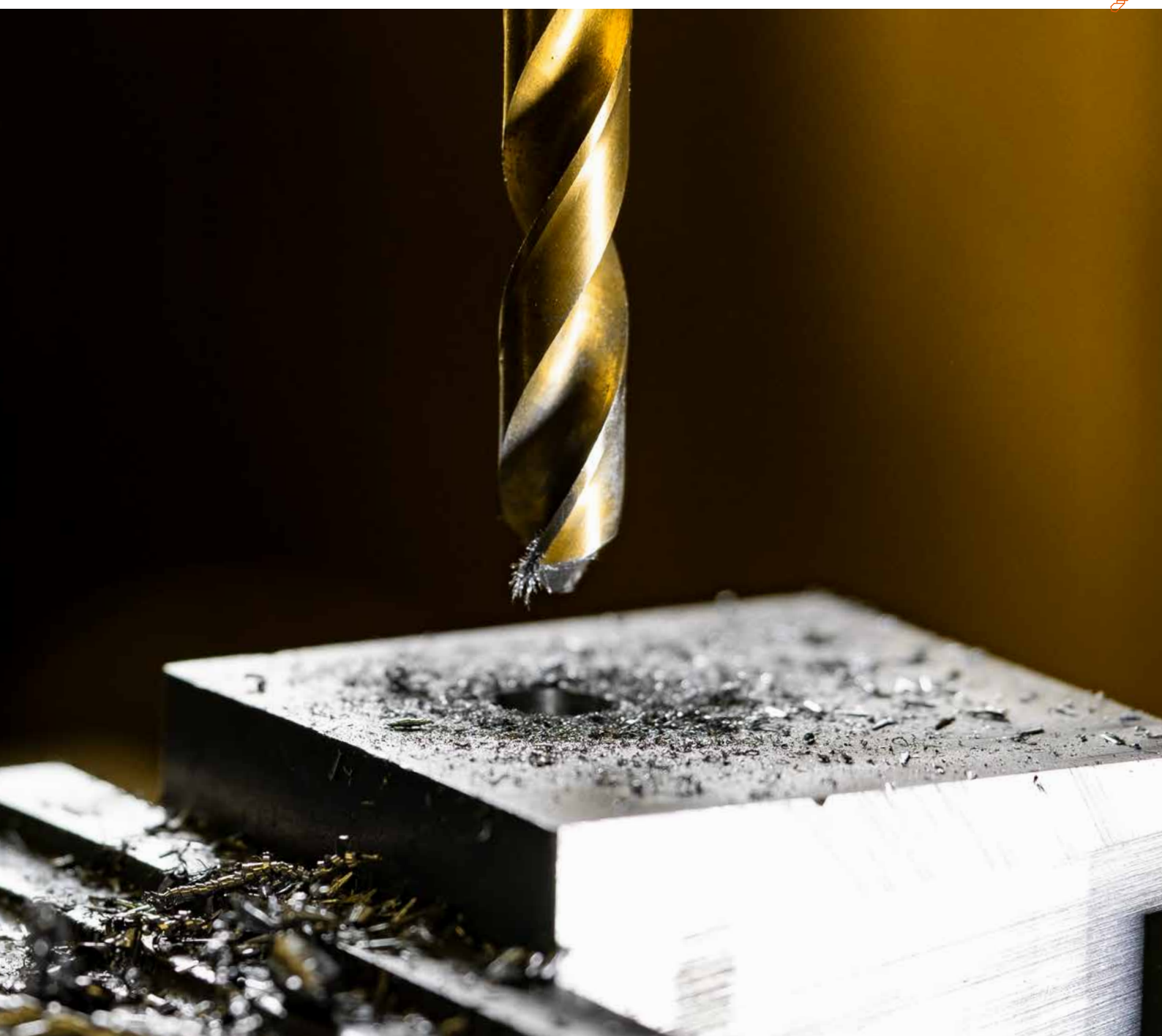

P023-

*CAT 42

STRAIGHT SHANK TWIST DRILL

FULLY GROUND, RIGHT HAND, SHORT LENGTH, TO CUT MATERIALS WITH RESISTANCE R= 800 N/MM2, TWIST DRILL HARDNESS HV= 770 ÷ 830

PACKING OF 10* PIECES UNTIL Ø 7,90 MM,
PACKING OF 5* PIECES FROM Ø 8,00 MM

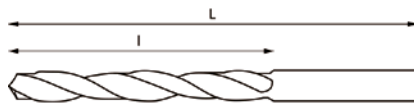

HSS DIN 338 135°

Art.	€	ø	L	l
P023/00.30	€ 0,33	0.30 mm	19 mm	3 mm
P023/00.35	€ 0,33	0.35 mm	19 mm	4 mm
P023/00.40	€ 0,33	0.40 mm	20 mm	5 mm
P023/00.45	€ 0,33	0.45 mm	20 mm	5 mm
P023/00.50	€ 0,33	0.50 mm	22 mm	6 mm
P023/00.55	€ 0,33	0.55 mm	24 mm	7 mm
P023/00.60	€ 0,33	0.60 mm	24 mm	7 mm
P023/00.65	€ 0,33	0.65 mm	26 mm	8 mm
P023/00.70	€ 0,33	0.70 mm	28 mm	9 mm
P023/00.75	€ 0,33	0.75 mm	28 mm	9 mm
P023/00.80	€ 0,33	0.80 mm	30 mm	10 mm
P023/00.85	€ 0,33	0.85 mm	30 mm	10 mm
P023/00.90	€ 0,33	0.90 mm	32 mm	11 mm
P023/00.95	€ 0,33	0.95 mm	32 mm	11 mm
P023/01.00	€ 0,75	1.00 mm	34 mm	12 mm
P023/01.10	€ 0,39	1.10 mm	36 mm	14 mm
P023/01.20	€ 0,39	1.20 mm	38 mm	16 mm
P023/01.25	€ 0,75	1.25 mm	38 mm	16 mm
P023/01.30	€ 0,39	1.30 mm	38 mm	16 mm
P023/01.40	€ 0,39	1.40 mm	40 mm	18 mm
P023/01.50	€ 0,68	1.50 mm	40 mm	18 mm
P023/01.60	€ 0,44	1.60 mm	43 mm	20 mm
P023/01.70	€ 0,44	1.70 mm	43 mm	20 mm
P023/01.75	€ 0,60	1.75 mm	46 mm	22 mm
P023/01.80	€ 0,44	1.80 mm	46 mm	22 mm
P023/01.90	€ 0,44	1.90 mm	46 mm	22 mm
P023/02.00	€ 0,60	2.00 mm	49 mm	24 mm
P023/02.10	€ 0,48	2.10 mm	49 mm	24 mm
P023/02.20	€ 0,48	2.20 mm	53 mm	27 mm
P023/02.25	€ 0,68	2.25 mm	53 mm	27 mm
P023/02.30	€ 0,48	2.30 mm	53 mm	27 mm
P023/02.40	€ 0,48	2.40 mm	57 mm	30 mm
P023/02.50	€ 0,60	2.50 mm	57 mm	30 mm
P023/02.60	€ 0,57	2.60 mm	57 mm	30 mm
P023/02.70	€ 0,57	2.70 mm	61 mm	33 mm
P023/02.75	€ 0,75	2.75 mm	61 mm	33 mm
P023/02.80	€ 0,57	2.80 mm	61 mm	33 mm
P023/02.90	€ 0,57	2.90 mm	61 mm	33 mm
P023/03.00	€ 0,68	3.00 mm	61 mm	33 mm
P023/03.10	€ 0,68	3.10 mm	65 mm	36 mm
P023/03.20	€ 0,68	3.20 mm	65 mm	36 mm
P023/03.25	€ 0,83	3.25 mm	65 mm	36 mm
P023/03.30	€ 0,75	3.30 mm	65 mm	36 mm
P023/03.40	€ 0,75	3.40 mm	70 mm	39 mm
P023/03.50	€ 0,75	3.50 mm	70 mm	39 mm
P023/03.60	€ 0,71	3.60 mm	70 mm	39 mm
P023/03.70	€ 0,71	3.70 mm	70 mm	39 mm
P023/03.75	€ 0,90	3.75 mm	70 mm	39 mm

Art.	€	ø	L	l
P023/03.80	€ 0,71	3.80 mm	75 mm	43 mm
P023/03.90	€ 0,71	3.90 mm	75 mm	43 mm
P023/04.00	€ 0,83	4.00 mm	75 mm	43 mm
P023/04.10	€ 0,79	4.10 mm	75 mm	43 mm
P023/04.20	€ 0,79	4.20 mm	75 mm	43 mm
P023/04.25	€ 1,13	4.25 mm	75 mm	43 mm
P023/04.30	€ 0,83	4.30 mm	80 mm	47 mm
P023/04.40	€ 0,83	4.40 mm	80 mm	47 mm
P023/04.50	€ 0,98	4.50 mm	80 mm	47 mm
P023/04.60	€ 0,97	4.60 mm	80 mm	47 mm
P023/04.70	€ 0,97	4.70 mm	80 mm	47 mm
P023/04.75	€ 1,13	4.75 mm	80 mm	47 mm
P023/04.80	€ 0,97	4.80 mm	86 mm	52 mm
P023/04.90	€ 0,97	4.90 mm	86 mm	52 mm
P023/05.00	€ 1,05	5.00 mm	86 mm	52 mm
P023/05.10	€ 1,21	5.10 mm	86 mm	52 mm
P023/05.20	€ 1,21	5.20 mm	86 mm	52 mm
P023/05.25	€ 1,43	5.25 mm	86 mm	52 mm
P023/05.30	€ 1,21	5.30 mm	86 mm	52 mm
P023/05.40	€ 1,21	5.40 mm	93 mm	57 mm
P023/05.50	€ 1,35	5.50 mm	93 mm	57 mm
P023/05.60	€ 1,27	5.60 mm	93 mm	57 mm
P023/05.70	€ 1,27	5.70 mm	93 mm	57 mm
P023/05.75	€ 1,58	5.75 mm	93 mm	57 mm
P023/05.80	€ 1,27	5.80 mm	93 mm	57 mm
P023/05.90	€ 1,27	5.90 mm	93 mm	57 mm
P023/06.00	€ 1,43	6.00 mm	93 mm	57 mm
P023/06.10	€ 1,31	6.10 mm	101 mm	63 mm
P023/06.20	€ 1,31	6.20 mm	101 mm	63 mm
P023/06.25	€ 2,03	6.25 mm	101 mm	63 mm
P023/06.30	€ 1,31	6.30 mm	101 mm	63 mm
P023/06.40	€ 1,31	6.40 mm	101 mm	63 mm
P023/06.50	€ 1,80	6.50 mm	101 mm	63 mm
P023/06.60	€ 1,59	6.60 mm	101 mm	63 mm
P023/06.70	€ 1,59	6.70 mm	101 mm	63 mm
P023/06.75	€ 2,33	6.75 mm	109 mm	69 mm
P023/06.80	€ 1,59	6.80 mm	109 mm	69 mm
P023/06.90	€ 1,59	6.90 mm	109 mm	69 mm
P023/07.00	€ 2,18	7.00 mm	109 mm	69 mm
P023/07.10	€ 1,82	7.10 mm	109 mm	69 mm
P023/07.20	€ 1,82	7.20 mm	109 mm	69 mm
P023/07.25	€ 2,55	7.25 mm	109 mm	69 mm
P023/07.30	€ 1,82	7.30 mm	109 mm	69 mm
P023/07.40	€ 1,82	7.40 mm	109 mm	69 mm
P023/07.50	€ 2,25	7.50 mm	109 mm	69 mm
P023/07.60	€ 2,04	7.60 mm	117 mm	75 mm
P023/07.70	€ 2,04	7.70 mm	117 mm	75 mm
P023/07.75	€ 2,85	7.75 mm	117 mm	75 mm

Art.	€	ø	L	l
P023/07.80	€ 2,04	7.80 mm	117 mm	75 mm
P023/07.90	€ 2,04	7.90 mm	117 mm	75 mm
P023/08.00	€ 2,70	8.00 mm	117 mm	75 mm
P023/08.10	€ 2,31	8.10 mm	117 mm	75 mm
P023/08.20	€ 2,31	8.20 mm	117 mm	75 mm
P023/08.25	€ 3,45	8.25 mm	117 mm	75 mm
P023/08.30	€ 2,31	8.30 mm	117 mm	75 mm
P023/08.40	€ 2,31	8.40 mm	117 mm	75 mm
P023/08.50	€ 3,38	8.50 mm	117 mm	75 mm
P023/08.60	€ 2,69	8.60 mm	125 mm	81 mm
P023/08.70	€ 2,69	8.70 mm	125 mm	81 mm
P023/08.75	€ 3,68	8.75 mm	125 mm	81 mm
P023/08.80	€ 2,69	8.80 mm	125 mm	81 mm
P023/08.90	€ 2,69	8.90 mm	125 mm	81 mm
P023/09.00	€ 3,53	9.00 mm	125 mm	81 mm
P023/09.10	€ 2,97	9.10 mm	125 mm	81 mm
P023/09.20	€ 2,97	9.20 mm	125 mm	81 mm
P023/09.25	€ 4,13	9.25 mm	125 mm	81 mm
P023/09.30	€ 2,97	9.30 mm	125 mm	81 mm
P023/09.40	€ 2,97	9.40 mm	125 mm	81 mm
P023/09.50	€ 3,75	9.50 mm	125 mm	81 mm
P023/09.60	€ 3,33	9.60 mm	133 mm	87 mm
P023/09.70	€ 3,33	9.70 mm	133 mm	87 mm
P023/09.75	€ 4,43	9.75 mm	133 mm	87 mm
P023/09.80	€ 3,33	9.80 mm	133 mm	87 mm
P023/09.90	€ 3,33	9.90 mm	133 mm	87 mm
P023/10.00	€ 4,05	10.00 mm	133 mm	87 mm
P023/10.25	€ 5,60	10.25 mm	133 mm	87 mm
P023/10.30	€ 4,16	10.30 mm	133 mm	87 mm
P023/10.40	€ 4,16	10.40 mm	133 mm	87 mm
P023/10.50	€ 4,95	10.50 mm	133 mm	87 mm
P023/10.75	€ 6,80	10.75 mm	142 mm	94 mm
P023/11.00	€ 5,90	11.00 mm	142 mm	94 mm
P023/11.25	€ 7,20	11.25 mm	142 mm	94 mm
P023/11.40	€ 5,20	11.40 mm	142 mm	94 mm
P023/11.50	€ 6,20	11.50 mm	142 mm	94 mm
P023/11.75	€ 7,80	11.75 mm	142 mm	94 mm
P023/12.00	€ 6,80	12.00 mm	151 mm	101 mm
P023/12.25	€ 8,50	12.25 mm	151 mm	101 mm
P023/12.30	€ 6,40	12.30 mm	151 mm	101 mm
P023/12.40	€ 6,40	12.40 mm	151 mm	101 mm
P023/12.50	€ 7,40	12.50 mm	151 mm	101 mm
P023/12.75	€ 9,60	12.75 mm	151 mm	101 mm
P023/13.00	€ 8,00	13.00 mm	151 mm	101 mm
P023/14.30	€ 12,90	14.30 mm	165 mm	115 mm
P023/14.40	€ 12,90	14.40 mm	165 mm	115 mm
P023/16.40	€ 16,70	16.40 mm	170 mm	115 mm

P023-xC

STRAIGHT SHANK TWIST DRILL

FULLY GROUND, RIGHT HAND, SHORT LENGTH, TO CUT MATERIALS WITH RESISTANCE R= 800 N/MM2, TWIST DRILL HARDNESS HV= 770 ÷ 830

PACKING OF 10* PIECES

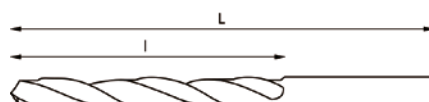

HSS DIN 1897 135°

Art.	€	ø	L	l
P023/03.00C	€ 0,75	3.00 mm	46 mm	16 mm
P023/03.25C	€ 0,83	3.25 mm	49 mm	18 mm
P023/03.50C	€ 0,83	3.50 mm	52 mm	20 mm
P023/03.75C	€ 0,90	3.75 mm	52 mm	20 mm

Art.	€	ø	L	l
P023/04.00C	€ 0,90	4.00 mm	55 mm	22 mm
P023/04.25C	€ 1,20	4.25 mm	55 mm	22 mm
P023/04.50C	€ 1,05	4.50 mm	58 mm	24 mm
P023/05.00C	€ 1,13	5.00 mm	62 mm	26 mm

Art.	€	ø	L	l
P023/05.50C	€ 1,50	5.50 mm	66 mm	28 mm
P023/06.00C	€ 1,58	6.00 mm	66 mm	28 mm

P023-xL

CAT 42

LONG TYPE STRAIGHT SHANK TWIST DRILL

FULLY GROUND, RIGHT HAND, SHORT LENGTH, TO CUT MATERIALS WITH RESISTANCE R= 800 N/MM2, TWIST DRILL HARDNESS HV= 770 ÷ 830

PACKING OF 10* PIECES UNTIL Ø 7,75 MM, PACKING OF 5* PIECES FROM Ø 8,00 MM

HSS DIN 340 135°

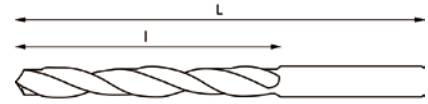

Art.	€	Ø	L	l
P023/01.00L	€ 0,83	1,00 mm	56 mm	33 mm
P023/01.25L	€ 0,83	1,25 mm	65 mm	40 mm
P023/01.50L	€ 0,83	1,50 mm	70 mm	45 mm
P023/01.75L	€ 0,83	1,75 mm	80 mm	53 mm
P023/02.00L	€ 0,75	2,00 mm	85 mm	56 mm
P023/02.25L	€ 0,83	2,25 mm	90 mm	59 mm
P023/02.50L	€ 0,75	2,50 mm	95 mm	62 mm
P023/02.75L	€ 0,90	2,75 mm	100 mm	66 mm
P023/03.00L	€ 0,83	3,00 mm	100 mm	66 mm
P023/03.25L	€ 0,90	3,25 mm	106 mm	69 mm
P023/03.50L	€ 0,90	3,50 mm	112 mm	73 mm
P023/03.75L	€ 1,05	3,75 mm	112 mm	73 mm
P023/04.00L	€ 0,98	4,00 mm	119 mm	78 mm
P023/04.25L	€ 1,13	4,25 mm	119 mm	78 mm
P023/04.50L	€ 1,13	4,50 mm	126 mm	82 mm

Art.	€	Ø	L	l
P023/04.75L	€ 1,35	4,75 mm	126 mm	82 mm
P023/05.00L	€ 1,35	5,00 mm	132 mm	87 mm
P023/05.25L	€ 1,65	5,25 mm	132 mm	87 mm
P023/05.50L	€ 1,65	5,50 mm	139 mm	91 mm
P023/05.75L	€ 1,80	5,75 mm	139 mm	91 mm
P023/06.00L	€ 1,80	6,00 mm	139 mm	91 mm
P023/06.25L	€ 2,25	6,25 mm	148 mm	97 mm
P023/06.50L	€ 2,25	6,50 mm	148 mm	97 mm
P023/06.75L	€ 2,33	6,75 mm	148 mm	97 mm
P023/07.00L	€ 2,33	7,00 mm	156 mm	102 mm
P023/07.25L	€ 2,70	7,25 mm	156 mm	102 mm
P023/07.50L	€ 2,70	7,50 mm	156 mm	102 mm
P023/07.75L	€ 3,23	7,75 mm	165 mm	109 mm
P023/08.00L	€ 3,08	8,00 mm	165 mm	109 mm
P023/08.25L	€ 4,35	8,25 mm	165 mm	109 mm

Art.	€	Ø	L	l
P023/08.50L	€ 4,35	8,50 mm	165 mm	109 mm
P023/08.75L	€ 4,50	8,75 mm	175 mm	115 mm
P023/09.00L	€ 4,50	9,00 mm	175 mm	115 mm
P023/09.25L	€ 5,10	9,25 mm	175 mm	115 mm
P023/09.50L	€ 5,10	9,50 mm	175 mm	115 mm
P023/09.75L	€ 5,10	9,75 mm	184 mm	121 mm
P023/10.00L	€ 5,10	10,00 mm	184 mm	121 mm
P023/10.25L	€ 7,10	10,25 mm	184 mm	121 mm
P023/10.50L	€ 7,10	10,50 mm	184 mm	121 mm
P023/11.00L	€ 8,30	11,00 mm	195 mm	128 mm
P023/11.50L	€ 9,00	11,50 mm	195 mm	128 mm
P023/12.00L	€ 10,50	12,00 mm	205 mm	134 mm
P023/12.50L	€ 11,60	12,50 mm	205 mm	134 mm
P023/13.00L	€ 12,20	13,00 mm	205 mm	134 mm

P023-xL1

CAT 42

EXTRA LONG TYPE STRAIGHT SHANK TWIST DRILL

FULLY GROUND, RIGHT HAND, SHORT LENGTH, TO CUT MATERIALS WITH RESISTANCE R= 800 N/MM2, TWIST DRILL HARDNESS HV= 770 ÷ 830

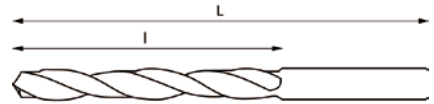

HSS DIN 1869-1 135°

Art.	€	Ø	L	l
P023/02.00L1	€ 1,35	02,00 mm	125 mm	85 mm
P023/02.50L1	€ 1,50	02,50 mm	140 mm	95 mm
P023/03.00L1	€ 1,88	03,00 mm	150 mm	100 mm
P023/03.50L1	€ 2,25	03,50 mm	165 mm	115 mm
P023/04.00L1	€ 3,00	04,00 mm	175 mm	120 mm
P023/04.50L1	€ 3,75	04,50 mm	185 mm	125 mm
P023/05.00L1	€ 4,50	05,00 mm	195 mm	135 mm
P023/05.50L1	€ 5,30	05,50 mm	205 mm	140 mm

Art.	€	Ø	L	l
P023/06.00L1	€ 6,80	06,00 mm	205 mm	140 mm
P023/06.50L1	€ 7,50	06,50 mm	215 mm	150 mm
P023/07.00L1	€ 9,00	07,00 mm	225 mm	155 mm
P023/07.50L1	€ 9,80	07,50 mm	225 mm	155 mm
P023/08.00L1	€ 12,00	08,00 mm	240 mm	165 mm
P023/08.50L1	€ 13,50	08,50 mm	240 mm	165 mm
P023/09.00L1	€ 15,00	09,00 mm	250 mm	175 mm
P023/09.50L1	€ 16,50	09,50 mm	250 mm	175 mm

Art.	€	Ø	L	l
P023/10.00L1	€ 18,80	10,00 mm	265 mm	185 mm
P023/10.50L1	€ 20,30	10,50 mm	265 mm	185 mm
P023/11.00L1	€ 22,50	11,00 mm	280 mm	195 mm
P023/11.50L1	€ 24,80	11,50 mm	280 mm	195 mm
P023/12.00L1	€ 26,30	12,00 mm	295 mm	205 mm
P023/12.50L1	€ 27,80	12,50 mm	295 mm	205 mm
P023/13.00L1	€ 29,30	13,00 mm	295 mm	205 mm

P023-xL2

CAT 42

EXTRA LONG TYPE STRAIGHT SHANK TWIST DRILL

FULLY GROUND, RIGHT HAND, SHORT LENGTH, TO CUT MATERIALS WITH RESISTANCE R= 800 N/MM2, TWIST DRILL HARDNESS HV= 770 ÷ 830

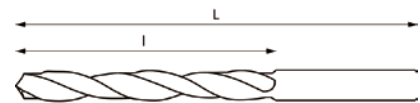

HSS DIN 1869-2 135°

Art.	€	Ø	L	l
P023/02.00L2	€ 1,88	02,00 mm	160 mm	110 mm
P023/02.50L2	€ 2,25	02,50 mm	180 mm	120 mm
P023/03.00L2	€ 2,70	03,00 mm	190 mm	130 mm
P023/03.50L2	€ 3,00	03,50 mm	210 mm	145 mm
P023/04.00L2	€ 4,50	04,00 mm	220 mm	150 mm
P023/04.50L2	€ 5,30	04,50 mm	235 mm	160 mm
P023/05.00L2	€ 6,80	05,00 mm	245 mm	170 mm
P023/05.50L2	€ 7,50	05,50 mm	260 mm	180 mm

Art.	€	Ø	L	l
P023/06.00L2	€ 9,00	06,00 mm	260 mm	180 mm
P023/06.50L2	€ 10,50	06,50 mm	275 mm	190 mm
P023/07.00L2	€ 12,80	07,00 mm	290 mm	200 mm
P023/07.50L2	€ 13,50	07,50 mm	290 mm	200 mm
P023/08.00L2	€ 16,50	08,00 mm	305 mm	210 mm
P023/08.50L2	€ 18,00	08,50 mm	305 mm	210 mm
P023/09.00L2	€ 20,30	09,00 mm	320 mm	220 mm
P023/09.50L2	€ 21,00	09,50 mm	320 mm	220 mm

Art.	€	Ø	L	l
P023/10.00L2	€ 25,50	10,00 mm	340 mm	235 mm
P023/10.50L2	€ 27,00	10,50 mm	340 mm	235 mm
P023/11.00L2	€ 31,50	11,00 mm	365 mm	250 mm
P023/11.50L2	€ 33,80	11,50 mm	365 mm	250 mm
P023/12.00L2	€ 35,30	12,00 mm	375 mm	260 mm
P023/12.50L2	€ 37,50	12,50 mm	375 mm	260 mm
P023/13.00L2	€ 41,30	13,00 mm	375 mm	260 mm

P023-xL3

CAT 42

EXTRA LONG TYPE STRAIGHT SHANK TWIST DRILL

FULLY GROUND, RIGHT HAND, TO CUT MATERIALS WITH RESISTANCE R= 800 N/MM2, TWIST DRILL HARDNESS HV= 770 ÷ 830

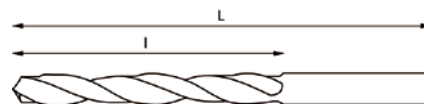

HSS DIN 1869-3 135°

Art.	€	ø	L	l	Art.	€	ø	L	l	Art.	€	ø	L	l
P023/02.00L3	€ 2,25	02,00 mm	200 mm	135 mm	P023/06.00L3	€ 11,30	06,00 mm	330 mm	225 mm	P023/10.00L3	€ 32,30	10,00 mm	430 mm	295 mm
P023/02.50L3	€ 2,63	02,50 mm	225 mm	150 mm	P023/06.50L3	€ 13,50	06,50 mm	350 mm	235 mm	P023/10.50L3	€ 34,50	10,50 mm	430 mm	295 mm
P023/03.00L3	€ 3,00	03,00 mm	240 mm	160 mm	P023/07.00L3	€ 16,50	07,00 mm	370 mm	250 mm	P023/11.00L3	€ 37,50	11,00 mm	455 mm	310 mm
P023/03.50L3	€ 4,50	03,50 mm	265 mm	180 mm	P023/07.50L3	€ 18,00	07,50 mm	370 mm	250 mm	P023/11.50L3	€ 39,80	11,50 mm	455 mm	310 mm
P023/04.00L3	€ 5,30	04,00 mm	280 mm	190 mm	P023/08.00L3	€ 21,00	08,00 mm	390 mm	265 mm	P023/12.00L3	€ 45,00	12,00 mm	480 mm	330 mm
P023/04.50L3	€ 6,80	04,50 mm	295 mm	200 mm	P023/08.50L3	€ 23,30	08,50 mm	390 mm	265 mm	P023/12.50L3	€ 48,80	12,50 mm	480 mm	330 mm
P023/05.00L3	€ 8,30	05,00 mm	315 mm	210 mm	P023/09.00L3	€ 27,00	09,00 mm	410 mm	280 mm	P023/13.00L3	€ 51,80	13,00 mm	480 mm	330 mm
P023/05.50L3	€ 9,80	05,50 mm	330 mm	225 mm	P023/09.50L3	€ 27,80	09,50 mm	410 mm	280 mm					

P023/19

€ 30,50

STRAIGHT SHANK TWIST DRILL SET

RIGHT HAND, SHORT LENGTH, TO CUT MATERIALS WITH RESISTANCE R= 800 N/MM2, TWIST DRILL HARDNESS HV= 770 ÷ 830



19 Pcs HSS DIN 338 135°

Size (step 0,5 mm)	1 ÷ 10 mm
Pieces	19

P023/25

€ 61,80

STRAIGHT SHANK TWIST DRILL SET

RIGHT HAND, SHORT LENGTH, TO CUT MATERIALS WITH RESISTANCE R= 800 N/MM2, TWIST DRILL HARDNESS HV= 770 ÷ 830



25 Pcs HSS DIN 338 135°

Size (step 0,5 mm)	1 ÷ 13 mm
Pieces	25



P065-

FULLY GROUND FROM THE SOLID

SPLIT POINT, RIGHT HAND, SHORT LENGTH, TO CUT MATERIALS WITH RESISTANCE R= 1250 N/mm², TWIST DRILL, HARDNESS HV= 800 ÷ 900

PACKING OF 10* PIECES UNTIL Ø 7,75 MM, PACKING OF 5* PIECES FROM Ø 8,00 MM

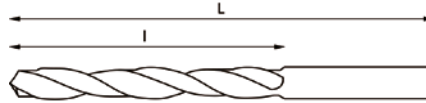

HSS - Co 5% DIN 338 135°

Art.	€	Ø	L	l
P065/01.00	€ 0,86	1 mm	34 mm	12 mm
P065/01.25	€ 1,04	1,25 mm	38 mm	16 mm
P065/01.50	€ 1,04	1,50 mm	40 mm	18 mm
P065/01.75	€ 1,04	1,75 mm	46 mm	22 mm
P065/02.00	€ 1,04	2 mm	49 mm	24 mm
P065/02.25	€ 1,20	2,25 mm	53 mm	27 mm
P065/02.50	€ 1,20	2,50 mm	57 mm	30 mm
P065/02.75	€ 1,20	2,75 mm	61 mm	33 mm
P065/03.00	€ 1,20	3 mm	61 mm	33 mm
P065/03.25	€ 1,64	3,25 mm	69 mm	39 mm
P065/03.50	€ 1,64	3,50 mm	70 mm	39 mm
P065/03.75	€ 1,64	3,75 mm	70 mm	39 mm
P065/04.00	€ 1,64	4 mm	75 mm	43 mm
P065/04.25	€ 2,31	4,25 mm	75 mm	43 mm
P065/04.50	€ 2,31	4,50 mm	80 mm	47 mm
P065/04.75	€ 2,31	4,75 mm	80 mm	47 mm
P065/05.00	€ 2,31	5 mm	86 mm	52 mm

Art.	€	Ø	L	l
P065/05.25	€ 2,91	5,25 mm	86 mm	52 mm
P065/05.50	€ 2,91	5,50 mm	93 mm	57 mm
P065/05.75	€ 2,91	5,75 mm	93 mm	57 mm
P065/06.00	€ 2,91	6 mm	93 mm	57 mm
P065/06.25	€ 3,60	6,25 mm	101 mm	63 mm
P065/06.50	€ 3,60	6,50 mm	101 mm	63 mm
P065/06.75	€ 3,60	6,75 mm	109 mm	69 mm
P065/07.00	€ 3,60	7 mm	109 mm	69 mm
P065/07.25	€ 6,20	7,25 mm	109 mm	69 mm
P065/07.50	€ 6,20	7,50 mm	109 mm	69 mm
P065/07.75	€ 6,20	7,75 mm	117 mm	75 mm
P065/08.00	€ 6,20	8 mm	117 mm	75 mm
P065/08.25	€ 7,70	8,25 mm	117 mm	75 mm
P065/08.50	€ 7,70	8,50 mm	117 mm	75 mm
P065/08.75	€ 7,70	8,75 mm	125 mm	81 mm
P065/09.00	€ 7,70	9 mm	125 mm	81 mm
P065/09.25	€ 9,70	9,25 mm	125 mm	81 mm

Art.	€	Ø	L	l
P065/09.50	€ 9,70	9,50 mm	125 mm	81 mm
P065/09.75	€ 9,70	9,75 mm	133 mm	87 mm
P065/10.00	€ 9,70	10 mm	133 mm	87 mm
P065/10.25	€ 11,60	10,25 mm	133 mm	87 mm
P065/10.50	€ 11,60	10,50 mm	133 mm	87 mm
P065/10.75	€ 11,60	10,75 mm	142 mm	94 mm
P065/11.00	€ 11,60	11 mm	142 mm	94 mm
P065/11.25	€ 13,90	11,25 mm	142 mm	94 mm
P065/11.50	€ 13,90	11,50 mm	142 mm	94 mm
P065/11.75	€ 13,90	11,75 mm	142 mm	94 mm
P065/12.00	€ 13,90	12 mm	151 mm	101 mm
P065/12.25	€ 16,80	12,25 mm	151 mm	101 mm
P065/12.50	€ 16,80	12,50 mm	151 mm	101 mm
P065/12.75	€ 16,80	12,75 mm	151 mm	101 mm
P065/13.00	€ 16,80	13 mm	151 mm	101 mm

P067

€ 56,60

FULLY GROUND FROM THE SOLID COBALT TWIST DRILL SET

SPLIT POINT, RIGHT HAND, SHORT LENGTH, TO CUT MATERIALS WITH RESISTANCE R= 1250 N/mm², TWIST DRILL, HARDNESS HV= 800 ÷ 900



19 Pcs HSS - Co 5% DIN 338 135°

Size (step 0,5 mm)	1 ÷ 10 mm
Pieces	19

P069

€ 111,00

FULLY GROUND FROM THE SOLID COBALT TWIST DRILL SET

SPLIT POINT, RIGHT HAND, SHORT LENGTH, TO CUT MATERIALS WITH RESISTANCE R= 1250 N/mm², TWIST DRILL, HARDNESS HV= 800 ÷ 900



25 Pcs HSS - Co 5% DIN 338 135°

Size (step 0,5 mm)	1 ÷ 13 mm
Pieces	25



P064-

FULLY GROUND FROM THE SOLID TWIST DRILL

SPLIT POINT, RIGHT HAND, SHORT LENGTH, TO CUT MATERIALS WITH RESISTANCE R= 1400 N/MM², TWIST DRILL, HARDNESS HV= 850 ÷ 900

PACKING OF 10* PIECES UNTIL Ø 7,75 MM, PACKING OF 5* PIECES FROM Ø 8,00 MM

DIN 338 135° HSS - Co 8%

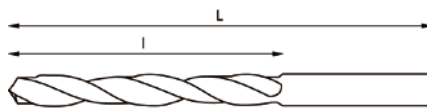

Art.	€	Ø	L	l
P064/01.00	€ 1,20	01.00 mm	34 mm	12 mm
P064/01.25	€ 1,20	01.25 mm	38 mm	16 mm
P064/01.50	€ 1,20	01.50 mm	40 mm	18 mm
P064/01.75	€ 1,20	01.75 mm	46 mm	22 mm
P064/02.00	€ 1,20	02.00 mm	49 mm	24 mm
P064/02.25	€ 1,39	02.25 mm	53 mm	27 mm
P064/02.50	€ 1,39	02.50 mm	57 mm	30 mm
P064/02.75	€ 1,39	02.75 mm	61 mm	33 mm
P064/03.00	€ 1,39	03.00 mm	61 mm	33 mm
P064/03.25	€ 1,90	03.25 mm	69 mm	39 mm
P064/03.50	€ 1,90	03.50 mm	70 mm	39 mm
P064/03.75	€ 1,90	03.75 mm	70 mm	39 mm
P064/04.00	€ 1,90	04.00 mm	75 mm	43 mm
P064/04.25	€ 2,68	04.25 mm	75 mm	43 mm
P064/04.50	€ 2,68	04.50 mm	80 mm	47 mm
P064/04.75	€ 2,68	04.75 mm	80 mm	47 mm
P064/05.00	€ 2,68	05.00 mm	86 mm	52 mm

Art.	€	Ø	L	l
P064/05.25	€ 3,38	05.25 mm	86 mm	52 mm
P064/05.50	€ 3,38	05.50 mm	93 mm	57 mm
P064/05.75	€ 3,38	05.75 mm	93 mm	57 mm
P064/06.00	€ 3,38	06.00 mm	93 mm	57 mm
P064/06.25	€ 4,12	06.25 mm	101 mm	63 mm
P064/06.50	€ 4,12	06.50 mm	101 mm	63 mm
P064/06.75	€ 4,12	06.75 mm	109 mm	69 mm
P064/07.00	€ 4,12	07.00 mm	109 mm	69 mm
P064/07.25	€ 7,20	07.25 mm	109 mm	69 mm
P064/07.50	€ 7,20	07.50 mm	109 mm	69 mm
P064/07.75	€ 7,20	07.75 mm	117 mm	75 mm
P064/08.00	€ 7,20	08.00 mm	117 mm	75 mm
P064/08.25	€ 8,90	08.25 mm	117 mm	75 mm
P064/08.50	€ 8,90	08.50 mm	117 mm	75 mm
P064/08.75	€ 8,90	08.75 mm	125 mm	81 mm
P064/09.00	€ 8,90	09.00 mm	125 mm	81 mm
P064/09.25	€ 11,20	09.25 mm	125 mm	81 mm

Art.	€	Ø	L	l
P064/09.50	€ 11,20	09.50 mm	125 mm	81 mm
P064/09.75	€ 11,20	09.75 mm	133 mm	87 mm
P064/10.00	€ 11,20	10.00 mm	133 mm	87 mm
P064/10.25	€ 13,50	10.25 mm	133 mm	87 mm
P064/10.50	€ 13,50	10.50 mm	133 mm	87 mm
P064/10.75	€ 13,50	10.75 mm	142 mm	94 mm
P064/11.00	€ 13,50	11.00 mm	142 mm	94 mm
P064/11.25	€ 16,10	11.25 mm	142 mm	94 mm
P064/11.50	€ 16,10	11.50 mm	142 mm	94 mm
P064/11.75	€ 16,10	11.75 mm	142 mm	94 mm
P064/12.00	€ 16,10	12.00 mm	151 mm	101 mm
P064/12.25	€ 19,50	12.25 mm	151 mm	101 mm
P064/12.50	€ 19,50	12.50 mm	151 mm	101 mm
P064/12.75	€ 19,50	12.75 mm	151 mm	101 mm
P064/13.00	€ 19,50	13.00 mm	151 mm	101 mm

P064/19A

€ 68,50

FULLY GROUND FROM THE SOLID COBALT TWIST DRILL SET

SPLIT POINT, RIGHT HAND, SHORT LENGTH, TO CUT MATERIALS WITH RESISTANCE R= 1400 N/MM², TWIST DRILL, HARDNESS HV= 850 ÷ 900



19 Pcs DIN338 135° HSS - Co 8%

Size (step 0,5 mm)

1 ÷ 10 mm

P064/25A

€ 146,00

FULLY GROUND FROM THE SOLID COBALT TWIST DRILL SET

SPLIT POINT, RIGHT HAND, SHORT LENGTH, TO CUT MATERIALS WITH RESISTANCE R= 1400 N/MM², TWIST DRILL, HARDNESS HV= 850 ÷ 900



25 Pcs DIN338 135° HSS - Co 8%

Size (step 0,5 mm)

1 ÷ 13 mm



ST2Ax

MORSE TAPER SHANK TWIST DRILL, BLACK FINISHED

RIGHT HAND, TO CUT MATERIALS WITH RESISTANCE R= 650 N/mm2, TWIST DRILL HARDNESS HV= 700 ÷ 740



HSS DIN 345/N 118°

Art.	€	ø	MT	L	l	Art.	€	ø	MT	L	l	Art.	€	ø	MT	L	l
ST2A05.75	€ 7,10	5,75 mm	1	138 mm	57 mm	ST2A20	€ 18,00	20,00 mm	2	238 mm	140 mm	ST2A36.50	€ 68,50	36,50 mm	4	344 mm	195 mm
ST2A06	€ 7,10	6,00 mm	1	138 mm	57 mm	ST2A20.25	€ 18,00	20,25 mm	2	243 mm	145 mm	ST2A37	€ 68,50	37,00 mm	4	344 mm	195 mm
ST2A06.25	€ 7,10	6,25 mm	1	144 mm	63 mm	ST2A20.50	€ 20,90	20,50 mm	2	243 mm	145 mm	ST2A37.50	€ 68,50	37,50 mm	4	344 mm	195 mm
ST2A06.50	€ 7,10	6,50 mm	1	144 mm	63 mm	ST2A20.75	€ 20,90	20,75 mm	2	243 mm	145 mm	ST2A38	€ 68,50	38,00 mm	4	349 mm	200 mm
ST2A06.75	€ 7,10	6,75 mm	1	150 mm	69 mm	ST2A21	€ 20,90	21,00 mm	2	243 mm	145 mm	ST2A38.50	€ 78,80	38,50 mm	4	349 mm	200 mm
ST2A07	€ 7,10	7,00 mm	1	150 mm	69 mm	ST2A21.25	€ 23,00	21,25 mm	2	248 mm	150 mm	ST2A39	€ 78,80	39,00 mm	4	349 mm	200 mm
ST2A07.25	€ 7,10	7,25 mm	1	150 mm	69 mm	ST2A21.50	€ 23,00	21,50 mm	2	248 mm	150 mm	ST2A39.50	€ 78,80	39,50 mm	4	349 mm	200 mm
ST2A07.50	€ 7,10	7,50 mm	1	150 mm	69 mm	ST2A21.75	€ 23,00	21,75 mm	2	248 mm	150 mm	ST2A40	€ 78,80	40,00 mm	4	349 mm	200 mm
ST2A07.75	€ 7,10	7,75 mm	1	156 mm	75 mm	ST2A22	€ 23,00	22,00 mm	2	248 mm	150 mm	ST2A40.50	€ 88,50	40,50 mm	4	354 mm	205 mm
ST2A08	€ 7,10	8,00 mm	1	156 mm	75 mm	ST2A22.25	€ 24,20	22,25 mm	2	248 mm	150 mm	ST2A41	€ 88,50	41,00 mm	4	354 mm	205 mm
ST2A08.25	€ 7,10	8,25 mm	1	156 mm	75 mm	ST2A22.50	€ 24,20	22,50 mm	2	253 mm	155 mm	ST2A41.50	€ 88,50	41,50 mm	4	354 mm	205 mm
ST2A08.50	€ 7,10	8,50 mm	1	156 mm	75 mm	ST2A22.75	€ 24,20	22,75 mm	2	253 mm	155 mm	ST2A42	€ 88,50	42,00 mm	4	354 mm	205 mm
ST2A08.75	€ 7,10	8,75 mm	1	156 mm	75 mm	ST2A23	€ 24,20	23,00 mm	2	253 mm	155 mm	ST2A42.50	€ 97,50	42,50 mm	4	354 mm	205 mm
ST2A09	€ 7,10	9,00 mm	1	162 mm	81 mm	ST2A23.25	€ 24,20	23,25 mm	3	276 mm	155 mm	ST2A43	€ 97,50	43,00 mm	4	359 mm	210 mm
ST2A09.25	€ 7,10	9,25 mm	1	162 mm	81 mm	ST2A23.50	€ 26,70	23,50 mm	3	276 mm	155 mm	ST2A43.50	€ 97,50	43,50 mm	4	359 mm	210 mm
ST2A09.50	€ 7,10	9,50 mm	1	162 mm	81 mm	ST2A23.75	€ 26,70	23,75 mm	3	281 mm	160 mm	ST2A44	€ 97,50	44,00 mm	4	359 mm	210 mm
ST2A09.75	€ 7,10	9,75 mm	1	162 mm	81 mm	ST2A24	€ 26,70	24,00 mm	3	281 mm	160 mm	ST2A44.50	€ 97,50	44,50 mm	4	359 mm	210 mm
ST2A10	€ 7,10	10,00 mm	1	168 mm	81 mm	ST2A24.25	€ 29,60	24,25 mm	3	281 mm	160 mm	ST2A45	€ 109,00	45,00 mm	4	359 mm	210 mm
ST2A10.25	€ 8,20	10,25 mm	1	168 mm	87 mm	ST2A24.50	€ 29,60	24,50 mm	3	281 mm	160 mm	ST2A45.50	€ 109,00	45,50 mm	4	364 mm	215 mm
ST2A10.50	€ 8,20	10,50 mm	1	168 mm	87 mm	ST2A24.75	€ 29,60	24,75 mm	3	281 mm	160 mm	ST2A46	€ 109,00	46,00 mm	4	364 mm	215 mm
ST2A10.75	€ 8,20	10,75 mm	1	175 mm	87 mm	ST2A25	€ 29,60	25,00 mm	3	281 mm	160 mm	ST2A46.50	€ 126,00	46,50 mm	4	364 mm	215 mm
ST2A11	€ 8,20	11,00 mm	1	175 mm	94 mm	ST2A25.25	€ 31,70	25,25 mm	3	281 mm	160 mm	ST2A47	€ 126,00	47,00 mm	4	364 mm	215 mm
ST2A11.25	€ 8,20	11,25 mm	1	175 mm	94 mm	ST2A25.50	€ 31,70	25,50 mm	3	281 mm	160 mm	ST2A47.50	€ 126,00	47,50 mm	4	364 mm	215 mm
ST2A11.50	€ 8,20	11,50 mm	1	175 mm	94 mm	ST2A25.75	€ 31,70	25,75 mm	3	281 mm	160 mm	ST2A48	€ 126,00	48,00 mm	4	369 mm	220 mm
ST2A11.75	€ 8,20	11,75 mm	1	175 mm	94 mm	ST2A26	€ 31,70	26,00 mm	3	286 mm	165 mm	ST2A48.50	€ 140,00	48,50 mm	4	369 mm	220 mm
ST2A12	€ 8,20	12,00 mm	1	182 mm	94 mm	ST2A26.25	€ 37,50	26,25 mm	3	286 mm	165 mm	ST2A49	€ 140,00	49,00 mm	4	369 mm	220 mm
ST2A12.25	€ 9,30	12,25 mm	1	182 mm	101 mm	ST2A26.50	€ 37,50	26,50 mm	3	286 mm	165 mm	ST2A49.50	€ 140,00	49,50 mm	4	369 mm	220 mm
ST2A12.50	€ 9,30	12,50 mm	1	182 mm	101 mm	ST2A26.75	€ 37,50	26,75 mm	3	291 mm	170 mm	ST2A50	€ 142,00	50,00 mm	4	369 mm	220 mm
ST2A12.75	€ 9,30	12,75 mm	1	182 mm	101 mm	ST2A27	€ 37,50	27,00 mm	3	291 mm	170 mm	ST2A50.50	€ 146,00	50,50 mm	4	374 mm	225 mm
ST2A13	€ 9,30	13,00 mm	1	182 mm	101 mm	ST2A27.25	€ 37,50	27,25 mm	3	291 mm	170 mm	ST2A51	€ 151,00	51,00 mm	5	412 mm	225 mm
ST2A13.25	€ 9,30	13,25 mm	1	182 mm	101 mm	ST2A27.50	€ 37,50	27,50 mm	3	291 mm	170 mm	ST2A51.50	€ 156,00	51,50 mm	5	412 mm	225 mm
ST2A13.50	€ 9,30	13,50 mm	1	189 mm	108 mm	ST2A27.75	€ 37,50	27,75 mm	3	291 mm	170 mm	ST2A52	€ 164,00	52,00 mm	5	412 mm	225 mm
ST2A13.75	€ 9,30	13,75 mm	1	189 mm	108 mm	ST2A28	€ 37,50	28,00 mm	3	291 mm	170 mm	ST2A53	€ 164,00	53,00 mm	5	412 mm	225 mm
ST2A14	€ 9,30	14,00 mm	1	189 mm	108 mm	ST2A28.25	€ 42,10	28,25 mm	3	296 mm	175 mm	ST2A54	€ 164,00	54,00 mm	5	417 mm	230 mm
ST2A14.25	€ 9,30	14,25 mm	2	212 mm	114 mm	ST2A28.50	€ 42,10	28,50 mm	3	296 mm	175 mm	ST2A55	€ 164,00	55,00 mm	5	417 mm	230 mm
ST2A14.50	€ 9,30	14,50 mm	2	212 mm	114 mm	ST2A28.75	€ 42,10	28,75 mm	3	296 mm	175 mm	ST2A56	€ 191,00	56,00 mm	5	417 mm	230 mm
ST2A14.75	€ 9,30	14,75 mm	2	212 mm	114 mm	ST2A29	€ 42,10	29,00 mm	3	296 mm	175 mm	ST2A57	€ 191,00	57,00 mm	5	422 mm	235 mm
ST2A15	€ 9,30	15,00 mm	2	212 mm	114 mm	ST2A29.25	€ 42,10	29,25 mm	3	296 mm	175 mm	ST2A58	€ 191,00	58,00 mm	5	422 mm	235 mm
ST2A15.25	€ 13,90	15,25 mm	2	218 mm	120 mm	ST2A29.50	€ 42,10	29,50 mm	3	296 mm	175 mm	ST2A59	€ 191,00	59,00 mm	5	422 mm	235 mm
ST2A15.50	€ 13,90	15,50 mm	2	218 mm	120 mm	ST2A29.75	€ 42,10	29,75 mm	3	296 mm	175 mm	ST2A60	€ 191,00	60,00 mm	5	422 mm	235 mm
ST2A15.75	€ 13,90	15,75 mm	2	218 mm	120 mm	ST2A30	€ 42,10	30,00 mm	3	296 mm	175 mm	ST2A61	€ 228,00	61,00 mm	5	427 mm	240 mm
ST2A16	€ 13,90	16,00 mm	2	218 mm	120 mm	ST2A30.25	€ 42,90	30,25 mm	3	301 mm	180 mm	ST2A62	€ 247,00	62,00 mm	5	427 mm	240 mm
ST2A16.25	€ 13,90	16,25 mm	2	223 mm	125 mm	ST2A30.50	€ 42,90	30,50 mm	3	301 mm	180 mm	ST2A63	€ 283,00	63,00 mm	5	427 mm	240 mm
ST2A16.50	€ 13,90	16,50 mm	2	223 mm	125 mm	ST2A30.75	€ 42,90	30,75 mm	3	301 mm	180 mm	ST2A65	€ 283,00	65,00 mm	5	432 mm	245 mm
ST2A16.75	€ 13,90	16,75 mm	2	223 mm	125 mm	ST2A31	€ 42,90	31,00 mm	3	301 mm	180 mm	ST2A66	€ 283,00	66,00 mm	5	432 mm	245 mm
ST2A17	€ 13,90	17,00 mm	2	223 mm	125 mm	ST2A31.25	€ 44,60	31,25 mm	3	301 mm	180 mm	ST2A67	€ 286,00	67,00 mm	5	432 mm	245 mm
ST2A17.25	€ 13,90	17,25 mm	2	228 mm	130 mm	ST2A31.50	€ 44,60	31,50 mm	3	301 mm	180 mm	ST2A68	€ 294,00	68,00 mm	5	437 mm	250 mm
ST2A17.50	€ 13,90	17,50 mm	2	228 mm	130 mm	ST2A31.75	€ 44,60	31,75 mm	4	306 mm	185 mm	ST2A69	€ 297,00	69,00 mm	5	437 mm	250 mm
ST2A17.75	€ 13,90	17,75 mm	2	228 mm	130 mm	ST2A32	€ 44,60	32,00 mm	4	334 mm	185 mm	ST2A70	€ 297,00	70,00 mm	5	437 mm	250 mm
ST2A18	€ 17,00	18,00 mm	2	228 mm	130 mm	ST2A32.50	€ 58,60	32,50 mm	4	334 mm	185 mm	ST2A71	€ 297,00	71,00 mm	5	437 mm	250 mm
ST2A18.25	€ 17,00	18,25 mm	2	233 mm	135 mm	ST2A33	€ 58,60	33,00 mm	4	334 mm	185 mm	ST2A72	€ 297,00	72,00 mm	5	442 mm	255 mm
ST2A18.50	€ 17,00	18,50 mm	2	233 mm	135 mm	ST2A33.50	€ 58,60	33,50 mm	4	334 mm	185 mm	ST2A73	€ 337,00	73,00 mm	5	442 mm	255 mm
ST2A18.75	€ 17,00	18,75 mm	2	233 mm	135 mm	ST2A34	€ 58,60	34,00 mm	4	339 mm	190 mm	ST2A74	€ 337,00	74,00 mm	5	442 mm	255 mm
ST2A19	€ 17,00	19,00 mm	2	233 mm	135 mm	ST2A34.50	€ 58,60	34,50 mm	4	339 mm	190 mm	ST2A75	€ 353,00	75,00 mm	5	442 mm	255 mm
ST2A19.25	€ 18,00	19,25 mm	2	238 mm	140 mm	ST2A35	€ 58,60	35,00 mm	4	339 mm	190 mm	ST2A77	€ 412,00	77,00 mm	6	514 mm	260 mm
ST2A19.50	€ 18,00	19,50 mm	2	238 mm	140 mm	ST2A35.50	€ 68,50	35,50 mm	4	339 mm	190 mm	ST2A78	€ 541,00	78,00 mm	6	514 mm	260 mm
ST2A19.75	€ 18,00	19,75 mm	2	238 mm	140 mm	ST2A36	€ 68,50	36,00 mm	4	344 mm	195 mm	ST2A79	€ 707,00	79,00 mm	6	514 mm	260 mm



P057

€ 86,30

MORSE TAPER SHANK TWIST DRILL SET , BLACK FINISHED



10 Pcs HSS DIN 345/N 118°

MT 1	14 mm
MT 2	15 - 16 - 17 - 18 - 19 - 20 - 21 - 22 - 23 mm
Pieces	10

P056/10S

CAT 42 € 29,20

CENTER DRILL SET



10 HSS DIN 333 60°

Sizes	2 x 1,00 mm - 2 x 1,60 mm - 2 x 3,15 mm - 1 x 2,00 mm - 1 x 2,50
Type	A
Tolerance	K12 mm

P036-

CAT 42

SPOT DRILLS



HSS - Co 5% DIN 1897

Art.	€	Ø	Total length
P036/06	€ 5,00	6 mm	66 mm
P036/07	€ 7,10	7 mm	74 mm
P036/08	€ 7,50	8 mm	79 mm
P036/10	€ 8,30	10 mm	89 mm

P056-

CENTER DRILL



HSS DIN 333 60°

Art.	€	Ø	Shank	Length
P056/1	€ 2,06	1 mm	Ø 3 mm	30,5 mm
P056/1.6	€ 2,06	1,6 mm	Ø 4 mm	35,5 mm
P056/2	€ 3,09	2 mm	Ø 5 mm	40 mm
P056/2.5	€ 3,26	2,5 mm	Ø 6,3 mm	45 mm
P056/3.15	€ 3,60	3,15 mm	Ø 8 mm	50 mm
P056/4	€ 6,40	4 mm	Ø 10 mm	56 mm
P056/5	€ 8,60	5 mm	Ø 12,5 mm	63 mm

P037-

CAT 42

MILLING DRILLS



HSS TiN

Art.	€	Ø	Shank	Total length
P037/6	€ 2,29	6 mm	6 mm	90 mm
P037/8	€ 3,42	8 mm	8 mm	90 mm

F011-xP

CAT 42

TWIST DRILLS WELDON SHANK

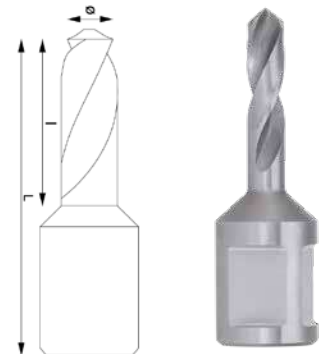

HSS 135°

Art.	€	Ø	l	L
F011/006P	€ 24,20	6 mm	30 mm	62 mm
F011/007P	€ 24,20	7 mm	30 mm	62 mm
F011/008P	€ 24,20	8 mm	30 mm	62 mm
F011/009P	€ 26,70	9 mm	30 mm	62 mm
F011/010P	€ 26,70	10 mm	30 mm	62 mm
F011/011P	€ 29,20	11 mm	30 mm	62 mm

F011-

UNIVERSAL HOLE CUTTERS WITH WELDON SHANK

19,05 mm WELDON SHANK FOR MAGNETIC DRILLS AND DRILL PRESSES, TO CUT MATERIALS WITH RESISTANCE R= 850 N/MM2

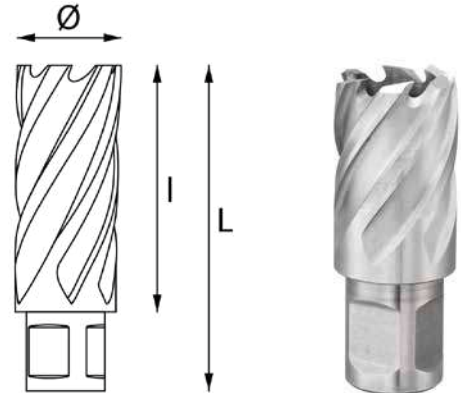

HSS

Art.	€	l	Ø	L	Art.	€	l	Ø	L	Art.	€	l	Ø	L
F011/12	€ 19,80	30 mm	12 mm	62 mm	F011/27	€ 42,40	30 mm	27 mm	62 mm	F011/42	€ 72,00	30 mm	42 mm	62 mm
F011/13	€ 20,60	30 mm	13 mm	62 mm	F011/28	€ 43,60	30 mm	28 mm	62 mm	F011/43	€ 73,30	30 mm	43 mm	62 mm
F011/14	€ 23,90	30 mm	14 mm	62 mm	F011/29	€ 44,90	30 mm	29 mm	62 mm	F011/44	€ 74,90	30 mm	44 mm	62 mm
F011/15	€ 24,70	30 mm	15 mm	62 mm	F011/30	€ 46,10	30 mm	30 mm	62 mm	F011/45	€ 87,90	30 mm	45 mm	62 mm
F011/16	€ 26,40	30 mm	16 mm	62 mm	F011/31	€ 48,10	30 mm	31 mm	62 mm	F011/46	€ 89,50	30 mm	46 mm	62 mm
F011/17	€ 27,20	30 mm	17 mm	62 mm	F011/32	€ 49,40	30 mm	32 mm	62 mm	F011/47	€ 91,00	30 mm	47 mm	62 mm
F011/18	€ 28,80	30 mm	18 mm	62 mm	F011/33	€ 50,90	30 mm	33 mm	62 mm	F011/48	€ 93,40	30 mm	48 mm	62 mm
F011/19	€ 29,60	30 mm	19 mm	62 mm	F011/34	€ 52,30	30 mm	34 mm	62 mm	F011/49	€ 95,00	30 mm	49 mm	62 mm
F011/20	€ 30,50	30 mm	20 mm	62 mm	F011/35	€ 53,50	30 mm	35 mm	62 mm	F011/50	€ 96,60	30 mm	50 mm	62 mm
F011/21	€ 30,90	30 mm	21 mm	62 mm	F011/36	€ 55,00	30 mm	36 mm	62 mm	F011/51	€ 105,00	30 mm	51 mm	62 mm
F011/22	€ 32,10	30 mm	22 mm	62 mm	F011/37	€ 56,40	30 mm	37 mm	62 mm	F011/52	€ 107,00	30 mm	52 mm	62 mm
F011/23	€ 32,90	30 mm	23 mm	62 mm	F011/38	€ 58,30	30 mm	38 mm	62 mm	F011/53	€ 109,00	30 mm	53 mm	62 mm
F011/24	€ 35,00	30 mm	24 mm	62 mm	F011/39	€ 60,00	30 mm	39 mm	62 mm	F011/54	€ 111,00	30 mm	54 mm	62 mm
F011/25	€ 36,30	30 mm	25 mm	62 mm	F011/40	€ 61,00	30 mm	40 mm	62 mm	F011/55	€ 115,00	30 mm	55 mm	62 mm
F011/26	€ 41,20	30 mm	26 mm	62 mm	F011/41	€ 70,40	30 mm	41 mm	62 mm	F011/60	€ 135,00	30 mm	60 mm	62 mm

F011/6

€ 156,00

WELDON SHANK CORE DRILL SET

FOR MAGNETIC DRILLS AND DRILL PRESSES, TO CUT MATERIALS WITH RESISTANCE R= 850 N/MM2



7 Pcs HSS

Sizes 12 x 62 - 14 x 62 - 16 x 62 - 18 x 62 - 20 x 62 - 22 x 62 mm
Shank Weldon 19,05 mm

F002-xP

CAT 42

TWIST DRILLS WELDON SHANK

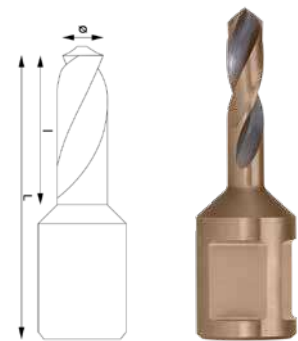

HSS - Co 5% 135°

Art.	€	Ø	l	L
F002/006P	€ 22,50	6 mm	30 mm	62.50 mm
F002/007P	€ 22,50	7 mm	30 mm	62.50 mm
F002/008P	€ 22,50	8 mm	30 mm	62.50 mm
F002/009P	€ 22,50	9 mm	30 mm	62.50 mm
F002/010P	€ 22,50	10 mm	30 mm	62.50 mm
F002/011P	€ 22,50	11 mm	30 mm	62.50 mm

F002-

UNIVERSAL HOLE CUTTER WITH WELDON SHANK

WITH 19,05 mm WELDON SHANK FOR MAGNETIC DRILLS AND DRILL PRESSES, TO CUT MATERIALS WITH RESISTANCE R= 1200 N/MM2

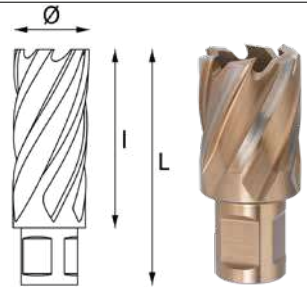

HSS - Co 5%

Art.	€	Ø	l	L
F002/12	€ 32,80	12 mm	30 mm	62 mm
F002/13	€ 34,60	13 mm	30 mm	62 mm
F002/14	€ 37,80	14 mm	30 mm	62 mm
F002/15	€ 41,20	15 mm	30 mm	62 mm
F002/16	€ 42,80	16 mm	30 mm	62 mm
F002/17	€ 42,80	17 mm	30 mm	62 mm
F002/18	€ 42,80	18 mm	30 mm	62 mm
F002/19	€ 43,60	19 mm	30 mm	62 mm
F002/20	€ 45,30	20 mm	30 mm	62 mm
F002/21	€ 46,90	21 mm	30 mm	62 mm
F002/22	€ 48,60	22 mm	30 mm	62 mm
F002/23	€ 49,80	23 mm	30 mm	62 mm
F002/24	€ 52,70	24 mm	30 mm	62 mm
F002/25	€ 54,30	25 mm	30 mm	62 mm

Art.	€	Ø	l	L
F002/26	€ 62,50	26 mm	30 mm	62 mm
F002/27	€ 65,10	27 mm	30 mm	62 mm
F002/28	€ 66,70	28 mm	30 mm	62 mm
F002/29	€ 67,50	29 mm	30 mm	62 mm
F002/30	€ 70,00	30 mm	30 mm	62 mm
F002/31	€ 73,30	31 mm	30 mm	62 mm
F002/32	€ 75,80	32 mm	30 mm	62 mm
F002/33	€ 81,50	33 mm	30 mm	62 mm
F002/34	€ 85,50	34 mm	30 mm	62 mm
F002/35	€ 88,70	35 mm	30 mm	62 mm
F002/36	€ 91,80	36 mm	30 mm	62 mm
F002/37	€ 95,80	37 mm	30 mm	62 mm
F002/38	€ 99,00	38 mm	30 mm	62 mm
F002/39	€ 104,00	39 mm	30 mm	62 mm

Art.	€	Ø	l	L
F002/40	€ 107,00	40 mm	30 mm	62 mm
F002/41	€ 111,00	41 mm	30 mm	62 mm
F002/42	€ 116,00	42 mm	30 mm	62 mm
F002/43	€ 119,00	43 mm	30 mm	62 mm
F002/44	€ 125,00	44 mm	30 mm	62 mm
F002/45	€ 133,00	45 mm	30 mm	62 mm
F002/46	€ 135,00	46 mm	30 mm	62 mm
F002/47	€ 138,00	47 mm	30 mm	62 mm
F002/48	€ 141,00	48 mm	30 mm	62 mm
F002/49	€ 145,00	49 mm	30 mm	62 mm
F002/50	€ 148,00	50 mm	30 mm	62 mm
F002/55	€ 173,00	55 mm	30 mm	62 mm
F002/60	€ 267,00	60 mm	30 mm	62 mm

F002-xPL

CAT 42

LONG TWIST DRILLS WELDON SHANK

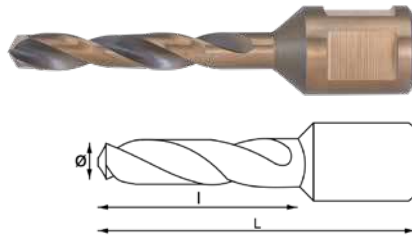

HSS - Co 5% 135°

Art.	€	Ø	l	L
F002/006PL	€ 29,20	6 mm	55 mm	86.50 mm
F002/007PL	€ 29,20	7 mm	55 mm	86.50 mm
F002/008PL	€ 29,20	8 mm	55 mm	86.50 mm
F002/009PL	€ 29,20	9 mm	55 mm	86.50 mm
F002/010PL	€ 29,20	10 mm	55 mm	86.50 mm
F002/011PL	€ 29,20	11 mm	55 mm	86.50 mm

F002/P

€ 6,60

PILOT PIN

FOR WELDON SHANK CORE DRILLS



Dimensions 6,35 x 77 mm

F002/PL

€ 8,20

PILOT PIN

FOR WELDON SHANK CORE DRILLS



Dimensions 6,35 x 102 mm

F002-xL

LONG TYPE UNIVERSAL HOLE CUTTERS WITH WELDON SHANK

19,05 mm WELDON SHANK FOR MAGNETIC DRILLS AND DRILL PRESSES, TO CUT MATERIALS WITH RESISTANCE R= 1200 N/MM2

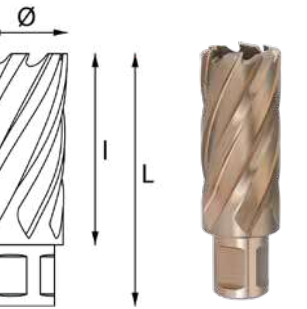

HSS - Co 5%

Art.	€	Ø	l	L
F002/12L	€ 46,10	12 mm	50 mm	85 mm
F002/13L	€ 46,90	13 mm	50 mm	85 mm
F002/14L	€ 55,20	14 mm	50 mm	85 mm
F002/15L	€ 56,00	15 mm	50 mm	85 mm
F002/16L	€ 60,10	16 mm	50 mm	85 mm
F002/17L	€ 62,50	17 mm	50 mm	85 mm
F002/18L	€ 65,10	18 mm	50 mm	85 mm
F002/19L	€ 66,70	19 mm	50 mm	85 mm
F002/20L	€ 68,30	20 mm	50 mm	85 mm
F002/21L	€ 70,00	21 mm	50 mm	85 mm
F002/22L	€ 71,60	22 mm	50 mm	85 mm
F002/23L	€ 73,30	23 mm	50 mm	85 mm
F002/24L	€ 77,40	24 mm	50 mm	85 mm
F002/25L	€ 79,00	25 mm	50 mm	85 mm

Art.	€	Ø	l	L
F002/26L	€ 91,80	26 mm	50 mm	85 mm
F002/27L	€ 93,40	27 mm	50 mm	85 mm
F002/28L	€ 95,80	28 mm	50 mm	85 mm
F002/29L	€ 97,40	29 mm	50 mm	85 mm
F002/30L	€ 99,80	30 mm	50 mm	85 mm
F002/31L	€ 105,00	31 mm	50 mm	85 mm
F002/32L	€ 108,00	32 mm	50 mm	85 mm
F002/33L	€ 109,00	33 mm	50 mm	85 mm
F002/34L	€ 112,00	34 mm	50 mm	85 mm
F002/35L	€ 114,00	35 mm	50 mm	85 mm
F002/36L	€ 118,00	36 mm	50 mm	85 mm
F002/37L	€ 119,00	37 mm	50 mm	85 mm
F002/38L	€ 123,00	38 mm	50 mm	85 mm
F002/39L	€ 126,00	39 mm	50 mm	85 mm

Art.	€	Ø	l	L
F002/40L	€ 127,00	40 mm	50 mm	85 mm
F002/41L	€ 148,00	41 mm	50 mm	85 mm
F002/42L	€ 151,00	42 mm	50 mm	85 mm
F002/43L	€ 154,00	43 mm	50 mm	85 mm
F002/44L	€ 157,00	44 mm	50 mm	85 mm
F002/45L	€ 188,00	45 mm	50 mm	85 mm
F002/46L	€ 190,00	46 mm	50 mm	85 mm
F002/47L	€ 193,00	47 mm	50 mm	85 mm
F002/48L	€ 196,00	48 mm	50 mm	85 mm
F002/49L	€ 200,00	49 mm	50 mm	85 mm
F002/50L	€ 203,00	50 mm	50 mm	85 mm
F002/55L	€ 239,00	55 mm	50 mm	85 mm
F002/60L	€ 276,00	60 mm	50 mm	85 mm

F002/6

€ 238,00

LONG TYPE WELDON SHANK CORE DRILL SET

FOR MAGNETIC DRILLS AND DRILL PRESSES, TO CUT MATERIALS WITH RESISTANCE R= 1200 N/MM2

7 Pcs HSS - Co 5%

Sizes	12 x 62 - 14 x 62 - 16 x 62 - 18 x 62 - 20 x 62 - 22 x 62 mm
Shank	Weldon 19,05 mm



F019-

TCT HOLE CUTTER

WITH LATERAL CHIP AND CENTER DRILL. TO CUT STAINLESS STEEL AND HARD METAL SHEETS, RESISTANCE R= 1300 N/MM²



Art.	€	ø	h	d	L	l	Thread
F019/015	€ 10,50	15 mm	28 mm	10 mm	50 mm	5 mm	-
F019/016	€ 11,30	16 mm	28 mm	10 mm	50 mm	5 mm	-
F019/017	€ 12,00	17 mm	28 mm	10 mm	50 mm	5 mm	-
F019/018	€ 12,80	18 mm	28 mm	10 mm	50 mm	5 mm	-
F019/019	€ 13,50	19 mm	28 mm	10 mm	50 mm	5 mm	-
F019/020	€ 14,30	20 mm	28 mm	10 mm	50 mm	5 mm	-
F019/021	€ 15,00	21 mm	28 mm	10 mm	50 mm	5 mm	-
F019/022	€ 15,80	22 mm	28 mm	10 mm	50 mm	5 mm	M12 x 1,25
F019/023	€ 16,50	23 mm	28 mm	10 mm	50 mm	5 mm	M12 x 1,25
F019/024	€ 17,30	24 mm	28 mm	10 mm	50 mm	5 mm	M12 x 1,25
F019/025	€ 18,00	25 mm	28 mm	10 mm	50 mm	5 mm	M12 x 1,25
F019/026	€ 18,80	26 mm	28 mm	10 mm	50 mm	5 mm	M12 x 1,25
F019/027	€ 19,50	27 mm	28 mm	10 mm	50 mm	5 mm	M12 x 1,25
F019/028	€ 20,30	28 mm	28 mm	10 mm	50 mm	5 mm	M12 x 1,25
F019/029	€ 21,00	29 mm	28 mm	10 mm	50 mm	5 mm	M12 x 1,25
F019/030	€ 21,80	30 mm	28 mm	10 mm	50 mm	5 mm	M12 x 1,25
F019/031	€ 22,50	31 mm	28 mm	10 mm	50 mm	5 mm	M12 x 1,25
F019/032	€ 23,30	32 mm	28 mm	10 mm	50 mm	5 mm	M12 x 1,25
F019/033	€ 24,00	33 mm	28 mm	10 mm	50 mm	5 mm	M12 x 1,25
F019/034	€ 24,80	34 mm	28 mm	10 mm	50 mm	5 mm	M12 x 1,25
F019/035	€ 25,50	35 mm	28 mm	10 mm	50 mm	5 mm	M14 x 1,5
F019/036	€ 26,30	36 mm	28 mm	10 mm	50 mm	5 mm	M14 x 1,5
F019/037	€ 27,00	37 mm	28 mm	10 mm	50 mm	5 mm	M14 x 1,5
F019/038	€ 27,80	38 mm	28 mm	10 mm	50 mm	5 mm	M14 x 1,5
F019/039	€ 28,50	39 mm	28 mm	10 mm	50 mm	5 mm	M14 x 1,5
F019/040	€ 29,30	40 mm	28 mm	10 mm	50 mm	5 mm	M14 x 1,5
F019/041	€ 29,60	41 mm	28 mm	10 mm	50 mm	5 mm	M14 x 1,5

Art.	€	ø	h	d	L	l	Thread
F019/042	€ 30,40	42 mm	28 mm	10 mm	50 mm	5 mm	M14 x 1,5
F019/043	€ 31,10	43 mm	28 mm	10 mm	50 mm	5 mm	M14 x 1,5
F019/044	€ 31,50	44 mm	28 mm	10 mm	50 mm	5 mm	M14 x 1,5
F019/045	€ 32,30	45 mm	28 mm	10 mm	50 mm	5 mm	M14 x 1,5
F019/046	€ 33,00	46 mm	28 mm	10 mm	50 mm	5 mm	M14 x 1,5
F019/047	€ 33,80	47 mm	28 mm	10 mm	50 mm	5 mm	M14 x 1,5
F019/048	€ 34,50	48 mm	28 mm	10 mm	50 mm	5 mm	M14 x 1,5
F019/049	€ 35,30	49 mm	28 mm	10 mm	50 mm	5 mm	M14 x 1,5
F019/050	€ 36,00	50 mm	28 mm	10 mm	50 mm	5 mm	M14 x 1,5
F019/051	€ 36,80	51 mm	28 mm	12 mm	50 mm	5 mm	M16 x 1,5
F019/052	€ 37,50	52 mm	28 mm	12 mm	50 mm	5 mm	M16 x 1,5
F019/053	€ 38,30	53 mm	28 mm	12 mm	50 mm	5 mm	M16 x 1,5
F019/054	€ 39,00	54 mm	28 mm	12 mm	50 mm	5 mm	M16 x 1,5
F019/055	€ 39,80	55 mm	28 mm	12 mm	50 mm	5 mm	M16 x 1,5
F019/056	€ 40,50	56 mm	28 mm	12 mm	50 mm	5 mm	M16 x 1,5
F019/057	€ 41,30	57 mm	28 mm	12 mm	50 mm	5 mm	M16 x 1,5
F019/058	€ 42,00	58 mm	28 mm	12 mm	50 mm	5 mm	M16 x 1,5
F019/059	€ 42,80	59 mm	28 mm	12 mm	50 mm	5 mm	M16 x 1,5
F019/060	€ 43,50	60 mm	28 mm	12 mm	50 mm	5 mm	M16 x 1,5
F019/065	€ 50,30	65 mm	28 mm	12 mm	50 mm	5 mm	M16 x 1,5
F019/070	€ 53,30	70 mm	28 mm	12 mm	50 mm	5 mm	M16 x 1,5
F019/075	€ 57,00	75 mm	28 mm	12 mm	50 mm	5 mm	M16 x 1,5
F019/080	€ 60,80	80 mm	28 mm	12 mm	50 mm	5 mm	M16 x 1,5
F019/085	€ 64,50	85 mm	28 mm	12 mm	50 mm	5 mm	M16 x 1,5
F019/090	€ 69,00	90 mm	28 mm	12 mm	50 mm	5 mm	M16 x 1,5
F019/095	€ 72,80	95 mm	28 mm	12 mm	50 mm	5 mm	M16 x 1,5
F019/100	€ 76,50	100 mm	28 mm	12 mm	50 mm	5 mm	M16 x 1,5

F019/006

€ 83,90

TCT HOLE CUTTER SET

WITH LATERAL CHIP AND CENTER DRILL. TO CUT STAINLESS STEEL AND HARD METAL SHEETS, RESISTANCE R= 1300 N/MM²



6 Pcs HM & C45

Sizes	16 mm, 18 mm, 20 mm, 22 mm, 25 mm, 30 mm
Cutting Depth	5 mm

F019/008

€ 119,00

TCT HOLE CUTTER SET

WITH LATERAL CHIP AND CENTER DRILL. TO CUT STAINLESS STEEL AND HARD METAL SHEETS, RESISTANCE R= 1300 N/MM²



8 Pcs HM & C45

Sizes	16 mm, 18 mm, 20 mm, 22 mm, 25 mm, 30 mm, 32 mm, 35 mm
Cutting Depth	5 mm

F019/005

€ 1,58

CENTER DRILL

HSS



ø	6 mm
L	50 mm

F019/007

€ 0,20

SPRING



F015-

HOLE CUTTER

WITH LATERAL CHIP AND CENTER DRILL. TO CUT STEEL, IRON, ALLUMINIUM ALLOY, RESISTANCE R= 800 N/MM²

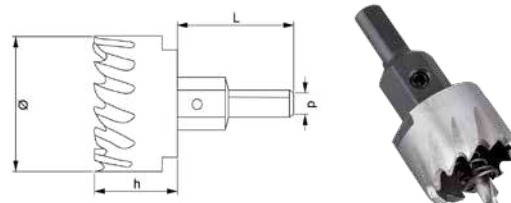

HSS

Art.	€	ø	h	d	L	Thread
F015/012	€ 8,70	12 mm	23 mm	8 mm	56 mm	M10 x 1,25
F015/013	€ 8,70	13 mm	23 mm	8 mm	56 mm	M10 x 1,25
F015/014	€ 9,10	14 mm	23 mm	8 mm	56 mm	M10 x 1,25
F015/015	€ 9,10	15 mm	23 mm	10 mm	56 mm	M12 x 1,25
F015/016	€ 9,10	16 mm	23 mm	10 mm	56 mm	M12 x 1,25
F015/017	€ 9,10	17 mm	23 mm	10 mm	56 mm	M12 x 1,25
F015/018	€ 9,10	18 mm	23 mm	10 mm	56 mm	M12 x 1,25
F015/019	€ 9,50	19 mm	23 mm	10 mm	56 mm	M12 x 1,25
F015/020	€ 9,90	20 mm	23 mm	10 mm	56 mm	M12 x 1,25
F015/021	€ 10,30	21 mm	23 mm	10 mm	56 mm	M12 x 1,25
F015/022	€ 10,70	22 mm	23 mm	10 mm	56 mm	M12 x 1,25
F015/023	€ 11,60	23 mm	23 mm	10 mm	56 mm	M12 x 1,25
F015/024	€ 11,90	24 mm	23 mm	10 mm	56 mm	M12 x 1,25
F015/025	€ 12,30	25 mm	23 mm	10 mm	56 mm	M12 x 1,25
F015/026	€ 13,10	26 mm	23 mm	10 mm	56 mm	M12 x 1,25
F015/027	€ 13,50	27 mm	23 mm	10 mm	56 mm	M12 x 1,25
F015/028	€ 13,90	28 mm	23 mm	10 mm	56 mm	M12 x 1,25
F015/029	€ 14,30	29 mm	23 mm	10 mm	56 mm	M12 x 1,25
F015/030	€ 14,60	30 mm	23 mm	10 mm	56 mm	M12 x 1,25
F015/031	€ 15,00	31 mm	23 mm	10 mm	56 mm	M12 x 1,25
F015/032	€ 15,80	32 mm	23 mm	10 mm	56 mm	M12 x 1,25
F015/033	€ 15,80	33 mm	23 mm	10 mm	56 mm	M12 x 1,25
F015/034	€ 16,60	34 mm	23 mm	10 mm	56 mm	M12 x 1,25
F015/035	€ 17,40	35 mm	23 mm	10 mm	56 mm	M14 x 1,5
F015/036	€ 18,20	36 mm	23 mm	10 mm	56 mm	M14 x 1,5
F015/037	€ 18,20	37 mm	23 mm	10 mm	56 mm	M14 x 1,5
F015/038	€ 18,60	38 mm	23 mm	10 mm	56 mm	M14 x 1,5
F015/039	€ 20,20	39 mm	23 mm	10 mm	56 mm	M14 x 1,5
F015/040	€ 20,20	40 mm	23 mm	10 mm	56 mm	M14 x 1,5

Art.	€	ø	h	d	L	Thread
F015/041	€ 20,60	41 mm	23 mm	10 mm	56 mm	M14 x 1,5
F015/042	€ 20,60	42 mm	23 mm	10 mm	56 mm	M14 x 1,5
F015/043	€ 21,40	43 mm	23 mm	10 mm	56 mm	M14 x 1,5
F015/044	€ 21,80	44 mm	23 mm	10 mm	56 mm	M14 x 1,5
F015/045	€ 23,00	45 mm	23 mm	10 mm	56 mm	M14 x 1,5
F015/046	€ 23,00	46 mm	23 mm	10 mm	56 mm	M14 x 1,5
F015/047	€ 23,40	47 mm	23 mm	10 mm	56 mm	M14 x 1,5
F015/048	€ 24,90	48 mm	23 mm	10 mm	56 mm	M14 x 1,5
F015/049	€ 25,30	49 mm	23 mm	10 mm	56 mm	M14 x 1,5
F015/050	€ 25,30	50 mm	23 mm	10 mm	56 mm	M14 x 1,5
F015/051	€ 30,90	51 mm	23 mm	12 mm	56 mm	M16 x 1,5
F015/052	€ 30,90	52 mm	23 mm	12 mm	56 mm	M16 x 1,5
F015/053	€ 31,70	53 mm	23 mm	12 mm	56 mm	M16 x 1,5
F015/054	€ 33,30	54 mm	23 mm	12 mm	56 mm	M16 x 1,5
F015/055	€ 33,30	55 mm	23 mm	12 mm	56 mm	M16 x 1,5
F015/056	€ 34,00	56 mm	23 mm	12 mm	56 mm	M16 x 1,5
F015/057	€ 34,00	57 mm	23 mm	12 mm	56 mm	M16 x 1,5
F015/058	€ 35,60	58 mm	23 mm	12 mm	56 mm	M16 x 1,5
F015/059	€ 37,20	59 mm	23 mm	12 mm	56 mm	M16 x 1,5
F015/060	€ 37,20	60 mm	23 mm	12 mm	56 mm	M16 x 1,5
F015/065	€ 47,50	65 mm	23 mm	12 mm	56 mm	M16 x 1,5
F015/070	€ 50,70	70 mm	23 mm	12 mm	56 mm	M16 x 1,5
F015/075	€ 54,60	75 mm	23 mm	12 mm	56 mm	M16 x 1,5
F015/080	€ 60,20	80 mm	23 mm	12 mm	56 mm	M16 x 1,5
F015/085	€ 68,90	85 mm	23 mm	12 mm	56 mm	M16 x 1,5
F015/090	€ 76,00	90 mm	23 mm	12 mm	56 mm	M16 x 1,5
F015/095	€ 82,30	95 mm	23 mm	12 mm	56 mm	M16 x 1,5
F015/100	€ 87,10	100 mm	23 mm	12 mm	56 mm	M16 x 1,5

F015/006S

€ 83,90

HSS HOLE CUTTER SET

WITH LATERAL CHIP AND CENTER DRILL. TO CUT STEEL, IRON, ALLUMINIUM ALLOY, RESISTANCE R= 800 N/MM²



6 Pcs HSS

Sizes 16 mm, 18 mm, 20 mm, 22 mm, 25 mm, 30 mm

F015/008S

€ 119,00

HSS HOLE CUTTER SET

WITH LATERAL CHIP AND CENTER DRILL. TO CUT STEEL, IRON, ALLUMINIUM ALLOY, RESISTANCE R= 800 N/MM²



8 Pcs HSS

Sizes 16 mm, 18 mm, 20 mm, 22 mm, 25 mm, 30 mm, 32 mm, 35 mm

F015-A

HOLE CUTTERS ARBOR

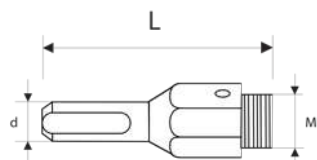

HSS

Art.	€	ø	d	L	Thread
F015/001	€ 2,77	12 - 14 mm	8 mm	56 mm	M10 x 1,25
F015/002	€ 2,77	15-34 mm	10 mm	56 mm	M12 x 1,25
F015/003	€ 3,96	35-50 mm	10 mm	56 mm	M14 x 1,5
F015/004	€ 3,96	51-100 mm	12 mm	60 mm	M16 x 1,5

F015/005

€ 1,58

CENTER DRILL

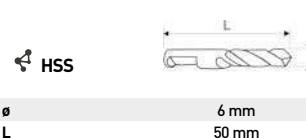

HSS

ø 6 mm
L 50 mm

F015/007

€ 0,20

SPRING



0278-

BIMETAL HOLE SAWS WITH VARIABLE TEETH

SUITABLE FOR CUT OF STEEL, STAINLESS STEEL, CAST IRON, ALUMINIUM, BRONZE, BRASS, COPPER, FIBERGLASS, PLASTIC, PLYWOOD, WOOD



HSS - Co 8% M42

Art.	€	ø	ø inch	Art.	€	ø	ø inch	Art.	€	ø	ø inch	Art.	€	ø	ø inch
0278/014	€ 4,50	14 mm	9/16	0278/033	€ 7,20	33 mm	1-5/16	0278/057	€ 10,70	57 mm	2-1/4	0278/089	€ 17,20	89 mm	3-1/2
0278/016	€ 4,50	16 mm	5/8	0278/035	€ 7,60	35 mm	1-3/8	0278/059	€ 11,00	59 mm	2-5/16	0278/092	€ 17,60	92 mm	3-5/8
0278/017	€ 4,50	17 mm	11/16	0278/037	€ 8,00	37 mm	1-7/16	0278/060	€ 11,00	60 mm	2-3/8	0278/095	€ 18,30	95 mm	3-3/4
0278/019	€ 4,80	19 mm	3/4	0278/038	€ 8,00	38 mm	1-1/2	0278/064	€ 11,90	64 mm	2-1/2	0278/098	€ 18,30	98 mm	3-7/8
0278/020	€ 4,80	20 mm	25/32	0278/040	€ 8,20	40 mm	1-9/16	0278/065	€ 11,90	65 mm	2-9/16	0278/102	€ 18,40	102 mm	4
0278/021	€ 5,10	21 mm	13/16	0278/041	€ 8,30	41 mm	1-5/8	0278/067	€ 12,80	67 mm	2-5/8	0278/105	€ 18,80	105 mm	4-1/8
0278/022	€ 5,10	22 mm	7/8	0278/043	€ 8,30	43 mm	1-11/16	0278/068	€ 12,80	68 mm	2-11/16	0278/108	€ 19,40	108 mm	4-1/4
0278/024	€ 5,40	24 mm	15/16	0278/044	€ 9,10	44 mm	1-3/4	0278/070	€ 12,80	70 mm	2-3/4	0278/111	€ 20,00	111 mm	4-3/8
0278/025	€ 5,40	25 mm	1	0278/046	€ 9,10	46 mm	1-13/16	0278/073	€ 14,10	73 mm	2-7/8	0278/114	€ 20,90	114 mm	4-1/2
0278/027	€ 5,90	27 mm	1-1/16	0278/048	€ 9,30	48 mm	1-7/8	0278/076	€ 14,10	76 mm	3	0278/121	€ 21,80	121 mm	4-3/4
0278/029	€ 5,90	29 mm	1-1/8	0278/051	€ 9,60	51 mm	2	0278/079	€ 14,90	79 mm	3-1/8	0278/127	€ 23,60	127 mm	5
0278/030	€ 7,00	30 mm	1-3/16	0278/052	€ 10,70	52 mm	2-1/16	0278/083	€ 15,80	83 mm	3-1/4	0278/140	€ 31,80	140 mm	5-1/2
0278/032	€ 7,00	32 mm	1-1/4	0278/054	€ 10,70	54 mm	2-1/8	0278/085	€ 15,80	85 mm	3-3/8	0278/152	€ 37,10	152 mm	6

0278/002S

€ 80,80

HOLE SAW SET

ELECTRICIAN SET



9 Pcs HSS - Co 8% M42

Hole saw	22 - 29 mm
Corresponding arbors, adapter, bits	0712/600
Hole saw	35 - 44 mm
Corresponding arbors, adapter, bits	0712/800
Hole saw	51 - 64 mm
Corresponding arbors, adapter, bits	0712/900

0278/005S

€ 53,00

HOLE SAW SET

REPAIRMAN SET



7 Pcs HSS - Co 8% M42

Hole saw	22 - 25 - 29 mm
Corresponding arbors, adapter, bits	0712/600
Hole saw	32 - 38 mm
Corresponding arbors, adapter, bits	0712/900

0278/008S

€ 76,80

HOLE SAW SET

PLUMBER SET



9 Pcs HSS - Co 8% M42

Hole saw	19 - 22 - 29 mm
Corresponding arbors, adapter, bits	0712/600
Hole saw	38 - 44 - 57 mm
Corresponding arbors, adapter, bits	0712/800 - 0712/900

0278/009S

€ 91,00

HOLE SAW SET

INSTALLER SET



13 Pcs HSS - Co 8% M42

Hole saw	19 - 22 - 29 mm
Corresponding arbors, adapter, bits	0712/600 - 0712/900 - 0712/300
Hole saw	35 - 38 - 44 - 51 - 57 - 64 mm
Corresponding arbors, adapter, bits	0712/800



0712-

BI-METAL HSS M3 HOLE SAW VARIABLE TEETH

CAST IRON, ALUMINIUM, BRONZE, BRASS, COPPER, FIBERGLASS, PLASTIC, PLYWOOD, WOOD



HSS M3

Art.	€	ø	ø inch	Art.	€	ø	ø inch	Art.	€	ø	ø inch	Art.	€	ø	ø inch
0712/014	€ 4,13	14 mm	9/16	0712/033	€ 6,00	33 mm	1-5/16	0712/057	€ 9,00	57 mm	2-1/4	0712/089	€ 13,10	89 mm	3-1/2
0712/016	€ 4,13	16 mm	5/8	0712/035	€ 7,70	35 mm	1-3/8	0712/059	€ 9,00	59 mm	2-5/16	0712/092	€ 13,10	92 mm	3-5/8
0712/017	€ 4,13	17 mm	11/16	0712/037	€ 7,70	37 mm	1-7/16	0712/060	€ 9,00	60 mm	2-3/8	0712/095	€ 14,60	95 mm	3-3/4
0712/019	€ 4,13	19 mm	3/4	0712/038	€ 7,70	38 mm	1-1/2	0712/064	€ 10,10	64 mm	2-1/2	0712/098	€ 14,60	98 mm	3-7/8
0712/020	€ 4,13	20 mm	25/32	0712/040	€ 7,70	40 mm	1-9/16	0712/065	€ 10,10	65 mm	2-9/16	0712/102	€ 15,60	102 mm	4
0712/021	€ 4,13	21 mm	13/16	0712/041	€ 7,70	41 mm	1-5/8	0712/067	€ 10,10	67 mm	2-5/8	0712/105	€ 17,00	105 mm	4-1/8
0712/022	€ 5,90	22 mm	7/8	0712/043	€ 7,70	43 mm	1-11/16	0712/068	€ 10,10	68 mm	2-11/16	0712/108	€ 20,90	108 mm	4-1/4
0712/024	€ 5,90	24 mm	15/16	0712/044	€ 7,70	44 mm	1-3/4	0712/070	€ 10,10	70 mm	2-3/4	0712/111	€ 25,90	111 mm	4-3/8
0712/025	€ 5,90	25 mm	1	0712/046	€ 7,70	46 mm	1-13/16	0712/073	€ 11,80	73 mm	2-7/8	0712/114	€ 25,90	114 mm	4-1/2
0712/027	€ 5,90	27 mm	1-1/16	0712/048	€ 7,70	48 mm	1-7/8	0712/076	€ 11,80	76 mm	3	0712/121	€ 25,90	121 mm	4-3/4
0712/029	€ 5,90	29 mm	1-1/8	0712/051	€ 7,70	51 mm	2	0712/079	€ 11,80	79 mm	3-1/8	0712/127	€ 25,90	127 mm	5
0712/030	€ 6,00	30 mm	1-3/16	0712/052	€ 9,00	52 mm	2-1/16	0712/083	€ 13,10	83 mm	3-1/4	0712/140	€ 30,00	140 mm	5-1/2
0712/032	€ 6,00	32 mm	1-1/4	0712/054	€ 9,00	54 mm	2-1/8	0712/085	€ 13,10	85 mm	3-3/8	0712/152	€ 30,00	152 mm	6

0712/002

€ 73,20

**HOLE SAW SET
ELECTRICIAN SET**



9 Pcs HSS M3

Hole saw	22 - 29 mm
Corresponding arbors, adapter, bits	0712/600
Hole saw	35 - 44 mm
Corresponding arbors, adapter, bits	0712/800
Hole saw	51 - 64 mm
Corresponding arbors, adapter, bits	0712/900

0712/005

€ 47,90

**HOLE SAW SET
REPAIRMAN SET**



7 Pcs HSS M3

Hole saw	22 - 25 - 29 mm
Corresponding arbors, adapter, bits	0712/600
Hole saw	32 - 38 mm
Corresponding arbors, adapter, bits	0712/900

0712/008

€ 73,20

**HOLE SAW SET
PLUMBER SET**



9 Pcs HSS M3

Hole saw	19 - 22 - 29 mm
Corresponding arbors, adapter, bits	0712/600
Hole saw	38 - 44 - 57 mm
Corresponding arbors, adapter, bits	0712/800 - 0712/900

0712/009

€ 83,10

**HOLE SAW SET
INSTALLER SET**



13 Pcs HSS M3

Hole saw	19 - 22 - 29 mm
Corresponding arbors, adapter, bits	0712/600 - 0712/900 - 0712/300
Hole saw	35 - 38 - 44 - 51 - 57 - 64 mm
Corresponding arbors, adapter, bits	0712/800

0712/010

€ 157,00

HOLE SAW SET
INDUSTRY SET



21 Pcs HSS M3

Hole saw	19 - 22 - 29 mm
Hole saw	35 - 38 - 44 - 51 - 57 - 64 - 76 - 83 - 92 - 95 - 105 - 114 mm
Corresponding arbors, adapter, bits	0712/600 - 0712/900 - 0712/300
Corresponding arbors, adapter, bits	0712/600 - 0712/900 - 0712/300
Extension	300 mm

0712/900

€ 3,34

ARBOR ADAPTER FOR HOLE SAWS



Gear Reduction ratio	1/2" - 5/8"
For arbor	0712/600 - 0712/700

0712-x00

DRILL BIT

SUITABLE FOR ALL BRANDS



HSS

Art.	€	Shank	For arbor	Length
0712/300	€ 3,34	Ø 6,35 mm	0712/600	105 mm
0712/200	€ 3,34	Ø 6,35 mm	0712/700 - 800	75 mm

0712-x0

HOLE SAW ARBOR WITH DRILL BIT

SUITABLE FOR ALL BRANDS

Art.	€	Shank	Hole saw	Thread
0712/600	€ 6,00	Ø 6,35 mm	Ø 14+30 mm	1/2"
0712/700	€ 6,70	Ø 9,5 mm	Ø 14+30 mm	1/2"
0712/800	€ 10,70	Ø 11 mm	Ø 32+152 mm	5/8"



P049-

MASONRY DRILL

PACKING OF 10* PIECES UNTIL Ø 12 MM,
PACKING OF 5* PIECES FROM Ø 13 MM

HM & C45 DIN 8039

Art.	€	Ø	Total length	Flute length	Shank
P049/03	€ 0,33	3 mm	70 mm	40 mm	Ø 2,5 mm
P049/04	€ 0,35	4 mm	75 mm	40 mm	Ø 3,5 mm
P049/05	€ 0,38	5 mm	85 mm	40 mm	Ø 4,5 mm
P049/06	€ 0,43	6 mm	100 mm	55 mm	Ø 4,5 mm
P049/07	€ 0,62	7 mm	100 mm	55 mm	Ø 6,5 mm
P049/08	€ 0,67	8 mm	120 mm	70 mm	Ø 6,5 mm
P049/09	€ 0,79	9 mm	120 mm	70 mm	Ø 6,5 mm
P049/10	€ 0,89	10 mm	120 mm	70 mm	Ø 7 mm
P049/11	€ 1,50	11 mm	150 mm	90 mm	Ø 7 mm



Art.	€	Ø	Total length	Flute length	Shank
P049/12	€ 1,52	12 mm	150 mm	90 mm	Ø 9 mm
P049/13	€ 1,71	13 mm	150 mm	90 mm	Ø 9 mm
P049/14	€ 1,93	14 mm	150 mm	90 mm	Ø 11 mm
P049/15	€ 2,50	15 mm	150 mm	90 mm	Ø 12 mm
P049/16	€ 2,53	16 mm	150 mm	90 mm	Ø 12 mm
P049/18	€ 4,58	18 mm	160 mm	100 mm	Ø 13 mm
P049/22	€ 6,50	22 mm	160 mm	100 mm	Ø 13 mm
P049/24	€ 7,70	24 mm	160 mm	100 mm	Ø 13 mm

P050-

MASONRY DRILL

PACKING OF 5* PIECES

HM & C45 DIN 8039

Art.	€	Ø	Total length	Flute length	Shank
P050/06	€ 1,62	6 mm	400 mm	240 mm	Ø 4,5 mm
P050/08	€ 1,88	8 mm	400 mm	240 mm	Ø 7 mm
P050/09	€ 2,30	9 mm	400 mm	240 mm	Ø 7 mm
P050/10	€ 2,75	10 mm	400 mm	240 mm	Ø 7 mm
P050/12	€ 3,83	12 mm	400 mm	240 mm	Ø 9 mm



Art.	€	Ø	Total length	Flute length	Shank
P050/14	€ 4,65	14 mm	400 mm	240 mm	Ø 10 mm
P050/16	€ 5,20	16 mm	400 mm	240 mm	Ø 12 mm
P050/18	€ 6,30	18 mm	400 mm	240 mm	Ø 12,5 mm
P050/20	€ 8,00	20 mm	400 mm	240 mm	Ø 12,5 mm

P051-

MASONRY DRILL

PACKING OF 10* PIECES UNTIL Ø 7 MM,
PACKING OF 5* PIECES FROM Ø 8 MM

HM & C45 DIN 8039 135°

Art.	€	Ø	Total length	Flute length	Shank
P051/03	€ 2,22	3 mm	70 mm	40 mm	Ø 2,5 mm
P051/04	€ 2,25	4 mm	75 mm	40 mm	Ø 3,5 mm
P051/05	€ 2,51	5 mm	85 mm	40 mm	Ø 4,5 mm
P051/06	€ 2,75	6 mm	100 mm	55 mm	Ø 5,5 mm
P051/07	€ 2,75	7 mm	100 mm	55 mm	Ø 5,5 mm
P051/08	€ 3,08	8 mm	120 mm	70 mm	Ø 6,5 mm



Art.	€	Ø	Total length	Flute length	Shank
P051/09	€ 3,29	9 mm	120 mm	70 mm	Ø 8 mm
P051/10	€ 3,83	10 mm	120 mm	70 mm	Ø 9 mm
P051/12	€ 4,43	12 mm	150 mm	90 mm	Ø 10 mm
P051/14	€ 5,70	14 mm	150 mm	90 mm	Ø 12 mm
P051/16	€ 6,40	16 mm	150 mm	90 mm	Ø 12 mm

P063-

CARBIDE TIPPED SDS PLUS SHANK TYPE HAMMER TWIST DRILL

PACKING OF 10* PIECES UNTIL Ø 16 MM, PACKING OF
5* PIECES FROM Ø 18 MM

Art.	€	Size
P063/5110	€ 2,57	5 x 110 mm
P063/6110	€ 2,57	6 x 110 mm
P063/6160	€ 2,57	6 x 160 mm
P063/8110	€ 2,57	8 x 110 mm
P063/8160	€ 2,57	8 x 160 mm
P063/9160	€ 2,57	9 x 160 mm

Art.	€	Size
P063/10160	€ 3,09	10 x 160 mm
P063/12160	€ 3,09	12 x 160 mm
P063/12300	€ 3,60	12 x 300 mm
P063/14160	€ 3,60	14 x 160 mm
P063/14300	€ 3,60	14 x 300 mm
P063/15160	€ 4,13	15 x 160 mm



Art.	€	Size
P063/16160	€ 4,13	16 x 160 mm
P063/16300	€ 4,13	16 x 300 mm
P063/16450	€ 7,70	16 x 450 mm
P063/18160	€ 5,70	18 x 160 mm
P063/18300	€ 5,70	18 x 300 mm
P063/18450	€ 8,40	18 x 450 mm

Art.	€	Size
P063/20160	€ 5,70	20 x 160 mm
P063/20450	€ 8,40	20 x 450 mm
P063/22450	€ 10,00	22 x 450 mm
P063/24450	€ 11,30	24 x 450 mm

0332

€ 27,50

CARBIDE TIPPED HAMMER TWIST DRILL AND CHISEL SET

AND CHISEL SET 9 TWIST DRILLS 4 X 110 mm 5 X 110 mm 6 X 110 mm 5 X 160 mm 6 X 160 mm 8 X 160 mm 9 X 160 mm 10 X 160 mm 12 X 160 mm 1 BIT HOLDER 1 FLAT CHISEL 1 POINT CHISEL

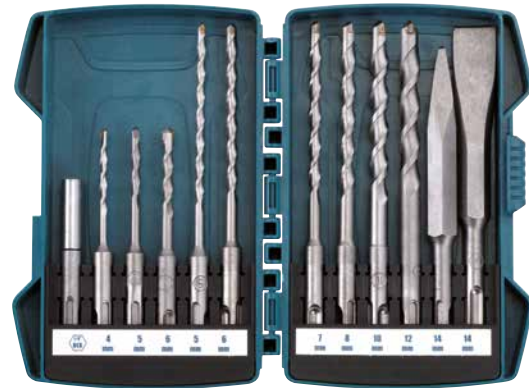

12 Pcs Blister

P076-

CAT 42

CARBIDE TIPPED HOLE CUTTERS FOR MASONRY

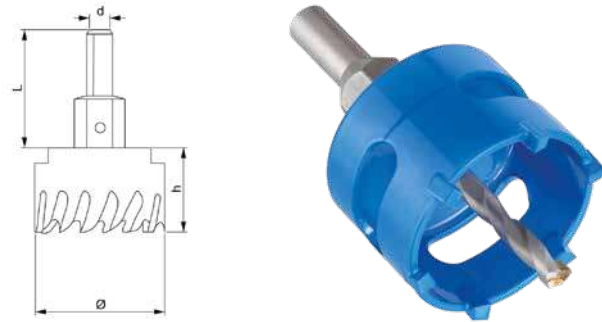

HSS - HM

Art.	€	ø	h	d	Thread	Z	L	Boring bit
P076/016	€ 11,70	16 mm	38 mm	10 mm	M12 x 1.25	2	46 mm	ø6 x 69 mm
P076/022	€ 12,50	22 mm	38 mm	10 mm	M12 x 1.25	3	46 mm	ø6 x 69 mm
P076/025	€ 15,80	25 mm	38 mm	10 mm	M12 x 1.25	3	46 mm	ø6 x 69 mm
P076/027	€ 16,70	27 mm	38 mm	10 mm	M12 x 1.25	4	46 mm	ø6 x 69 mm
P076/030	€ 17,50	30 mm	38 mm	10 mm	M12 x 1.25	4	46 mm	ø6 x 69 mm
P076/035	€ 17,90	35 mm	38 mm	10 mm	M12 x 1.25	4	46 mm	ø6 x 69 mm
P076/038	€ 20,00	38 mm	38 mm	10 mm	M12 x 1.25	4	46 mm	ø6 x 69 mm
P076/040	€ 22,10	40 mm	38 mm	10 mm	M12 x 1.25	5	46 mm	ø6 x 69 mm
P076/045	€ 23,80	45 mm	38 mm	10 mm	M12 x 1.25	5	46 mm	ø6 x 69 mm
P076/050	€ 25,00	50 mm	38 mm	10 mm	M12 x 1.25	6	46 mm	ø6 x 69 mm
P076/055	€ 28,30	55 mm	38 mm	12 mm	M16 x 1.5	6	46 mm	ø8 x 69 mm

Art.	€	ø	h	d	Thread	Z	L	Boring bit
P076/060	€ 30,00	60 mm	38 mm	12 mm	M16 x 1.5	7	46 mm	ø8 x 69 mm
P076/065	€ 33,30	65 mm	38 mm	12 mm	M16 x 1.5	7	46 mm	ø8 x 69 mm
P076/070	€ 41,70	70 mm	38 mm	12 mm	M16 x 1.5	8	46 mm	ø8 x 69 mm
P076/080	€ 47,50	80 mm	38 mm	12 mm	M16 x 1.5	8	46 mm	ø8 x 69 mm
P076/085	€ 53,80	85 mm	38 mm	12 mm	M16 x 1.5	9	46 mm	ø8 x 69 mm
P076/090	€ 62,50	90 mm	38 mm	12 mm	M16 x 1.5	9	46 mm	ø8 x 69 mm
P076/095	€ 63,30	95 mm	38 mm	12 mm	M16 x 1.5	10	46 mm	ø8 x 69 mm
P076/100	€ 67,90	100 mm	38 mm	12 mm	M16 x 1.5	11	46 mm	ø8 x 69 mm
P076/110	€ 80,00	110 mm	38 mm	12 mm	M16 x 1.5	11	46 mm	ø8 x 69 mm
P076/125	€ 88,30	125 mm	38 mm	12 mm	M16 x 1.5	12	46 mm	ø8 x 69 mm
P076/150	€ 113,00	150 mm	38 mm	12 mm	M16 x 1.5	15	46 mm	ø8 x 69 mm

P076/G12

CAT 42

ARBOR FOR HOLE CUTTERS FOR MANSONRY



Art.	€	d	L	Thread	Sizes
P076/G12	€ 2,92	10 mm	46 mm	M12 x 1.25	16-50
P076/G16	€ 3,91	12 mm	46 mm	M16 x 1.5	55-150

P076/G12400

CAT 42

LONG ARBOR FOR HOLE CUTTERS FOR MANSONRY



Art.	€	d	L	Thread	Sizes
P076/G12400	€ 16,70	10 mm	400 mm	M12 x 1.25	16-50
P076/G16400	€ 24,60	12 mm	400 mm	M16 x 1.5	55-150

P076/P12

CAT 42

CARBIDE TIPPED PILOT DRILL FOR HOLE CUTTERS FOR MASONRY



Art.	€	ø	Total length	Sizes
P076/P12	€ 1,25	6 mm	69 mm	16-50
P076/P16	€ 1,67	8 mm	69 mm	55-150

P076/006S

CAT 42 € 112,00

CARBIDE TIPPED HOLE CUTTER SET FOR MASONRY



6 HSS - HM

Sizes 16 mm - 22 mm - 25 mm - 27 mm - 30 mm - 35 mm

P076/008S

CAT 42 € 165,00

CARBIDE TIPPED HOLE CUTTER SET FOR MASONRY



8 HSS - HM

Sizes 16 mm - 22 mm - 25 mm - 27 mm - 30 mm - 35 mm - 40 mm - 45 mm

P031-

CAT 42

DIAMOND DRILL BITS AND CORE DRILLS WITH CONTINUOUS EDGE

FOR HARD MATERIALS SUCH AS GRANITE, PROCELAIN TILES, MARBLE ETC. WET DRILLING, ALTERNATE ROTATION CLOCKWISE AND ANTICLOCKWISE

Art.	€	Size	Hex drive	Total length	Diamond height	Grit
P031/05	€ 12,50	ø5 mm	9,5 mm	56 mm	2 mm	50/60
P031/06	€ 12,90	ø6 mm	9,5 mm	56 mm	2 mm	50/60
P031/07	€ 13,80	ø7 mm	9,5 mm	56 mm	2 mm	50/60
P031/08	€ 14,60	ø8 mm	9,5 mm	56 mm	2 mm	50/60
P031/10	€ 16,70	ø10 mm	9,5 mm	56 mm	2 mm	50/60
P031/12	€ 17,50	ø12 mm	9,5 mm	56 mm	2 mm	50/60
P031/14	€ 20,00	ø14 mm	9,5 mm	56 mm	2 mm	50/60



P031-xL

CAT 42

DIAMOND DRILL BITS AND CORE DRILLS WITH CONTINUOUS EDGE

FOR HARD MATERIALS SUCH AS GRANITE, PROCELAIN TILES, MARBLE ETC. WET DRILLING, ALTERNATE ROTATION CLOCKWISE AND ANTICLOCKWISE

Art.	€	Size	Hex drive	Total length	Cut height	Grit
P031/16	€ 24,20	ø16 mm	12,5 mm	90 mm	5 mm	35/40
P031/18	€ 25,00	ø18 mm	12,5 mm	90 mm	5 mm	35/40
P031/20	€ 28,30	ø20 mm	12,5 mm	90 mm	5 mm	35/40
P031/22	€ 30,80	ø22 mm	12,5 mm	90 mm	5 mm	35/40
P031/25	€ 35,00	ø25 mm	12,5 mm	90 mm	5 mm	35/40
P031/28	€ 37,50	ø28 mm	12,5 mm	90 mm	5 mm	35/40
P031/30	€ 41,70	ø30 mm	12,5 mm	90 mm	5 mm	35/40
P031/32	€ 45,00	ø32 mm	12,5 mm	90 mm	5 mm	35/40
P031/35	€ 48,30	ø35 mm	12,5 mm	90 mm	5 mm	35/40
P031/40	€ 55,00	ø40 mm	12,5 mm	90 mm	5 mm	35/40
P031/45	€ 61,70	ø45 mm	12,5 mm	90 mm	5 mm	35/40
P031/50	€ 69,20	ø50 mm	12,5 mm	90 mm	5 mm	35/40
P031/60	€ 85,80	ø60 mm	12,5 mm	90 mm	5 mm	35/40
P031/65	€ 93,30	ø65 mm	12,5 mm	90 mm	5 mm	35/40
P031/67	€ 101,00	ø67 mm	12,5 mm	90 mm	5 mm	35/40
P031/70	€ 110,00	ø70 mm	12,5 mm	90 mm	5 mm	35/40
P031/80	€ 127,00	ø80 mm	12,5 mm	90 mm	5 mm	35/40



P031/06P

CAT 42 € 2,29

PILOT TIP



Diameter	ø 6 mm
Length	100 mm
Shank	ø 5 mm

P031/03S

CAT 42 € 41,70

DIAMOND DRILL BIT AND CORE DRILL WITH CONTINUOUS EDGE SET

FOR HARD MATERIALS SUCH AS GRANITE, PROCELAIN TILES, MARBLE ETC. WET DRILLING, ALTERNATE ROTATION CLOCKWISE AND ANTICLOCKWISE



3

Sizes	6 mm - 8 mm - 10 mm
Hex drive	9,5 mm
Total length	56 mm
Diamond height	2 mm
Grit	50/60

P031/05S

CAT 42 € 66,70

DIAMOND DRILL BIT AND CORE DRILL WITH CONTINUOUS EDGE SET

FOR HARD MATERIALS SUCH AS GRANITE, PORCELAIN TILES, MARBLE ETC. WET DRILLING, ALTERNATE ROTATION CLOCKWISE AND ANTICLOCKWISE



5

Sizes	5 mm - 6 mm - 8 mm - 10 mm
Hex drive	9.5 mm
Total length	56 mm
Diamond height	2 mm
Grit	50/60

P031/06S

CAT 42 € 200,00

DIAMOND DRILL BIT AND CORE DRILL WITH CONTINUOUS EDGE SET

FOR HARD MATERIALS SUCH AS GRANITE, PORCELAIN TILES, MARBLE ETC. WET DRILLING, ALTERNATE ROTATION CLOCKWISE AND ANTICLOCKWISE



6

Sizes	16 mm - 22 mm - 25 mm - 28 mm - 30 mm - 35 mm
Hex drive	9.5 mm
Total length	56 mm
Diamond height	2 mm
Grit	50/60

P033-

CAT 42

DIAMOND DRILL BITS WITH CONTINUOUS EDGE

FOR DRY CUTTING HARD MATERIAL SUCH AS GRANITE, PORCELAIN TILES, MARBLE ETC. DRY AND WET DRILLING, WITH NATURAL COOLING WAX UNTIL 14MM.

Art.	€	Size	Hex drive	Total length	Diamond height
P033/05	€ 20,80	5 mm	9.5 mm	80 mm	10 mm
P033/06	€ 20,80	6 mm	9.5 mm	80 mm	10 mm
P033/08	€ 20,80	8 mm	9.5 mm	80 mm	10 mm
P033/10	€ 22,50	10 mm	9.5 mm	80 mm	10 mm
P033/12	€ 25,00	12 mm	9.5 mm	80 mm	10 mm
P033/14	€ 26,70	14 mm	12.5 mm	80 mm	10 mm
P033/16	€ 30,80	16 mm	12.5 mm	80 mm	10 mm
P033/18	€ 35,00	18 mm	12.5 mm	80 mm	10 mm
P033/20	€ 39,20	20 mm	12.5 mm	80 mm	10 mm
P033/22	€ 42,50	22 mm	12.5 mm	80 mm	10 mm
P033/25	€ 48,30	25 mm	12.5 mm	80 mm	10 mm



P033/03S

CAT 42 € 58,30

DIAMOND DRILL BIT AND CORE DRILL WITH CONTINUOUS EDGE SET

FOR DRY CUTTING HARD MATERIAL SUCH AS GRANITE, PORCELAIN TILES, MARBLE ETC. DRY AND WET DRILLING, WITH NATURAL COOLING WAX UNTIL 14MM.



3

Sizes	6 mm - 8 mm - 10 mm
Hex drive	9.5 mm
Total length	80 mm
Diamond height	10 mm

P034-

CAT 42

M14 DIAMOND DRILL BITS AND CORE DRILLS WITH CONTINUOUS EDGE

FOR HARD MATERIALS SUCH AS GRANITE, PORCELAIN TILES, MARBLE ETC. FOR DRY AND WET DRILLING, WITH NATURAL COOLANT WAX, GRIT #30÷#50, CLOCKWISE AND ANTICLOCKWISE ALTERNATE ROTATION



Art.	€	Size	Thread	Total length	Diamond height
P034/006	€ 24,60	6 mm	M 14	62 mm	10 mm
P034/008	€ 25,00	8 mm	M 14	62 mm	10 mm
P034/010	€ 25,00	10 mm	M 14	62 mm	10 mm
P034/012	€ 26,70	12 mm	M 14	62 mm	10 mm
P034/014	€ 29,20	14 mm	M 14	62 mm	10 mm
P034/016	€ 29,60	16 mm	M 14	62 mm	15 mm
P034/018	€ 30,00	18 mm	M 14	62 mm	15 mm
P034/020	€ 30,40	20 mm	M 14	60 mm	15 mm
P034/022	€ 30,80	22 mm	M 14	60 mm	15 mm
P034/025	€ 31,30	25 mm	M 14	60 mm	15 mm
P034/028	€ 34,20	28 mm	M 14	60 mm	15 mm
P034/030	€ 36,70	30 mm	M 14	60 mm	15 mm
P034/032	€ 39,20	32 mm	M 14	60 mm	15 mm
P034/035	€ 42,50	35 mm	M 14	60 mm	15 mm
P034/040	€ 49,20	40 mm	M 14	60 mm	15 mm
P034/045	€ 55,00	45 mm	M 14	60 mm	15 mm
P034/050	€ 59,20	50 mm	M 14	60 mm	15 mm
P034/055	€ 66,70	55 mm	M 14	60 mm	15 mm
P034/060	€ 73,30	60 mm	M 14	60 mm	15 mm
P034/065	€ 79,20	65 mm	M 14	60 mm	15 mm
P034/067	€ 81,70	67 mm	M 14	60 mm	15 mm
P034/070	€ 85,80	70 mm	M 14	60 mm	15 mm
P034/080	€ 97,50	80 mm	M 14	60 mm	15 mm
P034/090	€ 107,00	90 mm	M 14	60 mm	15 mm
P034/100	€ 132,00	100 mm	M 14	60 mm	15 mm

P034/05S

CAT 42 € 125,00

M14 DIAMOND DRILL BIT AND CORE DRILL WITH CONTINUOUS EDGE SET

FOR HARD MATERIALS SUCH AS GRANITE, PROCELAIN TILES, MARBLE ETC. FOR DRY AND WET DRILLING, WITH NATURAL COOLANT WAX, GRIT #30-#50, CLOCKWISE AND ANTICLOCKWISE ALTERNATE ROTATION



5

Sizes	6 mm - 8 mm - 10 mm - 12 mm - 14 mm
Thread	M14
Total length	62 mm
Diamond height	10 mm

P034/06S

CAT 42 € 311,00

M14 DIAMOND DRILL BIT AND CORE DRILL WITH CONTINUOUS EDGE SET

FOR HARD MATERIALS SUCH AS GRANITE, PROCELAIN TILES, MARBLE ETC. FOR DRY AND WET DRILLING, GRIT #30-#50, CLOCKWISE AND ANTICLOCKWISE ALTERNATE ROTATION



6

Sizes	22 mm - 35 mm - 40 mm - 45 mm - 50 mm - 67 mm
Thread	M14
Total length	60 mm
Diamond height	15 mm

P035-

CAT 42

DIAMOND DRILL BITS WITH CONTINUOUS EDGE

FOR TILES, CONCRETE AND STRONG BUILDING MATERIALS WET DRILLING, CLOCKWISE AND ANTICLOCKWISE ALTERNATE ROTATION, ROUND SHANK

Art.	€	Size	Shank	Total length	Diamond height
P035/05	€ 6,70	5 mm	Ø 6 mm	65 mm	5 mm
P035/06	€ 6,70	6 mm	Ø 6 mm	65 mm	5 mm
P035/08	€ 6,70	8 mm	Ø 6 mm	65 mm	5 mm
P035/10	€ 6,70	10 mm	Ø 6 mm	65 mm	5 mm
P035/12	€ 7,50	12 mm	Ø 6 mm	65 mm	5 mm
P035/14	€ 8,30	14 mm	Ø 6 mm	65 mm	5 mm



P035/04S

CAT 42 € 25,00

DIAMOND DRILL BIT SET WITH CONTINUOUS EDGE

FOR TILES, CONCRETE AND STRONG BUILDING MATERIALS WET DRILLING, CLOCKWISE AND ANTICLOCKWISE ALTERNATE ROTATION, ROUND SHANK



4

Sizes	5 mm - 6 mm - 8 mm - 10 mm
Shank	Ø 6 mm
Total length	65 mm
Diamond height	5 mm

0529

€ 31,70

1/4" DRIVE DIAMOND CORE DRILL BIT SET

WITH QUICK CHANGE BIT HOLDER, FOR WET DRILLING OF MARBLE, GRANITE, TILES AND GRES



6 Pcs Blister

Drills	5 - 6 - 8 - 10 - 12 mm
Shank	1/4"
Total length	60 mm
Cut length	30 mm
Weight	230 g

D009/5-12

CAT 42 € 23,30

DRILL SUCTION CUP WITH GUIDING HOLES

TO BE USED IN COMBINATION WITH A NEBULIZER FOR WORKING WITH ADDED WATER



Holes	4 mm - 5 mm - 6 mm - 7 mm - 8 mm - 10 mm - 12 mm
-------	--

D009/5-85

CAT 42 € 35,00

DRILL SUCTION CUP WITH ADJUSTABLE HOLE FRAME

TO BE USED IN COMBINATION WITH A NEBULIZER FOR WORKING WITH ADDED WATER



Holes	5 - 85 mm
-------	-----------

P052-

CAT 42

BRAD POINT WOODWORKING DRILLS

WITH GROUND CENTER TIP AND 2 CUTTING EDGES

PACKING OF 5* PIECES UNTIL Ø 8 MM

HSS DIN 7487

Art.	€	Ø	Total length	Flute length
P052/03	€ 0,71	3 mm	61 mm	33 mm
P052/04	€ 0,79	4 mm	75 mm	43 mm
P052/05	€ 0,95	5 mm	86 mm	52 mm
P052/06	€ 1,03	6 mm	93 mm	57 mm
P052/07	€ 1,27	7 mm	109 mm	69 mm
P052/08	€ 1,66	8 mm	117 mm	75 mm
P052/09	€ 1,90	9 mm	125 mm	81 mm
P052/10	€ 2,22	10 mm	133 mm	87 mm
P052/11	€ 2,93	11 mm	142 mm	94 mm



Art.	€	Ø	Total length	Flute length
P052/12	€ 3,64	12 mm	151 mm	101 mm
P052/13	€ 4,20	13 mm	151 mm	101 mm
P052/14	€ 5,20	14 mm	160 mm	108 mm
P052/15	€ 6,20	15 mm	169 mm	114 mm
P052/16	€ 8,60	16 mm	178 mm	120 mm
P052/17	€ 9,90	17 mm	184 mm	125 mm
P052/18	€ 11,50	18 mm	191 mm	130 mm
P052/19	€ 13,10	19 mm	198 mm	135 mm
P052/20	€ 14,30	20 mm	205 mm	140 mm

P052/085

CAT 42 € 11,00

BRAD POINT WOODWORKING DRILLS SET

WITH GROUND CENTER TIP AND 2 CUTTING EDGES



8 Pcs HSS DIN 7487

Size 3 + 10 mm

0238

€ 9,80

HOLE SAW SET FOR WOOD



10 Pcs

Sizes Ø 22 - 29 - 32 - 38 - 44 - 51 - 57 - 67 mm

0463

€ 17,70

TWIST DRILL SET WITH COUNTERSINK FOR WOOD

1/4" HEX SHANK, USEFUL FOR COUNTERSINKING THE WOOD



4 Pcs HSS & C45

Sizes 2 - 2,5 - 3 - 3,5 mm
Shank 1/4"

0799-

MORTISING DRILL SET



6 Pcs C45

Art.	€	Sizes	Revolution	Shank
0799/SXC	€ 55,20	Ø 6 - 8 - 10 - 12 - 14 - 16 mm	L	Ø 16 x 50 mm
0799/DXC	€ 55,20	Ø 6 - 8 - 10 - 12 - 14 - 16 mm	R	Ø 16 x 50 mm

0087

€ 35,60

UNIVERSAL CYLINDER CARBIDE TIPPED BORING BIT



5 Pcs

Boring bit Ø 15 - 20 - 26 - 30 - 35 mm
Shank Ø 8 up to 26 Ø 10 for 30 and 35 mm

0087/35

€ 9,00

UNIVERSAL CYLINDER CARBIDE TIPPED BORING BIT



Boring bit Ø 35 mm
Shank Ø 10 mm

0526

€ 25,30

TWIST DRILL AND COUNTERSINK SET WITH 1/4" HEX SHANK

1/4" HEX SHANK WITH COUNTERSINK FOR WOOD



3 Pcs HSS Blister

Drills 2,75 - 3,25 - 3,5 mm
Shank 1/4"

0524

€ 41,20

1/4" DR. DRILL BIT HOLDER SET

10 PC, MADE OF 45# STEEL



10 Pcs Plastic box

Sizes 3-3.5-4-4.5-5-5.5-6-6.5-8-10 mm
Shank 1/4"



A208B-

MACHINE REAMER

RIGHT CUT LEFT FLUTE MORSE TAPER SHANK

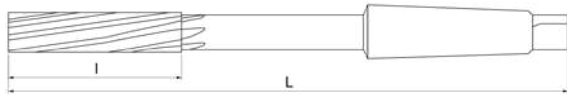

HSS DIN 208/B

Art.	€	øH7	L	I	MT
A208B/05	€ 18,00	5 mm	133 mm	23 mm	1
A208B/06	€ 19,50	6 mm	138 mm	26 mm	1
A208B/07	€ 19,50	7 mm	150 mm	31 mm	1
A208B/08	€ 20,50	8 mm	156 mm	33 mm	1
A208B/09	€ 20,50	9 mm	162 mm	36 mm	1
A208B/10	€ 22,30	10 mm	168 mm	38 mm	1
A208B/11	€ 22,30	11 mm	175 mm	41 mm	1
A208B/12	€ 23,40	12 mm	180 mm	43 mm	1
A208B/13	€ 23,40	13 mm	182 mm	44 mm	1
A208B/14	€ 24,50	14 mm	189 mm	47 mm	1
A208B/15	€ 28,00	15 mm	204 mm	50 mm	2
A208B/16	€ 28,00	16 mm	210 mm	52 mm	2
A208B/17	€ 28,70	17 mm	214 mm	54 mm	2
A208B/18	€ 29,20	18 mm	219 mm	56 mm	2
A208B/19	€ 30,00	19 mm	223 mm	58 mm	2
A208B/20	€ 33,30	20 mm	228 mm	60 mm	2
A208B/21	€ 35,00	21 mm	232 mm	62 mm	2

Art.	€	øH7	L	I	MT
A208B/22	€ 38,30	22 mm	237 mm	64 mm	2
A208B/23	€ 42,10	23 mm	241 mm	66 mm	2
A208B/24	€ 43,70	24 mm	268 mm	68 mm	3
A208B/25	€ 47,90	25 mm	268 mm	68 mm	3
A208B/26	€ 50,30	26 mm	273 mm	70 mm	3
A208B/27	€ 56,10	27 mm	277 mm	71 mm	3
A208B/28	€ 61,10	28 mm	277 mm	71 mm	3
A208B/29	€ 62,70	29 mm	281 mm	73 mm	3
A208B/30	€ 66,80	30 mm	281 mm	73 mm	3
A208B/31	€ 70,10	31 mm	285 mm	75 mm	3
A208B/32	€ 73,40	32 mm	317 mm	77 mm	4
A208B/34	€ 97,50	34 mm	321 mm	78 mm	4
A208B/35	€ 102,00	35 mm	321 mm	78 mm	4
A208B/36	€ 106,00	36 mm	325 mm	79 mm	4
A208B/38	€ 118,00	38 mm	329 mm	81 mm	4
A208B/40	€ 128,00	40 mm	329 mm	81 mm	4

A212-

MACHINE REAMER

HSS RIGHT CUT LEFT FLUTE STRAIGHT SHANK



HSS DIN 212/B

Art.	€	øH7	L	I	d h9	Z
A212/02.00	€ 17,00	2 mm	49 mm	11 mm	2 mm	4
A212/02.50	€ 17,00	2,5 mm	57 mm	14 mm	2,5 mm	4
A212/03.00	€ 17,00	3 mm	61 mm	15 mm	3 mm	4
A212/03.50	€ 17,00	3,5 mm	70 mm	18 mm	3,5 mm	6
A212/04.00	€ 11,40	4 mm	75 mm	19 mm	4 mm	6
A212/04.50	€ 11,40	4,5 mm	80 mm	21 mm	4,5 mm	6
A212/05.00	€ 11,40	5 mm	86 mm	23 mm	5 mm	6
A212/05.50	€ 11,40	5,5 mm	93 mm	26 mm	5,5 mm	6
A212/06.00	€ 11,40	6 mm	93 mm	26 mm	6 mm	6
A212/06.50	€ 14,40	6,5 mm	101 mm	28 mm	6,5 mm	6
A212/07.00	€ 14,40	7 mm	109 mm	31 mm	7 mm	6
A212/07.50	€ 14,40	7,5 mm	109 mm	31 mm	7 mm	6

Art.	€	øH7	L	I	d h9	Z
A212/08.00	€ 14,40	8 mm	117 mm	33 mm	8 mm	6
A212/08.50	€ 17,90	8,5 mm	117 mm	33 mm	8 mm	6
A212/09.00	€ 17,90	9 mm	125 mm	36 mm	9 mm	6
A212/09.50	€ 17,90	9,5 mm	125 mm	36 mm	9 mm	6
A212/10.00	€ 17,90	10 mm	133 mm	38 mm	10 mm	6
A212/11.00	€ 20,50	11 mm	142 mm	41 mm	10 mm	6
A212/12.00	€ 28,00	12 mm	151 mm	44 mm	10 mm	6
A212/13.00	€ 28,00	13 mm	151 mm	44 mm	10 mm	6
A212/14.00	€ 33,80	14 mm	160 mm	47 mm	12 mm	6
A212/15.00	€ 33,80	15 mm	162 mm	50 mm	12 mm	8
A212/16.00	€ 33,80	16 mm	170 mm	52 mm	12 mm	8

L018-

CAT 42

SOLID CAP SCREW COUNTER BORE BEFORE THREAD GRADE

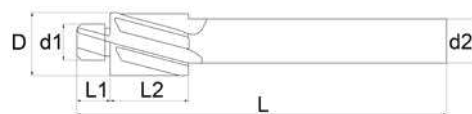

HSS TIN DIN 373

Art.	€	Screw	D	d1	d2	L1	L2	L
L018/03	€ 10,40	M3	6 mm	2,5 mm	5 mm	4 mm	14 mm	71 mm
L018/04	€ 10,40	M4	8 mm	3,3 mm	5 mm	5 mm	14 mm	71 mm
L018/05	€ 10,40	M5	10 mm	4,2 mm	8 mm	6 mm	18 mm	80 mm
L018/06	€ 10,80	M6	11 mm	5,0 mm	8 mm	7 mm	18 mm	80 mm
L018/08	€ 17,50	M8	15 mm	6,8 mm	12,5 mm	9 mm	22 mm	100 mm
L018/10	€ 20,80	M10	18 mm	8,5 mm	12,5 mm	14 mm	22 mm	100 mm
L018/12	€ 22,50	M12	20 mm	10,2 mm	12,5 mm	14 mm	22 mm	100 mm

L018S

CAT 42 € 70,80

SOLID CAP SCREW COUNTER BORE SET BEFORE THREAD



6 HSS TiN DIN 373

Screw M3, M4, M5, M6, M8, M10, M12

L019S

CAT 42 € 70,80

SOLID CAP SCREW COUNTER BORE SET FINE GRADE



6 HSS TiN DIN 373

Screw M3, M4, M5, M6, M8, M10, M12

L019-

CAT 42

SOLID CAP SCREW COUNTER BORE FINE GRADE

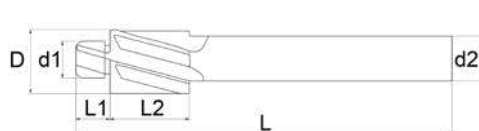

HSS TiN DIN 373

Art.	€	Screw	D	d1	d2	L1	L2	L
L019/03	€ 10,40	M3	6 mm	3,2 mm	5 mm	4 mm	14 mm	71 mm
L019/04	€ 10,40	M4	8 mm	4,3 mm	5 mm	5 mm	14 mm	71 mm
L019/05	€ 10,40	M5	10 mm	5,3 mm	8 mm	6 mm	18 mm	80 mm
L019/06	€ 10,80	M6	11 mm	6,4 mm	8 mm	7 mm	18 mm	80 mm
L019/08	€ 17,50	M8	15 mm	8,4 mm	12,5 mm	9 mm	22 mm	100 mm
L019/10	€ 20,80	M10	18 mm	10,5 mm	12,5 mm	14 mm	22 mm	100 mm
L019/12	€ 22,50	M12	20 mm	13,0 mm	12,5 mm	14 mm	22 mm	100 mm

L020-

COUNTERBORER WITH SOLID PILOT STRAIGHT SHANK MEDIUM TYPE

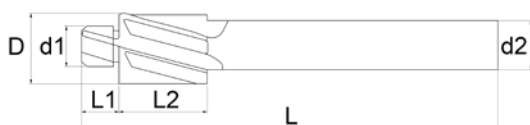

HSS TiN DIN 373

Art.	€	Screw	D	d1	d2	L1	L2	L
L020/03	€ 11,40	M3	6 mm	3,4 mm	5 mm	4 mm	14 mm	71 mm
L020/04	€ 12,30	M4	8 mm	4,5 mm	5 mm	5 mm	14 mm	71 mm
L020/05	€ 13,30	M5	10 mm	5,5 mm	8 mm	6 mm	18 mm	80 mm
L020/06	€ 14,00	M6	11 mm	6,6 mm	8 mm	7 mm	18 mm	80 mm
L020/08	€ 21,30	M8	15 mm	9 mm	12,5 mm	9 mm	22 mm	100 mm
L020/10	€ 24,20	M10	18 mm	11 mm	12,5 mm	14 mm	22 mm	100 mm
L020/12	€ 27,20	M12	20 mm	13,5 mm	12,5 mm	14 mm	22 mm	100 mm

L020

€ 83,10

7-PC COUNTERBORER WITH SOLID PILOT STRAIGHT SHANK



7 Pcs HSS TiN DIN 373

For screws M3 - 4 - 5 - 6 - 8 - 10 - 12

L020S

CAT 42 € 70,80

SOLID CAP SCREW COUNTER BORE SET MEDIUM GRADE



6 HSS TiN DIN 373

Screw M3, M4, M5, M6, M8, M10, M12

C003-

DISC TYPE GEAR SHAPER CUTTER

HOLE 44,45 mm 20° ANGLE PRESSURE CLASS A



HSS TIN DIN 1825

Art.	€	Module	ø max	ø d0	Height b1	Teeth
C003/1	€ 276,00	1,00	102 mm	100 mm	16 mm	100
C003/1.25	€ 276,00	1,25	105 mm	100 mm	16 mm	80
C003/1.50	€ 300,00	1,50	107 mm	102 mm	18 mm	68
C003/1.75	€ 324,00	1,75	107,4 mm	101,5 mm	20 mm	58
C003/2	€ 324,00	2,00	107,31 mm	100 mm	20 mm	50
C003/2.25	€ 324,00	2,25	109,29 mm	101,25 mm	20 mm	45
C003/2.50	€ 371,00	2,50	108,46 mm	100 mm	20 mm	40
C003/2.75	€ 371,00	2,75	108,36 mm	99 mm	24 mm	36
C003/3	€ 371,00	3,00	111,82 mm	99 mm	24 mm	33
C003/3.25	€ 407,00	3,25	110,99 mm	99 mm	24 mm	31
C003/3.50	€ 407,00	3,50	108,72 mm	101,5 mm	24 mm	29

Art.	€	Module	ø max	ø d0	Height b1	Teeth
C003/3.75	€ 407,00	3,75	112,35 mm	101,5 mm	24 mm	27
C003/4	€ 407,00	4,00	111,75 mm	100 mm	24 mm	25
C003/4.25	€ 433,00	4,25	114,12 mm	102 mm	24 mm	24
C003/4.50	€ 433,00	4,50	111,65 mm	99 mm	24 mm	22
C003/5	€ 441,00	5,00	114,05 mm	100 mm	24 mm	20
C003/5.50	€ 468,00	5,50	119,96 mm	99 mm	24 mm	18
C003/6	€ 468,00	6,00	118,86 mm	102 mm	24 mm	17
C003/6.50	€ 587,00	6,50	122,5 mm	112 mm	24 mm	16
C003/7	€ 683,00	7,00	127 mm	105 mm	24 mm	15
C003/8	€ 767,00	8,00	135 mm	112 mm	24 mm	14
C003/10	€ 1050,00	10,00	168 mm	140 mm	24 mm	14

C001-

GEAR HOB 20° PRESSURE ANGLE

GROUND PROFILE CLASS A



HSS TIN DIN 8002/B

Art.	€	Module	Diameter ø	Length	Hole
C001/1	€ 305,00	1,00	50 mm	31 mm	22 mm
C001/1.25	€ 305,00	1,25	50 mm	31 mm	22 mm
C001/1.50	€ 305,00	1,50	53 mm	50 mm	22 mm
C001/1.75	€ 305,00	1,75	56 mm	38 mm	22 mm
C001/2	€ 314,00	2,00	63 mm	46 mm	27 mm
C001/2.25	€ 363,00	2,25	70 mm	56 mm	27 mm
C001/2.50	€ 363,00	2,50	71 mm	63 mm	27 mm
C001/2.75	€ 363,00	2,75	70 mm	56 mm	27 mm
C001/3	€ 441,00	3,00	80 mm	71 mm	32 mm
C001/3.25	€ 515,00	3,25	80 mm	69 mm	32 mm
C001/3.50	€ 536,00	3,50	80 mm	71 mm	32 mm
C001/3.75	€ 614,00	3,75	90 mm	78 mm	32 mm
C001/4	€ 614,00	4,00	90 mm	78 mm	32 mm

Art.	€	Module	Diameter ø	Length	Hole
C001/4.25	€ 669,00	4,25	90 mm	78 mm	32 mm
C001/4.50	€ 669,00	4,50	90 mm	78 mm	32 mm
C001/5	€ 669,00	5,00	100 mm	88 mm	32 mm
C001/5.50	€ 669,00	5,50	100 mm	88 mm	32 mm
C001/6	€ 887,00	6,00	110 mm	108 mm	40 mm
C001/6.50	€ 934,00	6,50	110 mm	109 mm	40 mm
C001/7	€ 934,00	7,00	110 mm	110 mm	40 mm
C001/8	€ 1470,00	8,00	125 mm	130 mm	40 mm
C001/9	€ 1680,00	9,00	125 mm	140 mm	40 mm
C001/10	€ 2270,00	10,00	140 mm	160 mm	40 mm
C001/12	€ 3250,00	12,00	170 mm	195 mm	50 mm
C001/13	€ 3420,00	13,00	180 mm	210 mm	50 mm

F001/10

€ 192,00

SET STRAIGHT SHANK MULTIFLUTE ROUGHING END MILLS

REGULAR LENGTH, CENTER CUTTING, WELDON SHANK, FINE PITCH



10 Pcs HSS TIN DIN 844/B

Mill	ø 6 8 10 12 14 16 18 20 22 25 mm
Shank	ø 6 10 10 12 12 16 16 20 20 25 mm

F001/20

€ 192,00

SET TWO AND FOUR FLUTE STRAIGHT SHANK END MILLS

REGULAR LENGTH, WELDON SHANK, CENTER CUTTING

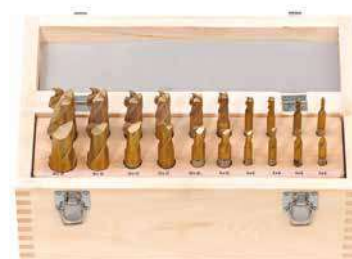

20 Pcs HSS TIN DIN 327/D & DIN 844/B

2 Flute mill	ø 3 - 4 - 5 - 6 - 8 - 10 - 12 - 14 - 18 - 20 mm
Shank	ø 6 - 6 - 6 - 6 - 10 - 10 - 12 - 12 - 16 - 20 mm
4 Flute mill	ø 3 - 4 - 5 - 6 - 8 - 10 - 12 - 14 - 18 - 20 mm
Shank	ø 6 - 6 - 6 - 6 - 10 - 10 - 12 - 12 - 16 - 20 mm

F005-

2 FLUTE STRAIGHT SHANK END MILL

REGULAR LENGTH WELDON SHANK CENTER CUTTING



HSS TIN DIN 327/D

Art.	€	D	d	l	Z	L
F005/03	€ 6,30	3 mm	6 mm	5 mm	2	49 mm
F005/04	€ 6,60	4 mm	6 mm	7 mm	2	51 mm
F005/05	€ 7,40	5 mm	6 mm	8 mm	2	52 mm
F005/06	€ 7,60	6 mm	6 mm	8 mm	2	52 mm
F005/08	€ 9,10	8 mm	10 mm	11 mm	2	61 mm
F005/10	€ 9,20	10 mm	10 mm	13 mm	2	63 mm
F005/12	€ 10,70	12 mm	12 mm	16 mm	2	73 mm

Art.	€	D	d	l	Z	L
F005/14	€ 14,30	14 mm	12 mm	16 mm	2	73 mm
F005/16	€ 21,20	16 mm	16 mm	19 mm	2	79 mm
F005/18	€ 22,10	18 mm	16 mm	19 mm	2	79 mm
F005/20	€ 29,90	20 mm	20 mm	22 mm	2	88 mm
F005/22	€ 37,10	22 mm	20 mm	22 mm	2	88 mm
F005/24	€ 42,00	24 mm	20 mm	26 mm	2	92 mm
F005/25	€ 45,50	25 mm	20 mm	26 mm	2	92 mm

F006-

4 FLUTE STRAIGHT SHANK END MILL

REGULAR LENGTH WELDON SHANK CENTER CUTTING



HSS TIN DIN 844

Art.	€	D	d	l	Z	L
F006/03	€ 6,60	3 mm	6 mm	8 mm	4	52 mm
F006/04	€ 6,60	4 mm	6 mm	11 mm	4	55 mm
F006/05	€ 7,50	5 mm	6 mm	13 mm	4	57 mm
F006/06	€ 7,60	6 mm	6 mm	13 mm	4	57 mm
F006/08	€ 9,50	8 mm	10 mm	19 mm	4	69 mm
F006/10	€ 10,00	10 mm	10 mm	22 mm	4	72 mm

Art.	€	D	d	l	Z	L
F006/12	€ 13,00	12 mm	12 mm	26 mm	4	83 mm
F006/14	€ 13,00	14 mm	12 mm	26 mm	4	83 mm
F006/16	€ 19,00	16 mm	16 mm	32 mm	4	92 mm
F006/18	€ 19,20	18 mm	16 mm	32 mm	4	92 mm
F006/20	€ 26,90	20 mm	20 mm	38 mm	4	104 mm

F007-

4 FLUTE STRAIGHT SHANK ROUGHING END MILL

REGULAR LENGTH WELDON SHANK CENTER CUTTING

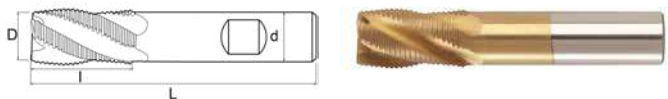

HSS TIN DIN 844/B

Art.	€	D	d	l	Z	L
F007/06	€ 10,70	6 mm	6 mm	13 mm	4	57 mm
F007/07	€ 10,70	7 mm	10 mm	16 mm	4	66 mm
F007/08	€ 11,80	8 mm	10 mm	19 mm	4	69 mm
F007/09	€ 13,70	9 mm	10 mm	19 mm	4	69 mm
F007/10	€ 13,70	10 mm	10 mm	22 mm	4	72 mm
F007/11	€ 13,70	11 mm	12 mm	22 mm	4	76 mm
F007/12	€ 13,70	12 mm	12 mm	26 mm	4	83 mm
F007/13	€ 14,70	13 mm	12 mm	26 mm	4	83 mm

Art.	€	D	d	l	Z	L
F007/14	€ 14,70	14 mm	12 mm	26 mm	4	83 mm
F007/15	€ 18,60	15 mm	12 mm	26 mm	4	83 mm
F007/16	€ 18,60	16 mm	16 mm	32 mm	4	92 mm
F007/18	€ 25,50	18 mm	16 mm	32 mm	4	92 mm
F007/20	€ 34,60	20 mm	20 mm	38 mm	4	104 mm
F007/22	€ 39,70	22 mm	20 mm	38 mm	4	104 mm
F007/25	€ 43,90	25 mm	25 mm	45 mm	4	121 mm

A014-

TAPER DRILL

WITH CILINDRICAL SHANK



HSS M2 TIN

Art.	€	∅	Total length
A014/03-14	€ 10,50	3 - 14 mm	58 mm
A014/06-20	€ 18,20	6 - 20 mm	63 mm
A014/16-30	€ 32,50	16 - 30,5 mm	72 mm
A014/26-40	€ 60,20	26 - 40 mm	86 mm
A014/36-50	€ 80,80	36 - 50 mm	89 mm
A014/40-61	€ 135,00	40 - 61 mm	94 mm
A014/03-31	€ 38,00	3 - 31 mm	104 mm
A014/03-22	€ 22,60	3 - 22,5 mm	76 mm

A014/06-20E

€ 19,00

TAPER DRILL

WITH HEX SHANK



HSS M2 TIN

∅	6 - 20 mm
Total length	63 mm
Shank dimensions	1/4" HEX x 20 mm

A014/03-30S

€ 68,50

TAPER DRILLS SET
WITH CILINDRICAL SHANK



3 Pcs HSS M2 TiN

Sizes 3-14 - 6-20 - 16-30,5 mm

F430

€ 62,70

STEPPED CUTTER SET



3 Pcs HSS TiN

Shank 6 - 8 - 10 mm
Ø 4 ÷ 12 - 6 ÷ 20 - 6 ÷ 30 mm

F639

€ 66,20

STEPPED CUTTER



HSS TiN

Shank 10 mm
Ø 6 ÷ 39 [6-9-12-15-18-21-24-27-30-33-36-39] mm

F23x

STEPPED CUTTER
WITH INTERCHANGEABLE POINT



HSS TiN

Art.	€	Shank	Ø
F232	€ 61,00	10 mm	2,5 ÷ 32 [2,5-6,3-11,2-14,5-18,2-22,3-27,9-32] mm
F238	€ 65,30	10 mm	2,5 ÷ 38 [2,5-6,3-13-16-19-21-23-26-29-32-35-38] mm

F025

€ 5,50

SPARE PART POINT
SUITABLE WITH F232 F238



Shank 4 mm
Spare part point Ø 2,5 mm

S0x

90° THREE FLUTES COUNTERSINK

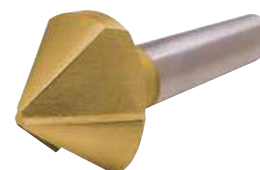

HSS TiN DIN 335/C

Art.	€	Ø max	Screws M	Shank
S006	€ 8,60	6,3 mm	3	Ø 5 mm
S010	€ 10,10	10,4 mm	5	Ø 6 mm
S012	€ 11,60	12,4 mm	6	Ø 8 mm
S016	€ 15,10	16,5 mm	8	Ø 10 mm
S020	€ 18,40	20,5 mm	10	Ø 10 mm
S025	€ 22,10	25 mm	12	Ø 10 mm
S028	€ 27,90	28 mm	14	Ø 12 mm
S031	€ 29,90	31 mm	16	Ø 12 mm
S040	€ 50,50	40 mm	--	Ø 15 mm



S001

€ 78,40

90° THREE FLUTE COUNTERSINK SET



5 Pcs HSS TiN DIN335/C

Ø max 8 - 10 - 12,4 - 16,5 - 20,5 mm

S026-

COUNTERSINK WITH HEX SHANK

90° 3 FLUTES



HSS M2

Art.	€	Ø	Total length	Shank dimensions
S026/06	€ 7,90	6,3 mm	31 mm	1/4" HEX x 25 mm
S026/08	€ 7,90	8,3 mm	31 mm	1/4" HEX x 25 mm
S026/10	€ 8,70	10,4 mm	34 mm	1/4" HEX x 25 mm
S026/12	€ 9,10	12,4 mm	35 mm	1/4" HEX x 25 mm
S026/16	€ 9,90	16,5 mm	40 mm	1/4" HEX x 25 mm
S026/20	€ 11,50	20,5 mm	41 mm	1/4" HEX x 25 mm

S026/06-20S

€ 50,70

COUNTERSINK SET WITH HEX SHANK

90° 3 FLUTES



6 Pcs HSS M2

Sizes 6,3 - 8,3 - 10,4 - 12,4 - 16,5 - 20,5 mm
Shank dimensions 1/4" HEX x 25 mm

S026/06-20SM

€ 61,80

COUNTERSINK SET WITH HEX SHANK

90° 3 FLUTES, WITH HANDLE AND MAGNETIC EXTENSION



8 Pcs HSS M2

Sizes 6,3 - 8,3 - 10,4 - 12,4 - 16,5 - 20,5 mm
Shank dimensions 1/4" HEX x 25 mm



D020

€ 21,30

DIAMOND MOUNTED POINT SET

FOR HARDNESS METAL, HARD METAL, CERAMIC, TILES, MARBLE, GRANITE



☑ 20 Pcs

Shank	Ø 3 mm
Length	45 mm

D050

€ 41,90

DIAMOND MOUNTED POINT AND DISC SET

FOR HARDNESS METAL, HARD METAL, CERAMIC, TILES, MARBLE, GRANITE



☑ 50 Pcs

Shank	Ø 3 mm
Length	45 mm

0835/15

€ 43,50

CARBIDE TIPPED ROUTER BIT SET

HARD METAL TIPS



☑ 15 Pcs ☞ HM

Shank	Ø 6 mm
-------	--------

0830

€ 188,00

CARBIDE TIPPED ROUTER BIT SET



☑ 35 Pcs ☞ HM

Shank	Ø 6 mm
-------	--------



0718

€ 218,00

CUTTER HEAD SET FOR MACHINE



☑ 27 Pcs ☞ HSS ☞ Blow mold case

Head	Ø 100 x 40h mm
Hole	Ø 30 mm
Knives	26

M312/P

€ 50,10

MACHINE TAP SET FOR THROUGH HOLES WITH REINFORCED SHANK



8 Pcs HSS G DIN 371/B

Size M3 x 0,50 - M4 x 0,70 - M5 x 0,80 - M6 x 1 - M8 x 1,25 - M10 x 1,50 - M12 x 1,75

Tap holder 1

M312/C

€ 54,50

MACHINE TAP SET FOR BLIND HOLES 35° WITH REINFORCED SHANK



8 Pcs HSS G DIN 371/C

Size M3 x 0,50 - M4 x 0,70 - M5 x 0,80 - M6 x 1 - M8 x 1,25 - M10 x 1,50 - M12 x 1,75

Tap holder 1

M015S

CAT 42 € 45,80

SPIRAL POINT TAP AND DRILL SET



15 HSS

Taps M3 x 0,50 mm, M4 x 0,70 mm, M5 x 0,80 mm, M6 x 1,00 mm, M8 x 1,2

Drills Ø2,5 mm, Ø3,3 mm, Ø4,2 mm, Ø5,0 mm, Ø6,8 mm, Ø8,5 mm, Ø10

Tap holder 1

M218

€ 194,00

TUNGSTEN STEEL TAP AND DIE METRIC SET

2 PC HAND TAP SET AND DIE: M2 X 0,40 - M3 X 0,50 - M4 X 0,70 - M5 X 0,80 - M6 X 0,75 - M6 X 1 - M7 X 0,75 - M7 X 1 - M8 X 0,75 - M8 X 1 - M8 X 1,25 - M9 X 0,75 - M9 X 1 - M9 X 1,25 - M10 X 0,75 - M10 X 1 - M10 X 1,25 - M10 X 1,5 - M11 X 0,75 - M11 X 1 - M11 X 1,25 - M11 X 1,5 - M12 X 0,75 - M12 X 1 - M12 X 1,25 - M12 X 1,5 - M12 X 1,75 - M14 X 1 - M14 X 1,25 - M14 X 1,5 - M14 X 2 - M16 X 1 - M16 X 1,5 - M16 X 2 - M18 X 1,5

110 Pcs

Round die-stock 2
Tap holder 2



M100

€ 121,00

TAP AND DIE METRIC SET



45 Pcs Tungsten steel

Round die-stock 1
Tap holder 1
Hand tap and die M6x0,75 - M6x1 - M8x1 - M8x1,25 - M10x1,25 - M10x1,5 - M12x1,5 - M12x1,75 - M14x1,5 - M14x2 - M16x1,5 - M16x2 - M18x1,5 - M18x2,5 - M20x1,5 - M20x2,5 - M22x1,5 - M22x2,5 - M24x1,5 - M24x3

M032

€ 91,00

TAP AND DIE METRIC SET



32 Pcs HSS

Tap holder 1
Screw gauge 1
Round die-stock 25 x 9 mm
Screwdriver 3,5 x 50 mm
Taps 3 Pcs M3x0,5 M4x0,7 M5x0,8 M6x1 M8x1,25 M10x1,5 M12x1,75
Dies M3x0,5 M4x0,7 M5x0,8 M6x1 M8x1,25 M10x1,5 M12x1,75

M101

€ 90,30

ALLOY TOOL STEEL TAPS AND DIE METRIC SET

HAND TAP AND DIE: METRIC M3X0,5 - UNC 1/4 20 - NPT 1/8 27 - UNF 4 40 - METRIC M4X0,7 - UNC 1/4 28 - UNF 6 32 - METRIC M5X0,8 - UNC 5/16 18 - UNF 8 32 - METRIC M6X1 - UNC 5/16 24 - UNF 10 32 - METRIC M7X1 - UNC 3/8 16 - UNF 10 24 - METRIC M8X1,25 - UNC 3/8 24 - UNF 12 24 - METRIC M9X1,25 - UNC 7/16 14 - METRIC M10X1,5 - UNC 7/16 20 - METRIC M10X1 - UNC 1/2 13 - METRIC M12X1,75 - UNC 1/2 20



60 Pcs

M020

€ 25,30

TAP AND DIE SET



20 Pcs Alloy steel

Tap holder	M3 - 12
Round die-stock	25 x 9 mm
Taps	M3x0,5 - M4x0,7 - M5x0,8 - M6x1 - M7x1 - M8x1,25 - M10x1,5 - M12x1,75 - 1/8" NPT27
Dies	M3x0,5 - M4x0,7 - M5x0,8 - M6x1 - M7x1 - M8x1,25 - M10x1,5 - M12x1,75 - 1/8" NPT27

M029

€ 97,40

TAP AND DIE SET

WITH TWIST DRILLS AND RATCHET TAP-DIE HOLDER



27 Pcs Tungsten steel

Ratchet handle	200 mm
Dies adaptor	25 x 9 mm
Taps adaptor	5 - 7,5 mm
Taps	M3x0,5 - M4x0,7 - M5x0,8 - M6x1 - M8x1,25 - M10x1,5 - M12x1,75
Dies	M3x0,5 - M4x0,7 - M5x0,8 - M6x1 - M8x1,25 - M10x1,5 - M12x1,75
Drills	2,5 - 3,3 - 4,2 - 5 - 6,8 - 8,5 - 10,3 mm
Screwdriver	6,5 x 50 mm
Tap holder	
Handle	
Screwdriver	3 x 50 mm

M036

€ 49,10

TAP AND DIE SET

WITH TWIST DRILLS



Tap holder	M3 - 12
Round die-stock	25 x 9 mm
Screwdriver	6,5 x 50 mm
Taps	M3x0,5 - M4x0,7 - M5x0,8 - M6x1 - M7x1 - M8x1,25 - M10x1,5 - M12
Dies	M3x0,5 - M4x0,7 - M5x0,8 - M6x1 - M7x1 - M8x1,25 - M10x1,5 - M12
Drills	2,5 - 3,3 - 4,2 - 5 - 6 - 6,8 - 8,5 - 10,3 mm
Screw gauge	
Tap holder	
Handle	

M030

€ 57,10

TAP AND DIE SET

FROM M1 TO M2.5



30 Pcs HSS

Size	M1 - M1.1 - M1.2 - M1.4 - M1.6 - M1.8 - M2.0 - M2.2 - M2.5
------	--

M001-xV

MACHINE TAPS STRAIGHT FLUTE, SPIRAL POINTED FOR THROUGH HOLES

ISOMETRIC THREAD COARSE PITCH - REINFORCED SHANK - STEAMED



HSS DIN 371/B

Art.	€	Sizes
M001/03V	€ 6,00	M3 x 0,50
M001/04V	€ 6,00	M4 x 0,70
M001/05V	€ 6,70	M5 x 0,80
M001/06V	€ 7,30	M6 x 1
M001/08V	€ 9,20	M8 x 1,25
M001/10V	€ 11,50	M10 x 1,5

M001-x

MACHINE TAPS STRAIGHT FLUTE, SPIRAL POINTED FOR THROUGH HOLES

ISOMETRIC THREAD COARSE PITCH - REINFORCED SHANK



HSS DIN 371/B

Art.	€	Sizes
M001/3	€ 4,83	M3 x 0,50
M001/4	€ 4,83	M4 x 0,70
M001/5	€ 5,90	M5 x 0,80
M001/6	€ 6,30	M6 x 1
M001/8	€ 7,70	M8 x 1,25
M001/10	€ 9,80	M10 x 1,5

M002-

MACHINE TAPS STRAIGHT FLUTE SPIRAL POINTED FOR THROUGH HOLES

ISOMETRIC THREAD COARSE PITCH



HSS DIN 376/B

Art.	€	Sizes
M002/12	€ 10,70	M12 x 1,75
M002/14	€ 13,80	M14 x 2
M002/16	€ 15,40	M16 x 2
M002/18	€ 23,80	M18 x 2,5
M002/20	€ 28,30	M20 x 2,5
M002/22	€ 39,60	M22 x 2,5
M002/24	€ 43,50	M24 x 3
M002/27	€ 60,80	M27 x 3
M002/30	€ 70,50	M30 x 3,5

M003-

MACHINE TAPS SPIRAL FLUTE FOR BLIND HOLES 35°

ISOMETRIC THREAD COARSE PITCH - REINFORCED SHANK



HSS DIN 371/C

Art.	€	Sizes
M003/3	€ 4,83	M3 x 0,50
M003/4	€ 4,83	M4 x 0,70
M003/5	€ 5,40	M5 x 0,80
M003/6	€ 6,70	M6 x 1
M003/8	€ 8,20	M8 x 1,25
M003/10	€ 10,10	M10 x 1,5

M002-xV

MACHINE TAPS STRAIGHT FLUTE SPIRAL POINTED FOR THROUGH HOLES

ISOMETRIC THREAD COARSE PITCH - STEAMED



HSS DIN 376/B

Art.	€	Sizes
M002/12V	€ 12,00	M12 x 1,75
M002/14V	€ 15,80	M14 x 2
M002/16V	€ 18,00	M16 x 2
M002/18V	€ 25,50	M18 x 2,5
M002/20V	€ 32,10	M20 x 2,5

M003-xV

MACHINE TAPS SPIRAL FLUTE FOR BLIND HOLES 35°

ISOMETRIC THREAD COARSE PITCH - STEAMED - REINFORCED SHANK



HSS DIN 371/C

Art.	€	Sizes
M003/03V	€ 6,00	M3 x 0,50
M003/04V	€ 6,00	M4 x 0,70
M003/05V	€ 7,20	M5 x 0,80
M003/06V	€ 8,20	M6 x 1
M003/08V	€ 9,40	M8 x 1,25
M003/10V	€ 11,80	M10 x 1,5

M003-xxV

MACHINE TAPS SPIRAL FLUTE FOR BLIND HOLES 35°

ISOMETRIC THREAD COARSE PITCH - STEAMED



HSS DIN 376/C

Art.	€	Sizes
M003/12V	€ 14,00	M12 x 1,75
M003/14V	€ 15,80	M14 x 2
M003/16V	€ 18,80	M16 x 2
M003/18V	€ 25,50	M18 x 2,5
M003/20V	€ 32,10	M20 x 2,5

M003-xxx

MACHINE TAPS SPIRAL FLUTE FOR BLIND HOLES 35°

ISOMETRIC THREAD COARSE PITCH



HSS DIN 376/C

Art.	€	Sizes
M003/12	€ 11,00	M12 x 1,75
M003/14	€ 14,00	M14 x 2
M003/16	€ 16,00	M16x2
M003/18	€ 26,10	M18 x 2,5
M003/20	€ 28,70	M20 x 2,5
M003/22	€ 39,60	M22 x 2,5
M003/24	€ 43,40	M24 x 3
M003/27	€ 60,80	M27 x 3
M003/30	€ 70,50	M30 x 3,5

G003-

RATCHET TAP HOLDER



Art.	€	Tap	Square
G003/1	€ 9,80	M3 ÷ M 8	1,75 ÷ 5,5
G003/2	€ 12,00	M5 ÷ M 12	4 ÷ 8

0890-

3 IN 1 DRILLING - TAPPING - DEBURRING M3 TOOL

WITH 1/4" HEX SHANK



HSS

Art.	€	Tap	Shank	Dimension
0890/M3	€ 5,50	M3 x 0,5	1/4"	52 mm
0890/M4	€ 5,50	M4 x 0,7	1/4"	52 mm
0890/M5	€ 6,30	M5 x 0,8	1/4"	54 mm
0890/M6	€ 6,30	M6 x 1	1/4"	56 mm
0890/M8	€ 7,30	M8 x 1,25	1/4"	58 mm
0890/M10	€ 8,90	M10 x 1,5	1/4"	60 mm

G002-

ADJUSTABLE TAP HOLDER



DIN 1814

Art.	€	Tap	Square
G002/1	€ 5,40	M1 ÷ M10	1,75 ÷ 5,5
G002/2	€ 7,90	M4 ÷ M12	2,4 ÷ 8 mm
G002/3	€ 11,00	M5 ÷ M20	2,7 ÷ 12

0890

€ 43,90

3 IN 1 DRILLING-TAPPING-DEBURRING TOOL AND BIT SET

WITH QUICK CHANGE HOLDER



HSS

Taps 6 Pcs	M3 x 0,5 - M4 x 0,7 - M5 x 0,8 - M6 x 1 - M8 x 1,25 - M10 x 1,5
Shank	1/4"
Phillips	1 - 2
Pozi-driv	1 - 2
Slotted	4 - 5 mm

G001-

ROUND DIE-STOCK



DIN 225

Art.	€	Die dimensions	For dies
G001/20	€ 5,40	20 x 7 mm	M4,5 ÷ M6
G001/25	€ 5,40	25 x 9 mm	M7 ÷ M9
G001/30	€ 6,60	30 x 11 mm	M10 ÷ M11
G001/38	€ 10,10	38 x 14 mm	M12 ÷ M14
G001/45	€ 11,50	45 x 18 mm	M16 ÷ M20
G001/55	€ 12,40	55 x 22 mm	M22 ÷ M24



F121-
METRIC DIE COARSE PITCH



HSS DIN 223

Art.	€	Pitch	Dimensions
F121/03	€ 6,60	3 x 0,5 mm	20 x 5 mm
F121/04	€ 6,60	4 x 0,7 mm	20 x 5 mm
F121/05	€ 7,50	5 x 0,8 mm	20 x 7 mm
F121/06	€ 8,70	6 x 1 mm	20 x 7 mm
F121/08	€ 8,70	8 x 1,25 mm	25 x 9 mm
F121/10	€ 9,90	10 x 1,5 mm	30 x 11 mm
F121/12	€ 11,50	12 x 1,75 mm	38 x 14 mm
F121/14	€ 16,20	14 x 2 mm	38 x 14 mm
F121/16	€ 19,00	16 x 2 mm	45 x 18 mm
F121/18	€ 22,10	18 x 2,5 mm	45 x 18 mm
F121/20	€ 23,40	20 x 2,5 mm	45 x 18 mm

F122-
DIE GAS THREAD



HSS DIN 5158/B

Art.	€	Pitch	Dimensions
F122/1/8	€ 8,60	G1/8-28	30 x 11 mm
F122/1/4	€ 15,00	G1/4-19	38 x 10 mm
F122/3/8	€ 18,60	G3/8-19	45 x 14 mm
F122/1/2	€ 20,00	G1/2-14	45 x 14 mm
F122/5/8	€ 35,80	G5/8-14	55 x 16 mm
F122/3/4	€ 39,30	G3/4-14	55 x 16 mm
F122/7/8	€ 43,50	G7/8-14	65 x 18 mm
F122/1	€ 43,90	G1-11	65 x 18 mm

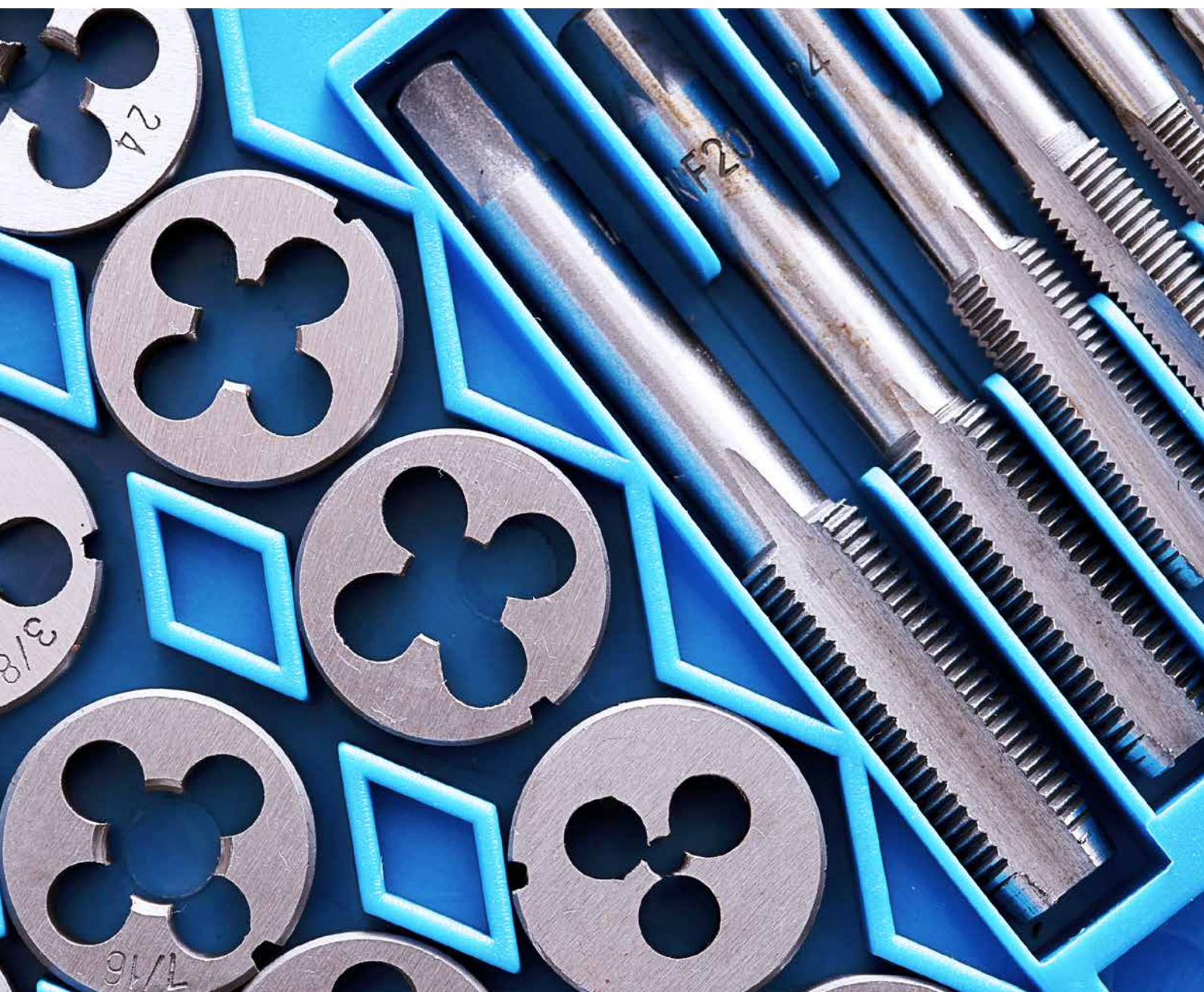

E010

€ 112,00

STAINLESS STEEL THREAD REPAIR INSERT SET M5 - M12

130 Pcs HSS & INOX

Set composition	
"T" handle	5 Pcs /5 Pcs
Thread	M5=25 M6=25 M8=25 M10=25 M12=10
Taps	xM5=1 xM6=1 xM8=1 xM10=1 xM12=1
Drills	5,2=1 6,3=1 8,3=1 10,4=1 12,4=1 mm
Weight	2,5 kg



E010B

CAT 42 € 145,00

METRIC THREAD REPAIR F-COIL SET

125 HSS & INOX

Sizes	M6 - M14 mm
STI Taps	M6 x 1.0 - M8 x 1.25 - M10 x 1.5 - M12 x 1.75 - M14 x 1.25
Drills	6.3 mm - 8.3 mm - 10.4 mm - 12.4 mm
Wire-thread inserts	M6=25 M8=25 M10=20 M12=15 M14=25
Inserting tool	5 Pcs
Tang break tool	5 Pcs



E010E

CAT 42 € 97,40

METRIC THREAD REPAIR F-COIL SET

130 HSS & INOX

Sizes	M5 - M12 mm
Taps	M5 x 0.8 - M6 x 1.0 - M8 x 1.25 - M10 x 1.5 - M12 x 1.75
Drills	5.2 mm - 6.3 mm - 8.3 mm - 10.4 mm - 12.4 mm
Wire-thread inserts	M5=25 M6=25 M8=25 M10=25 M12=10
Inserting tool	5 Pcs
Tang break tool	5 Pcs



E010-

CAT 42

STAINLESS STEEL THREAD REPAIR INSERT SET

HSS & INOX

Art.	€	Thread insert	Drill	Tap	Handle
E010/M05	€ 24,70	M5	5,2 mm	x M5	2
E010/M06	€ 26,80	M6	6,3 mm	x M6	2
E010/M08	€ 29,50	M8	8,3 mm	x M8	2
E010/M10	€ 35,60	M10	10,4 mm	x M10	2
E010/M12	€ 37,70	M12	12,4 mm	x M12	2
E010/M14	€ 45,10	M14 x 1,25	14,4 mm	x M14 x 1,25	2



E011A

CAT 42 € 149,00

METRIC THREAD REPAIR F-COIL SET

130 HSS & INOX

Sizes	M5 - M12 mm
STI Taps	M5 x 0.8 - M6 x 1.0 - M8 x 1.25 - M10 x 1.5 - M12 x 1.75
Drills	5.2 mm - 6.3 mm - 8.3 mm - 10.4 mm - 12.4 mm
Wire-thread inserts	M5=25 M6=25 M8=25 M10=25 M12=10
Inserting tool	5 Pcs
Tang break tool	5 Pcs



E011B

CAT 42 € 175,00

METRIC THREAD REPAIR F-COIL SET

113 HSS & INOX

Sizes	M6 - M14 mm
STI Taps	M6 x 1.0 - M8 x 1.25 - M10 x 1.5 - M12 x 1.75 - M14 x 1.25
Drills	6.3 mm - 8.3 mm - 10.4 mm - 12.4 mm
Wire-thread inserts	M6=25 M8=25 M10=25 M12=10 M14=10
Inserting tool	5 Pcs
Tang break tool	4 Pcs



E011C

CAT 42 € 103,00

METRIC THREAD REPAIR F-COIL SET

87 HSS & INOX

Sizes	M6 - M10 mm
Taps	M6 x 1.0 - M8 x 1.25 - M10 x 1.5
Drills	6.3 mm - 8.3 mm - 10.4 mm
Wire-thread inserts	M6 25 Pcs - M8 25 Pcs - M10 25 Pcs
Inserting tool	3 Pcs
Tang break tool	3 Pcs



E011D

CAT 42 € 185,00

METRIC THREAD REPAIR F-COIL SET

14 mm SIZE SPECIFIC FOR CAR SPARK PLUGS

113 HSS & INOX

Sizes	M6 - M14 mm
Taps	M6 x 1.0 - M8 x 1.25 - M10 x 1.5 - M12 x 1.75 - M14 x 1.25
Drills	6.3 mm - 8.3 mm - 10.4 mm - 12.4 mm
Wire-thread inserts	M6 25 Pcs - M8 25 Pcs - M10 25 Pcs - M12 10 Pcs - M14 10 Pcs
Inserting tool	5 Pcs
Tang break tool	4 Pcs



E011-Mx1

CAT 42

METRIC THREAD REPAIR F-COIL SET

HSS & INOX



Art.	€	Dimensions	Boring bit	Inserting tool	Tang break tool	Wire-thread inserts
E011/M020X040	€ 23,90	M 2 x 0.4	Ø 2.1 mm	E011/U02	E011/A02	20
E011/M025X045	€ 23,90	M 2.5 x 0.45	Ø 2.6 mm	E011/U03	E011/A03	20
E011/M030X050	€ 23,90	M 3 x 0.5	Ø 3.2 mm	E011/U04	E011/A04	20
E011/M035X060	€ 23,90	M 3.5 x 0.6	Ø 3.7 mm	E011/U05	E011/A05	20
E011/M040X070	€ 23,90	M 4 x 0.7	Ø 4.2 mm	E011/U06	E011/A06	20
E011/M050X080	€ 24,70	M 5 x 0.8	Ø 5.2 mm	E011/U08	E011/A08	20
E011/M060X100	€ 26,20	M 6 x 1.0	Ø 6.3 mm	E011/U09	E011/A09	20
E011/M070X100	€ 32,50	M 7 x 1.0	Ø 7.3 mm	E011/U10	E011/A11	20
E011/M080X100	€ 32,50	M 8 x 1.0	Ø 8.3 mm	E011/U11	E011/A11	20
E011/M080X125	€ 32,50	M 8 x 1.25	Ø 8.3 mm	E011/U11	E011/A11	20
E011/M090X100	€ 32,50	M 9 x 1.0	Ø 9.3 mm	E011/U12	E011/A12	10
E011/M090X125	€ 36,50	M 9 x 1.25	Ø 9.3 mm	E011/U12	E011/A12	15
E011/M100X100	€ 34,90	M 10 x 1.0	Ø 10.3 mm	E011/U13	E011/A13	15
E011/M100X125	€ 34,90	M 10 x 1.25	Ø 10.3 mm	E011/U13	E011/A13	15
E011/M100X150	€ 34,90	M 10 x 1.5	Ø 10.4 mm	E011/U13	E011/A13	15
E011/M110X150	€ 38,80	M 11 x 1.5	Ø 11.4 mm	E011/U14	E011/A14	10
E011/M120X100	€ 38,80	M 12 x 1.0	Ø 12.3 mm	E011/U15	E011/A15	10
E011/M120X125	€ 38,80	M 12 x 1.25	Ø 12.3 mm	E011/U15	E011/A15	10
E011/M120X150	€ 38,80	M 12 x 1.5	Ø 12.4 mm	E011/U15	E011/A15	10
E011/M120X175	€ 38,80	M 12 x 1.75	Ø 12.4 mm	E011/U15	E011/A15	10
E011/M140X100	€ 45,10	M 14 x 1.0		E011/U16		10
E011/M140X125	€ 45,10	M 14 x 1.25		E011/U16		10
E011/M140X150	€ 45,10	M 14 x 1.5		E011/U17		10
E011/M140X200	€ 45,10	M 14 x 2.0		E011/U17		10

Art.	€	Dimensions	Boring bit	Inserting tool	Tang break tool	Wire-thread inserts
E011/M160X150	€ 53,00	M 16 x 1.5		E011/U18		10
E011/M160X200	€ 53,00	M 16 x 2.0		E011/U18		10
E011/M180X150	€ 62,50	M 18 x 1.5		E011/U20		5
E011/M180X200	€ 62,50	M 18 x 2.0		E011/U20		5
E011/M180X250	€ 62,50	M 18 x 2.5		E011/U20		5
E011/M200X150	€ 68,00	M 20 x 1.5		E011/U21		5
E011/M200X200	€ 68,00	M 20 x 2.0		E011/U21		5
E011/M200X250	€ 68,00	M 20 x 2.5		E011/U21		5
E011/M220X150	€ 77,40	M 22 x 1.5		E011/U22		5
E011/M220X200	€ 77,40	M 22 x 2.0		E011/U22		5
E011/M220X250	€ 77,40	M 22 x 2.5		E011/U22		5
E011/M240X150	€ 87,70	M 24 x 1.5		E011/U23		5
E011/M240X200	€ 87,70	M 24 x 2.0		E011/U23		5
E011/M240X300	€ 87,70	M 24 x 3.0		E011/U23		5



E011-Mx2

CAT 42

METRIC THREAD REPAIR F-COIL SET

HSS & INOX



Art.	€	Dimensions	Taps	Inserting tool	Wire-thread inserts	Inserts quantity
E011/M260X150	€ 250,00	M 26 x 1.5 mm	E011/M260X150M	E011/UM260X150	E010/M260X150E15	10
E011/M270X150	€ 250,00	M 27 x 1.5 mm	E011/M270X150M	E011/UM270X150	E010/M270X150E15	10
E011/M270X200	€ 250,00	M 27 x 2.0 mm	E011/M270X200M	E011/UM270X200	E010/M270X200E15	10
E011/M270X300	€ 250,00	M 27 x 3.0 mm	E011/M270X300M	E011/UM270X300	E010/M270X300E15	10
E011/M280X150	€ 250,00	M 28 x 1.5 mm	E011/M280X150M	E011/UM280X150	E010/M280X150E15	10
E011/M300X150	€ 297,00	M 30 x 1.5 mm	E011/M300X150M	E011/UM300X150	E010/M300X150E15	10
E011/M300X200	€ 297,00	M 30 x 2.0 mm	E011/M300X200M	E011/UM300X200	E010/M300X200E15	10
E011/M300X350	€ 297,00	M 30 x 3.5 mm	E011/M300X350M	E011/UM300X350	E010/M300X350E15	10
E011/M330X200	€ 306,00	M 33 x 2.0 mm	E011/M330X200M	E011/UM330X200	E010/M330X200E15	10
E011/M330X350	€ 306,00	M 33 x 3.5 mm	E011/M330X350M	E011/UM330X350	E010/M330X350E15	10
E011/M360X150	€ 327,00	M 36 x 1.5 mm	E011/M360X150M	E011/UM360X150	E010/M360X150E15	10
E011/M360X200	€ 327,00	M 36 x 2.0 mm	E011/M360X200M	E011/UM360X200	E010/M360X200E15	10
E011/M360X300	€ 327,00	M 36 x 3.0 mm	E011/M360X300M	E011/UM360X300	E010/M360X300E15	10
E011/M360X400	€ 327,00	M 36 x 4.0 mm	E011/M360X400M	E011/UM360X400	E010/M360X400E15	10
E011/M390X300	€ 415,00	M 39 x 3.0 mm	E011/M390X300M	E011/UM390X300	E010/M390X300E15	10
E011/M390X400	€ 476,00	M 39 x 4.0 mm	E011/M390X400M	E011/UM390X400	E010/M390X400E15	10
E011/M400X300	€ 476,00	M 40 x 3.0 mm	E011/M400X300M	E011/UM400X300	E010/M400X300E15	10
E011/M420X300	€ 476,00	M 42 x 3.0 mm	E011/M420X300M	E011/UM420X300	E010/M420X300E15	10
E011/M420X450	€ 638,00	M 42 x 4.5 mm	E011/M420X450M	E011/UM420X450	E010/M420X450E15	10
E011/M450X300	€ 577,00	M 45 x 3.0 mm	E011/M450X300M	E011/UM450X300	E010/M450X300E15	10
E011/M450X450	€ 658,00	M 45 x 4.5 mm	E011/M450X450M	E011/UM450X450	E010/M450X450E15	10
E011/M480X300	€ 577,00	M 48 x 3.0 mm	E011/M480X300M	E011/UM480X300	E010/M480X300E15	10
E011/M480X500	€ 805,00	M 48 x 5.0 mm	E011/M480X500M	E011/UM480X500	E010/M480X500E15	10
E011/M500X300	€ 638,00	M 50 x 3.0 mm	E011/M500X300M	E011/UM500X300	E010/M500X300E15	10
E011/M520X300	€ 861,00	M 52 x 3.0 mm	E011/M520X300M	E011/UM520X300	E010/M520X300E15	10
E011/M520X500	€ 1000,00	M 52 x 5.0 mm	E011/M520X500M	E011/UM520X500	E010/M520X500E15	10

E011-MxC

CAT 42

SPARK PLUG METRIC THREAD REPAIR F-COIL SET

HSS & INOX

Art.	€	D	Inserting tool	Wire-thread inserts
E011/M060X100C	€ 37,90	M 6 x 1.0 mm	E011/U09	10
E011/M080X125C	€ 37,90	M 8 x 1.25 mm	E011/U11	10
E011/M100X100C	€ 40,20	M 10 x 1.0 mm	E011/U13	10
E011/M100X125C	€ 40,20	M 10 x .25 mm	E011/U13	10
E011/M100X150C	€ 40,20	M 10 x 1.5 mm	E011/U13	10
E011/M120X125C	€ 47,60	M 12 x 1.25 mm	E011/U15	10
E011/M140X125C	€ 54,00	M 14 x 1.25 mm	E011/U17	10

5 x E010/M140X125E084 - 5 x E010/M140X125E124 - 5 x E010/M140X125E164



E010-MxExC

CAT 42

STAINLESS STEEL THREAD REPAIR INSERT



PACKING OF 10* PIECES

Art.	€	Dimensions	H
E010/M140X125E084	€ 0,70	M 14 x 1.25 mm	8.4 mm
E010/M140X125E124	€ 0,62	M 14 x 1.25 mm	12.4 mm
E010/M140X125E164	€ 0,69	M 14 x 1.25 mm	16.4 mm

E011/M140X125MCB

CAT 42 € 33,90

METRIC COMBINED TAP FOR SOLID INSERT



Size	M 16 x 1.25
Hexagon	18 mm
L	70 mm

E011/M140X125B

CAT 42 € 57,50

METRIC SPARK PLUG SOLID THREAD REPAIR SET

STI Taps	M 16 x 1.25
Wire-thread inserts	4 x H 9.5 mm - 4 x H 11.2 mm - 4 x H 12.7 mm - 4 x H 17.5 mm



E011-M140x125Ex

CAT 42

SOLID THREAD INSERT SPARK PLUG SET

PACKING OF 10* PIECES

Art.	€	D	H
E011/M140X125E095	€ 3,39	M 14 x 1.25 mm	9.5 mm
E011/M140X125E112	€ 3,55	M 14 x 1.25 mm	11.2 mm
E011/M140X125E127	€ 3,55	M 14 x 1.25 mm	12.7 mm
E011/M140X125E175	€ 3,78	M 14 x 1.25 mm	17.5 mm



E011/MC

CAT 42 € 168,00

METRIC GLOW PLUG SOLID THREAD REPAIR SET



HSS & INOX

Sizes	8 mm - 10 mm - 12 mm
STI Taps	M8x1 - M10x1 - M10x1.25 - M12x1 - M12x1.25 - M14x1.25

E011/BSW

CAT 42 € 199,00

1/4-1/2 BSW THREAD REPAIR F-COIL SET



115 HSS & INOX

Sizes	BSW 1/4" - 1/2"
STI Taps	1/4"x20-5/16"x18-3/8"x16-7/16"x14-1/2"x12
Drills	6.6 mm - 8.3 mm - 9.9 mm - 11.5 mm - 13.0 mm
Wire-thread inserts	1/4"=25 5/16"=25 3/8"=25 7/16"=10 1/2"=10
Inserting tool	5 Pcs
Tang break tool	5 Pcs

E011-BSWx

CAT 42

BSW THREAD REPAIR F-COIL SET

HSS & INOX

Art.	€	Dimensions	Boring bit	Inserting tool	Tang break tool	Wire-thread inserts
E011/BSW1/8	€ 31,20	1/8" x 40 mm	Ø 3.4 mm	E011/U04	E011/A4	20
E011/BSW3/16	€ 31,20	3/16" x 24 mm	Ø 5.0 mm	E011/U08	E011/A8	20
E011/BSW1/4	€ 28,30	1/4" x 20 mm	Ø 6.7 mm	E011/U09	E011/A9	20
E011/BSW5/16	€ 34,20	5/16" x 18 mm	Ø 8.3 mm	E011/U10	E011/A11	20
E011/BSW3/8	€ 36,30	3/8" x 16 mm	Ø 9.9 mm	E011/U12	E011/A12	15
E011/BSW7/16	€ 40,40	7/16" x 14 mm	Ø 11.5 mm	E011/U14	E011/A14	10
E011/BSW1/2	€ 44,10	1/2" x 12 mm	Ø 13.0 mm	E011/U15	E011/A15	10
E011/BSW9/16	€ 58,20	9/16" x 12 mm	Ø 14.8 mm	E011/U16		10
E011/BSW5/8	€ 58,20	5/8" x 11 mm	Ø 16.50 mm	E011/U18		10
E011/BSW3/4	€ 73,60	3/4" x 10 mm	Ø 20.0 mm	E011/U20		5
E011/BSW7/8	€ 88,90	7/8" x 9 mm	Ø 23.0 mm	E011/U22		5
E011/BSW1	€ 84,90	1" x 8 mm	Ø 26.5 mm	E011/U23		4



E011/BSF

CAT 42 € 199,00

1/4-1/2 BSF THREAD REPAIR F-COIL SET



115 HSS & INOX

Sizes	BSF 1/4" - 1/2"
STI Taps	1/4"x26-5/16"x22-3/8"x20-7/16"x18-1/2"x16
Drills	6.6 mm - 8.3 mm - 9.9 mm - 11.5 mm - 13.0 mm
Wire-thread inserts	1/4"=25 5/16"=25 3/8"=25 7/16"=10 - 1/2"=10
Inserting tool	5 Pcs
Tang break tool	5 Pcs

E011-BSFx
CAT 42
BSF THREAD REPAIR F-COIL SET

Art.	€	Dimensions	Boring bit	Inserting tool	Tang break tool	Wire-thread inserts
E011/BSF3/16	€ 31,20	3/16" x 32 mm	Ø 5.0 mm	E011/U07	E011/A06	20
E011/BSF1/4	€ 28,30	1/4" x 26 mm	Ø 6.6 mm	E011/U09	E011/A09	20
E011/BSF5/16	€ 34,20	5/16" x 22 mm	Ø 8.3 mm	E011/U11	E011/A11	20
E011/BSF3/8	€ 36,30	3/8" x 20 mm	Ø 9.9 mm	E011/U13	E011/A13	15
E011/BSF7/16	€ 40,40	7/16" x 18 mm	Ø 11.5 mm	E011/U14	E011/A14	10
E011/BSF1/2	€ 44,10	1/2" x 16 mm	Ø 13.0 mm	E011/U15	E011/A15	10
E011/BSF9/16	€ 58,20	9/16" x 16 mm	Ø 14.8 mm	E011/U16		10
E011/BSF5/8	€ 58,20	5/8" x 14 mm	Ø 16.4 mm	E011/U18		10
E011/BSF3/4	€ 73,60	3/4" x 12 mm	Ø 19.5 mm	E011/U20		5
E011/BSF7/8	€ 88,90	7/8" x 11 mm	Ø 22.7 mm	E011/U22		5
E011/BSF1	€ 84,90	1" x 10 mm	Ø 26.5 mm	E011/U23		4

E011-BSPx
CAT 42
BSP THREAD REPAIR F-COIL SET

Art.	€	Dimensions	Taps	Wire-thread inserts	Inserts quantity
E011/BSP1/8	€ 63,40	1/8" x 28 mm	E011/BSP1/8M	E010/BSP1/8ME15	10
E011/BSP1/4	€ 71,40	1/4" x 19 mm	E011/BSP1/4M	E010/BSP1/4ME15	10
E011/BSP3/8	€ 78,40	3/8" x 19 mm	E011/BSP3/8M	E010/BSP3/8ME15	10
E011/BSP1/2	€ 100,00	1/2" x 14 mm	E011/BSP1/2M	E010/BSP1/2ME15	10
E011/BSP5/8	€ 204,00	5/8" x 14 mm	E011/BSP5/8M	E010/BSP5/8ME15	10
E011/BSP3/4	€ 204,00	3/4" x 14 mm	E011/BSP3/4M	E010/BSP3/4ME15	10
E011/BSP7/8	€ 283,00	7/8" x 14 mm	E011/BSP7/8M	E010/BSP7/8ME15	10
E011/BSP1	€ 286,00	1" x 11 mm	E011/BSP1M	E010/BSP1ME15	10

E011/UNC
CAT 42 € 199,00
1/4-1/2 UNC THREAD REPAIR F-COIL SET

Sizes	UNC 1/4" - 1/2"
STI Taps	1/4"x20-5/16"x18-3/8"x16-7/16"x14-1/2"x13
Drills	6.7 mm - 8.3 mm - 9.8 mm - 11.5 mm - 13.0 mm
Wire-thread inserts	1/4"=25 5/16"=25 3/8"=25 7/16"=10 1/2"=10
Inserting tool	5 Pcs
Tang break tool	5 Pcs

E011-UNCx
CAT 42
UNC THREAD REPAIR F-COIL SET

Art.	€	Dimensions	Drills	Inserting tool	Tang break tool	Wire-thread inserts
E011/UNCN02	€ 33,50	2" x 56 mm	Ø 2.4 mm	E011/U02	E011/A02	20
E011/UNCN04	€ 30,40	4" x 40 mm	Ø 3.1 mm	E011/U04	E011/A04	20
E011/UNCN05	€ 30,40	5" x 40 mm	Ø 3.4 mm	E011/U04	E011/A04	20
E011/UNCN06	€ 30,40	6" x 32 mm	Ø 3.8 mm	E011/U05	E011/A05	20
E011/UNCN08	€ 30,40	8" x 32 mm	Ø 4.4 mm	E011/U06	E011/A06	20
E011/UNCN10	€ 30,40	10" x 24 mm	Ø 5.2 mm	E011/U07	E011/A06	20
E011/UNCN12	€ 30,40	12" x 24 mm	Ø 5.8 mm	E011/U08	E011/A08	20
E011/UNC1/4	€ 27,50	1/4" x 20 mm	Ø 6.7 mm	E011/U09	E011/A09	20
E011/UNC5/16	€ 33,40	5/16" x 18 mm	Ø 8.3 mm	E011/U10	E011/A11	20
E011/UNC3/8	€ 35,50	3/8" x 16 mm	Ø 9.9 mm	E011/U06	E011/A06	20
E011/UNC7/16	€ 39,60	7/16" x 14 mm	Ø 11.6 mm	E011/U14	E011/A14	10
E011/UNC1/2	€ 43,40	1/2" x 13 mm	Ø 13.0 mm	E011/U15	E011/A15	10
E011/UNC9/16	€ 57,40	9/16" x 12 mm	Ø 14.8 mm	E011/U16		10
E011/UNC5/8	€ 57,40	5/8" x 11 mm	Ø 16.5 mm	E011/U18		10
E011/UNC3/4	€ 72,80	3/4" x 10 mm	Ø 19.75 mm	E011/U20		5
E011/UNC7/8	€ 88,10	7/8" x 9 mm	Ø 23.0 mm	E011/U22		5
E011/UNC1	€ 84,10	1" x 8 mm	Ø 26.25 mm	E011/U23		4



E011/UNF

CAT 42 € 199,00

1/4-1/2 UNF THREAD REPAIR F-COIL SET

115 HSS & INOX

Sizes	UNF 1/4" - 1/2"
STI Taps	1/4"x28-5/16"x24-3/8"x24-7/16"x20-1/2"x20
Drills	6.7 mm - 8.3 mm - 9.8 mm - 11.5 mm - 13.0 mm
Wire-thread inserts	1/4"=25 5/16"=25 3/8"=25 7/16"=10 - 1/2"=10
Inserting tool	5 Pcs
Tang break tool	5 Pcs



E011-UNFx

CAT 42

UNF THREAD REPAIR F-COIL SET

HSS & INOX

Art.	€	Dimension	Drills	Inserting tool	Tang break tool	Wire-thread inserts
E011/UNFN06	€ 30,40	6" x 40	Ø 3.8 mm	E011/U05	E011/A05	20
E011/UNFN08	€ 30,40	8" x 36	Ø 4.4 mm	E011/U06	E011/A06	20
E011/UNFN10	€ 30,40	10" x 32	Ø 5.1 mm	E011/U08	E011/A08	20
E011/UNF1/4	€ 27,50	1/4" x 28	Ø 6.7 mm	E011/U09	E011/A09	20
E011/UNF5/16	€ 33,40	5/16" x 24	Ø 8.3 mm	E011/U11	E011/A11	20
E011/UNF3/8	€ 35,50	3/8" x 24	Ø 9.8 mm	E011/U13	E011/A13	15
E011/UNF7/16	€ 39,60	7/16" x 20	Ø 11.5 mm	E011/U14	E011/A14	10
E011/UNF1/2	€ 43,40	1/2" x 20	Ø 13.0 mm	E011/U15	E011/A15	10
E011/UNF9/16	€ 57,40	9/16" x 18	Ø 14.8 mm	E011/U16		10
E011/UNF5/8	€ 57,40	5/8" x 18	Ø 16.25 mm	E011/U18		10
E011/UNF3/4	€ 72,80	3/4" x 16	Ø 19.5 mm	E011/U21		5
E011/UNF7/8	€ 88,10	7/8" x 14	Ø 22.75 mm	E011/U22		5
E011/UNF1	€ 84,10	1" x 12	Ø 26.0 mm	E011/U23		4



E010-MxE1

CAT 42

STAINLESS STEEL THREAD REPAIR INSERT H=1XD

PACKING OF 25* PIECES UNTIL M10,
PACKING OF 10* PIECES FROM M11 TO M20,
PACKING OF 5* PIECES FROM M22

Art.	€	D	Art.	€	D	Art.	€	D
E010/M020X040E1	€ 0,59	M 2 x 0.4 mm	E010/M100X125E1	€ 0,29	M 10 x 1.25 mm	E010/M180X150E1	€ 1,19	M 18 x 1.5 mm
E010/M022X045E1	€ 0,59	M 2.2 x 0.45 mm	E010/M100X150E1	€ 0,29	M 10 x 1.5 mm	E010/M180X200E1	€ 1,19	M 18 x 2.0 mm
E010/M025X045E1	€ 0,18	M 2.5 x 0.45 mm	E010/M110X150E1	€ 0,48	M 11 x 1.5 mm	E010/M180X250E1	€ 1,19	M 18 x 2.5 mm
E010/M030X050E1	€ 0,18	M 3 x 0.5 mm	E010/M120X100E1	€ 0,43	M 12 x 1.0 mm	E010/M200X150E1	€ 1,38	M 20 x 1.5 mm
E010/M035X060E1	€ 0,20	M 3.5 x 0.6 mm	E010/M120X125E1	€ 0,43	M 12 x 1.25 mm	E010/M200X200E1	€ 1,38	M 20 x 2.0 mm
E010/M040X070E1	€ 0,18	M 4 x 0.7 mm	E010/M120X150E1	€ 0,43	M 12 x 1.5 mm	E010/M200X250E1	€ 1,38	M 20 x 2.5 mm
E010/M050X080E1	€ 0,20	M 5 x 0.8 mm	E010/M120X175E1	€ 0,43	M 12 x 1.75 mm	E010/M220X150E1	€ 1,50	M 22 x 1.5 mm
E010/M060X100E1	€ 0,22	M 6 x 1.0 mm	E010/M140X100E1	€ 0,73	M 14 x 1.0 mm	E010/M220X200E1	€ 1,50	M 22 x 2.0 mm
E010/M070X100E1	€ 0,24	M 7 x 1.0 mm	E010/M140X125E1	€ 0,60	M 14 x 1.25 mm	E010/M220X250E1	€ 1,50	M 22 x 2.5 mm
E010/M080X100E1	€ 0,27	M 8 x 1.0 mm	E010/M140X150E1	€ 0,60	M 14 x 1.5 mm	E010/M240X150E1	€ 1,88	M 24 x 1.5 mm
E010/M080X125E1	€ 0,23	M 8 x 1.25 mm	E010/M140X200E1	€ 0,60	M 14 x 2.0 mm	E010/M240X200E1	€ 1,88	M 24 x 2.0 mm
E010/M090X125E1	€ 0,32	M 9 x 1.25 mm	E010/M160X150E1	€ 0,82	M 16 x 1.5 mm	E010/M240X300E1	€ 1,88	M 24 x 3.0 mm
E010/M100X100E1	€ 0,29	M 10 x 1.0 mm	E010/M160X200E1	€ 0,82	M 16 x 2.0 mm			

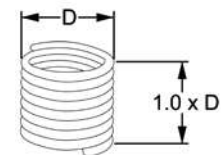

E010-MxE15

CAT 42

STAINLESS STEEL THREAD REPAIR INSERT H=1,5XD

PACKING OF 25* PIECES UNTIL M10,
PACKING OF 10* PIECES FROM M11 TO M20,
PACKING OF 5* PIECES FROM M22

Art.	€	D	Art.	€	D	Art.	€	D
E010/M020X040E15	€ 0,77	M 2 x 0.4 mm	E010/M140X125E15	€ 0,58	M 14 x 1.25 mm	E010/M300X150E15	€ 4,58	M 30 x 1.5 mm
E010/M022X045E15	€ 0,77	M 2.2 x 0.45 mm	E010/M140X150E15	€ 0,58	M 14 x 1.50 mm	E010/M300X200E15	€ 4,58	M 30 x 2.0 mm
E010/M025X045E15	€ 0,19	M 2.5 x 0.45 mm	E010/M140X200E15	€ 0,58	M 14 x 2.0 mm	E010/M300X350E15	€ 4,58	M 30 x 3.5 mm
E010/M030X050E15	€ 0,19	M 3 x 0.5 mm	E010/M160X150E15	€ 0,67	M 16 x 1.5 mm	E010/M330X200E15	€ 5,40	M 33 x 2.0 mm
E010/M035X060E15	€ 0,22	M 3.5 x 0.6 mm	E010/M160X200E15	€ 0,67	M 16 x 2.0 mm	E010/M330X350E15	€ 5,40	M 33 x 3.5 mm
E010/M040X070E15	€ 0,19	M 4 x 0.7 mm	E010/M180X150E15	€ 1,04	M 18 x 1.5 mm	E010/M360X150E15	€ 5,40	M 36 x 1.5 mm
E010/M050X080E15	€ 0,17	M 5 x 0.8 mm	E010/M180X200E15	€ 1,04	M 18 x 2.0 mm	E010/M360X200E15	€ 5,40	M 36 x 2.0 mm
E010/M060X100E15	€ 0,18	M 6 x 1.0 mm	E010/M180X250E15	€ 1,04	M 18 x 2.5 mm	E010/M360X300E15	€ 5,40	M 36 x 3.0 mm
E010/M070X100E15	€ 0,29	M 7 x 1.0 mm	E010/M200X150E15	€ 1,33	M 20 x 1.5 mm	E010/M360X400E15	€ 5,40	M 36 x 4.0 mm
E010/M080X100E15	€ 0,27	M 8 x 1.0 mm	E010/M200X200E15	€ 1,33	M 20 x 2.0 mm	E010/M390X300E15	€ 11,80	M 39 x 3.0 mm
E010/M080X125E15	€ 0,23	M 8 x 1.25 mm	E010/M200X250E15	€ 1,33	M 20 x 2.5 mm	E010/M390X400E15	€ 11,80	M 39 x 4.0 mm
E010/M090X100E15	€ 0,50	M 9 x 1.0 mm	E010/M220X150E15	€ 1,88	M 22 x 1.5 mm	E010/M400X300E15	€ 16,50	M 40 x 3.0 mm
E010/M090X125E15	€ 0,43	M 9 x 1.25 mm	E010/M220X200E15	€ 1,88	M 22 x 2.0 mm	E010/M420X300E15	€ 16,50	M 42 x 3.0 mm
E010/M100X100E15	€ 0,32	M 10 x 1.0 mm	E010/M220X250E15	€ 1,88	M 22 x 2.5 mm	E010/M420X450E15	€ 16,50	M 42 x 4.5 mm
E010/M100X125E15	€ 0,32	M 10 x 1.25 mm	E010/M240X150E15	€ 2,00	M 24 x 1.5 mm	E010/M450X300E15	€ 19,80	M 45 x 3.0 mm
E010/M100X150E15	€ 0,32	M 10 x 1.5 mm	E010/M240X200E15	€ 2,00	M 24 x 2.0 mm	E010/M450X450E15	€ 19,80	M 45 x 4.5 mm
E010/M110X150E15	€ 0,54	M 11 x 1.5 mm	E010/M240X300E15	€ 2,00	M 24 x 3.0 mm	E010/M480X300E15	€ 19,80	M 48 x 3.0 mm
E010/M120X100E15	€ 0,49	M 12 x 1.0 mm	E010/M260X150E15	€ 3,75	M 26 x 1.5 mm	E010/M480X500E15	€ 26,00	M 48 x 5.0 mm
E010/M120X125E15	€ 0,49	M 12 x 1.25 mm	E010/M270X150E15	€ 3,75	M 27 x 1.5 mm	E010/M500X300E15	€ 26,00	M 50 x 3.0 mm
E010/M120X150E15	€ 0,49	M 12 x 1.5 mm	E010/M270X200E15	€ 3,75	M 27 x 2.0 mm	E010/M520X300E15	€ 27,90	M 52 x 3.0 mm
E010/M120X175E15	€ 0,49	M 12 x 1.75 mm	E010/M270X300E15	€ 3,75	M 27 x 3.0 mm	E010/M520X500E15	€ 27,90	M 52 x 5.0 mm
E010/M140X100E15	€ 0,58	M 14 x 1.0 mm	E010/M280X150E15	€ 3,75	M 28 x 1.5 mm			

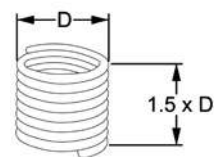

E010-MxE2

CAT 42

STAINLESS STEEL THREAD REPAIR INSERT H=2XD

PACKING OF 25* PIECES UNTIL M10,
PACKING OF 10* PIECES FROM M11 TO M20,
PACKING OF 5* PIECES FROM M22

Art.	€	D	Art.	€	D	Art.	€	D
E010/M020X040E2	€ 0,89	M 2 x 0.4 mm	E010/M100X125E2	€ 0,37	M 10 x 1.25 mm	E010/M180X150E2	€ 1,88	M 18 x 1.5 mm
E010/M022X045E2	€ 0,89	M 2.2 x 0.45 mm	E010/M100X150E2	€ 0,37	M 10 x 1.5 mm	E010/M180X200E2	€ 1,88	M 18 x 2.0 mm
E010/M025X045E2	€ 0,20	M 2.5 x 0.45 mm	E010/M110X150E2	€ 0,58	M 11 x 1.5 mm	E010/M180X250E2	€ 1,88	M 18 x 2.5 mm
E010/M030X050E2	€ 0,20	M 3 x 0.5 mm	E010/M120X100E2	€ 0,55	M 12 x 1.0 mm	E010/M200X150E2	€ 2,25	M 20 x 1.5 mm
E010/M035X060E2	€ 0,23	M 3.5 x 0.6 mm	E010/M120X125E2	€ 0,55	M 12 x 1.25 mm	E010/M200X200E2	€ 2,25	M 20 x 2.0 mm
E010/M040X070E2	€ 0,20	M 4 x 0.7 mm	E010/M120X150E2	€ 0,55	M 12 x 1.5 mm	E010/M200X250E2	€ 2,25	M 20 x 2.5 mm
E010/M050X080E2	€ 0,23	M 5 x 0.8 mm	E010/M120X175E2	€ 0,55	M 12 x 1.75 mm	E010/M220X150E2	€ 2,38	M 22 x 1.5 mm
E010/M060X100E2	€ 0,27	M 6 x 1.0 mm	E010/M140X100E2	€ 0,72	M 14 x 1.0 mm	E010/M220X200E2	€ 2,38	M 22 x 2.0 mm
E010/M070X100E2	€ 0,32	M 7 x 1.0 mm	E010/M140X125E2	€ 0,72	M 14 x 1.25 mm	E010/M220X250E2	€ 2,38	M 22 x 2.5 mm
E010/M080X100E2	€ 0,34	M 8 x 1.0 mm	E010/M140X150E2	€ 0,72	M 14 x 1.5 mm	E010/M240X150E2	€ 2,50	M 24 x 1.5 mm
E010/M080X125E2	€ 0,32	M 8 x 1.25 mm	E010/M140X200E2	€ 0,72	M 14 x 2.0 mm	E010/M240X200E2	€ 2,50	M 24 x 2.0 mm
E010/M090X125E2	€ 0,43	M 9 x 1.25 mm	E010/M160X150E2	€ 1,05	M 16 x 1.5 mm	E010/M240X300E2	€ 2,50	M 24 x 3.0 mm
E010/M100X100E2	€ 0,37	M 10 x 1.0 mm	E010/M160X200E2	€ 1,05	M 16 x 2.0 mm			

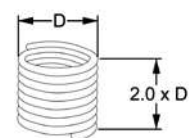

E010-MxE25

CAT 42

STAINLESS STEEL THREAD REPAIR INSERT H=2,5XD

PACKING OF 25* PIECES UNTIL M10,
PACKING OF 10* PIECES FROM M11 TO M20,
PACKING OF 5* PIECES FROM M22

Art.	€	D	Art.	€	D	Art.	€	D
E010/M020X040E25	€ 1,00	2 x 0.4 mm	E010/M100X125E25	€ 0,44	10 x 1.25 mm	E010/M180X150E25	€ 2,13	18 x 1.5 mm
E010/M022X045E25	€ 1,00	2.2 x 0.45 mm	E010/M100X150E25	€ 0,44	10 x 1.5 mm	E010/M180X200E25	€ 2,13	18 x 2.0 mm
E010/M025X045E25	€ 0,24	2.5 x 0.45 mm	E010/M110X150E25	€ 0,65	11 x 1.5 mm	E010/M180X250E25	€ 2,13	18 x 2.5 mm
E010/M030X050E25	€ 0,24	3 x 0.5 mm	E010/M120X100E25	€ 0,65	12 x 1.0 mm	E010/M200X150E25	€ 2,50	20 x 1.5 mm
E010/M035X060E25	€ 0,27	3.5 x 0.6 mm	E010/M120X125E25	€ 0,65	12 x 1.25 mm	E010/M200X200E25	€ 2,50	20 x 2.0 mm
E010/M040X070E25	€ 0,24	4 x 0.7 mm	E010/M120X150E25	€ 0,65	12 x 1.5 mm	E010/M200X250E25	€ 2,50	20 x 2.5 mm
E010/M050X080E25	€ 0,28	5 x 0.8 mm	E010/M120X175E25	€ 0,65	12 x 1.75 mm	E010/M220X150E25	€ 2,75	22 x 1.5 mm
E010/M060X100E25	€ 0,32	6 x 1.0 mm	E010/M140X100E25	€ 0,87	14 x 1.0 mm	E010/M220X200E25	€ 2,75	22 x 2.0 mm
E010/M070X100E25	€ 0,38	7 x 1.0 mm	E010/M140X125E25	€ 0,87	14 x 1.25 mm	E010/M220X250E25	€ 2,75	22 x 2.5 mm
E010/M080X100E25	€ 0,40	8 x 1.0 mm	E010/M140X150E25	€ 0,87	14 x 1.5 mm	E010/M240X150E25	€ 3,00	24 x 1.5 mm
E010/M080X125E25	€ 0,38	8 x 1.25 mm	E010/M140X200E25	€ 0,87	14 x 2.0 mm	E010/M240X200E25	€ 3,00	24 x 2.0 mm
E010/M090X125E25	€ 0,47	9 x 1.25 mm	E010/M160X150E25	€ 1,15	16 x 1.5 mm	E010/M240X300E25	€ 3,00	24 x 3.0 mm
E010/M100X100E25	€ 0,44	10 x 1.0 mm	E010/M160X200E25	€ 1,15	16 x 2.0 mm			

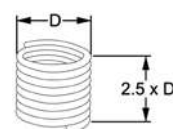

E010-MxE3

CAT 42

STAINLESS STEEL THREAD REPAIR INSERT H=3XD

PACKING OF 25* PIECES UNTIL M10, PACKING OF 10* PIECES FROM M11 TO M20,
PACKING OF 5* PIECES FROM M22

Art.	€	D	Art.	€	D	Art.	€	D
E010/M020X040E3	€ 1,25	M 2 x 0.4 mm	E010/M100X125E3	€ 0,53	M 10 x 1.25 mm	E010/M180X150E3	€ 2,50	M 18 x 1.5 mm
E010/M022X045E3	€ 1,25	M 2.2 x 0.45 mm	E010/M100X150E3	€ 0,53	M 10 x 1.5 mm	E010/M180X200E3	€ 2,50	M 18 x 2.0 mm
E010/M025X045E3	€ 0,29	M 2.5 x 0.45 mm	E010/M110X150E3	€ 0,79	M 11 x 1.5 mm	E010/M180X250E3	€ 2,50	M 18 x 2.5 mm
E010/M030X050E3	€ 0,29	M 3 x 0.5 mm	E010/M120X100E3	€ 0,79	M 12 x 1.0 mm	E010/M200X150E3	€ 2,88	M 20 x 1.5 mm
E010/M035X060E3	€ 0,32	M 3.5 x 0.6 mm	E010/M120X125E3	€ 0,79	M 12 x 1.25 mm	E010/M200X200E3	€ 2,88	M 20 x 2.0 mm
E010/M040X070E3	€ 0,27	M 4 x 0.7 mm	E010/M120X150E3	€ 0,79	M 12 x 1.5 mm	E010/M200X250E3	€ 2,88	M 20 x 2.5 mm
E010/M050X080E3	€ 0,33	M 5 x 0.8 mm	E010/M120X175E3	€ 0,79	M 12 x 1.75 mm	E010/M220X150E3	€ 3,13	M 22 x 1.5 mm
E010/M060X100E3	€ 0,39	M 6 x 1.0 mm	E010/M140X100E3	€ 1,05	M 14 x 1.0 mm	E010/M220X200E3	€ 3,13	M 22 x 2.0 mm
E010/M070X100E3	€ 0,45	M 7 x 1.0 mm	E010/M140X125E3	€ 1,05	M 14 x 1.25 mm	E010/M220X250E3	€ 3,13	M 22 x 2.5 mm
E010/M080X100E3	€ 0,49	M 8 x 1.0 mm	E010/M140X150E3	€ 1,05	M 14 x 1.5 mm	E010/M240X150E3	€ 3,50	M 24 x 1.5 mm
E010/M080X125E3	€ 0,45	M 8 x 1.25 mm	E010/M140X200E3	€ 1,25	M 14 x 2.0 mm	E010/M240X200E3	€ 3,50	M 24 x 2.0 mm
E010/M090X125E3	€ 0,55	M 9 x 1.25 mm	E010/M160X150E3	€ 1,25	M 16 x 1.5 mm	E010/M240X300E3	€ 3,50	M 24 x 3.0 mm
E010/M100X100E3	€ 0,53	M 10 x 1.0 mm	E010/M160X200E3	€ 1,25	M 16 x 2.0 mm			



E010-MxEa

CAT 42

SELF-LOCK STAINLESS STEEL THREAD REPAIR INSERT H=1.5XD

PACKING OF 25* PIECES UNTIL M10, PACKING OF 10* PIECES FROM M11

Art.	€	D	Height	Art.	€	D	Height
E010/M030X050E1A	€ 0,28	M 3 x 0.5 mm	1.0 D mm	E010/M100X150E15A	€ 0,50	M 10 x 1.5 mm	1.5 D mm
E010/M040X070E1A	€ 0,28	M 4 x 0.7 mm	1.0 D mm	E010/M120X175E15A	€ 0,78	M 12 x 1.75 mm	1.5 D mm
E010/M050X080E1A	€ 0,32	M 5 x 0.8 mm	1.0 D mm	E010/M140X200E15A	€ 1,10	M 14 x 2.0 mm	1.5 D mm
E010/M060X100E1A	€ 0,35	M 6 x 1.0 mm	1.0 D mm	E010/M160X200E15A	€ 1,37	M 16 x 2.0 mm	1.5 D mm
E010/M080X125E1A	€ 0,37	M 8 x 1.25 mm	1.0 D mm	E010/M030X050E2A	€ 0,32	M 3 x 0.5 mm	2.0 D mm
E010/M100X150E1A	€ 0,47	M 10 x 1.5 mm	1.0 D mm	E010/M040X070E2A	€ 0,32	M 4 x 0.7 mm	2.0 D mm
E010/M120X175E1A	€ 0,68	M 12 x 1.75 mm	1.0 D mm	E010/M050X080E2A	€ 0,37	M 5 x 0.8 mm	2.0 D mm
E010/M140X200E1A	€ 0,97	M 14 x 2.0 mm	1.0 D mm	E010/M060X100E2A	€ 0,42	M 6 x 1.0 mm	2.0 D mm
E010/M160X200E1A	€ 1,30	M 16 x 2.0 mm	1.0 D mm	E010/M080X125E2A	€ 0,50	M 8 x 1.25 mm	2.0 D mm
E010/M030X050E15A	€ 0,30	M 3 x 0.5 mm	1.5 D mm	E010/M100X150E2A	€ 0,58	M 10 x 1.5 mm	2.0 D mm
E010/M040X070E15A	€ 0,30	M 4 x 0.7 mm	1.5 D mm	E010/M120X175E2A	€ 0,88	M 12 x 1.75 mm	2.0 D mm
E010/M050X080E15A	€ 0,33	M 5 x 0.8 mm	1.5 D mm	E010/M140X200E2A	€ 1,15	M 14 x 2.0 mm	2.0 D mm
E010/M060X100E15A	€ 0,38	M 6 x 1.0 mm	1.5 D mm	E010/M160X200E2A	€ 1,68	M 16 x 2.0 mm	2.0 D mm
E010/M080X125E15A	€ 0,42	M 8 x 1.5 mm	1.5 D mm				

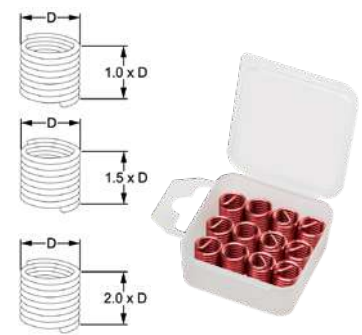

E010-BSWxEx

CAT 42

STAINLESS STEEL THREAD REPAIR INSERT BSW H=1.5XD

PACKING OF 10* PIECES UNTIL 1/2", PACKING OF 5* PIECES FROM 9/16"

Art.	€	D	Art.	€	D
E010/BSW1/8E15	€ 0,92	1/8" x 40 mm	E010/BSW1/2E15	€ 0,92	1/2" x 12 mm
E010/BSW3/16E15	€ 0,92	3/16" x 24 mm	E010/BSW9/16E15	€ 2,92	9/16" x 12 mm
E010/BSW1/4E15	€ 0,43	1/4" x 20 mm	E010/BSW5/8E15	€ 2,92	5/8" x 11 mm
E010/BSW5/16E15	€ 0,50	5/16" x 18 mm	E010/BSW3/4E15	€ 3,33	3/4" x 10 mm
E010/BSW3/8E15	€ 0,79	3/8" x 16 mm	E010/BSW7/8E15	€ 4,96	7/8" x 9 mm
E010/BSW7/16E15	€ 0,92	7/16" x 14 mm	E010/BSW1E15	€ 5,40	1" x 8 mm

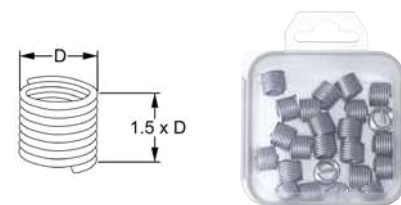

E010-BSFxEx

CAT 42

STAINLESS STEEL THREAD REPAIR INSERT BSF H=1.5XD

PACKING OF 10* PIECES UNTIL 1/2", PACKING OF 5* PIECES FROM 9/16"

Art.	€	D	Art.	€	D
E010/BSF3/16E15	€ 0,92	3/16" x 32 mm	E010/BSF9/16E15	€ 3,17	9/16" x 16 mm
E010/BSF1/4E15	€ 0,43	1/4" x 26 mm	E010/BSF5/8E15	€ 3,17	5/8" x 14 mm
E010/BSF5/16E15	€ 0,50	5/16" x 22 mm	E010/BSF3/4E15	€ 4,00	3/4" x 12 mm
E010/BSF3/8E15	€ 0,79	3/8" x 20 mm	E010/BSF7/8E15	€ 4,96	7/8" x 11 mm
E010/BSF7/16E15	€ 0,92	7/16" x 18 mm	E010/BSF1E15	€ 4,96	1" x 10 mm
E010/BSF1/2E15	€ 0,92	1/2" x 16 mm			

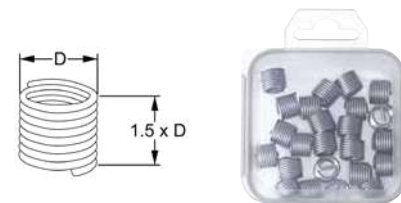

E010-BSPxEx

CAT 42

STAINLESS STEEL THREAD REPAIR INSERT BSP H=1.5XD

PACKING OF 10* PIECES UNTIL 1/2", PACKING OF 5* PIECES FROM 9/16"

Art.	€	D	Art.	€	D
E010/BSP1/8E15	€ 0,71	1/8" x 28 mm	E010/BSP5/8E15	€ 3,33	5/8" x 14 mm
E010/BSP1/4E15	€ 0,83	1/4" x 19 mm	E010/BSP3/4E15	€ 3,33	3/4" x 14 mm
E010/BSP3/8E15	€ 1,08	3/8" x 19 mm	E010/BSP7/8E15	€ 10,00	7/8" x 14 mm
E010/BSP1/2E15	€ 1,24	1/2" x 14 mm	E010/BSP1E15	€ 10,00	1" x 11 mm

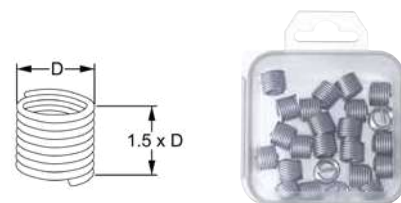

E010-UNCxEx

CAT 42

STAINLESS STEEL THREAD REPAIR INSERT UNC H=1,5XD

PACKING OF 10* PIECES UNTIL 1/2", PACKING OF 5* PIECES FROM 9/16"

Art.	€	D
E010/UNCN02E15	€ 1,04	2" x 56 mm
E010/UNCN04E15	€ 0,32	4" x 40 mm
E010/UNCN05E15	€ 0,38	5" x 40 mm
E010/UNCN06E15	€ 0,30	6" x 32 mm
E010/UNCN08E15	€ 0,30	8" x 32 mm
E010/UNCN10E15	€ 0,34	10" x 24 mm
E010/UNCN12E15	€ 0,40	12" x 24 mm
E010/UNC1/4E15	€ 0,40	1/4" x 20 mm
E010/UNC5/16E15	€ 0,56	5/16" x 18 mm

Art.	€	D
E010/UNC3/8E15	€ 0,74	3/8" x 16 mm
E010/UNC7/16E15	€ 0,98	7/16" x 14 mm
E010/UNC1/2E15	€ 0,98	1/2" x 13 mm
E010/UNC9/16E15	€ 1,05	9/16" x 12 mm
E010/UNC5/8E15	€ 2,12	5/8" x 11 mm
E010/UNC3/4E15	€ 3,00	3/4" x 10 mm
E010/UNC7/8E15	€ 4,50	7/8" x 9 mm
E010/UNC1E15	€ 4,50	1" x 8 mm

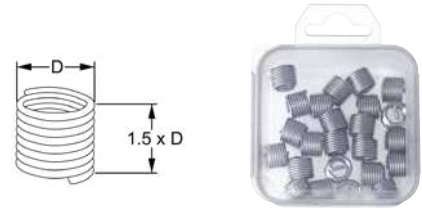

E010-UNFxEx

CAT 42

STAINLESS STEEL THREAD REPAIR INSERT UNF H=1,5XD

PACKING OF 10* PIECES UNTIL 1/2", PACKING OF 5* PIECES FROM 9/16"

Art.	€	D
E010/UNFN04E15	€ 0,90	4" x 48 mm
E010/UNFN06E15	€ 0,90	6" x 40 mm
E010/UNFN08E15	€ 0,90	8" x 36 mm
E010/UNFN10E15	€ 0,36	10" x 32 mm
E010/UNF1/4E15	€ 0,36	1/4" x 28 mm
E010/UNF5/16E15	€ 0,51	5/16" x 24 mm
E010/UNF3/8E15	€ 0,74	3/8" x 24 mm

Art.	€	D
E010/UNF7/16E15	€ 0,98	7/16" x 20 mm
E010/UNF1/2E15	€ 0,98	1/2" x 20 mm
E010/UNF9/16E15	€ 2,05	9/16" x 18 mm
E010/UNF5/8E15	€ 2,05	5/8" x 18 mm
E010/UNF3/4E15	€ 2,05	3/4" x 16 mm
E010/UNF7/8E15	€ 5,30	7/8" x 14 mm
E010/UNF1E15	€ 5,30	1" x 12 mm

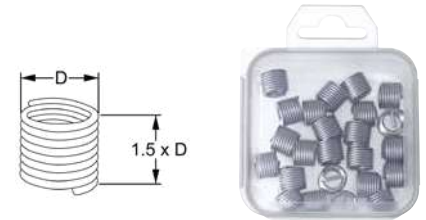

E011-MxM

CAT 42

METRIC F-COIL STI TAP

Art.	€	Size	B	L1	L2	D2	C
E011/M020X040M	€ 9,50	M 2 x 0.40	2.5 mm	44.5 mm	9.5 mm	2.8 mm	2.24 mm
E011/M025X045M	€ 9,50	M 2.5 x 0.45	3.1 mm	48.0 mm	11.0 mm	3.15 mm	2.5 mm
E011/M030X050M	€ 9,50	M 3 x 0.5	3.6 mm	53.0 mm	13.0 mm	4.0 mm	3.15 mm
E011/M035X060M	€ 9,50	M 3.5 x 0.6	4.3 mm	53.0 mm	13.0 mm	4.5 mm	3.55 mm
E011/M040X070M	€ 9,50	M 4 x 0.7	4.9 mm	58 mm	16.0 mm	5.0 mm	4.00 mm
E011/M050X080M	€ 9,50	M 5 x 0.8	6.0 mm	66.0 mm	19.0 mm	6.3 mm	5.00 mm
E011/M060X100M	€ 9,50	M 6 x 1.0	7.3 mm	72.0 mm	22.0 mm	8.0 mm	6.30 mm
E011/M070X100M	€ 11,00	M 7 x 1.0	8.3 mm	72.0 mm	22.0 mm	9.0 mm	7.10 mm
E011/M080X100M	€ 11,00	M 8 x 1.25	9.6 mm	80.0 mm	24.0 mm	10.0 mm	8.00 mm
E011/M080X125M	€ 11,00	M 8 x 1.0	9.3 mm	80.0 mm	24.0 mm	8.0 mm	8.00 mm
E011/M090X100M	€ 12,60	M 9 x 1.0	10.6 mm	85.0 mm	25.0 mm	8.0 mm	6.30 mm
E011/M090X125M	€ 12,60	M 9 x 1.25	10.6 mm	85.0 mm	25.0 mm	8.0 mm	6.30 mm
E011/M100X100M	€ 12,60	M 10 x 1.0	11.3 mm	85.0 mm	25.0 mm	8.0 mm	6.30 mm
E011/M100X125M	€ 12,60	M 10 x 1.25	11.6 mm	85.0 mm	25.0 mm	8.0 mm	6.30 mm
E011/M100X150M	€ 12,60	M 10 x 1.5	11.9 mm	89.0 mm	29.0 mm	9.0 mm	7.10 mm
E011/M110X150M	€ 16,50	M 11 x 1.5	12.9 mm	89.0 mm	29.0 mm	9.0 mm	7.10 mm
E011/M120X100M	€ 16,50	M 12 x 1.0	13.3 mm	95.0 mm	30.0 mm	11.2 mm	9.00 mm
E011/M120X125M	€ 17,30	M 12 x 1.25	13.6 mm	95.0 mm	30.0 mm	11.2 mm	9.00 mm
E011/M120X150M	€ 17,30	M 12 x 1.5	14.0 mm	95.0 mm	30.0 mm	11.2 mm	9.00 mm
E011/M120X175M	€ 17,30	M 12 x 1.75	14.3 mm	95.0 mm	30.0 mm	11.2 mm	9.00 mm
E011/M140X100M	€ 19,70	M 14 x 1.0	15.3 mm	102.0 mm	32.0 mm	12.5 mm	10.00 mm
E011/M140X125M	€ 19,70	M 14 x 1.25	15.6 mm	102.0 mm	32.0 mm	12.5 mm	10.00 mm
E011/M140X150M	€ 19,70	M 14 x 1.5	16.0 mm	102.0 mm	32.0 mm	12.5 mm	10.00 mm
E011/M140X200M	€ 19,70	M 14 x 2.0	16.6 mm	102.0 mm	32.0 mm	12.5 mm	10.00 mm
E011/M160X150M	€ 24,40	M 16 x 1.5	18.0 mm	104.0 mm	29.0 mm	14.0 mm	11.20 mm
E011/M160X200M	€ 24,40	M 16 x 2.0	18.6 mm	112.0 mm	37.0 mm	14.0 mm	11.20 mm
E011/M180X150M	€ 26,00	M 18 x 1.5	20.0 mm	104.0 mm	29.0 mm	14.0 mm	11.20 mm
E011/M180X200M	€ 26,00	M 18 x 2.0	20.6 mm	104.0 mm	29.0 mm	14.0 mm	11.20 mm
E011/M180X250M	€ 26,00	M 18 x 2.5	21.3 mm	118.0 mm	38.0 mm	16.0 mm	12.50 mm
E011/M200X150M	€ 29,10	M 20 x 1.5	22.0 mm	113.0 mm	33.0 mm	16.0 mm	12.50 mm
E011/M200X200M	€ 29,10	M 20 x 2.0	22.6 mm	113.0 mm	33.0 mm	16.0 mm	12.50 mm
E011/M200X250M	€ 29,10	M 20 x 2.5	23.3 mm	118.0 mm	38.0 mm	16.0 mm	12.50 mm
E011/M220X150M	€ 37,00	M 22 x 1.5	24.0 mm	120.0 mm	35.0 mm	18.0 mm	14.00 mm
E011/M220X200M	€ 37,00	M 22 x 2.0	24.6 mm	120.0 mm	35.0 mm	18.0 mm	14.00 mm
E011/M220X250M	€ 37,00	M 22 x 2.5	25.3 mm	130.0 mm	45.0 mm	18.0 mm	14.00 mm
E011/M240X150M	€ 39,40	M 24 x 1.5	26.0 mm	120.0 mm	35.0 mm	18.0 mm	14.00 mm
E011/M240X200M	€ 39,40	M 24 x 2.0	26.6 mm	127.0 mm	37.0 mm	20.0 mm	16.00 mm
E011/M240X300M	€ 39,40	M 24 x 3.0	27.9 mm	138.0 mm	48.0 mm	20.0 mm	16.00 mm

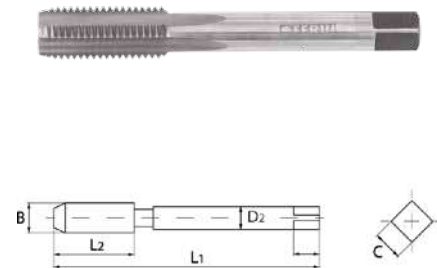

E011-MxM2

CAT 42

METRIC F-COIL 2 PCS STI TAPS

Art.	€	Size	B	L1	L2	D2	C
E011/M260X150M	€ 130,00	M 26 x 1.5	28.0 mm	127 mm	37 mm	20.0 mm	16.0 mm
E011/M270X150M	€ 130,00	M 27 x 1.5	29.0 mm	127 mm	37 mm	20.0 mm	16.0 mm
E011/M270X200M	€ 130,00	M 27 x 2.0	29.6 mm	127 mm	37 mm	20.0 mm	16.0 mm
E011/M270X300M	€ 130,00	M 27 x 3.0	30.9 mm	151 mm	51 mm	22.4 mm	18.0 mm
E011/M280X150M	€ 158,00	M 28 x 1.5	30.0 mm	127 mm	37 mm	20.0 mm	16.0 mm
E011/M300X150M	€ 158,00	M 30 x 1.5	32.0 mm	137 mm	37 mm	22.4 mm	18.0 mm
E011/M300X200M	€ 158,00	M 30 x 2.0	32.6 mm	137 mm	37 mm	22.4 mm	18.0 mm
E011/M300X350M	€ 158,00	M 30 x 3.5	34.6 mm	162 mm	57 mm	25.0 mm	20.0 mm
E011/M330X200M	€ 158,00	M 33 x 2.0	35.6 mm	144 mm	37 mm	25.0 mm	20.0 mm
E011/M330X350M	€ 158,00	M 33 x 3.5	37.6 mm	162 mm	57 mm	25.0 mm	20.0 mm
E011/M360X150M	€ 181,00	M 36 x 1.5	38.0 mm	150 mm	39 mm	28.0 mm	22.4 mm
E011/M360X200M	€ 181,00	M 36 x 2.0	38.6 mm	150 mm	39 mm	28.0 mm	22.4 mm
E011/M360X300M	€ 181,00	M 36 x 3.0	39.9 mm	170 mm	60 mm	28.0 mm	22.4 mm
E011/M360X400M	€ 181,00	M 36 x 4.0	41.2 mm	170 mm	60 mm	28.0 mm	22.4 mm
E011/M390X300M	€ 273,00	M 39 x 3.0	42.9 mm	149 mm	39 mm	28.0 mm	26.0 mm
E011/M390X400M	€ 233,00	M 39 x 4.0	44.2 mm	187 mm	67 mm	31.5 mm	28.0 mm
E011/M400X300M	€ 233,00	M 40 x 3.0	43.9 mm	149 mm	39 mm	28.0 mm	26.0 mm
E011/M420X300M	€ 385,00	M 42 x 3.0	45.9 mm	165 mm	45 mm	31.5 mm	28.0 mm
E011/M420X450M	€ 253,00	M 42 x 4.5	47.9 mm	187 mm	67 mm	31.5 mm	28.0 mm
E011/M450X300M	€ 385,00	M 45 x 3.0	48.9 mm	175 mm	45 mm	35.5 mm	31.0 mm
E011/M450X450M	€ 294,00	M 45 x 4.5	50.9 mm	200 mm	70 mm	35.5 mm	31.0 mm
E011/M480X300M	€ 476,00	M 48 x 3.0	51.9 mm	175 mm	45 mm	35.5 mm	31.0 mm
E011/M480X500M	€ 324,00	M 48 x 5.0	54.5 mm	200 mm	70 mm	35.5 mm	31.0 mm
E011/M500X300M	€ 354,00	M 50 x 3.0	53.9 mm	175 mm	45 mm	35.5 mm	31.0 mm
E011/M520X300M	€ 658,00	M 52 x 3.0	55.9 mm	193 mm	48 mm	40.0 mm	34.0 mm
E011/M520X500M	€ 557,00	M 52 x 3.0	58.5 mm	221 mm	76 mm	40.0 mm	34.0 mm

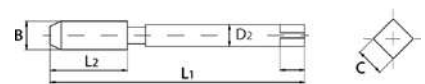

E011-MxMC

CAT 42

METRIC F-COIL STI COMBINED TAP

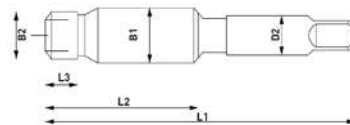

Art.	€	Size	B1	B2	L3	L2	L1	D2	C
E011/M060X100MC	€ 13,40	M 6 x 1.0 mm	7.3 mm	6 mm	7 mm	28 mm	70 mm	8 mm	6.3 mm
E011/M080X125MC	€ 13,40	M 8 x 1.25 mm	9.6 mm	8 mm	9 mm	32 mm	75 mm	8 mm	6.3 mm
E011/M100X100MC	€ 18,90	M 10 x 1.0 mm	11.3 mm	8 mm	8 mm	30 mm	74 mm	8 mm	6.3 mm
E011/M100X125MC	€ 18,90	M 10 x 1.25 mm	11.6 mm	10 mm	8 mm	30 mm	74 mm	8 mm	6.3 mm
E011/M100X150MC	€ 18,90	M 10 x 1.5 mm	11.9 mm	10 mm	9 mm	37 mm	80 mm	9 mm	7.1 mm
E011/M120X125MC	€ 24,40	M 12 x 1.25 mm	13.6 mm	10 mm	9 mm	32 mm	75 mm	9 mm	7.1 mm
E011/M140X125MC	€ 26,80	M 14 x 1.25 mm	15.6 mm	14 mm	10 mm	45 mm	90 mm	12 mm	9.2 mm
E011/M180X150MC	€ 39,40	M 18 x 1.25 mm	20.0 mm	18 mm	10 mm	47 mm	116 mm	16 mm	12.5 mm

E011-BSWxM

CAT 42

BSW F-COIL STI TAP

Art.	€	Size	B	L1	L2	D2	C
E011/BSW1/8M	€ 8,70	1/8" x 40	3.9 mm	53.0 mm	13.0 mm	4.0 mm	3.15 mm
E011/BSW3/16M	€ 8,70	3/16" x 24	6.0 mm	56.0 mm	19.0 mm	6.3 mm	5.00 mm
E011/BSW1/4M	€ 8,70	1/4" x 20	7.8 mm	72.0 mm	22.0 mm	8.0 mm	6.30 mm
E011/BSW5/16M	€ 9,50	5/16" x 18	9.6 mm	80.0 mm	24.0 mm	10.0 mm	8.00 mm
E011/BSW3/8M	€ 10,20	3/8" x 16	11.4 mm	85.0 mm	25.0 mm	8.0 mm	6.30 mm
E011/BSW7/16M	€ 11,00	7/16" x 14	13.2 mm	95.0 mm	30.0 mm	11.2 mm	9.00 mm
E011/BSW1/2M	€ 12,20	1/2" x 12	15.2 mm	102.0 mm	32.0 mm	12.5 mm	10.00 mm
E011/BSW9/16M	€ 18,40	9/16" x 12	16.8 mm	102.0 mm	32.0 mm	12.5 mm	10.00 mm
E011/BSW5/8M	€ 22,60	5/8" x 11	18.6 mm	112.0 mm	37.0 mm	14.0 mm	11.20 mm
E011/BSW3/4M	€ 27,30	3/4" x 10	22.0 mm	118.0 mm	38.0 mm	16.0 mm	12.50 mm
E011/BSW7/8M	€ 36,90	7/8" x 9	25.5 mm	130.0 mm	45.0 mm	18.0 mm	14.00 mm
E011/BSW1M	€ 36,90	1" x 8	29.1 mm	138.0 mm	48.0 mm	20.0 mm	16.0 mm

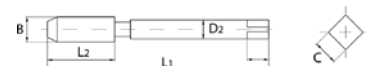

E011-BSFxM
CAT 42
BSF F-COIL STI TAP

Art.	€	Size	B	L1	L2	D2	C
E011/BSF3/16M	€ 8,70	3/16" x 32	5.7 mm	66.0 mm	19.0 mm	6.3 mm	5.00 mm
E011/BSF1/4M	€ 8,70	1/4" x 26	7.5 mm	72.0 mm	22.0 mm	8.0 mm	6.30 mm
E011/BSF5/16M	€ 9,50	5/16" x 22	9.3 mm	80.0 mm	24.0 mm	10.0 mm	8.00 mm
E011/BSF3/8M	€ 10,20	3/8" x 20	11.0 mm	85.0 mm	25.0 mm	8.0 mm	6.30 mm
E011/BSF7/16M	€ 11,00	7/16" x 18	12.8 mm	89.0 mm	29.0 mm	9.0 mm	7.10 mm
E011/BSF1/2M	€ 12,20	1/2" x 16	14.6 mm	95.0 mm	30.0 mm	11.2 mm	9.00 mm
E011/BSF9/16M	€ 18,40	9/16" x 16	16.2 mm	102.0 mm	32.0 mm	12.5 mm	10.00 mm
E011/BSF5/8M	€ 22,60	5/8" x 14	18.0 mm	112.0 mm	37.0 mm	14.0 mm	11.20 mm
E011/BSF3/4M	€ 27,30	3/4" x 12	21.5 mm	118.0 mm	38.0 mm	16.0 mm	12.5 mm
E011/BSF7/8M	€ 36,90	7/8" x 11	24.9 mm	130.0 mm	45.0 mm	18.0 mm	14.00 mm
E011/BSF1M	€ 36,90	1" x 10	28.4 mm	138.0 mm	48.0 mm	20.0 mm	16.00 mm

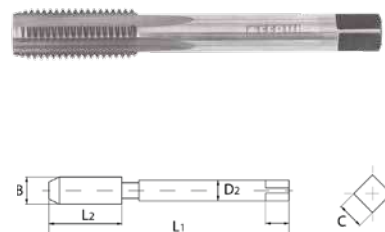
E011-BSPxM
CAT 42
BSF F-COIL STI 2PCS TAPS

Art.	€	Size	B	L1	L2	D2	C
E011/BSP1/8M	€ 22,80	1/8" x 28	10.8 mm	59 mm	15 mm	8.0 mm	6.3 mm
E011/BSP1/4M	€ 23,60	1/4" x 19	14.7 mm	67 mm	19 mm	11.2 mm	9.0 mm
E011/BSP3/8M	€ 30,70	3/8" x 19	18.3 mm	75 mm	21 mm	14.0 mm	11.2 mm
E011/BSP1/2M	€ 48,00	1/2" x 14	23.1 mm	87 mm	26 mm	16.0 mm	12.5 mm
E011/BSP5/8M	€ 67,70	5/8" x 14	25.1 mm	91 mm	26 mm	18.0 mm	14.0 mm
E011/BSP3/4M	€ 67,70	3/4" x 14	28.6 mm	96 mm	28 mm	20.0 mm	16.0 mm
E011/BSP7/8M	€ 107,00	7/8" x 14	32.4 mm	102 mm	29 mm	22.4 mm	18.0 mm
E011/BSP1M	€ 107,00	1" x 11	36.0 mm	109 mm	33 mm	25.0 mm	20.0 mm

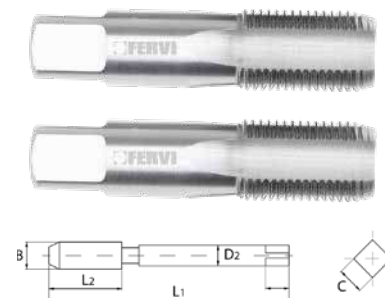
E011-UNCxM
CAT 42
UNC F-COIL STI TAP

Art.	€	Size	B	L1	L2	D2	C
E011/UNCN02M	€ 10,10	2" x 56	2.8 mm	48.0 mm	10.0 mm	3.15 mm	2.5 mm
E011/UNCN04M	€ 10,10	4" x 40	3.7 mm	53.0 mm	13.0 mm	4.0 mm	3.15 mm
E011/UNCN05M	€ 10,10	5" x 40	4.0 mm	53.0 mm	13.0 mm	4.0 mm	3.15 mm
E011/UNCN06M	€ 10,10	6" x 32	4.5 mm	58.0 mm	16.0 mm	5.0 mm	4.00 mm
E011/UNCN08M	€ 10,10	8" x 32	5.2 mm	62.0 mm	17.0 mm	5.6 mm	4.50 mm
E011/UNCN10M	€ 10,10	10" x 24	6.2 mm	66.0 mm	19.0 mm	6.3 mm	5.00 mm
E011/UNCN12M	€ 10,10	12" x 24	6.9 mm	66.0 mm	19.0 mm	7.1 mm	5.60 mm
E011/UNC1/4M	€ 8,70	1/4" x 20	8.0 mm	72.0 mm	22.0 mm	8.0 mm	6.30 mm
E011/UNC5/16M	€ 9,50	5/16" x 18	9.8 mm	80.0 mm	24.0 mm	10.0 mm	8.00 mm
E011/UNC3/8M	€ 10,20	3/8" x 16	11.6 mm	85.0 mm	25.0 mm	8.0 mm	6.30 mm
E011/UNC7/16M	€ 11,00	7/16" x 14	13.5 mm	95.0 mm	30.0 mm	11.2 mm	10.00 mm
E011/UNC1/2M	€ 12,20	1/2" x 13	15.2 mm	102.0 mm	32.0 mm	12.5 mm	10.00 mm
E011/UNC9/16M	€ 18,40	9/16" x 12	17.0 mm	112.0 mm	37.0 mm	14.0 mm	11.20 mm
E011/UNC5/8M	€ 22,60	5/8" x 11	18.9 mm	112.0 mm	37.0 mm	14.0 mm	11.20 mm
E011/UNC3/4M	€ 27,30	3/4" x 10	22.4 mm	118.0 mm	38.0 mm	16.0 mm	12.50 mm
E011/UNC7/8M	€ 36,90	7/8" x 9	25.9 mm	130.0 mm	45.0 mm	18.0 mm	14.00 mm
E011/UNC1M	€ 36,90	1" x 8	29.5 mm	138.0 mm	48.0 mm	20.0 mm	16.00 mm

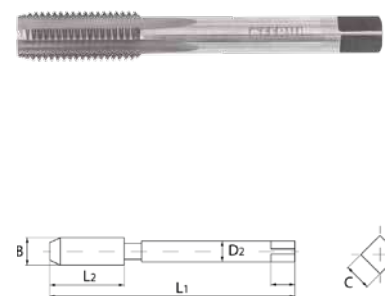
E011-UNFxM
CAT 42
UNF F-COIL STI TAP

Art.	€	Size	B	L1	L2	D2	C
E011/UNFN04M	€ 11,00	4" x 48	3.5 mm	53.0 mm	13.0 mm	4.0 mm	3.15 mm
E011/UNFN06M	€ 11,00	6" x 40	4.3 mm	53.0 mm	13.0 mm	4.5 mm	3.55 mm
E011/UNFN08M	€ 11,00	8" x 36	5.1 mm	62.0 mm	17.0 mm	5.6 mm	4.50 mm
E011/UNFN10M	€ 11,00	10" x 32	5.9 mm	66.0 mm	19.0 mm	6.3 mm	5.00 mm
E011/UNF1/4M	€ 8,70	1/4" x 28	7.5 mm	69.0 mm	19.0 mm	8.0 mm	6.30 mm
E011/UNF5/16M	€ 9,50	5/16" x 24	9.3 mm	76.0 mm	20.0 mm	10.0 mm	8.00 mm
E011/UNF3/8M	€ 10,20	3/8" x 24	10.9 mm	82.0 mm	22.0 mm	8.0 mm	6.3 mm
E011/UNF7/16M	€ 11,00	7/16" x 20	12.8 mm	84.0 mm	24.0 mm	9.0 mm	7.10 mm
E011/UNF1/2M	€ 12,20	1/2" x 20	14.4 mm	90.0 mm	25.0 mm	11.2 mm	9.00 mm
E011/UNF9/16M	€ 18,40	9/16" x 18	16.1 mm	104.0 mm	29.0 mm	12.5 mm	10.00 mm
E011/UNF5/8M	€ 22,60	5/8" x 18	17.7 mm	104.0 mm	29.0 mm	14.0 mm	11.20 mm
E011/UNF3/4M	€ 27,30	3/4" x 16	21.1 mm	104.0 mm	29.0 mm	14.0 mm	11.20 mm
E011/UNF7/8M	€ 36,90	7/8" x 14	24.6 mm	120.0 mm	35.0 mm	18.0 mm	14.00 mm
E011/UNF11/2M	€ 36,90	1" x 12	28.2 mm	127.0 mm	37.0 mm	20.0 mm	16.00 mm

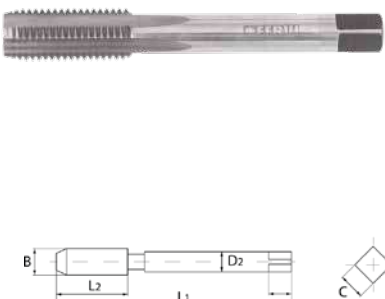

E011-Ux

CAT 42

F-COIL MOUNTING TOOL

Art.	€	Metric	Inch
E011/U02	€ 6,70	M 2 x 0.4 - M 2.2 x 0.45	UNC N02
E011/U03	€ 6,70	M 2.5 x 0.45	
E011/U04	€ 6,70	M 3 x 0.5	UNC N05 - UNC/UNF N04 - BSW 1/8"
E011/U05	€ 6,70	M 3.5 x 0.6	UNC/UNF N06
E011/U06	€ 6,70	M 4 x 0.7	UNC/UNF N08
E011/U08	€ 6,70	M 5 x 0.8	UNF N10 - UNC N12 - BSF 3/16"
E011/U09	€ 6,70	M 6 x 1.0	UNC/UNF 1/4" - BSW/BSF 1/4"
E011/U10	€ 6,70	M 7 x 1.0	UNC/BSW 5/16"
E011/U11	€ 7,50	M 8 x 1.25 - M 8 x 1.0	UNF/BSF 5/16"
E011/U12	€ 11,40	M 9 x 1.25 - M 9 x 1.0	UNC/BSW 3/8"
E011/U13	€ 11,40	M 10 x 1.5 - M 10 x 1.0 - M 10 x 1.25	UNF/BSF 3/8"
E011/U14	€ 12,30	M 11 x 1.5	UNC/UNF 7/16" - BSW-BSF 7/16"
E011/U15	€ 12,30	M 12 x 1.75 - M 12 x 1.5 - M 12 x 1.25 - M 12 x 1.0	UNC/UNF 1/2" - BSW-BSF 1/2"
E011/U16	€ 14,00	M 14 x 2.0 - M 14 x 1.5	UNC/UNF 9/16" - BSW-BSF 9/16"
E011/U17	€ 14,00	M 14 x 1.25 - M 14 x 1.0	
E011/U18	€ 15,30	M 16 x 2.0 - M 16 x 1.5	UNC/UNF 5/8" - BSW-BSF 5/8"
E011/U20	€ 15,30	M 18 x 2.5 - M 18 x 2.0 - M 18 x 1.5	UNC 3/4" - BSW-BSF 3/4"
E011/U21	€ 15,30	M 20 x 2.5 - M 20 x 2.0 - M 20 x 1.5	UNF 3/4"
E011/U22	€ 19,30	M 22 x 2.5 - M 22 x 2.0 - M 22 x 1.5	UNC/UNF 7/8" - BSW-BSF 7/8"
E011/U23	€ 19,30	M 24 x 3.0 - M 24 x 2.0 - M 24 x 1.5	UNC/UNF 1" - BSW-BSF 1"



E011-UMx

CAT 42

F-COIL MOUNTING TOOL HEXAGONAL DRIVE

Art.	€	Diameter	Hex drive
E011/UM260X150	€ 22,80	M 26 x 1.5 mm	1/2"
E011/UM270X150	€ 22,80	M 27 x 1.5 mm	1/2"
E011/UM270X200	€ 22,80	M 27 x 2.0 mm	1/2"
E011/UM270X300	€ 22,80	M 27 x 3.0 mm	1/2"
E011/UM280X150	€ 22,80	M 28 x 1.5 mm	1/2"
E011/UM300X150	€ 25,40	M 30 x 1.5 mm	1/2"
E011/UM300X200	€ 25,40	M 30 x 2.0 mm	1/2"
E011/UM300X350	€ 25,40	M 30 x 3.5 mm	1/2"
E011/UM330X200	€ 31,50	M 33 x 2.0 mm	1/2"
E011/UM330X350	€ 31,50	M 33 x 3.5 mm	1/2"
E011/UM360X150	€ 31,50	M 36 x 1.5 mm	1/2"
E011/UM360X200	€ 31,50	M 36 x 2.0 mm	1/2"
E011/UM360X300	€ 31,50	M 36 x 3.0 mm	1/2"
E011/UM360X400	€ 31,50	M 36 x 4.0 mm	1/2"



E011-Ax

CAT 42

F-COIL TANG BREAKING TOOL

Art.	€	Metric	Inch
E011/A02	€ 2,20	M 2 x 0.4 - M 2.2 x 0.45	UNC N02
E011/A03	€ 2,20	M 2.5 x 0.45	
E011/A04	€ 2,20	M 3 x 0.5	UNC/UNF N04
E011/A05	€ 2,20	M 3.5 x 0.6	UNC/UNF N06
E011/A06	€ 2,20	M 4 x 0.7	UNC N10 - UNC/UNF N08 - BSF 3/16"
E011/A08	€ 2,20	M 5 x 0.8	UNF N10 - UNC N12 - BSF 3/16"
E011/A09	€ 2,20	M 6 x 1.0	UNC/UNF 1/4" - BSW/BSF 1/4"
E011/A11	€ 2,47	M 7 x 1.0 - M 8 x 1.0 - M 8 x 1.25	UNC/UNF 5/16" - BSW/BSF 5/16"
E011/A12	€ 2,47	M 9 x 1.0 - M 9 x 1.25	UNC 3/8" - BSW/BSF 3/8"
E011/A13	€ 2,47	M 10 x 1.5 - M 10 x 1.0 - M 10 x 1.25	UNF 3/8"
E011/A14	€ 2,98	M 11 x 1.5	UNC/UNF 7/16" - BSW/BSF 7/16"
E011/A15	€ 2,98	M 12 x 1.5 - M 12 x 1.0 - M 12 x 1.25 - M 12 x 1.75	UNC/UNF 1/2" - BSW/BSF 1/2"



E011-Ex

CAT 42

F-COIL PULLER

Art.	€	Metric	Inch
E011/E2	€ 14,20	M 3 - M 10	3/16" - 3/8"
E011/E3	€ 17,30	M 11 - M 10	3/8" - 1"



LBx

CAT 42

BI-METAL BLADE FOR METAL



Art.	€	Sizes	Specifications	Art.	€	Sizes	Specifications	Art.	€	Sizes	Specifications
LB01/1140	€ 14,50	1140 x 13 x 065 mm	T 8 / 12 Bi-Metal	LB08/2000	€ 23,80	2000 x 20 x 09 mm	T 5 / 7 Bi-Metal	LB09/3120	€ 36,80	3120 x 27 x 09 mm	T 8 / 11 Bi-Metal
LB01/1325	€ 16,10	1325 x 13 x 065 mm	T 8 / 12 Bi-Metal	LB08/2080	€ 24,50	2080 x 20 x 09 mm	T 5 / 7 Bi-Metal	LB09/3150	€ 37,00	3150 x 27 x 09 mm	T 8 / 11 Bi-Metal
LB01/1335	€ 16,20	1335 x 13 x 065 mm	T 8 / 12 Bi-Metal	LB08/2100	€ 24,70	2100 x 20 x 09 mm	T 5 / 7 Bi-Metal	LB10/2375	€ 27,30	2375 x 27 x 09 mm	T 5 / 7 Bi-Metal
LB01/1435	€ 17,10	1435 x 13 x 065 mm	T 8 / 12 Bi-Metal	LB08/2140	€ 25,10	2140 x 20 x 09 mm	T 5 / 7 Bi-Metal	LB10/2450	€ 29,20	2450 x 27 x 09 mm	T 5 / 7 Bi-Metal
LB01/1440	€ 17,10	1440 x 13 x 065 mm	T 8 / 12 Bi-Metal	LB08/2160	€ 25,30	2160 x 20 x 09 mm	T 5 / 7 Bi-Metal	LB10/2500	€ 30,30	2500 x 27 x 09 mm	T 5 / 7 Bi-Metal
LB01/1638	€ 18,80	1638 x 13 x 065 mm	T 8 / 12 Bi-Metal	LB09/2375	€ 27,30	2375 x 27 x 09 mm	T 8 / 11 Bi-Metal	LB10/2750	€ 32,90	2750 x 27 x 09 mm	T 5 / 7 Bi-Metal
LB01/1735	€ 19,70	1735 x 13 x 065 mm	T 8 / 12 Bi-Metal	LB09/2450	€ 29,20	2450 x 27 x 09 mm	T 8 / 11 Bi-Metal	LB10/2825	€ 33,70	2825 x 27 x 09 mm	T 5 / 7 Bi-Metal
LB02/1140	€ 14,50	1140 x 13 x 065 mm	T 6 Bi-Metal	LB09/2500	€ 30,30	2500 x 27 x 09 mm	T 8 / 11 Bi-Metal	LB10/2845	€ 33,80	2845 x 27 x 09 mm	T 5 / 7 Bi-Metal
LB02/1435	€ 17,10	1435 x 13 x 065 mm	T 6 Bi-Metal	LB09/2750	€ 32,90	2750 x 27 x 09 mm	T 8 / 11 Bi-Metal	LB10/2945	€ 34,90	2945 x 27 x 09 mm	T 5 / 7 Bi-Metal
LB05/1735	€ 20,30	1735 x 13 x 09 mm	T 8 / 12 Bi-Metal	LB09/2825	€ 33,70	2825 x 27 x 09 mm	T 8 / 11 Bi-Metal	LB10/2950	€ 35,00	2950 x 27 x 09 mm	T 5 / 7 Bi-Metal
LB07/2000	€ 23,80	2000 x 20 x 09 mm	T 8 / 12 Bi-Metal	LB09/2845	€ 33,80	2845 x 27 x 09 mm	T 8 / 11 Bi-Metal	LB10/2950	€ 35,00	2950 x 27 x 09 mm	T 5 / 7 Bi-Metal
LB07/2080	€ 24,50	2080 x 20 x 09 mm	T 8 / 12 Bi-Metal	LB09/2945	€ 34,90	2945 x 27 x 09 mm	T 8 / 11 Bi-Metal	LB10/3010	€ 35,60	3010 x 27 x 09 mm	T 5 / 7 Bi-Metal
LB07/2100	€ 24,70	2100 x 20 x 09 mm	T 8 / 12 Bi-Metal	LB09/2950	€ 35,00	2950 x 27 x 09 mm	T 8 / 11 Bi-Metal	LB10/3100	€ 36,50	3100 x 27 x 09 mm	T 5 / 7 Bi-Metal
LB07/2140	€ 25,10	2140 x 20 x 09 mm	T 8 / 12 Bi-Metal	LB09/3010	€ 35,60	3010 x 27 x 09 mm	T 8 / 11 Bi-Metal	LB10/3120	€ 36,80	3120 x 27 x 09 mm	T 5 / 7 Bi-Metal
LB07/2160	€ 25,30	2160 x 20 x 09 mm	T 8 / 12 Bi-Metal	LB09/3100	€ 36,50	3100 x 27 x 09 mm	T 8 / 11 Bi-Metal	LB10/3150	€ 37,00	3150 x 27 x 09 mm	T 5 / 7 Bi-Metal

07x

WOOD CARBIDE TIPPED SAW BLADES

Art.	€	Ø	Teeth Z	Hole	Cut thickness	Blade thickness	rpm max
0685	€ 25,00	254 mm	24	Ø 30 mm	3,2 mm	2,2 mm	6300
0702	€ 41,80	250 mm	60	Ø 30 mm	3,2 mm	2,2 mm	7000
0703	€ 48,20	250 mm	80	Ø 30 mm	3,2 mm	2,2 mm	7000
0704	€ 61,90	300 mm	72	Ø 30 mm	3,2 mm	2,2 mm	6000
0705	€ 66,80	300 mm	96	Ø 30 mm	3,2 mm	2,2 mm	6000
0899	€ 46,20	315 mm	25	Ø 30 mm	2,8 mm	1,8 mm	6000
0745	€ 75,80	350 mm	54	Ø 30 mm	3,5 mm	2,5 mm	5000
0707	€ 77,00	400 mm	48	Ø 30 mm	3,5 mm	2,5 mm	4500
0746	€ 133,00	450 mm	60	Ø 30 mm	4 mm	3,0 mm	4000



0762-

ALUMINIUM AND PLASTIC CARBIDE TIPPED SAW BLADE

WITH ALTERNATE UNIVERSAL TEETH TO CUT ANY TYPE OF WOOD, MULTI-LAYERS, PLYWOOD, CHIPBOARD AND OTHER MATERIALS

Art.	€	Ø	Teeth Z	Hole	Cut thickness	Blade thickness	rpm max
0762/250	€ 49,40	250 mm	60	Ø 32 mm	3,2 mm	2,8 mm	7000
0762/300	€ 62,30	300 mm	72	Ø 32 mm	3,2 mm	2,8 mm	6000



N7x

BLADE FOR WOOD

BLADE FOR THIN WOOD AND CONTOURED CUTS



Art.	€	Sizes	Specifications
N194	€ 19,70	1400 x 6 x 0.36 mm	T6
N717/N	€ 19,70	1430 x 6 x 0.36 mm	T6
N188	€ 23,30	1790 x 6 x 0.36 mm	T10
N190	€ 23,30	1826 x 6 x 0.36 mm	T10
N855/N2	€ 22,40	2240 x 13 x 0.65 mm	T8
N186	€ 20,00	2400 x 13 x 0.65 mm	T8
N192	€ 20,00	2560 x 13 x 0.65 mm	T8
N764/N2	€ 22,40	2950 x 13 x 0.65 mm	T6
N764/455/N2	€ 31,10	3430 x 16 x 0.65 mm	T6

N7x1

BLADES FOR WOOD

BLADE FOR STRAIGHT CUT OF THICK WOOD







Art.	€	Sizes	Specifications
N195	€ 19,70	1400 x 10 x 0.36 mm	T6
N717/N1	€ 19,70	1430 x 10 x 0.36 mm	T6
N189	€ 23,30	1790 x 10 x 0.36 mm	T6
N191	€ 23,30	1826 x 10 x 0.36 mm	T6
N855/N	€ 22,40	2240 x 16 x 0.65 mm	T4
N187	€ 20,00	2400 x 16 x 0.65 mm	T4
N193	€ 20,00	2560 x 16 x 0.65 mm	T4
N764/N	€ 22,40	2950 x 16 x 0.65 mm	T4
N764/455/N	€ 31,10	3430 x 20 x 0.65 mm	T4









CALIPERS, HEIGHT GAUGE AND RULERS

- pag.262*  — Digital calipers
- pag.262*  — Calipers with dial gauge
- pag.263*  — Vernier calipers
- pag.265*  — Height gauge
- pag.265*  — Steel and digital rules





DIAL INDICATORS

- pag.268*  — Dial indicators
- pag.270*  — Dial thickness gauges
- pag.271*  — Edge finders



MICROMETERS

- pag.272*  — Outside micrometers
- pag.273*  — Inside micrometers







GAUGE BLOCKS, SCREW GAUGE AND HOLE PLAIN GAUGE

- pag.274*  — Gauge blocks
- pag.275*  — Gauges





MEASURING TOOLS

- pag.277*  — Magnetic base
- pag.281*  — Inspection plates
- pag.282*  — Squares
- pag.284*  — Screw pitch gauge







PRECISION TAPES, LEVELS AND GONIOMETERS

- pag.287*  — Precision tapes
- pag.288*  — Levels
- pag.290*  — Protractor





ANALOGIC AND DIGITAL METERS

- pag.291*  — Endoscopes
- pag.292*  — Testers
- pag.294*  — Digital meters
- pag.298*  — Refractometers
- pag.299*  — Hardness testers



SCALES

- pag.301*  — Scales
- pag.302*  — Dinamometers

C031/150

€ 150,00

STAINLESS STEEL ELECTRONIC DIGITAL CALIPER

WITH 2 FUNCTIONS AND A BIG SCREEN



DIN 862 67

Range	0 ÷ 150 mm - 0 ÷ 6 inch
Reading	0,01 mm - 0.0005 inch
Jaws	40 mm
Beam	16 x 3 mm

C041/150

€ 29,10

MONOBLOCK STAINLESS STEEL ELECTRONIC DIGITAL CALIPER

3 FUNCTIONS WITH BIG LCD



Range	0 ÷ 150 mm - 0 ÷ 6 inch
Reading	0,01 mm - 0.0005 inch
Jaws	40 mm
Beam	16 x 3 mm

C047/500

€ 336,00

STAINLESS STEEL ELECTRONIC DIGITAL CALIPER

WITH 4 FUNCTIONS AND BIG DISPLAY, FINE ADJUSTMENT AND LONG JAWS

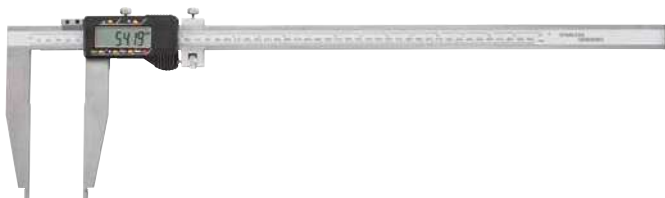

DIN 862

Range	0 ÷ 500 mm - 0 ÷ 20 inch
Reading	0,01 mm - 0.0005 inch
Jaws	150 mm
Beam	24 x 5,5 mm

C033-

STAINLESS STEEL ELECTRONIC DIGITAL CALIPER

WITH 3 FUNCTIONS AND A BIG SCREEN

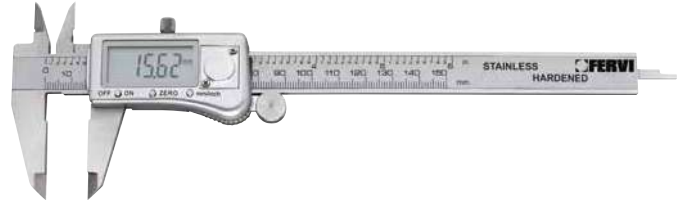

DIN 862 STAINLESS STEEL

Art.	€	Range	Reading	Beam	Jaws
C033/150	€ 51,90	0 ÷ 150 mm - 0 ÷ 6 inch	0,01 mm - 0.0005 inch	16 x 3,2 mm	40 mm
C033/200	€ 75,50	0 ÷ 200 mm - 0 ÷ 8 inch	0,01 mm - 0.0005 inch	16 x 3,2 mm	50 mm
C033/300	€ 112,00	0 ÷ 300 mm - 0 ÷ 12 inch	0,01 mm - 0.0005 inch	16 x 3,2 mm	60 mm

C043-

STAINLESS STEEL ELECTRONIC DIGITAL CALIPER

WITH 4 FUNCTIONS AND BIG LCD, FINE ADJUSTMENT



DIN 862

Art.	€	Range	Reading	Jaws	Beam
C043/500	€ 276,00	0 ÷ 500 mm - 0 ÷ 20 inch	0,01 mm - 0.0005 inch	100 mm	25 x 6 mm
C043/1000	€ 553,00	0 ÷ 1000 mm - 0 ÷ 40 inch	0,01 mm - 0.0005 inch	150 mm	30 x 8 mm

C005/150

€ 45,70

STAINLESS STEEL DIAL CALIPER



DIN 862

Range	0 ÷ 150 mm
Reading	0,01 mm
Jaws	40 mm
Beam	15,5 x 3 mm

C006-

STAINLESS STEEL DIAL CALIPER



DIN 862

Art.	€	Range	Reading	Jaws	Beam
C006/150	€ 40,90	0 ÷ 150 mm	0,02 mm	40 mm	16 x 3 mm
C006/200	€ 62,30	0 ÷ 200 mm	0,02 mm	50 mm	16 x 3 mm
C006/300	€ 101,00	0 ÷ 300 mm	0,02 mm	60 mm	20 x 4 mm

C057/150

€ 17,70

CHROMED VERNIER CALIPER



DIN 862

Range	0 ÷ 150 mm - 0 ÷ 6 inch
Reading	1/20 0,05 mm - 1/128 inch
Jaws	40 mm
Beam	16 x 3 mm

C019/150

€ 14,00

CHROMED VERNIER CALIPER



DIN 862

Range	0 ÷ 150 mm - 0 ÷ 6 inch
Reading	1/20 0,05 mm - 1/128 inch
Jaws	40 mm
Beam	14,5 x 3 mm

C018-

MONOBLOCK STAINLESS STEEL CHROMED VERNIER CALIPER



DIN 862

Art.	€	Range	Reading	Jaws	Beam
C018/150	€ 30,80	0 ÷ 150 mm - 0 ÷ 6 inch	1/20 0,05 mm - 1/128 inch	40 mm	16 x 3 mm
C018/200	€ 47,90	0 ÷ 200 mm - 0 ÷ 8 inch	1/50 0,02 mm - 1/1000 inch	50 mm	16 x 3 mm

C011-

MONOBLOCK STAINLESS STEEL CHROMED VERNIER CALIPER



DIN 862

Art.	€	Range	Reading	Jaws	Beam
C011/150	€ 33,60	0 ÷ 150 mm - 0 ÷ 6 inch	1/50 0,02 mm - 1/1000 inch	40 mm	16 x 3 mm
C011/200	€ 55,60	0 ÷ 200 mm - 0 ÷ 8 inch	1/50 0,02 mm - 1/1000 inch	50 mm	16 x 3 mm

C056/200

€ 24,60

CHROMED VERNIER CALIPER



DIN 862

Range	0 ÷ 200 mm - 0 ÷ 8 inch
Reading	1/50 0,02 mm - 1/1000 inch
Jaws	50 mm
Beam	16,5 x 3,5 mm



C049/300

€ 51,90

CHROMED VERNIER CALIPER

FINE ADJUSTMENT



DIN 862

Range	0 ÷ 300 mm
Reading	1/50 - 0,02 mm
Jaws	60 mm
Beam	18,5 x 4 mm

C020-

CHROMED VERNIER CALIPER

FINE ADJUSTMENT



DIN 862

Art.	€	Range	Reading	Jaws	Beam
C020/500	€ 126,00	0 ÷ 500 mm	1/50 0,02 mm	100 mm	23 x 6 mm
C020/1000	€ 310,00	0 ÷ 1000 mm	1/50 0,02 mm	150 mm	30 x 10 mm
C020/1500	€ 871,00	0 ÷ 1500 mm	1/50 0,02 mm	225 mm	49 x 14 mm
C020/2000	€ 1400,00	0 ÷ 2000 mm	1/50 0,02 mm	250 mm	50 x 15 mm

C007-

CHROMED VERNIER DEPTH GAUGE



DIN 862

Art.	€	Range	Reading	Base	Beam
C007/200	€ 31,70	0 ÷ 200 mm	1/50 0,02 mm	100 mm	9,6 x 4,5 mm
C007/300	€ 43,50	0 ÷ 300 mm	1/50 0,02 mm	100 mm	9,6 x 4 mm

C021-

MONOBLOCK STAINLESS STEEL CHROMED VERNIER CALIPER

FINE ADJUSTMENT



DIN 862

Art.	€	Range	Reading	Jaws	Beam
C021/300	€ 145,00	0 ÷ 300 mm - 0 ÷ 12 inch	1/50 0,02 mm - 1/128 inch	100 mm	23 x 6 mm
C021/500	€ 200,00	0 ÷ 500 mm - 0 ÷ 20 inch	1/50 0,02 mm - 1/128 inch	150 mm	23 x 6 mm
C021/1000	€ 446,00	0 ÷ 1000 mm - 0 ÷ 40 inch	1/50 0,02 mm - 1/128 inch	150 mm	32 x 10 mm

C044-

STAINLESS STEEL ELECTRONIC DIGITAL DEPTH GAUGE

WITH 3 FUNCTIONS WITH BIG DISPLAY



DIN 862

Art.	€	Range	Reading	Base	Beam
C044/200	€ 73,20	0 ÷ 200 mm - 0 ÷ 8 inch	0,01 mm - 0.0005 inch	100 mm	13 x 3,5 mm
C044/300	€ 126,00	0 ÷ 300 mm - 0 ÷ 12 inch	0,01 mm - 0.0005 inch	150 mm	15 x 4 mm

C010/200

€ 45,80

SCRATCH VERNIER CALIPER



C010/200P

€ 6,70

2-BIT SET FOR CALIPER

Range	0 ÷ 200 mm - 0 ÷ 8 inch
Reading	1/10 0,1 mm - 1/128 inch
Jaws	10 mm
Beam	16 x 3 mm

T092-

ELECTRONIC DIGITAL MULTI FUNCTION HEIGHTGAUGE

WITH 4 FUNCTIONS AND BIG DISPLAY, WITH SCRIBER



DIN 862

Art.	€	Range	Reading	Accuracy	Weight
T092/300	€ 461,00	0÷300 mm - 0÷12"	0,01 mm - 0.005"	0,03 mm - 0.015"	4 kg
T092/600	€ 766,00	0÷600 mm - 0÷24"	0,01 mm - 0.005"	0,15 mm - 0.025"	14 kg

T100-

VERNIER HEIGHTGAUGE CHROME PLATED

WITH SCRIBER



DIN 862

Art.	€	Range	Reading	Weight
T100/300	€ 93,60	0 ÷ 300 mm	0,02 mm	3 kg
T100/500	€ 185,00	0 ÷ 500 mm	0,02 mm	6 kg

REAx-FS

STAINLESS STEEL RULE

CAT 42



Stainless steel DIN 1014/32/EU

Art.	€	Length	Stem	Weight
REA0150/FS	€ 2,63	150 mm	13 x 0.5 mm	0.01 kg
REA0300/FS	€ 3,50	300 mm	13 x 0.5 mm	0.02 kg
REA0500/FS	€ 6,10	500 mm	18 x 0.5 mm	0.03 kg
REA1000/FS	€ 14,70	1000 mm	18 x 0.5 mm	0.07 kg

REAx-FD

STAINLESS STEEL RULE

CAT 42



Stainless steel DIN 1014/32/EU

Art.	€	Length	Stem	Weight
REA0150/FD	€ 2,63	150 mm	13 x 0.5 mm	0.01 kg
REA0300/FD	€ 3,50	300 mm	13 x 0.5 mm	0.02 kg
REA0500/FD	€ 6,10	500 mm	18 x 0.5 mm	0.03 kg
REA1000/FD	€ 14,70	1000 mm	18 x 0.5 mm	0.07 kg

REAx-RS

CAT 42

STAINLESS STEEL RULE

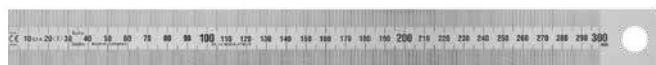

Stainless steel DIN 2014/32/EU

Art.	€	Length	Stem	Weight
REA0300/RS	€ 6,70	300 mm	30 x 1.0 mm	0.07 kg
REA0500/RS	€ 14,00	500 mm	30 x 1.0 mm	0.12 kg
REA1000/RS	€ 26,80	1000 mm	30 x 1.0 mm	0.25 kg
REA2000/RS	€ 49,80	2000 mm	30 x 1.0 mm	0.48 kg

REAx-RD

CAT 42

STAINLESS STEEL RULE



Stainless steel DIN 2014/32/EU

Art.	€	Length	Stem	Weight
REA0300/RD	€ 6,70	300 mm	30 x 1.0 mm	0.07 kg
REA0500/RD	€ 14,00	500 mm	30 x 1.0 mm	0.12 kg
REA1000/RD	€ 26,80	1000 mm	30 x 1.0 mm	0.25 kg
REA2000/RD	€ 49,80	2000 mm	30 x 1.0 mm	0.48 kg

REAx-RS-MID

CAT 42

STAINLESS STEEL RULE MID



Stainless steel DIN 2014/32/UE & MID EC II

Art.	€	Length	Section	Weight
REA0500/RS/MID	€ 16,50	500 mm	30 x 1.0 mm mm ²	0.12 kg
REA1000/RS/MID	€ 32,10	1000 mm	30 x 1.0 mm mm ²	0.25 kg
REA2000/RS/MID	€ 64,20	2000 mm	30 x 1.0 mm mm ²	0.48 kg

REAx-RD-MID

CAT 42

STAINLESS STEEL RULE MID



Stainless steel DIN 2014/32/EU & MID EC II

Art.	€	Length	Stem	Weight
REA0500/RD/MID	€ 16,50	500 mm	30 x 1.0 mm	0.12 kg
REA1000/RD/MID	€ 32,10	1000 mm	30 x 1.0 mm	0.25 kg
REA2000/RD/MID	€ 64,20	2000 mm	30 x 1.0 mm	0.48 kg

RLAx-RS-MID

CAT 42

STAINLESS STEEL RULE MID



Stainless steel DIN 2014/32/EU & MID EC II

Art.	€	Length	Stem	Weight
RLA0500/RS/MID	€ 43,00	500 mm	30 x 1.0 mm	0.12 kg
RLA1000/RS/MID	€ 84,20	1000 mm	30 x 1.0 mm	0.25 kg
RLA2000/RS/MID	€ 169,00	2000 mm	30 x 1.0 mm	0.48 kg

RLAx-RD-MID

CAT 42

STAINLESS STEEL RULE MID



Stainless Steel DIN 2014/32/EU & MID EC II

Art.	€	Length	Stem	Weight
RLA0500/RD/MID	€ 43,00	500 mm	30 x 1.0 mm	0.12 kg
RLA1000/RD/MID	€ 84,20	1000 mm	30 x 1.0 mm	0.25 kg
RLA2000/RD/MID	€ 169,00	2000 mm	30 x 1.0 mm	0.48 kg

REGx-FS

CAT 42

STAINLESS STEEL RULE WITH HOOK 90°

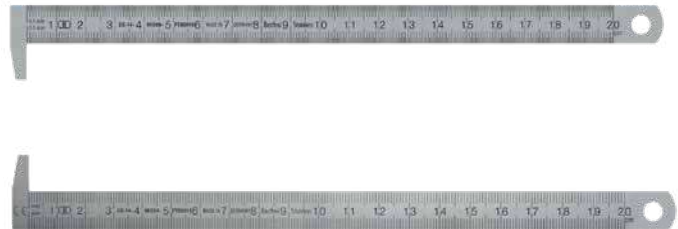

Stainless steel DIN 2014/32/EU

Art.	€	Length	Stem	Weight
REG0200/FS	€ 10,10	200 mm	13 x 0.5 mm	0.01 kg
REG0300/FS	€ 11,50	300 mm	13 x 0.5 mm	0.01 kg
REG0500/FS	€ 22,70	500 mm	18 x 0.5 mm	0.01 kg

Rx

SCALE WITH MULTIFUNCTION DIGITAL READOUT

THE SCALE CAN BE CUT TO REACH THE DESIRED LENGTH FUNCTIONS : ON / OFF - mm / INCH - ZERO - ABS / INC - AUTO POWER OFF



Art.	€	Total length	Range	Reading
R060	€ 69,70	630 mm - 24.8" inch	500 mm - 19.7" inch	0,01 mm - 0.001" inch
R100	€ 91,00	1000 mm - 40" inch	900 mm - 35" inch	0,01 mm - 0.001" inch

C064

€ 91,00

MULTIFUNCTIONAL ELECTRONIC DIGITAL INDICATOR LARGE DISPLAY

FUNCTIONS: ZERO POINT AT ANY POSITION, mm/INCH, CONVERSION, HOLD, MIN, MAX FUNCTIONS, AUTO POWER OFF, BATTERY SR44W



DIN 878

Range	0 ÷ 12,7 mm / 0 ÷ 0.5 inch
Reading	0,01 mm / 0.005 inch
Accuracy	0,02 mm / 0.002 inch
Dial size	60 mm

C004

€ 75,00

DIAL INDICATOR



DIN 878

Dial size	60 mm
Range	0 ÷ 1 mm
Reading	0,001 mm
Accuracy	0,002 mm

C002

€ 45,10

DIAL INDICATOR



DIN 878

Dial size	60 mm
Range	10 mm
Reading	0,01 mm
Accuracy	0,015 mm

C060

€ 191,00

MULTIFUNCTIONAL ELECTRONIC DIGITAL INDICATOR LARGE DISPLAY

FUNCTIONS: ZERO POINT AT ANY POSITION, mm/INCH CONVERSION, HOLD, MIN, MAX FUNCTIONS, AUTO POWER OFF, BATTERY CR 2025



DIN 878 ABS

Range	0 ÷ 12,7 mm / 0 ÷ 0.5 inch
Reading	0,001 mm / 0.0005 inch
Accuracy	0,005 mm / 0.0025 inch
Dial size	60 mm

C017

€ 51,90

SHOCKPROOF AND SPLASHPROOF DIAL INDICATOR

WITH MOVEMENT ON JEWELS, WITH BACK LUG



DIN 878

Dial size	60 mm
Range	10 mm
Reading	0,01 mm
Accuracy	0,015 mm

C023-

DIAL INDICATOR

WITH BACK LUG

C023

C023/N

C023G



DIN 878

Art.	€	Dial size	Range	Reading	Accuracy
C023	€ 26,40	60 mm	10 mm	0,01 mm	0,015 mm
C023G	€ 17,40	60 mm	10 mm	0,01 mm	0,015 mm
C023/N	€ 29,90	60 mm	10 mm	0,01 mm	0,015 mm

C002/42

€ 32,50

DIAL INDICATOR



DIN 878

Dial size	42 mm
Range	5 mm
Reading	0,01 mm
Accuracy	0,015 mm

C048

€ 63,60

DIAL INDICATOR

WITH BACK LUG



DIN 878

Dial size	60 mm
Range	30 mm
Reading	0,01 mm
Accuracy	0,015 mm

T003-

DIAL TEST INDICATOR



DIN 2270

Art.	€	Dial size	Range	Reading	Accuracy	Contact point
T003	€ 80,00	32 mm	0,8 mm	0,01 mm	0,015 mm	Ø 2 mm
T003G	€ 47,50	32 mm	0,8 mm	0,01 mm	0,008 mm	Ø 2 mm

T007-

DIAL TEST INDICATOR



DIN 2270

Art.	€	Dial size	Range	Reading	Accuracy	Contact point
T007	€ 80,80	40 mm	0,8 mm	0,01 mm	0,011 mm	Ø 2 mm
T007G	€ 51,50	40 mm	0,8 mm	0,01 mm	0,008 mm	Ø 2 mm

T006

€ 86,30

DIAL TEST INDICATOR WITH LONG CONTACT POINT



DIN 2270

Dial size	40 mm
Range	0,8 mm
Reading	0,01 mm
Accuracy	0,011 mm
Contact point	Ø 2 mm
Contact point length	29 mm

T005

€ 95,00

DIAL TEST INDICATOR



DIN 2270

Dial size	32 mm
Range	0,2 mm
Reading	0,002 mm
Accuracy	0,005 mm
Contact point	Ø 2 mm



T011

€ 73,20

DIAL TEST INDICATOR



DIN 2270

Dial size	32 mm
Range	0,8 mm
Reading	0,01 mm
Accuracy	0,011 mm
Contact point	∅ 2 mm

A016-

BORE GAUGE SET WITH DIAL INDICATOR



Art.	€	Range	Reading	Depth
A016/6/10	€ 123,00	6 ÷ 10 mm	0,01 mm	40 mm
A016/10/18	€ 127,00	10 ÷ 18 mm	0,01 mm	100 mm
A016/18/35	€ 127,00	18 ÷ 35 mm	0,01 mm	125 mm
A016/35/50	€ 127,00	35 ÷ 50 mm	0,01 mm	150 mm
A016/50/160	€ 127,00	50 ÷ 160 mm	0,01 mm	150 mm
A016/160/250	€ 142,00	160 ÷ 250 mm	0,01 mm	400 mm
A016/250/450	€ 161,00	250 ÷ 450 mm	0,01 mm	400 mm

M062

€ 20,60

DIGITAL DIAL THICKNESS GAUGE



Range	0 ÷ 12 mm - 0 ÷ 0.5 inch
Reading	0,01 mm - 0.0005 inch
Throat depth	20 mm
Accuracy	±0,1 mm - 0.004 inch

M055

€ 54,60

DIAL THICKNESS GAUGE



Range	0 ÷ 10 mm
Reading	0,01 mm
Throat depth	9 ÷ 16 mm

M055/120

€ 83,10

DIAL THICKNESS GAUGE



Range	0 ÷ 10 mm
Reading	0,01 mm
Throat depth	120 mm

C013/10/30

€ 123,00

DIAL INSIDE GAUGE



Range	10 ÷ 30 mm
Depth	50 mm
Anvil	∅ 2,5 x 2 mm
Reading	0,01 mm

C014-
DIAL INSIDE GAUGE



Art.	€	Range	Depth	Anvil	Reading
C014/15/35	€ 123,00	15 ÷ 35 mm	50 mm	Ø 3 x 3 mm	0,01 mm
C014/35/55	€ 123,00	35 ÷ 55 mm	80 mm	Ø 3 x 6 mm	0,01 mm
C014/55/75	€ 123,00	55 ÷ 75 mm	80 mm	Ø 3 x 6 mm	0,01 mm
C014/75/95	€ 123,00	75 ÷ 95 mm	100 mm	Ø 3 x 8 mm	0,01 mm

C016 € 136,00
DIAL DEPTH GAUGE



Range	0 ÷ 110 mm
Dial indicator range	0 ÷ 10 mm
Base dimensions	63 x 17 mm
Reading	0,01 mm
Extensions Pcs	10

A020 € 116,00

ZERO SETTING WITH DIAL INDICATOR WITH MAGNETIC BASE



Zero setting height	50 mm
Reading	0,01 mm
Range	0 ÷ 8 mm

C062 € 32,50

MECHANICAL EDGE FINDER



Shank	Ø 10 mm
Anvil	Ø 4 - 10 mm

C063 € 62,30

ELECTRONIC EDGE FINDER



Shank	Ø 20 mm
Contact point	Ø 10 mm
Total length	100 mm
Weight	100 g
Power	2 x SR44W

C063/L € 76,20

ELECTRONIC EDGE FINDER WITH LED LIGHT AND AUDIBLE BEEP



Shank	Ø 20 mm
Contact point	Ø 10 mm
Total length	160 mm
Weight	120 g
Power	2 x LR1 1.5V

C061
CO-AX INDICATOR WITH POSITIONING ROD

Dial indicator	Ø 40 mm
Max Range	4,9 mm
Reading	0,01 mm
Max speed	800 rpm
Cylindric shank	Ø 10 mm
Straight feelers	3
Bent feelers	3
Feeler length	50 - 100 - 150 mm
Contact point	Ø 3 mm
Scriber point	50 mm

€ 197,00



M021-

ELECTRONIC DIGITAL MICROMETER

FRICITION THIMBLE WITH CARBIDE FACES, FUNCTIONS: ABS/INC, SET, ON/OFF AND mm/INCH



DIN 863

Art.	€	Size	Reading	Accuracy
M021/00/25	€ 79,20	0 ÷ 25 mm - 0 ÷ 1"	0,001 mm - 0.0005"	0,003 mm - 0.00015"
M021/25/50	€ 99,00	25 ÷ 50 mm - 1" ÷ 2"	0,001 mm - 0.0005"	0,003 mm - 0.00015"
M021/50/75	€ 119,00	50 ÷ 75 mm - 2" ÷ 3"	0,001 mm - 0.0005"	0,004 mm - 0.0002"
M021/75/100	€ 139,00	75 ÷ 100 mm - 3" ÷ 4"	0,001 mm - 0.0005"	0,004 mm - 0.0002"

M022-

CHROMED OUTSIDE MICROMETER

WITH BIG 100 STEP GRADUATION THIMBLE WITH CARBIDE FACES AND FRICTION ON THIMBLE



DIN 863

Art.	€	Size	Reading	Accuracy
M022/00/25	€ 58,20	0 ÷ 25 mm	0,01 mm	0,004 mm
M022/25/50	€ 72,40	25 ÷ 50 mm	0,01 mm	0,004 mm
M022/50/75	€ 85,20	50 ÷ 75 mm	0,01 mm	0,005 mm
M022/75/100	€ 97,90	75 ÷ 100 mm	0,01 mm	0,005 mm

M033-

CHROMED OUTSIDE MICROMETER

WITH CARBIDE FACES AND PAINTED FRAME



DIN 863

Art.	€	Size	Reading	Spindle
M033/00/25	€ 21,30	0÷25 mm	0,01 mm	ø 6,3 mm
M033/25/50	€ 29,90	25÷50 mm	0,01 mm	ø 6,3 mm
M033/50/75	€ 33,40	50÷75 mm	0,01 mm	ø 6,3 mm
M033/75/100	€ 37,00	75÷100 mm	0,01 mm	ø 6,3 mm

M026-

ELECTRONIC DIGITAL MICROMETER

FRICITION THIMBLE WITH CARBIDE FACES



DIN 863

Art.	€	Size	Reading	Accuracy
M026/0/25	€ 154,00	0 ÷ 25 mm - 0 ÷ 1"	0,001 mm - 0.0001"	0,0002 mm - 0.00008"
M026/25/50	€ 192,00	25 ÷ 50 mm - 1 ÷ 2"	0,001 mm - 0.0001"	0,0002 mm - 0.00008"
M026/50/75	€ 207,00	50 ÷ 75 mm - 2 ÷ 3"	0,001 mm - 0.0001"	0,0003 mm - 0.00012"
M026/75/100	€ 229,00	75 ÷ 100 mm - 3 ÷ 4"	0,001 mm - 0.0001"	0,0003 mm - 0.00012"

M033

€ 169,00

OUTSIDE MICROMETER SET

WITH CARBIDE FACES AND PAINTED FRAME



DIN 863

Size	0÷25 - 25÷50 - 50÷75 - 75÷100 - 100÷125 - 125÷150 mm
Reading	0,01 mm
Accuracy	0,004 - 0,004 - 0,005 - 0,005 - 0,006 - 0,006 mm
Rail	ø 6,3 mm

M033-x

CHROMED OUTSIDE MICROMETER

WITH CARBIDE FACES AND PAINTED FRAME



DIN 863

Art.	€	Size	Reading	Spindle
M033/100/125	€ 39,60	100÷125 mm	0,01 mm	ø 6,3 mm
M033/125/150	€ 42,20	125÷150 mm	0,01 mm	ø 6,3 mm
M033/150/175	€ 50,50	150÷175 mm	0,01 mm	ø 6,3 mm
M033/175/200	€ 57,50	175÷200 mm	0,01 mm	ø 6,3 mm
M033/200/225	€ 66,70	200÷225 mm	0,01 mm	ø 6,3 mm
M033/225/250	€ 81,50	225÷250 mm	0,01 mm	ø 6,3 mm
M033/250/275	€ 83,90	250÷275 mm	0,01 mm	ø 6,3 mm
M033/275/300	€ 94,20	275÷300 mm	0,01 mm	ø 6,3 mm

M009-

CHROMED OUTSIDE MICROMETER

WITH CARBIDE FACES AND PAINTED FRAME



DIN 863

Art.	€	Size	Reading	Spindle
M009/300/400	€ 290,00	300 ÷ 400 mm	0,01 mm	ø 6,5 mm
M009/400/500	€ 317,00	400 ÷ 500 mm	0,01 mm	ø 6,5 mm
M009/500/600	€ 366,00	500 ÷ 600 mm	0,01 mm	ø 6,5 mm
M009/600/700	€ 435,00	600 ÷ 700 mm	0,01 mm	ø 6,5 mm
M009/700/800	€ 522,00	700 ÷ 800 mm	0,01 mm	ø 6,5 mm
M009/800/900	€ 603,00	800 ÷ 900 mm	0,01 mm	ø 6,5 mm
M009/900/1000	€ 716,00	900 ÷ 1000 mm	0,01 mm	ø 6,5 mm
M009/1000/1200	€ 1060,00	1000 ÷ 1200 mm	0,01 mm	ø 6,5 mm

M019-

BLIND HOLE THREE POINT INSIDE MICROMETER

BLIND HOLE THREE POINT INSIDE MICROMETER



Art.	€	Ring	Size	Reading	Accuracy
M019/06/08	€ 324,00	1	6 ÷ 8 mm	0,001 mm	0,004 mm
M019/08/10	€ 324,00	1	8 ÷ 10 mm	0,001 mm	0,004 mm
M019/10/12	€ 324,00	1	10 ÷ 12 mm	0,001 mm	0,004 mm
M019/12/16	€ 303,00	1	12 ÷ 16 mm	0,005 mm	0,004 mm
M019/16/20	€ 303,00	1	16 ÷ 20 mm	0,005 mm	0,004 mm
M019/20/25	€ 325,00	1	20 ÷ 25 mm	0,005 mm	0,004 mm
M019/25/30	€ 325,00	1	25 ÷ 30 mm	0,005 mm	0,004 mm
M019/30/40	€ 358,00	1	30 ÷ 40 mm	0,005 mm	0,004 mm
M019/40/50	€ 427,00	1	40 ÷ 50 mm	0,005 mm	0,005 mm
M019/50/63	€ 435,00	1	50 ÷ 63 mm	0,005 mm	0,005 mm
M019/62/75	€ 482,00	1	62 ÷ 75 mm	0,005 mm	0,005 mm
M019/75/88	€ 488,00	1	75 ÷ 88 mm	0,005 mm	0,005 mm
M019/87/100	€ 488,00	1	87 ÷ 100 mm	0,005 mm	0,005 mm
M019/100/125	€ 543,00	0	100 ÷ 125 mm	0,005 mm	0,005 mm
M019/125/150	€ 599,00	0	125 ÷ 150 mm	0,005 mm	0,005 mm

M013/0/100

€ 103,00

DEPTH MICROMETER

Range	0 ÷ 25 mm, 25 ÷ 50 mm, 50 ÷ 75 mm, 75 ÷ 100 mm
Reading	0,01 mm
Base	100 x 17 mm



M010-

DISC MICROMETER

PAINTED FRAME

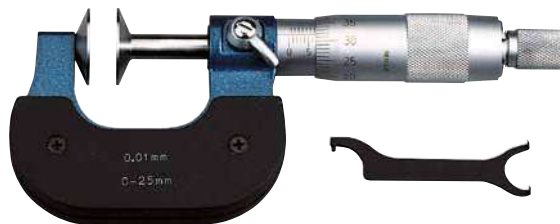

DIN 863

Art.	€	Size	Reading	Discs
M010/0/25	€ 91,00	0 ÷ 25 mm	0,01 mm	Ø 20 mm
M010/25/50	€ 112,00	25 ÷ 50 mm	0,01 mm	Ø 20 mm
M010/50/75	€ 118,00	50 ÷ 75 mm	0,01 mm	Ø 20 mm
M010/75/100	€ 124,00	75 ÷ 100 mm	0,01 mm	Ø 20 mm
M010/100/125	€ 158,00	100 ÷ 125 mm	0,01 mm	Ø 27 mm
M010/125/150	€ 179,00	125 ÷ 150 mm	0,01 mm	Ø 27 mm
M010/150/175	€ 199,00	150 ÷ 175 mm	0,01 mm	Ø 27 mm
M010/175/200	€ 210,00	175 ÷ 200 mm	0,01 mm	Ø 27 mm

M019-x

BLIND HOLE THREE POINT INSIDE MICROMETER SET



Art.	€	Micrometers	Rings	Size	Reading	Accuracy
M019/06/12	€ 842,00	3	3	6 ÷ 12 mm	0,001 mm	0,004 mm
M019/12/20	€ 459,00	2	1	12 ÷ 20 mm	0,005 mm	0,004 mm
M019/20/40	€ 893,00	3	2	20 ÷ 40 mm	0,005 mm	0,004 mm
M019/40/100	€ 1970,00	5	3	40 ÷ 100 mm	0,005 mm	0,005 mm



B0x
METRIC GAUGE BLOCK SET

INSPECTION CERTIFICATE ISSUED BY THE FACTORY, SIT CERTIFICATE UPON REQUEST

DIN 863

Art.	€	Grade	Nr. blocks	Nominal size	Increment	Pcs by step
B011/0	€ 174,00	0	11	2,5 - 5,1 - 7,7 - 10,3 - 12,9 - 15 - 17,6 - 20,2 - 22,8 - 23,4 - 25 mm	mm	1
B032/1	€ 218,00	1	32	1,005 1,01±1,09 1,1±1,9 1 ÷ 9 10 - 20 - 30 - 50 mm	- 0,01 0,1 1 mm	1 9 9 9 4
B047/0	€ 500,00	1	47	1,005 1,01±1,2 1,3±1,9 1 ÷ 9 10 ÷ 100 mm	- 0,01 0,1 1 10 mm	1 20 7 9 10
B047/1	€ 296,00	1	87	1,001±1,009 1,01±1,49 0,5÷9,5 10÷100 mm	0,001 0,01 0,5 10 mm	9 49 19 10
B087/0	€ 832,00	0	47	1,005 1,01±1,2 1,3±1,9 1 ÷ 9 10 ÷ 100 mm	- 0,01 0,1 1 10 mm	1 20 7 9 10
B087/1	€ 446,00	1	112	1,005 1,001 ± 1,009 1,01 ± 1,49 0,5 ÷ 24,5 25 - 50 - 75 - 100 mm	- 0,001 0,01 0,5 25 mm	1 9 49 49 4
B112/0	€ 838,00	0	87	1,001±1,009 1,01±1,49 0,5÷9,5 10÷100 mm	0,001 0,01 0,5 10 mm	9 49 19 10
B112/1	€ 591,00	0	112	1,005 1,001 ± 1,009 1,01 ± 1,49 0,5 ÷ 24,5 25 - 50 - 75 - 100 mm	- 0,001 0,01 0,5 25 mm	1 9 49 49 4
B008/1	€ 842,00	1	8	25 - 50 - 75 - 100 - 250 - 300 - 400 - 500 mm		1

C025-

H7 HOLE PLAIN GAUGE WITH "GO" & "NO GO" CHECKS MADE OF HARDENED ALLOY STEEL

Art.	€	∅	Pieces
C025/03	€ 28,10	3 mm	1
C025/04	€ 28,10	4 mm	1
C025/05	€ 28,10	5 mm	1
C025/06	€ 28,10	6 mm	1
C025/07	€ 28,10	7 mm	1
C025/08	€ 28,10	8 mm	1
C025/09	€ 28,10	9 mm	1
C025/10	€ 28,10	10 mm	1
C025/11	€ 34,80	11 mm	1
C025/12	€ 34,80	12 mm	1
C025/13	€ 34,80	13 mm	1
C025/14	€ 34,80	14 mm	1
C025/15	€ 34,80	15 mm	1
C025/16	€ 34,80	16 mm	1
C025/17	€ 34,80	17 mm	1
C025/18	€ 34,80	18 mm	1
C025/19	€ 34,80	19 mm	1
C025/20	€ 34,80	20 mm	1
C025/21	€ 52,10	21 mm	1
C025/22	€ 52,10	22 mm	1
C025/23	€ 52,10	23 mm	1
C025/24	€ 52,10	24 mm	1
C025/25	€ 52,10	25 mm	1
C025/26	€ 52,10	26 mm	1
C025/27	€ 52,10	27 mm	1
C025/28	€ 52,10	28 mm	1
C025/29	€ 52,10	29 mm	1
C025/30	€ 65,30	30 mm	1
C025/32	€ 65,30	32 mm	1
C025/33	€ 65,30	33 mm	1
C025/34	€ 65,30	34 mm	1
C025/35	€ 65,30	35 mm	1
C025/36	€ 65,30	36 mm	1
C025/37	€ 65,30	37 mm	1

Art.	€	∅	Pieces
C025/38	€ 65,30	38 mm	1
C025/40	€ 65,30	40 mm	1
C025/42	€ 65,30	42 mm	1
C025/44	€ 65,30	44 mm	1
C025/45	€ 73,40	45 mm	1
C025/46	€ 73,50	46 mm	1
C025/47	€ 73,50	47 mm	1
C025/48	€ 73,50	48 mm	1
C025/50	€ 73,50	50 mm	1
C025/51	€ 78,80	51 mm	2
C025/52	€ 78,80	52 mm	2
C025/55	€ 78,80	55 mm	2
C025/56	€ 78,80	56 mm	2
C025/57	€ 78,80	57 mm	2
C025/58	€ 78,80	58 mm	2
C025/59	€ 78,80	59 mm	2
C025/60	€ 78,80	60 mm	2
C025/62	€ 95,30	62 mm	2
C025/63	€ 95,30	63 mm	2
C025/65	€ 95,30	65 mm	2
C025/66	€ 95,30	66 mm	2
C025/67	€ 95,30	67 mm	2
C025/68	€ 95,30	68 mm	2
C025/69	€ 95,30	69 mm	2
C025/70	€ 126,00	70 mm	2
C025/71	€ 126,00	71 mm	2
C025/72	€ 126,00	72 mm	2
C025/74	€ 126,00	74 mm	2
C025/75	€ 126,00	75 mm	2
C025/76	€ 126,00	76 mm	2
C025/78	€ 126,00	78 mm	2
C025/80	€ 126,00	80 mm	2



C025-3x

H7 HOLE PLAIN GAUGE SET "GO" & "NO GO"



Art.	€	Pieces	Pitch	∅
C025/3/30	€ 884,00	28	1 mm	3 ÷ 30 mm
C025/32/62	€ 1060,00	16	-	32-35-37-38-40-42-45-47-48-50-52-55-56-58-60-62 mm

A015-

RING GAUGE FOR ZERO SETTING

6G ACCURACY



DIN 2250

Art.	€	Size
A015/008	€ 42,50	8 mm
A015/010	€ 47,70	10 mm
A015/011	€ 47,70	11 mm
A015/017	€ 52,10	17 mm
A015/025	€ 52,10	25 mm
A015/035	€ 52,10	35 mm
A015/040	€ 88,70	40 mm
A015/062	€ 98,00	62 mm
A015/087	€ 232,00	87 mm
A015/100	€ 244,00	100 mm
A015/125	€ 378,00	125 mm
A015/150	€ 530,00	150 mm

T048x
THREAD PLUG GAUGE "GO" & "NO GO"

CYLINDRIC BSP



ISO 228/1

Art.	€	Dimensions
T0481/8	€ 52,80	1/8" - 28 TPI
T0481/4	€ 52,80	1/4" - 19 TPI
T0483/8	€ 52,80	3/8" - 19 TPI
T0481/2	€ 68,00	1/2" - 14 TPI
T0485/8	€ 79,30	5/8" - 14 TPI
T0483/4	€ 84,70	3/4" - 14 TPI
T0487/8	€ 110,00	7/8" - 14 TPI
T0481	€ 129,00	1" - 11 TPI

A018x
"GO" SCREW GAUGE

"GO" SCREW GAUGE, CYLINDRIC BSP



ISO 228/1

Art.	€	Dimensions
A0181/8	€ 54,50	1/8" - 28 TPI
A0181/4	€ 54,50	1/4" - 19 TPI
A0183/8	€ 54,50	3/8" - 19 TPI
A0181/2	€ 74,70	1/2" - 14 TPI
A0185/8	€ 74,70	5/8" - 14 TPI
A0183/4	€ 90,70	3/4" - 14 TPI
A0187/8	€ 110,00	7/8" - 14 TPI
A0181	€ 80,00	1" - 11 TPI

T049x
6H "GO" & "NO GO" ISOMETRIC THREAD PLUG GAUGE

Art.	€	Dimensions
T0493X0.5	€ 48,40	3 x 0,5 mm
T0494X0.7	€ 62,30	4 x 0,7 mm
T0495X0.8	€ 64,50	5 x 0,8 mm
T0496X1	€ 64,50	6 x 1 mm
T0498X1	€ 58,70	8 x 1 mm
T0498X1.25	€ 58,70	8 x 1,25 mm
T04910X1	€ 60,10	10 x 1 mm
T04910X1.25	€ 60,10	10 x 1,25 mm
T04910X1.5	€ 60,10	10 x 1,5 mm
T04912X1.25	€ 60,10	12 x 1,25 mm
T04912X1.5	€ 60,10	12 x 1,5 mm
T04912X1.75	€ 60,10	12 x 1,75 mm
T04914X1.5	€ 64,50	14 x 1,5 mm
T04914X2	€ 64,50	14 x 2 mm
T04916X1.5	€ 67,30	16 x 1,5 mm
T04916X2	€ 67,30	16 x 2 mm
T04918X1.5	€ 50,00	18 x 1,5 mm
T04918X2.5	€ 50,00	18 x 2,5 mm
T04920X1.5	€ 54,70	20 x 1,5 mm
T04920X2.5	€ 54,70	20 x 2,5 mm
T04922X1.5	€ 56,00	22 x 1,5 mm
T04922X2.5	€ 56,00	22 x 2,5 mm
T04924X1.5	€ 58,70	24 x 1,5 mm
T04924X2	€ 58,70	24 x 2 mm
T04924X3	€ 58,70	24 x 3 mm

A017x
6G "GO" ISOMETRIC SCREW GAUGE

Art.	€	Dimensions
A0173X0.5	€ 46,90	3 x 0,5 mm
A0174X0.7	€ 52,80	4 x 0,7 mm
A0175X0.8	€ 52,80	5 x 0,8 mm
A0176X1	€ 44,00	6 x 1 mm
A0178X1	€ 44,00	8 x 1 mm
A0178X1.25	€ 44,00	8 x 1,25 mm
A01710X1	€ 62,30	10 x 1 mm
A01710X1.25	€ 48,40	10 x 1,25 mm
A01710X1.5	€ 48,40	10 x 1,5 mm
A01712X1.25	€ 67,30	12 x 1,25 mm
A01712X1.5	€ 67,30	12 x 1,5 mm
A01712X1.75	€ 67,30	12 x 1,75 mm
A01714X1.5	€ 67,30	14 x 1,5 mm
A01714X2	€ 67,30	14 x 2 mm
A01716X1.5	€ 71,30	16 x 1,5 mm
A01716X2	€ 71,30	16 x 2 mm
A01718X1.5	€ 50,00	18 x 1,5 mm
A01718X2.5	€ 50,00	18 x 2,5 mm
A01720X1.5	€ 52,70	20 x 1,5 mm
A01720X2.5	€ 52,70	20 x 2,5 mm
A01722X1.5	€ 60,00	22 x 1,5 mm
A01722X2.5	€ 60,00	22 x 2,5 mm
A01724X1.5	€ 80,00	24 x 1,5 mm
A01724X2	€ 80,00	24 x 2 mm
A01724X3	€ 80,00	24 x 3 mm

S091-
STEEL PLUG GAUGE SET

Art.	€	Pieces	Size	Increment	Length	Hardness	Accuracy
S091	€ 388,00	91	1÷10 mm	0,1 mm	50 mm	HRC-60-62	±0,002 mm
S091/61	€ 288,00	61	10÷16 mm	0,1 mm	50 mm	HRC-60-62	±0,002 mm



T009

€ 26,40

DIAL INDICATOR HOLDER



Shank	Ø 8 mm
Female junction	Ø 4 mm

B201/2

€ 16,30

MAGNETIC BASE

N35 MAGNETIC MATERIAL, ABS SWITCH AND PRISMATIC BASE



Base dimensions	60 x 50 x 55 mm
Hole	M8 x 1,25
Hold capacity	800 N
Weight	1 kg

B201/4

€ 30,00

MAGNETIC BASE

N35 MAGNETIC MATERIAL, ABS SWITCH AND PRISMATIC BASE



Base dimensions	117 x 50 x 55 mm
Hole	M8 x 1,25
Hold capacity	1300 N
Weight	2 kg

B201/1

€ 13,70

MAGNETIC BASE

N35 MAGNETIC MATERIAL, ABS SWITCH AND PRISMATIC BASE



Base dimensions	36 x 30 x 35 mm
Hole	M5 x 0,8
Hold capacity	300 N
Weight	0,2 kg

B201/3

€ 21,50

MAGNETIC BASE

N35 MAGNETIC MATERIAL, ABS SWITCH AND PRISMATIC BASE



Base dimensions	73 x 50 x 55 mm
Hole	M8 x 1,25
Hold capacity	1000 N
Weight	1,25 kg

B100

€ 19,60

MAGNETIC STAND

ABS SWITCH AND PRISMATIC BASE



Overall sizes	63 x 50 x 55h mm
Hole	M 8 x 1,25
Magnetic force	600 N



S052/2

€ 25,80

MAGNETIC STAND

WITH MICROMETRIC ADJUSTMENT, STURDY COLUMN AND ADJUSTABLE ARM.
MAGNETIC BASE WITH PRISMATIC SUPPORT AND SWITCH



Main stem	ø 12 x 176 mm
Assistant stem	ø 10 x 150 mm
Magnetic force	800 N
Base dimensions	60 x 50 x 55 mm
Weight	1,5 kg

S052/3

€ 44,60

MAGNETIC STAND

WITH MICROMETRIC ADJUSTMENT, STURDY COLUMN AND ADJUSTABLE ARM.
MAGNETIC BASE WITH PRISMATIC SUPPORT AND SWITCH



Main stem	ø 16 x 225 mm
Assistant stem	ø 14 x 165 mm
Magnetic force	1000 N
Base dimensions	73 x 50 x 55 mm
Weight	2 kg

S052/4

€ 66,10

MAGNETIC STAND

WITH MICROMETRIC ADJUSTMENT, STURDY COLUMN AND ADJUSTABLE ARM.
MAGNETIC BASE WITH PRISMATIC SUPPORT AND SWITCH



Main stem	ø 20 x 355 mm
Assistant stem	ø 14 x 210 mm
Magnetic force	1300 N
Base dimensions	117 x 50 x 55 mm
Weight	3 kg

S049

€ 29,10

MAGNETIC STAND

WITH MICROADJUSTMENT



Main stem	ø 12 x 170 mm
Assistant stem	ø 10 x 150 mm
Magnetic force	600 N
Base dimensions	63 x 50 x 55h mm

S047

€ 54,50

MAGNETIC STAND

WITH MICROADJUSTMENT



Main stem	ø 16 x 220 mm
Assistant stem	ø 12 x 180 mm
Magnetic force	800 N
Base dimensions	65 x 50 x 55h mm

S054

€ 26,40

MAGNETIC STAND



Main stem	ø 12 x 170 mm
Assistant stem	ø 10 x 140 mm
Magnetic force	600 N
Base dimensions	63 x 50 x 55h mm



S055

€ 51,40

MAGNETIC STAND



Main stem	Ø 16 x 210 mm
Assistant stem	Ø 12 x 175 mm
Magnetic force	800 N
Base dimensions	75 x 50 x 55h mm

S042/1

€ 47,50

UNIVERSAL MECHANICAL ARM STAND

WITH 3D CENTRAL LOCK



Base dimensions	36 x 30 x 35 mm
Magnetic force	300 N
Arm length	145 mm
Weight	0,5 kg

S042/2

€ 60,10

UNIVERSAL MECHANICAL ARM STAND

WITH MICROMETRIC ADJUSTMENT AND 3D CENTRAL LOCK



Base dimensions	60 x 50 x 55 mm
Magnetic force	800 N
Arm length	290 mm
Weight	1,4 kg

S042/3

€ 77,30

UNIVERSAL MECHANICAL ARM STAND

WITH MICROMETRIC ADJUSTMENT AND 3D CENTRAL LOCK



Base dimensions	75 x 50 x 55 mm
Magnetic force	1000 N
Arm length	365 mm
Weight	1,7 kg



S045

€ 61,00

UNIVERSAL MECHANICAL ARM STAND



Main stem	Ø 12 x 160 mm
Assistant stem	Ø 10 x 180 mm
Magnetic force	600 N
Base dimensions	63 x 50 x 55h mm

S046

€ 93,40

HYDRAULIC UNIVERSAL MAGNETIC STAND



Main stem	Ø 12 x 180 mm
Assistant stem	Ø 10 x 200 mm
Magnetic force	600 N
Base dimensions	63 x 50 x 55h mm

S041/1

€ 38,60

MINI MAGNETIC STAND

FOR DIAL INDICATOR, WITH FLAT SUPPORT SURFACE AND OPTIMAL ADHESION.



Base dimensions	73 x 37 x 12 mm
Hold capacity	200 N
Weight	0,16 kg

S041/2

€ 57,50

MINI MAGNETIC STAND

WITH PRISMATIC BASE, SUITABLE FOR DIAL INDICATOR, OPTIMAL ADHESION.



Base dimensions	73 x 37 x 26 mm
Hold capacity	200 N
Weight	0,3 kg

B025

€ 180,00

DIAL GAUGE STAND

WITH GROOVED STEEL PLATE AND GRANITE BASE



Dial stand	ø 8 mm
Table dimensions	80 x 80 mm
Base dimensions	150 x 100 mm
Column	ø 25 x 180 mm
Weight	3,8 kg

B010

€ 222,00

DIAL GAUGE STAND

WITH GRANITE BASE



Dial stand	ø 8 mm
Base dimensions	300 x 200 x 50h mm
Column	ø 35 x 300 mm
Base flatness	0,002 mm
Weight	13 kg

A019-

ECCENTRIC BENCH TESTER

WITH DIAL STAND

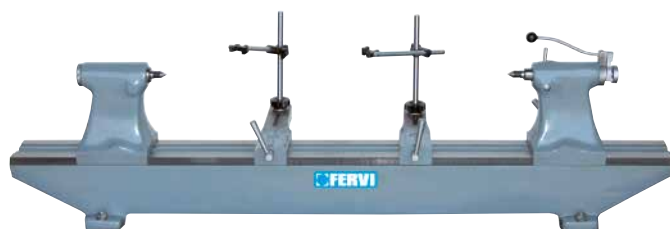

Cast iron

Art.	€	Distance between centers	Centers height Min. - Max	MT	Dimensions	Weight	Dial stand
A019/300	€ 1010,00	300 mm	145 / 175 mm	2	730 x 310 x 370h mm	43 kg	2
A019/500	€ 1290,00	500 mm	135 / 170 mm	2	924 x 330 x 482h mm	86 kg	2
A019/1000	€ 1520,00	1000 mm	135 / 170 mm	2	1400 x 330 x 430h mm	104 kg	2

S051

€ 26,00

MICROMETER STAND

WITH PLASTIC COVERED JAWS



CAST IRON

P04x

GRANITE INSPECTION PLATE

GRADE 00



DIN 876

Art.	€	Dimensions	Weight
P040	€ 72,40	310 x 230 x 80 mm	21 kg
P042	€ 232,00	630 x 400 x 100 mm	87 kg
P043	€ 622,00	1000 x 630 x 150 mm	322 kg
P047	€ 1030,00	1200 x 800 x 160 mm	497 kg
P044	€ 2180,00	1600 x 1000 x 200 mm	1059 kg

S06x

GRANITE SQUARE

GRADE 0



DIN 876

Art.	€	Dimensions	Accuracy
S061	€ 345,00	250 x 40 x 400h mm	± 6 µm
S062	€ 487,00	400 x 100 x 600h mm	± 9 µm

A009

€ 603,00

GAUGE BLOCK ACCESSORIES



15 Pcs

Holding device	n° 3 (50-100-200 mm)
Radius jaw couple	n° 3 (2°- 5°-10°)
Scriber	n° 1
Center point	n° 1
Straight jaws	n° 2 (100 mm)
Couple large diam. jaws	n° 1

B040-

GRANITE SURFACE STAND WITH TWO DRAWERS



Art.	€	Base dimensions	Plate Dimensions	Weight
B040/1	€ 730,00	945 x 590 mm	1000 x 630 mm	66 kg
B040/2	€ 815,00	1200 x 750 mm	1200 x 800 - 1600 x 1000 mm	77 kg

S050-

90° SQUARE

WITH BACK



STEEL DIN 875/1

Art.	€	Dimensions	Section
S050/150	€ 27,70	150 x 100 mm	25,5 x 4,8 mm ²
S050/200	€ 35,20	200 x 130 mm	28 x 6,5 mm ²
S050/250	€ 47,00	250 x 160 mm	31 x 9 mm ²
S050/300	€ 52,30	300 x 200 mm	36 x 9 mm ²
S050/400	€ 116,00	400 x 265 mm	39 x 9 mm ²
S050/500	€ 139,00	500 x 330 mm	50 x 9 mm ²

S051-

90° SQUARE

WITH BACK, CHEAP TYPE



STEEL

Art.	€	Dimensions	Section
S051/150	€ 16,50	150 x 100 mm	20 x 5,5 mm ²
S051/200	€ 18,90	200 x 130 mm	20 x 5,5 mm ²
S051/250	€ 22,30	250 x 160 mm	25 x 5,5 mm ²
S051/300	€ 27,90	300 x 175 mm	25 x 5,5 mm ²
S051/400	€ 30,90	400 x 200 mm	29,5 x 5,5 mm ²
S051/500	€ 32,40	500 x 250 mm	29,5 x 5,5 mm ²

0286-

YELLOW PAINTED JOINER SQUARE



Art.	€	Dimensions
0286/250	€ 2,34	250 x 130 x 0,8 mm
0286/300	€ 2,76	300 x 130 x 0,8 mm
0286/350	€ 3,07	350 x 155 x 0,8 mm

0132-

BEVEL SQUARE

CAT 42



Art.	€	Blade length	Blade section	Handle section	Weight
0132/200	€ 16,50	200 mm	29 x 1.6 mm	30 x 11.5 mm	0.22 kg
0132/250	€ 17,80	250 mm	29 x 1.6 mm	30 x 11.5 mm	0.25 kg
0132/300	€ 19,30	300 mm	29 x 1.6 mm	30 x 11.5 mm	0.28 kg

S048-

STAINLESS STEEL 90° KNIFE EDGE SQUARE



DIN 875/00

Art.	€	Dimensions	Section
S048/100	€ 29,40	100 x 70 mm	20 x 5 mm ²
S048/150	€ 44,60	150 x 100 mm	25 x 5 mm ²

0129-

CARPENTER TRY SQUARE

CAT 42



Aluminium

Art.	€	Blade length	Blade section	Handle length	Handle section	Weight
0129/150	€ 17,40	150 mm	40 x 2 mm	130 mm	40 x 12 mm	0.19 kg
0129/200	€ 17,80	200 mm	40 x 2 mm	130 mm	40 x 12 mm	0.20 kg
0129/250	€ 19,00	250 mm	40 x 2 mm	145 mm	40 x 12 mm	0.21 kg
0129/300	€ 20,30	300 mm	40 x 2 mm	145 mm	40 x 12 mm	0.22 kg
0129/400	€ 24,50	400 mm	40 x 2 mm	170 mm	40 x 12 mm	0.24 kg
0129/500	€ 26,70	500 mm	40 x 2 mm	170 mm	40 x 12 mm	0.26 kg

0139-

MITRE SQUARE

CAT 42



Aluminium

Art.	€	Blade length	Blade section	Handle section	Angle	Weight
0139/250	€ 18,10	250 mm	40 x 2 mm	40 x 12 mm	45° / 135°	0.22 kg
0139/300	€ 19,10	300 mm	40 x 2 mm	40 x 12 mm	45° / 135°	0.24 kg

S056-
90° MAGNETIC SQUARE



Art.	€	Dimensions	Max. magnetic force	Weight
S056/150	€ 68,00	150 x 150 x 50 mm	500 N	2,2 kg
S056/200	€ 85,00	200 x 200 x 50 mm	1000 N	3,2 kg

S057/125 € 15,80
WELDING HOLDER



Overall sizes	135 x 135 x 25 mm
Hold capacity	340 N
Hold working angle	45 - 90 - 135°
Weight	1,1 kg

0212 € 6,60
FEELER



Feelers num.	20
Sizes	0,05 - 1,00 mm

S058 € 78,40
TITLTABLE MAGNETIC SQUARE



Dimensions	115 x 115 x 35 mm
Degrees	45° ÷ 90°
Max. magnetic force	250 N
Weight	1,5 kg

S057/060S € 10,70
MINI WELDING HOLDER



4 Pcs

Overall sizes	50 x 60 x 12,5 mm
Hold capacity	45 N
Hold working angle	45 - 90 - 135°
Weight	0,4 kg



FGx

CAT 42

FEELER GAUGE SET

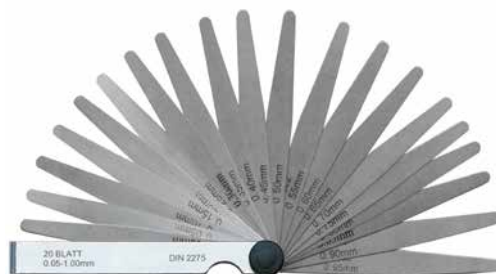

Harmonic steel

Art.	€	Feelers num.	Sizes	Blade length	Weight
FG01	€ 3,65	13	0.05 - 1.00 mm 0.002 - 0.040"	100 mm	0.07 kg
FG02	€ 6,20	20	0.05 - 1.00 mm 0.002 - 0.040"	100 mm	0.10 kg

FGx-AI

CAT 42

FEELER GAUGE SET, STAINLESS STEEL



Stainless steel

Art.	€	Feelers num.	Sizes	Blade length	Weight
FG01/AI	€ 10,80	13	0.05 - 1.00 mm 0.002 - 0.040"	100 mm	0.07 kg
FG02/AI	€ 17,30	20	0.05 - 1.00 mm 0.002 - 0.040"	100 mm	0.10 kg

TGx-AE

CAT 42

THICKNESS GAUGE FOIL



Harmonic steel

Art.	€	Thickness	Length	Weight	Art.	€	Thickness	Length	Weight
TG001/AE	€ 50,30	0.01 mm 0.0004"	5 m	0.04 kg	TG055/AE	€ 22,30	0.55 mm 0.022"	5 m	0.36 kg
TG002/AE	€ 39,00	0.02 mm 0.0008"	5 m	0.04 kg	TG060/AE	€ 22,30	0.60 mm 0.024"	5 m	0.37 kg
TG003/AE	€ 21,50	0.03 mm 0.0012"	5 m	0.05 kg	TG065/AE	€ 22,30	0.65 mm 0.026"	5 m	0.43 kg
TG004/AE	€ 22,30	0.04 mm 0.0016"	5 m	0.05 kg	TG070/AE	€ 19,20	0.70 mm 0.028"	5 m	0.54 kg
TG005/AE	€ 15,60	0.05 mm 0.0020"	5 m	0.05 kg	TG075/AE	€ 19,20	0.75 mm 0.030"	5 m	0.57 kg
TG006/AE	€ 15,60	0.06 mm 0.0024"	5 m	0.06 kg	TG080/AE	€ 19,20	0.80 mm 0.032"	5 m	0.59 kg
TG007/AE	€ 15,60	0.07 mm 0.0028"	5 m	0.06 kg	TG085/AE	€ 19,20	0.85 mm 0.034"	5 m	0.61 kg
TG008/AE	€ 15,60	0.08 mm 0.0030"	5 m	0.07 kg	TG090/AE	€ 19,20	0.90 mm 0.036"	5 m	0.64 kg
TG009/AE	€ 15,60	0.09 mm 0.0035"	5 m	0.07 kg	TG095/AE	€ 19,20	0.95 mm 0.038"	5 m	0.67 kg
TG010/AE	€ 15,60	0.10 mm 0.0040"	5 m	0.08 kg	TG100/AE	€ 19,20	1.00 mm 0.040"	5 m	0.69 kg
TG012/AE	€ 15,60	0.12 mm 0.005"	5 m	0.09 kg	TG110/AE	€ 14,60	1.10 mm	1 m	0.11 kg
TG015/AE	€ 14,40	0.15 mm 0.006"	5 m	0.10 kg	TG120/AE	€ 14,60	1.20 mm	1 m	0.11 kg
TG018/AE	€ 15,60	0.18 mm 0.007"	5 m	0.11 kg	TG130/AE	€ 14,60	1.30 mm	1 m	0.12 kg
TG020/AE	€ 14,40	0.20 mm 0.008"	5 m	0.13 kg	TG140/AE	€ 14,60	1.40 mm	1 m	0.13 kg
TG025/AE	€ 14,40	0.25 mm 0.010"	5 m	0.15 kg	TG150/AE	€ 14,60	1.50 mm	1 m	0.14 kg
TG030/AE	€ 14,40	0.30 mm 0.012"	5 m	0.18 kg	TG160/AE	€ 14,60	1.60 mm	1 m	0.15 kg
TG035/AE	€ 15,60	0.35 mm 0.014"	5 m	0.21 kg	TG170/AE	€ 14,60	1.70 mm	1 m	0.16 kg
TG040/AE	€ 15,60	0.40 mm 0.016"	5 m	0.26 kg	TG180/AE	€ 14,60	1.80 mm	1 m	0.17 kg
TG045/AE	€ 15,60	0.45 mm 0.018"	5 m	0.28 kg	TG190/AE	€ 14,60	1.90 mm	1 m	0.18 kg
TG050/AE	€ 15,60	0.50 mm 0.020"	5 m	0.34 kg	TG200/AE	€ 14,60	2.00 mm	1 m	0.19 kg

HT125

CAT 42 € 5,80

HOLDER FOR FEELER GAUGE BLADES



Dimensions	125 x 17 mm
Weight	0.12 kg

C026-

**PRECISION DIVIDER
WITH SQUARE LEGS**



Art.	€	Length
C026/150	€ 7,30	150 mm
C026/200	€ 9,00	200 mm
C026/250	€ 12,30	250 mm
C026/300	€ 14,20	300 mm

C028-

OUTSIDE CALIPER



Art.	€	Length
C028/150	€ 7,30	150 mm
C028/200	€ 9,00	200 mm
C028/250	€ 10,50	250 mm
C028/300	€ 12,30	300 mm

C058

€ 10,60

58 BLADE SCREW PITCH GAUGE SET



Metric size	0.25 - 6 mm 60°
Whitworth size	4 - 62 TPI 55°
Gas size	8 - 28 TPI 55°

C027-

**PRECISION DIVIDER
WITH SETTING WINGS AND SQUARE LEGS**



Art.	€	Length
C027/150	€ 10,20	150 mm
C027/200	€ 12,00	200 mm
C027/250	€ 14,90	250 mm
C027/300	€ 16,50	300 mm

C029-

INSIDE CALIPER



Art.	€	Length
C029/150	€ 7,30	150 mm
C029/200	€ 9,00	200 mm
C029/250	€ 10,50	250 mm
C029/300	€ 12,30	300 mm

P007-

MAGNETIC VEE BLOCK

SINGLE OR COUPLE

Art.	€	Dimensions	Width	Max. magnetic force	Pieces	Weight
P007/1	€ 92,70	70 x 60 x 72 mm	38 mm	400 N	1	1,6 kg
P007/2	€ 119,00	100 x 70 x 95 mm	50 / 16 mm	300 N	1	3,7 kg
P007/1C	€ 176,00	71 x 60 x 73 mm	38 mm	400 N	2	3,2 kg
P007/2C	€ 271,00	100 x 70 x 95 mm	50 / 16 mm	300 N	2	7,4 kg



P30x

90° BLOCK AND CLAMP

SINGLE AND COUPLE

 **HARDENED STEEL**

Art.	€	Dimensions	Max clamp	Accuracy	Pieces
P301/2	€ 51,90	63,5 x 63,5 x 50 mm	ø 35 mm	±0,01 mm	1
P302/2	€ 88,40	100 x 75 x 75 mm	ø 65 mm	±0,01 mm	1
P303/2	€ 136,00	150 x 125 x 100 mm	ø 110 mm	±0,01 mm	1
P301/2C	€ 100,00	63,5 x 63,5 x 50,8 mm	ø 35 mm	±0,01 mm	2
P302/2C	€ 174,00	100 x 75 x 75 mm	ø 65 mm	±0,01 mm	2
P303/2C	€ 272,00	150 x 125 x 100 mm	ø 110 mm	±0,01 mm	2



P20x

PARALLEL VEE BLOCKS

 **C45**

Art.	€	Dimensions	Accuracy
P200/1	€ 189,00	75 x 75 x 60 mm	1/100 mm
P201/1	€ 251,00	100 x 80 x 60 mm	1/100 mm

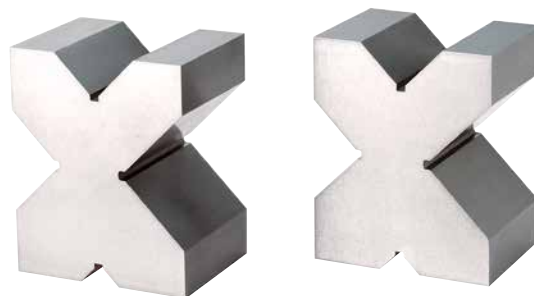

P011-

ANGLE BLOCK

Art.	€	Dimensions	Weight
P011/075	€ 87,60	75 x 32 x 25 mm	1,1 kg
P011/100	€ 104,00	102 x 48 x 46 mm	1,3 kg

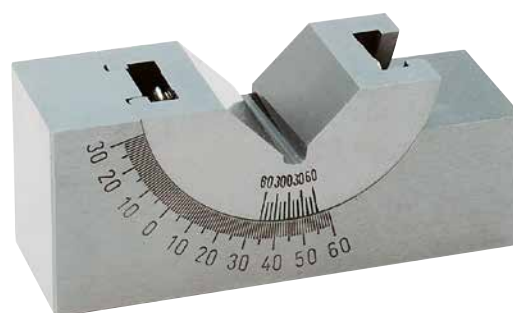

F2Gx

PRECISION TAPE

WITH STEEL WIRE STOP MECHANISM AND RIVETED END HOOK WITH BOTTOM BLADE PROTECTOR BUILT IN SHOCK ABSORBER



Art.	€	Tape dimensions	Accuracy class
F2G2	€ 2,75	2 m x 16 mm	II
F2G3	€ 3,14	3 m x 16 mm	II
F2G5	€ 4,81	5 m x 19 mm	II

F80x

PRECISION TAPE

WITH ERGONOMIC SHAPE, COMFORTABLE STOPPER, POLYESTER FILM COATING, BELT CLIP, BLADE EXTRA STRONG. RESISTANCE TO ABRASIONS, EASY TO CONTROL



Art.	€	Tape dimensions	Accuracy class
F802	€ 2,17	2 m x 16 mm	II
F803	€ 3,53	3 m x 16 mm	II
F805	€ 4,99	5 m x 19 mm	II
F808	€ 7,20	8 m x 25 mm	II

R0x

LONG TAPE

MADE OF STEEL



Art.	€	Tape dimensions
R030	€ 21,60	30 m x 13 mm
R050	€ 33,40	50 m x 13 mm

F68x

MAGNETIC PRECISION TAPE

WITH STEEL WIRE STOP MECHANISM AND RIVETED END HOOK WITH BOTTOM BLADE PROTECTOR BUILT IN SHOCK ABSORBER



Art.	€	Tape dimensions	Accuracy class
F683	€ 5,10	3 m x 19 mm	II
F685	€ 7,20	5 m x 25 mm	II
F688	€ 10,30	8 m x 25 mm	II

F32x

MAGNETIC PRECISION TAPE

WITH AUTOMATIC BRAKE AND MAGNET



Art.	€	Tape dimensions	Accuracy class
F322	€ 3,54	2 m x 16 mm	II
F323	€ 4,72	3 m x 19 mm	II
F325	€ 6,40	5 m x 25 mm	II
F328	€ 8,90	8 m x 25 mm	II

0646/A

€ 98,70

AUTOLEVELLING LASER LEVEL

Leveling accuracy	0,5 mm / m
Horizontal and vertical line accuracy	± 0,5 mm / m
Battery	3 x 1,5V AA
Laser type	Classe II / 650 nm
Recommended working distance	10 m
Max height	126,5 cm
Minimum height	52,5 cm
Weight	3 kg



0807/150

€ 23,30

MINI LASER LEVEL

POCKET MAGNETIC, WITH 1 VIAL, BODY IN ALUMINIUM



Overall sizes	150 x 19 x 38 mm
Laser type	classe II / 650 nm
Working range	30m
Power	< 1mW
Battery	2 x 1,5V AAA

0449

€ 19,60

MINI LASER LEVEL

WITH 4 VIALS, BODY IN ABS AND LASER CAPABLE OF EMITTING A SINGLE POINT OR A PERPENDICULAR CROSS



Laser type	Classe II / 650 nm
Working range	20 m
Power	< 1 mW
Accuracy	0,05°
Battery	2 x 1,5V AAA
Weight	0,3 kg

0666

€ 148,00

DIGITAL LEVEL WITH LASER

MEASURING UNIT IN DEGREES OR %



Length	600 mm
Auto power off	5 min
Measuring range	0 - 360°
Wave length	650 nm
Reading	0,1°
Laser power	<1 mW
Accuracy	± 0,05°
Pointing accuracy	±1 mm / m
Battery	2 x 1,5 V
Weight	0,5 kg

0109

€ 40,40

DIGITAL LEVEL

MAGNETIC WITH ALUMINUM BODY, AUTOMATIC POWER OFF, BACKLIGHT, 2 VIALS, INC, ABS AND HOLD FUNCIONS



Length	400 mm
Auto power off	5 min
Measuring range	0 - 90° x 4
Reading	0° - 90°: 0,1°
Accuracy	0° - 90°: ±0,2°
Battery	2 x AAA 1,5 V
Weight	0,26 kg

0112

€ 88,40

DIGITAL LEVEL

MAGNETIC WITH MILLED ALUMINUM BASE, AUTOMATIC POWER OFF, BACKLIGHT, 2 VIALS, "HOLD FUNCTION, 0° AND 90° WITH SOUND, READING: ABSOLUTE, REF, PERCENT, mm/M AND IN/FT, CARRING BAG



Length	600 mm
Auto power off	5 min
Measuring range	0 - 90° x 4
Reading	0° & 90°: 0,05°, 0° - 89°: 0,1°
Accuracy	0° & 90°: ±0,05°, 0,1° - 89,9°: ±0,2°
Battery	2 x AAA 1,5 V
Weight	0,6 kg

L090A

€ 91,80

DIGITAL LEVEL - INCLINOMETER AND GONIOMETER WITH MAGNET

0 ÷ 90° MAGNETIC DIGITAL LEVEL ON ALL THE 4 DIRECTIONS, INCLINOMETER AND GONIOMETER, FUNCTION: INCLINATION mm/M AND IN/FT, % OF INCLINATION, BACKLIGHT, AUTOMATIC POWER OFF, ABS AND RELATIVE MEASUREMENTS AND AUTOMATIC DIGIT INVERSION FOR OVERHEAD MEASUREMENTS, WITH BEEPER



Plastic box

Accuracy	± 0,15°
Measuring range	0 ÷ 90° x 4
Reading	0,05°
Dimensions	151 x 31 x 60 mm
Battery	2 x 1,5 V AAA
Weight	285 g

L080

€ 44,60

DIGITAL LEVEL BOX

0 ÷ 90° MAGNETIC ON ALL THE 4 DIRECTIONS, BACKLIGHT, AUTOMATIC POWER OFF, ABS AND RELATIVE MEASUREMENTS AND AUTOMATIC DIGIT INVERSION FOR OVERHEAD MEASUREMENTS



Blister

Accuracy	0° ± 0.1°; 90° ± 0.1°; 0.1° ÷ 89.9° ± 0.2°
Measuring range	0 ÷ 90° x 4
Reading	0.1°
Dimensions	59 x 27 x 59 mm
Battery	1 x 1.5 V AAA
Weight	82 g

0805/400

€ 7,70

MAGNETIC LEVEL

HEAVY DUTY WITH 3 VIALS



Overall sizes 400 x 50 x 20 mm

L200

€ 158,00

LINEAR LEVEL

MASTER PRECISION, WITH V-SLOT S GROUND



Overall sizes 200 x 45 x 45 mm
Accuracy 0,02 mm / m

L085

€ 70,40

DIGITAL LEVEL BOX

± 0 ÷ 180° MAGNETIC, AUTOMATIC POWER OFF, ABS AND RELATIVE MEASUREMENTS AND AUTOMATIC DIGIT INVERSION FOR OVERHEAD MEASUREMENTS, HOLD FUNCTION



Blister

Accuracy	± 0.1°
Measuring range	0° ÷ 180°
Reading	0.1°
Dimensions	51 x 51 x 33 mm
Battery	1 x 3 V CR2032
Weight	150 g

0824-

LEVEL

HEAVY DUTY ALUMINIUM MILED LEVEL WITH 3 VIALS



Art.	€	Dimensions
0824/300	€ 4,72	300 x 49 x 23 mm
0824/400	€ 5,30	400 x 49 x 23 mm
0824/500	€ 6,20	500 x 49 x 23 mm
0824/600	€ 7,10	600 x 49 x 23 mm

L150

€ 184,00

SQUARE LEVEL

MASTER PRECISION, WITH 2 PLANE SIDES AND 2 PRISMATIC SIDES



Overall sizes 150 x 38 x 150 mm
Accuracy 0,02 mm / m



G008

€ 42,90

DIGITAL ANGLE FINDER AND LEVEL WITH 2 VIALS

AUTOMATIC CALCULATION OF ANGLES AND INCLINATIONS



Length	400 mm
Range	0 ÷ 225°
Reading	0,1°
Accuracy	± 0,5°
Battery	9 V - 6F22

G006-

PROTRACTOR



Art.	€	Arch	Beam
G006/120	€ 23,40	120 mm	150 mm
G006/150	€ 31,70	150 mm	200 mm
G006/200	€ 39,60	200 mm	300 mm

G005

€ 71,80

UNIVERSAL BEVEL PROTRACTOR



Plastic case

Reading	5'
Range	0° ÷ 360°
Beam	300 mm



E023/5

€ 558,00

FLEXIBLE ENDOSCOPE FOR MECHANICAL USE

WITH PROBE Ø 5.5 mm - WI-FI USB EQUIPPED WITH: 3.5 " COLOR LCD SCREEN WITH WI-FI CONNECTION TO THE PROBE - MEMORY MICRO SD 2GB WITH SD ADAPTER - USB PORT - OUTPUT WITH USB CABLE - FLEXIBLE PROBE - CAMERA WITH LED LIGHTS - 45 ° MIRROR - BALL DIRECTION - PROTECTION RING NUT



Blow mold case

Length without handle	1000 mm
Probe	Ø 5,5 mm
Digital zoom	4 X
Depth of field	50 mm
View	60°
Rechargeable battery	Lithium

E022/12

€ 288,00

FLEXIBLE ENDOSCOPE FOR MECHANICAL USE

WITH PROBE Ø 12 mm EQUIPPED WITH: 3.5 " COLOR LCD SCREEN , FLEXIBLE PROBE, CAMERA WITH LED LIGHTS, YOU CAN ADD UP TO 2 EXTENSIONS, MAGNETIC TERMINAL , TERMINAL HOOK, TERMINAL WITH MIRROR



Blow mold case

Length without handle	900 mm
Probe	Ø 12 mm
View	0° - 60°
Battery	9 V

E022/5

€ 288,00

FLEXIBLE PROBE



Dimensions	Ø 5,5 mm
Length	1070 mm

E022/P

€ 62,70

FLEXIBLE EXTENSION



Dimensions	Ø 18 mm
Length	2750 mm

M069

€ 460,00

STEREO MICROSCOPE



Color box

Independent transmitted illumination	12 V - 10 W
Working range	165 mm 10x - 119 mm 20x
Power	230 V 50 Hz
Eyepieces	10x - 20x
Objectives	1x - 2x
Magnification	10x ÷ 40x
Weight	2,8 kg

M071

€ 325,00

STEREO MICROSCOPE



Color box

Independent incident and transmitted illumination	12 V - 10 W
Max height of piece to check	75 mm
Power	230 V 50 Hz
Eyepieces	10x
Objectives	2x - 4x
Magnification	20x ÷ 40x
Weight	2,8 kg



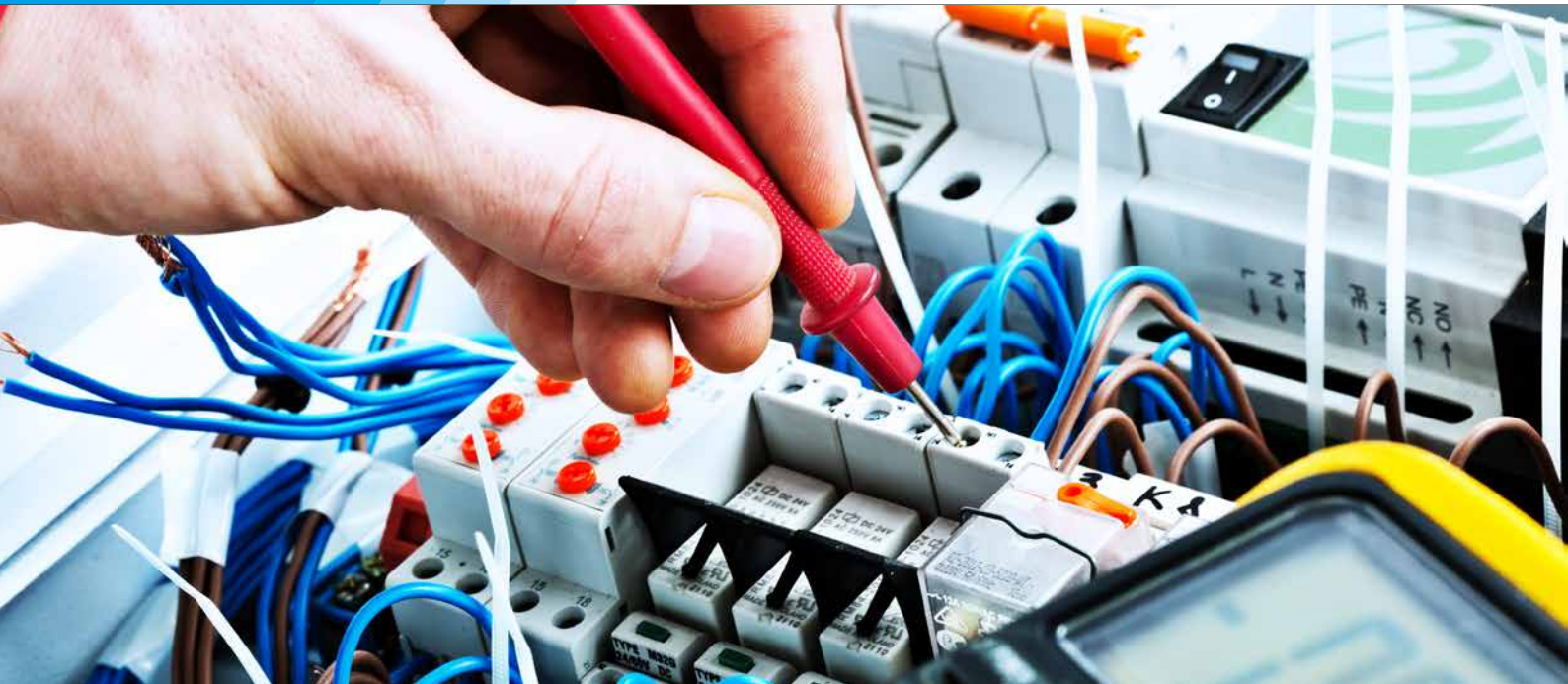

M072

€ 23,70

MAGNIFIER FOR MEASURING



Color box

Magnification	10x
Field of view	24 mm
Range	0-20 mm
Reading	0,1 mm

P075

€ 109,00

DIGITAL CLAMP METER

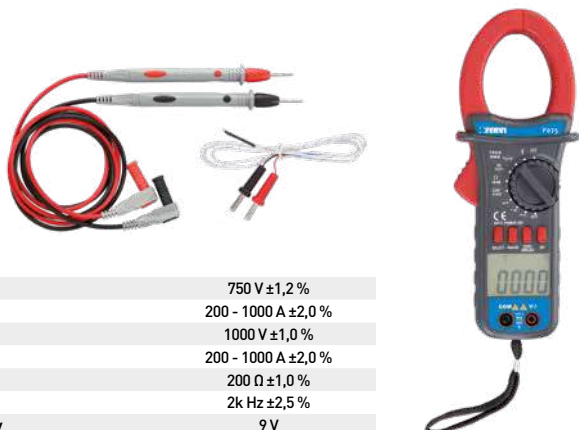

ACV	750 V ±1,2%
ACA	200 - 1000 A ±2,0%
DCV	1000 V ±1,0%
DCA	200 - 1000 A ±2,0%
RES	200 Ω ±1,0%
FREQ	2k Hz ±2,5%
Battery	9 V

P080

€ 65,10

DIGITAL CLAMP METER



ACV	4 / 40 / 400 / 600 V ±1,5% + 4
ACA	4 / 40 / 400 / 600 A ±1,5% + 4
DCV	4 / 40 / 400 / 600 V ±1,0% + 2
RES	400 Ω / 4 kΩ / 40 kΩ / 400 kΩ / 4 MΩ / 40 MΩ ±1,0% + 2
FREQ	10 MHz ±0,8% + 2
Battery	2 x 1,5 V x AA

T051

€ 15,50

POCKET DIGITAL MULTIMETER
AUDIBLE CONTINUITY AND DIODE TEST



DCV	2-20-200-500V ±0,5%
ACV	200-500V ±1,2%
DCA	200mA ±1,5%
RES	2K-20K-200K-2M Ω ±1%
Battery	12V

T050

€ 30,80

DIGITAL MULTIMETER

HIGH ACCURACY TEMPERATURE METER, AUDIBLE CONTINUITY AND DIODE TEST

DCV	200 mV ±0,5%
DCV	2 V - 20 V - 200 V ±0,8%
DCV	1000 V ±0,1%
ACV	2mV - 20 V - 200 V ±1,0%
ACV	750 V ±1,2%
DCA	2 mA - 20 mA ±1,8%
DCA	200 mA ±2,0%
DCA	20 A ±2,0%
ACA	200 mA ±2,0%
ACA	20 A ±3,0%
RES	200 Ω ±1,0%
RES	2KΩ - 20KΩ - 200KΩ - 2MΩ ±1,0%
RES	20 MΩ ± 1.0%
RES	200 MΩ ±5.0%
CAP	2000 pF - 20 nF - 200 nF - 2 μF - 20 μF ±4%
Temperature	-40 °C ÷ 400 °C ±1,0%
Temperature	400 °C ÷ 1000 °C ±1,5%
Battery	9 V



T053

€ 74,00

DIGITAL MULTIMETER

HIGH ACCURACY TEMPERATURE METER, AUDIBLE CONTINUITY AND DIODE TEST

DCV	200 mV - 2 V - 20 V - 200 V - 1000 V ±0,8%
ACV	200 mV - 2 V - 20 V - 750 V ±1,2%
DCA / ACA	200 μA - 2 mA - 20 mA - 200 mA - 20 A ±2,0%
RES	200Ω - 2kΩ - 20kΩ - 200kΩ - 2MΩ - 20MΩ - 200MΩ ±1%
CAP	20 nF / 200 nF / 2 μF / 20 μF / 200 μF / 2000 μF ±2,5%
Inductance	2 mH - 20mH - 200 mH - 2 H - 20 H
Battery	9 V
Temperature	-20 °C ÷ 1000 °C
Frequency	10 mHz
Audible continuity and diode test	
hFE transistor test	0 ~ 1000
Weight	400 g



0446

€ 11,60

BATTERY AND CHARGING SYSTEM TESTER

WITH LED LIGHTS THAT INDICATE THE STATUS OF THE BATTERY AND OF THE CHARGING SYSTEM. EASY TO USE



Blister

Battery	11,5 ÷ 12,6V
Charging system voltage range	13,2 ÷ 15,5 V
Cable length	800 mm
Weight	0,1 kg

0013/142

€ 1,36

CIRCUIT TESTER SCREWDRIVER

WITH HANDLE IN INSULATING MATERIAL, NEON LIGHT AND STEEL BLADE



Range	100 ÷ 500 V
Length	142 mm

0013/185

€ 1,48

CIRCUIT TESTER SCREWDRIVER

WITH HANDLE IN INSULATING MATERIAL, NEON LIGHT AND STEEL BLADE



Range	100 ÷ 500 V
Length	190 mm



0029

€ 4,51

AUTOMOTIVE CIRCUIT TESTER

FOR THE IDENTIFICATION OF THE CURRENT IN THE WIRES OF THE CARS, WITH VOLTAGE OF 6-12-24 V



Weight	40 g
Voltage	6 - 12 - 24 V

ML40

€ 49,80

LASER DISTANCE METER

IDEAL FOR THE MEASUREMENTS IN CONSTRUCTION AND CARPENTRY, FUNCTIONS: ADDITION, SUBTRACTION, AREA AND VOLUME CALCULATION, AUTO POWER OFF



54

Range	0,05 ÷ 40 m
Accuracy	± 2 mm
Battery	2 AAA x 1.5 V
Weight	0.07 kg

T068

€ 108,00

LASER POINTER INFRARED TEMPERATURE METER



Blister

Range	-30°C ÷ 550 °C / -22 °F ÷ 1022 °F
Accuracy	-30 °C ÷ 0 °C [-22 °F ÷ 32 °F] ±3% ±0.3 °C
Accuracy	0 °C ÷ 100 °C [32 °F ÷ 212 °F] ±2% ±0.2 °C
Accuracy	> 100 °C (> 212 °F) ±3% ±0.3 °C
Reading	0,1 °C / 0.1 °F
Emissivity	0,1 ÷ 1,0
Battery	9 V
Weight	130 g
Overall sizes	146 x 80 x 38 mm
Distance/Spot size	1 : 12

ML80A

€ 67,00

LASER METER

HANDY AND LIGHTWEIGHT, IDEAL FOR THE MEASUREMENTS IN CONSTRUCTION AND CARPENTRY, FUNCTIONS: ADDITION, SUBTRACTION, AREA AND VOLUME CALCULATION, AUTO POWER OFF



54

Range	0,05 ÷ 80 m
Accuracy	±2 mm
Battery	3 AAA x 1,5 V
Weight	130 g

M035

€ 45,70

LASER POINTER ULTRASONIC DISTANCE METER

FUNCTIONS: ADDITION, SUBTRACTION, AREA AND VOLUME CALCULATION, AUTO POWER OFF



Color box

Range	0,9 ÷ 18,30 m / 3 ÷ 60 piedi - Ft
Reading	0,01 m / 0,5 pollici - inch
Accuracy	0,5% ±1 cifra / ±1 digit
Conversion button	m/piedi - m/feet
Memory	3
Battery	9 V
Overall sizes	155 x 72 x 43 mm

T064

€ 83,10

LASER POINTER INFRARED TEMPERATURE METER



Blister

Range	-25°C ÷ 400 °C / -13 °F ÷ 752 °F
Accuracy	-25 °C ÷ 400 °C ±(2% + 1 °C)
Accuracy	-13 °F ÷ 752 °F ±(2% +1 °F)
Reading	1 °C / 2 °F
Battery	9 V
Weight	300 g
Distance/Spot size	1 : 10

T054

€ 30,80

POCKET DIGITAL TEMPERATURE METER

WITH ENVIRONMENTAL AND IMMERSION PURPOSE THERMOCOUPLES



Color box

Reading	1° C
Range	-50°C ÷ 1100°C with not supplied probe T056/TP03, -50°C ÷ 750°C with supplied probe T056/TP02, -50°C ÷ 250°C with supplied probe T056/TP01
Accuracy	0°C ÷ 500°C ±(0,75%+1°C), 500°C ÷ 750°C ± (1% + 1°C), 750°C ÷ 1000°C ± (2% + 1°C), 1000°C ÷ 1200°C ± (4% + 3°C)
Thermocouple type	"K"
Battery	9 V

T063

€ 55,70

PORTABLE DIGITAL TEMPERATURE METER

ENVIRONMENTAL AND IMMERSION PURPOSE THERMOCOUPLES TYPE "K", DOUBLE TEMPERATURE DETECTION, WITH BOX



Range	T056/TP01: -50°C ÷ 250°C
Range	T056/TP02: -50°C ÷ 750°C
Reading	1° C
Accuracy	-50 °C ÷ 1200 °C ±(0.3 % + 2 °C)
Accuracy	1200°C ÷ 1300 °C ±(0.6 % + 2 °C)
Accuracy	-58 °F ~ 1200°F ±(0.3 % + 2 °F)
Accuracy	1200 °F ~ 1999 °F ±(0.6 % + 2 °F)
Battery	9 V



T055

€ 120,00

PORTABLE DIGITAL TEMPERATURE METER

ENVIRONMENTAL AND IMMERSION PURPOSE THERMOCOUPLES TYPE "K" WITH PLASTIC BOX



Range	T056/TP01: -50°C ÷ 250°C
Range	T056/TP02: -50°C ÷ 750°C
Reading	0,1 °C (<1000 °C)
Reading	0,1 °F (<1000 °F) mm
Accuracy	±(0,3% n+1.8 °F)
Accuracy	±(0,3% n+1 °C)
Overall sizes	178 x 68 x 39 mm
Weight	190 g
Thermocouple length	120 mm
Battery	4 x 1,5 V AA

T056/TP01

€ 7,30

ENVIRONMENTAL THERMOCOUPLE "K" TYPE



Range	-50°C ÷ 250°C
Thermocouple type	"K"
Thermocouple length	2 mm

T056/TP02

€ 8,90

ENVIRONMENTAL OR IMMERSION THERMOCOUPLE "K" TYPE



Range	-50°C ÷ 750°C
Thermocouple type	"K"
Total length	240 mm

T056/TP03

€ 53,20

THERMOCOUPLE "K" TYPE

ENVIRONMENTAL OR IMMERSION



Range	-50 °C ÷ 1100 °C
Thermocouple type	"K"
Thermocouple length	650 mm

T057

€ 185,00

ENVIRONMENTAL TEMPERATURE AND HUMIDITY DIGITAL TESTER



Plastic box

Temperature	-10 °C ÷ +65 °C
Temperature reading	0,1° C
Temperature accuracy	±0,5 °C
Humidity	10 % ÷ 100 %
Accuracy	2 % ±1 % RH
Weight	650 g
Battery	4 x 1,5 V AA

I002

€ 270,00

**INDUCTIVE MOISTURE METER FOR MEASURING HUMIDITY
METER FOR HUMIDITY IN WOOD MOISTURE CONTENT AND OTHER MATERIALS**



Working temperature	0 °C - 40 °C
Range	0 - 80 %
Building moisture	0 - 50 %
Reading	0,1 %
Accuracy	± (0,5 % n+1)
Battery	4 x 1,5 V AA

F010

€ 255,00

SOUND LEVEL METER



IEC651 CLASS II Plastic box

Frequency range	31,5 Hz ÷ 8 kHz
Range	30 dB ÷ 130 dB (A) / 32 dB ÷ 130 dB (C) / 35 dB ÷ 130 dB (Lineare)
Reading	0,1 dB
Functions	SL, LN, Leq (livello equivalente)
Detection characteristics	Fast, Slow, Max
Sampling time	0,1 s
Display	10 mm
Working temperature	-10 °C ÷ 40 °C
Weight	300 g
Not included batteries	4 x 1,5 V AAA

L014

€ 59,50

DIGITAL LUXMETER



Range	0 LUX ÷ 2000 LUX ÷ 20000 LUX ÷ 50000 LUX
Reading	1 LUX
Accuracy	± 5 %
Battery	9 V

A005

€ 170,00

DIGITAL ANEMOMETER

Plastic box

AIR SPEED MEASUREMENT	
Measurement	m/s - Km/h - ft/min - Knots
Spindle speed	0,4 ÷ 30,0 / 1,4 ÷ 108 / 80 ÷ 5910 / 0,8 ÷ 58,3
Reading	0,1
Accuracy	± [2 % + 1 cifra] / ± [2 % + 3 cifra] / ± [2 % + 2 cifra] / ± [2 % + 2 cifra]
TEMPERATURE MEASUREMENT	
Range	0° C ÷ 60° C / 32° F ÷ 140° F
Reading	0,1° C / 0.1° F
Accuracy	0,5° C / 0.9° F
Weight	325 g
Battery	9 V not included



0387

€ 56,60

DIGITAL MULTI-FUNCTION SENSOR



 Color box

Max depth of detecting	
Ferrous metal	60 mm
No ferrous metal	50 mm
Wood	20 mm
Depth of AC	40 mm
Battery	9 V
Weight	250 g

C069

€ 91,00

CONTACT TYPE DIGITAL TACHOMETER



 Plastic box

Round speed	2,5 - 9999,9 rpm
Surface speed	0,05 - 999,99 m/min
Reading	0,1 (7,5 - 999,9) rpm
Reading	1 (1000-9999,9) rpm
Accuracy	± 0,05 % + 1 cifra
Overall sizes	190 x 72 x 37 mm
Weight	300 g
Battery	4 x 1,5 V AA

C070

€ 127,00

CONTACT AND OPTICAL TYPE DIGITAL TACHOMETER

WITH REFLECTIVE STRIPES



 Plastic box

Rotation Laser speed	2,5 ÷ 9999,9 rpm
Rotation contact speed	0,05 ÷ 999,9 rpm
Surface speed	0,1 ÷ 999,99 m / min
Reading	0,1 (2,5 ÷ 999,9) rpm
Reading	1 (1000 ÷ 9999,9) rpm
Use distance	da 50 ÷ 60 mm a 50 ÷ 250 mm (con ottico)
Accuracy	± 0,05 % + 1 cifra
Overall sizes	220 x 75 x 29 mm
Battery	4 x 1,5V AA

MD01

€ 97,40

METAL DETECTOR

ANALOG METAL DETECTOR COMPOSED OF VIEW METER, 2 COLOUR LED WHICH SHOW THE TYPE OF METAL BEING DETECTED, AUDIO SENSOR, ADJUSTABLE VOLUME, AUTO TUNE, SIMPLE DISC, WATERPROOF SEARCHING COIL, COMFORTABLE ARM SUPPORT AND LOW BATTERY INDICATOR



Coil diameter	170 mm
Jack connector	1/4"
Sensitivity	> 15 cm per una moneta di ø 25 mm
Battery	9 V
Weight	1,7 kg

C067

€ 91,00

PHOTO TYPE DIGITAL TACHOMETER

WITH REFLECTIVE STRIPES



 Plastic box

Range	2,5 ÷ 9999,9 rpm
Reading	0,1 (2,5 ÷ 999,9) rpm
Reading	1 (1000 ÷ 9999,9) rpm
Use distance	da 50 ÷ 60 mm a 50 ÷ 250 mm
Accuracy	± 0,05 % della lettura + 1 cifra / ± 0,05 % of reading + 1 dgt
Overall sizes	170 x 72 x 37 mm
Battery	4 x 1,5V AA

V002

€ 893,00

VIBRATION TESTER

EQUIPPED OF MAGNETIC PROBE, 2 ENDS, SOFTWARE AND USB CABLE



Acceleration	0,1 ÷ 400 m/s ²
Speeds	0,01 ÷ 40 cm/s
Displacement	0,001 ÷ 4 mm
Balancing rpm	60 ÷ 99,990
Frequency	1÷20 kHz
Accuracy	± 5 %
Battery	4 x 1,5V AA

S004

€ 1230,00

ULTRASONIC THICKNESS GAUGE



Blow mold case

Reading	4-digit LCD
Range	1,0 - 225,0 mm
Accuracy	±0,1 mm
Overall sizes	126 x 68 x 23 mm
Weight	170 g
Battery	2 x 1,5 V AA

0583

€ 74,00

BRIX REFRACTOMETER



Plastic box

Range	0 ÷ 80 % Brix
Reading	1 % Brix

0312

€ 74,00

REFRACTOMETER TO MEASURE FREEZING POINT



Plastic box

Range for coolants E	-50 °C ÷ 0 °C
Reading	1 °C
Range for coolants P	-50 °C ÷ 0 °C
Reading	1 °C
Range for battery liquids B	1,10 ÷ 1,40 sg
Reading	0,01 sg
Range for cleaner liquids C	-40 ÷ 0 °C
Reading	5 °C

R008

€ 773,00

DIGITAL COATING THICKNESS GAUGE FOR FERROUS AND NON-FERROUS BASES

SOFTWARE EQUIPPED



Blow mold case

Range	0 ÷ 1250 µm
Reading	0,1 µm
Accuracy	±3 µm o/or 2,5 µm
Battery	3 x 1,5 V AAA

0433

€ 67,90

REFRACTOMETER

BRIX, USEFUL TO CHECK COOLANT OILS



Plastic box

Range	0 ÷ 32% Brix
Reading	0,2% Brix

D007/A

€ 64,90

SHORE "A" DUROMETER

RUBBER AND SOFT MATERIAL HARDNESS TESTER



Range	0 ÷ 100 A
Reading	2 A
Weight	128 g

D011/A

€ 113,00

SHORE "A" DIGITAL DUROMETER

RUBBER AND SOFT MATERIAL HARDNESS TESTER



Range 0 + 100 A
Reading 0.5 A

D011/D

€ 113,00

SHORE "D" DIGITAL DUROMETER

HARD RUBBER AND PLASTIC MATERIAL HARDNESS TESTER



Range 0 + 100 D
Reading 0.5 D

P013

€ 118,00

SHORE "A" DUROMETER TEST BLOCK

WITH VARIABLE HARDNESS FROM 26HA TO 88HA. TEST BLOCK COLOURS: PURPLE, BROWN, GREEN, ORANGE, RED, YELLOW AND GREY. PRECISION ±2HA



7 Pcs

D001

€ 2010,00

HARDNESS TESTING MACHINE

MOTORIZED, ROCKWELL, BRINELL AND VICKERS



Wooden case

Test force	294,2 N / 306,5 N / 588,4 N / 612,9 N / 980,7 N / 1471 N / 1839 N; 30 kgf / 31,25 kgf / 60 kgf / 62,5 kgf / 100 kgf / 150 kgf / 187,5 kgf
Diamond cone and pyramid penetrators	n° 1+1
Steel ball penetrators	n° 3
Flat anvils	n° 2
V - anvil	n° 1
Hardness test blocks	n° 1 Brinell; n° 5 Rockwell; n° 1 Vickers
Magnification	37,5x - 75x
Max Height of tested piece	Rockwell: 175 mm; Brinell - Vickers: 145 mm
Throat depth	160 mm
Power	230 V - 50 / 60 Hz - 6 W
Durometer dimensions	525 x 240 x 730h mm
MEASURE UNITS:	
HBS	4 - 450
HRB	20 - 100
HRA	20 - 88
HRC	20 - 70
HV	200 - 1000
Weight	70 kg



D018

€ 3850,00

ROCKWELL HARDNESS TESTING MACHINE

 **Wooden case**

Reading	0,5 HR
Diamond and still ball penetrators	n° 1+1
Flat anvils	n° 2
V - anvil	n° 1
Hardness test blocks	n° 5 (HRC, 3xHRB, HRA)
Max Height of tested piece	170 mm
Throat depth	125 mm
Durometer dimensions	185 x 465 x 640 mm
Test force	588,4 N / 980,7 / 1471 N (60 kgf / 100 kgf / 150 kgf)

MEASURE UNITS:

HRC	20 ÷ 70
HRB	25 ÷ 100
HRA	20 ÷ 88
Weight	90 kg



S110

€ 325,00

CONCRETE TEST HAMMER

FOR MEASURING THE HARDNESS OF CEMENT MANUFACTURED PRODUCTS



Test force	2.207 Nm
Spring tension	7.84 N
Swing	75 mm
Weight	1,5 kg

R002

€ 2330,00

DIGITAL ROUGHNESS TESTER

WITH PIEZOELECTRIC PROBE

 **Blow mold case**

Ra	0,03 ÷ 6,30 µm
R max	0,20 ÷ 25,00
Rz	0,20 ÷ 25,00
Cut off	0,8 mm
Evaluation length	0,8 mm / 2,4 mm / 4,0 mm
Reading	0,01 µm
Overall sizes	150 x 33 x 83 mm
Weight	490 g
Battery	9 V

S111

€ 359,00

ANVIL FOR CONCRETE TEST HAMMER SETTING



Weight 16 kg



B031

€ 19,60

HIGH ACCURACY DIGITAL POCKET SCALE

NOT LEGAL FOR TRADE



Color box

Capacity	100 g
Reading	0,01 g
Weighing mode	g / dwt / tl / ct
Weight	100 g

B003/5/1

€ 28,60

ELECTRONIC DIGITAL SCALE

NOT LEGAL FOR TRADE, AUTO POWER OFF, TARE FUNCTION



Color box

Capacity	5 kg - 176,4 oz
Reading	1 g - 0.1 oz
Battery	2 x 1,5V AA
Overall sizes	170 x 240 x 35 mm
Weight	0,5 kg

B021

€ 16,00

HIGH ACCURACY DIGITAL POCKET SCALE

NOT LEGAL FOR TRADE



Color box

Capacity	500 g
Reading	0,1 g
Weighing mode	g / dwt / gn / ct
Weight	100 g

B018

€ 104,00

ELECTRONIC DIGITAL SCALE WITH DOUBLE DISPLAY

NOT LEGAL FOR TRADE WITH 4V 4AH BATTERY AND TRANSFORMER



Color box

Capacity	30 kg
Reading	10 g
Platform size	340 x 230 mm
Overall sizes	350 x 330 x 120 mm
Power	230V 50 Hz
Rechargeable battery	4 V 4 Ah
Weight	3,5 kg



B004-

RECHARGEABLE ELECTRONIC DIGITAL COUNTER SCALES

NOT LEGAL FOR TRADE WITH 6V 4 AH BATTERY AND TRANSFORMER



0561/B

€ 29,80

SPARE PART BATTERY

Art.	€	Capacity	Reading	Weight	Scale dimensions	Platform dimensions	Rechargeable battery
B004/7	€ 318,00	7,5 kg	0,2 g	5 kg	350 x 340 x 105 mm	335 x 228 mm	6 V 4 Ah
B004/30	€ 318,00	30 kg	1 g	5 kg	350 x 340 x 105 mm	335 x 228 mm	6 V 4 Ah

B004/150

€ 620,00

RECHARGEABLE ELECTRONIC DIGITAL COUNTER SCALE

NOT LEGAL FOR TRADE WITH 6V 4AH BATTERY AND TRANSFORMER

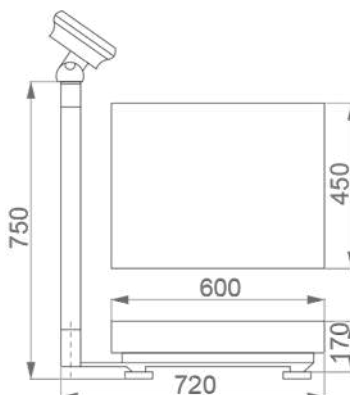

0561/B

€ 29,80

SPARE PART BATTERY

Capacity	150 kg
Reading	10 g
Weight	17 kg
Rechargeable battery	6 V 4 Ah

D012-

DIGITAL DYNAMOMETERS

NOT LEGAL FOR TRADE WITH 6V 10AH BATTERY AND TRANSFORMER



Art.	€	Digits sizes	Capacity	Reading	Minimum weighing	Max weight	Weight	Rechargeable battery
D012/0100	€ 727,00	40 x 20 mm	1000 kg	0,200 kg	0,200 kg	150%	14 kg	6 V 10 Ah
D012/0300	€ 862,00	40 x 20 mm	3000 kg	0,500 kg	0,500 kg	150%	14,5 kg	6 V 10 Ah
D012/0500	€ 998,00	40 x 20 mm	5000 kg	1 kg	1 kg	150%	21 kg	6 V 10 Ah
D012/1000	€ 1180,00	40 x 20 mm	10000 kg	2 kg	2 kg	150%	34 kg	6 V 10 Ah







BLACK EDITION

pag.307 — Wrenches

pag.308 — Hex keys

pag.309 — Screwdrivers

pag.311 — Pliers



WRENCHES

pag.314 — Ratchets wrenches

pag.315 — Double open end wrenches

pag.315 — Combination spanners

pag.318 — Ring spanners

pag.322 — Tubular sockets

pag.323 — Hex keys

pag.326 — Tork keys

pag.327 — Sockets

pag.329 — Filter wrenches

pag.330 — Torque wrenches



SOCKET WRENCHES AND SCREW EXTRACTORS

pag.334 — Quick-release ratchets

pag.336 — Sockets

pag.349 — impact sockets

pag.357 — Screw extractors



SCREWDRIVERS AND HAND RIVETERS

pag.358 — Sockets screwdrivers

pag.360 — Screwdrivers

pag.364 — Precision screwdrivers

pag.366 — Hex bits

pag.371 — Hand riveters



PLIERS, HAMMERS, FILES AND CHISELS

pag.373 — Pliers

pag.377 — Grip pliers

pag.378 — Pipe wrenches

pag.379 — Hammers

pag.382 — Chisels

pag.385 — Files

pag.387 — Levers



UTILITY KNIVES, DEBURRING AND CUTTING TOOLS

pag.388 — Utility knives

pag.390 — Snaggers

pag.392 — Jigsaws arches

pag.394 — Scissors

pag.395 — Tube and bolt cutters



SETS AND FASTENINGS

PAG.398 — Staplers and brad nailers

PAG.399 — Sets



WORKSHOP FURNITURE

pag.404 — Workshop furniture

pag.415 — Workbenches

pag.417 — Cabinets

pag.420 — Cases



TOOL CABINETS AND TOOL SETS

pag.421 — Tool rolling cabinets

pag.430 — Series of thermoformed tools

pag.437 — Tool boxes with tools

pag.441 — Tool boxes



**BLACK EDITION:
NO COMPROMISE**

**Discover made in Europe tools
with the best price/quality ratio**

The quest for the best materials for every function, the ergonomics research into the perfect handle, innovative design focused on operator safety: discover Fervi's Black Edition, more than 100 new top-of-the-range items, all exclusively made in Europe and selected individually for you, to give you always and only the best value for money, thanks to our meticulous choice, with no compromises.

MADE IN EUROPE QUALITY

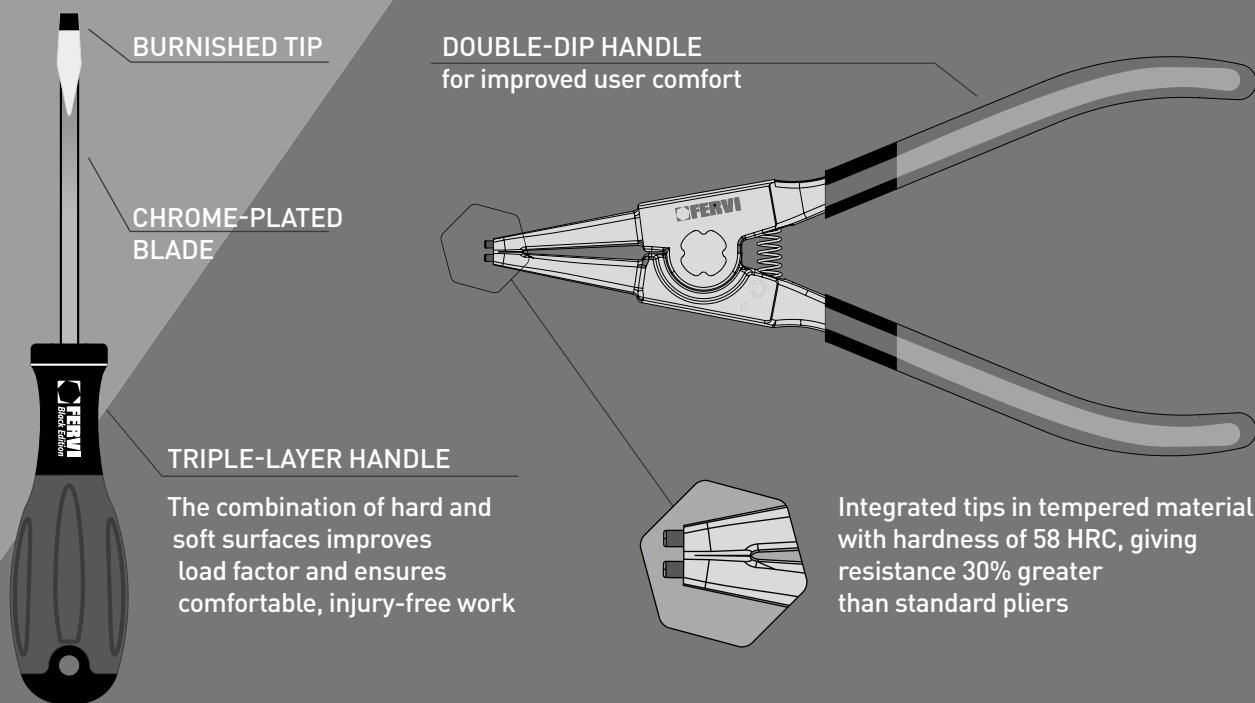

BURNISHED TIP

CHROME-PLATED
BLADE

TRIPLE-LAYER HANDLE

The combination of hard and soft surfaces improves load factor and ensures comfortable, injury-free work

DOUBLE-DIP HANDLE
for improved user comfort

Integrated tips in tempered material with hardness of 58 HRC, giving resistance 30% greater than standard pliers

BE10-

OPEN END WRENCHES

DROP FORGED, ENTIRELY HARDENED AND TEMPERED WITH POLISHED HEAD

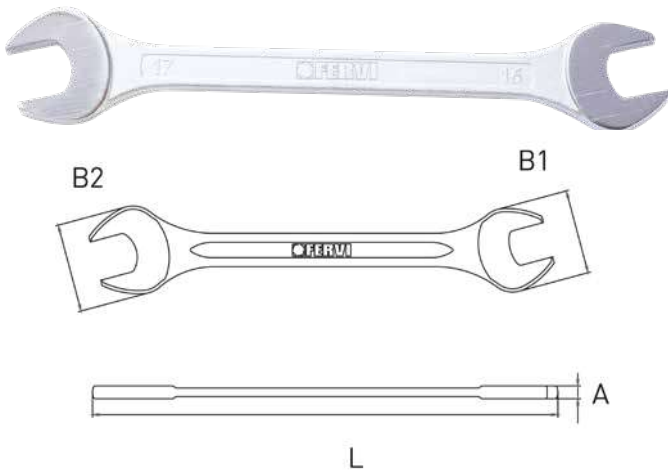

Cr-V Chromed ISO 10102 Hanger

Art.	€	Size	L	A	B1	B2
BE10/0607	€ 2,47	6x7 mm	121 mm	4,5 mm	20 mm	22 mm
BE10/0809	€ 2,87	8x9 mm	140 mm	5 mm	24 mm	26 mm
BE10/1011	€ 3,33	10x11 mm	159 mm	6 mm	28 mm	30 mm
BE10/1213	€ 3,68	12x13 mm	172 mm	7 mm	32 mm	34 mm
BE10/1415	€ 4,25	14x15 mm	192 mm	7,5 mm	36 mm	39 mm
BE10/1617	€ 5,10	16x17 mm	206 mm	8,5 mm	41 mm	43 mm
BE10/1819	€ 5,80	18x19 mm	222 mm	9 mm	45 mm	47 mm
BE10/2022	€ 7,00	20x22 mm	232 mm	10 mm	51 mm	53 mm
BE10/2123	€ 7,90	21x23 mm	249 mm	10,5 mm	51 mm	57 mm
BE10/2426	€ 9,10	24x26 mm	265 mm	11,5 mm	57 mm	64 mm
BE10/2528	€ 10,10	25x28 mm	279 mm	12 mm	64 mm	70 mm
BE10/3032	€ 12,00	30x32 mm	309 mm	13,5 mm	70 mm	74 mm

BE11-

COMBINATION WRENCHES

DROP FORGED, ENTIRELY HARDENED AND TEMPERED WITH POLISHED HEAD, RING PART WITH PROFILE SUITABLE FOR DAMAGED NUTS AND HEADS

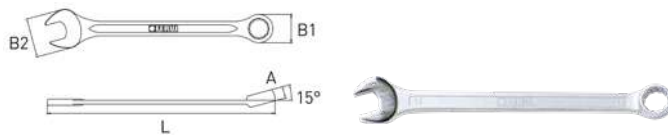

Cr-V Chromed ISO 7738 Hanger

Art.	€	Size	L	A	B1	B2
BE11/06	€ 2,93	6 mm	119 mm	6,5 mm	11 mm	20 mm
BE11/07	€ 3,00	7 mm	129 mm	7 mm	12,5 mm	22 mm
BE11/08	€ 3,33	8 mm	141 mm	8 mm	14 mm	24 mm
BE11/09	€ 3,68	9 mm	152 mm	8,5 mm	15,5 mm	26 mm
BE11/10	€ 3,72	10 mm	163 mm	9 mm	17 mm	28 mm
BE11/11	€ 4,00	11 mm	177 mm	9,5 mm	18,5 mm	30 mm
BE11/12	€ 3,82	12 mm	187 mm	10 mm	20 mm	32 mm
BE11/13	€ 4,13	13 mm	200 mm	11 mm	21,5 mm	34 mm
BE11/14	€ 4,33	14 mm	210 mm	11,5 mm	23 mm	36 mm
BE11/15	€ 4,58	15 mm	222 mm	12 mm	24,5 mm	39 mm
BE11/16	€ 5,00	16 mm	233 mm	12,5 mm	26 mm	41 mm
BE11/17	€ 5,60	17 mm	245 mm	13 mm	27,5 mm	43 mm
BE11/18	€ 6,30	18 mm	257 mm	14 mm	29 mm	45 mm
BE11/19	€ 7,30	19 mm	268 mm	14,5 mm	30,5 mm	47 mm
BE11/20	€ 8,60	20 mm	280 mm	15 mm	32,5 mm	50 mm
BE11/21	€ 8,60	21 mm	291 mm	15,5 mm	33,5 mm	51 mm
BE11/22	€ 8,90	22 mm	302 mm	16 mm	35 mm	53 mm
BE11/23	€ 10,90	23 mm	313 mm	16 mm	36,5 mm	55 mm
BE11/24	€ 11,30	24 mm	329 mm	17,5 mm	38 mm	57 mm
BE11/25	€ 12,60	25 mm	336 mm	18 mm	39,5 mm	59,5 mm
BE11/26	€ 12,90	26 mm	348 mm	18,5 mm	41 mm	61,5 mm
BE11/27	€ 14,30	27 mm	360 mm	19 mm	42,5 mm	64 mm
BE11/28	€ 15,40	28 mm	371 mm	19,5 mm	44 mm	66 mm
BE11/29	€ 16,60	29 mm	382 mm	20 mm	45,5 mm	68 mm
BE11/30	€ 17,50	30 mm	394 mm	20 mm	47 mm	70 mm
BE11/32	€ 18,80	32 mm	415 mm	21 mm	50 mm	74 mm

BE10/08S

€ 30,80

SET OF OPEN END WRENCHES

DROP FORGED, ENTIRELY HARDENED AND TEMPERED WITH POLISHED HEAD



8 Pcs Cr-V Chromed ISO 10102 Wrapper Box

Sizes 6x7 - 8x9 - 10x11 - 12x13 - 14x15 - 16x17 - 18x19 - 20x22 mm

BE10/12S

€ 67,90

SET OF OPEN END WRENCHES

DROP FORGED, ENTIRELY HARDENED AND TEMPERED WITH POLISHED HEAD



12 Pcs Cr-V Chromed ISO 10102 Wrapper Box

Sizes 6x7 - 8x9 - 10x11 - 12x13 - 14x15 - 16x17 - 18x19 - 20x22 - 21x23 - 24x26 - 25x28 - 30x32 mm

BE11/17S

€ 80,00

SET OF COMBINATION WRENCHES

DROP FORGED, ENTIRELY HARDENED AND TEMPERED WITH POLISHED HEAD, RING PART WITH PROFILE SUITABLE FOR DAMAGED NUTS AND HEADS



17 Pcs Cr-V Chromed ISO 7738 Wrapper Box

Sizes 6 - 7 - 8 - 9 - 10 - 11 - 12 - 13 - 14 - 15 - 16 - 17 - 18 - 19 - 20 - 21 - 22 mm

BE11/26S

€ 206,00

SET OF COMBINATION WRENCHES

DROP FORGED, ENTIRELY HARDENED AND TEMPERED WITH POLISHED HEAD, RING PART WITH PROFILE SUITABLE FOR DAMAGED NUTS AND HEADS



26 Pcs Cr-V Chromed ISO 7738 Wrapper Box

Sizes 6 - 7 - 8 - 9 - 10 - 11 - 12 - 13 - 14 - 15 - 16 - 17 - 18 - 19 - 20 - 21 - 22 - 23 - 24 - 25 - 26 - 27 - 28 - 29 - 30 - 32 mm



BE20-

HEXAGONAL HEAD SCREWDRIVERS WITH T-HANDLE

ENTIRELY HARDENED AND TEMPERED BLADE WITH BLACKENED TIP, POLYPROPYLENE HANDLE

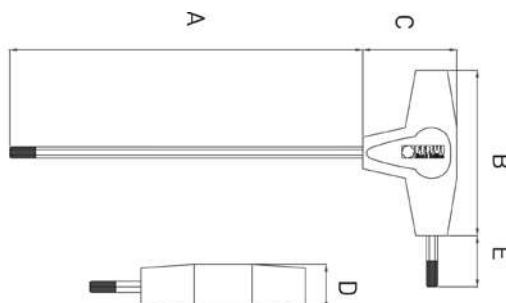

Cr-V Chromed Hanger

Art.	€	Size	A	B	C	D	E
BE20/25	€ 3,63	2.5 mm	125 mm	45 mm	32 mm	15,5 mm	15 mm
BE20/30	€ 3,58	3 mm	125 mm	45 mm	32 mm	15,5 mm	15 mm
BE20/35	€ 3,77	3.5 mm	125 mm	45 mm	32 mm	15,5 mm	15 mm
BE20/40	€ 4,50	4 mm	125 mm	45 mm	32 mm	15,5 mm	15 mm
BE20/45	€ 4,75	4.5 mm	150 mm	70 mm	40 mm	21,3 mm	20 mm
BE20/50	€ 5,00	5 mm	150 mm	70 mm	40 mm	21,3 mm	20 mm
BE20/60	€ 5,40	6 mm	150 mm	70 mm	40 mm	21,3 mm	20 mm
BE20/70	€ 7,30	7 mm	175 mm	90 mm	50 mm	28 mm	25 mm
BE20/80	€ 7,40	8 mm	175 mm	90 mm	50 mm	28 mm	25 mm
BE20/10	€ 9,50	10 mm	200 mm	90 mm	50 mm	28 mm	25 mm

BE20/10S

€ 53,60

SET OF HEXAGONAL HEAD SCREWDRIVERS WITH T-HANDLE

ENTIRELY HARDENED AND TEMPERED BLADE WITH BLACKENED TIP, POLYPROPYLENE HANDLE



10 Pcs Cr-V Chromed Wrapper Box

Sizes 2,5 - 3 - 3,5 - 4 - 4,5 - 5 - 6 - 7 - 8 - 10 mm

BE21/10S

€ 86,70

SET OF TORX SCREWDRIVERS WITH T HANDLE

ENTIRELY HARDENED AND TEMPERED BLADE WITH BLACKENED TIP, POLYPROPYLENE HANDLE



10 Pcs Cr-V Chromed Wrapper Box

Sizes T6 - T8 - T10 - T15 - T20 - T25 - T27 - T30 - T40 - T45

BE21-

TORX SCREWDRIVERS WITH T-HANDLE

ENTIRELY HARDENED AND TEMPERED BLADE WITH BLACKENED TIP, POLYPROPYLENE HANDLE

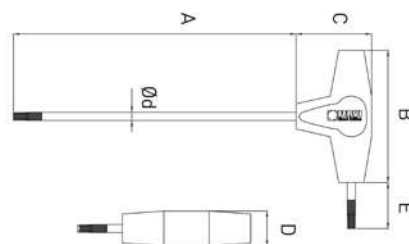

Cr-V Chromed Hanger

Art.	€	Size	ød	A	B	C	D	E
BE21/06	€ 6,00	T6	3 mm	125 mm	45 mm	32 mm	15,5 mm	15 mm
BE21/07	€ 6,20	T7	3 mm	125 mm	45 mm	32 mm	15,5 mm	15 mm
BE21/08	€ 6,20	T8	3 mm	125 mm	45 mm	32 mm	15,5 mm	15 mm
BE21/09	€ 6,20	T9	3 mm	125 mm	45 mm	32 mm	15,5 mm	15 mm
BE21/10	€ 6,20	T10	3 mm	125 mm	45 mm	32 mm	15,5 mm	15 mm
BE21/15	€ 6,90	T15	3,5 mm	125 mm	45 mm	32 mm	15,5 mm	15 mm
BE21/20	€ 7,50	T20	4 mm	125 mm	45 mm	32 mm	15,5 mm	15 mm
BE21/25	€ 7,80	T25	4,5 mm	150 mm	70 mm	40 mm	21,3 mm	20 mm
BE21/27	€ 8,30	T27	5,5 mm	150 mm	70 mm	40 mm	21,3 mm	20 mm
BE21/30	€ 9,60	T30	6 mm	150 mm	70 mm	40 mm	21,3 mm	20 mm
BE21/40	€ 9,90	T40	7 mm	175 mm	90 mm	50 mm	28 mm	25 mm
BE21/45	€ 11,80	T45	8 mm	175 mm	90 mm	50 mm	28 mm	25 mm

BE22/S9

€ 6,80

SET OF HEXAGON WRENCHES



9 Pcs Cr-Mo DIN ISO 2936 Clip in plastica

Sizes 1,5 - 2 - 2,5 - 3 - 4 - 5 - 6 - 8 - 10 mm

BE23/S9

€ 18,90

SET OF BALL END HEXAGON WRENCHES, LONG TYPE



9 Pcs Cr-Mo DIN ISO 2936 Clip in plastica

Sizes 1,5 - 2 - 2,5 - 3 - 4 - 5 - 6 - 8 - 10 mm

BE50-

FLAT SCREWDRIVERS

WITH BLACKENED TIP, HANDLE WITH ERGONOMIC SHAPE MADE WITH THREE COMPONENT MATERIAL WITH HANGING HOLE

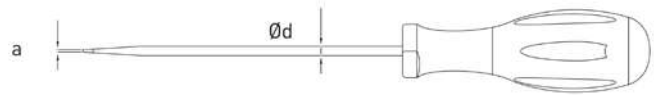
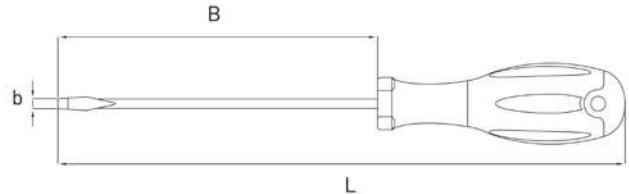

Cr-V Chromed ISO 2380-1,2 Hanger

Art.	€	a	b	B	L	Ød
BE50/2575	€ 3,20	0,4 mm	2,5 mm	75 mm	155 mm	2,5 mm
BE50/3100	€ 3,68	0,5 mm	3 mm	100 mm	180 mm	3 mm
BE50/4125	€ 4,42	0,8 mm	4 mm	125 mm	215 mm	4 mm
BE50/5515	€ 5,40	1 mm	5,5 mm	150 mm	250 mm	5 mm
BE50/6515	€ 6,80	1,2 mm	6,5 mm	150 mm	260 mm	6 mm
BE50/8175	€ 7,80	1,2 mm	8 mm	175 mm	295 mm	7 mm

BE50-2

STUBBY FLAT SCREWDRIVERS

WITH BLACKENED TIP, HANDLE WITH ERGONOMIC SHAPE MADE WITH THREE COMPONENT MATERIAL WITH HANGING HOLE

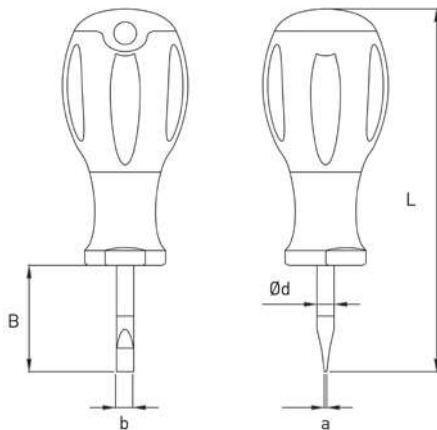

Cr-V Chromed ISO 2380-1,2 Hanger

Art.	€	a	b	B	L	Ød
BE50/4025	€ 3,68	0,8 mm	4 mm	25 mm	85 mm	4 mm
BE50/6525	€ 3,87	1,2 mm	6,5 mm	25 mm	85 mm	6,5 mm

BE51-

CROSSTIP (PH) SCREWDRIVERS

WITH BLACKENED TIP, HANDLE WITH ERGONOMIC SHAPE MADE WITH THREE COMPONENT MATERIAL WITH HANGING HOLE

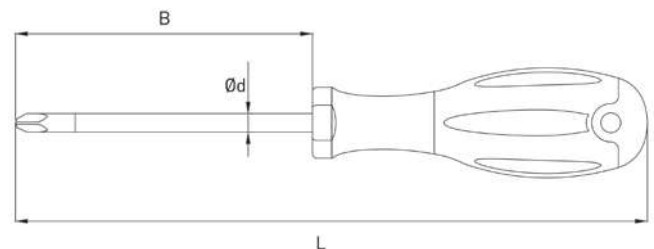

Cr-V Chromed ISO 8764-1,2 Hanger

Art.	€	Size	B	L	Ød
BE51/0060	€ 3,40	PH 0	60 mm	140 mm	3 mm
BE51/1080	€ 4,83	PH 1	80 mm	180 mm	4,5 mm
BE51/2100	€ 6,30	PH 2	100 mm	210 mm	6 mm
BE51/3150	€ 8,00	PH 3	150 mm	270 mm	8 mm



BE51/2025

€ 3,82

STUBBY CROSSTIP (PH) SCREWDRIVER

WITH BLACKENED TIP, HANDLE WITH ERGONOMIC SHAPE MADE WITH THREE COMPONENT MATERIAL WITH HANGING HOLE



Cr-V Chromed ISO 8764-1,2
Hanger

Size	PH 2
B	25 mm
L	85 mm
ød	6 mm

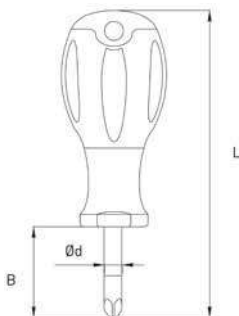

BE52/2025

€ 3,92

STUBBY DOUBLE-CROSSTIP (PZ) SCREWDRIVER

WITH BLACKENED TIP, HANDLE WITH ERGONOMIC SHAPE MADE WITH THREE COMPONENT MATERIAL WITH HANGING HOLE



Cr-V Chromed ISO 8764-1,2
Hanger

Size	PZ 2
B	25 mm
L	85 mm
ød	6 mm

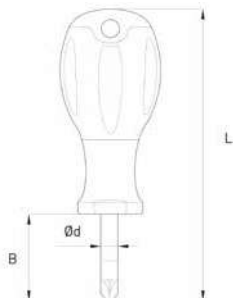

BE52-

DOUBLE-CROSSTIP (PZ) SCREWDRIVERS

WITH BLACKENED TIP, HANDLE WITH ERGONOMIC SHAPE MADE WITH THREE COMPONENT MATERIAL WITH HANGING HOLE

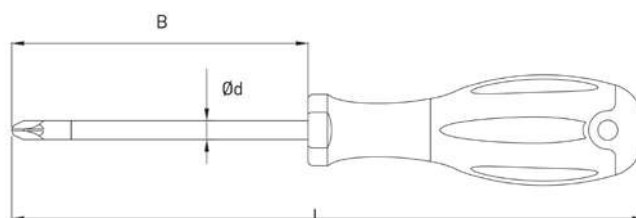

Cr-V Chromed ISO 8764-1,2 Hanger

Art.	€	Size	B	L	ød
BE52/0060	€ 3,45	PZ 0	60 mm	140 mm	3 mm
BE52/1080	€ 4,58	PZ 1	80 mm	180 mm	4,5 mm
BE52/2100	€ 5,80	PZ 2	100 mm	210 mm	6 mm
BE52/3150	€ 7,50	PZ 3	150 mm	270 mm	8 mm

BE53/07S

€ 37,40

SET OF SCREWDRIVERS

WITH BLACKENED TIP, HANDLE WITH ERGONOMIC SHAPE MADE WITH THREE COMPONENT MATERIAL WITH HANGING HOLE



Cr-V Chromed Display Box

Slotted screwdriver	0,5x3x100 - 0,8x4x125 - 1x5,5x150 - 1,2x6,5x150
Cross screwdriver	PH0x60 - PH1x80 - PH2x100



BE30-

COMBINATION PLIERS

MADE WITH SPECIAL TOOL STEEL, DROP FORGED, ENTIRELY HARDENED AND TEMPERED, INDUCTION HARDENED CUTTING EDGES, POLISHED HEAD AND HEAVY DUTY DOUBLE COMPONENT HANDLE

Chromed DIN ISO 5746 Hanger

Art.	€	L	A	B	C
BE30/16	€ 13,80	160 mm	9,5 mm	25 mm	46 mm
BE30/18	€ 14,60	180 mm	10 mm	27 mm	50 mm
BE30/20	€ 15,30	200 mm	10,5 mm	29 mm	54 mm

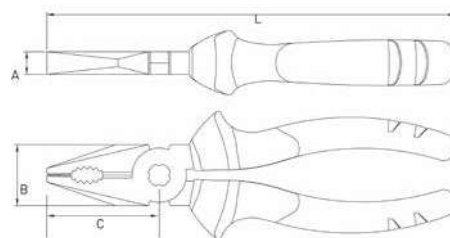

BE31-

DIAGONAL CUTTING NIPPERS

MADE WITH SPECIAL TOOL STEEL, DROP FORGED, ENTIRELY HARDENED AND TEMPERED, INDUCTION HARDENED CUTTING EDGES, POLISHED HEAD AND HEAVY DUTY DOUBLE COMPONENT HANDLE

Chromed DIN ISO 5749 Hanger

Art.	€	L	A	B	C
BE31/14	€ 12,30	140 mm	9,5 mm	19 mm	19 mm
BE31/16	€ 13,70	160 mm	10 mm	21 mm	20 mm

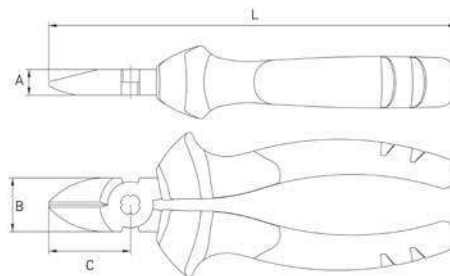

BE32-

HEAVY DUTY DIAGONAL CUTTING NIPPERS

MADE WITH SPECIAL TOOL STEEL, DROP FORGED, ENTIRELY HARDENED AND TEMPERED, INDUCTION HARDENED CUTTING EDGES, POLISHED HEAD AND HEAVY DUTY DOUBLE COMPONENT HANDLE

Chromed DIN ISO 5749 Hanger

Art.	€	L	A
BE32/18	€ 14,40	180 mm	30 mm
BE32/20	€ 16,90	200 mm	32 mm

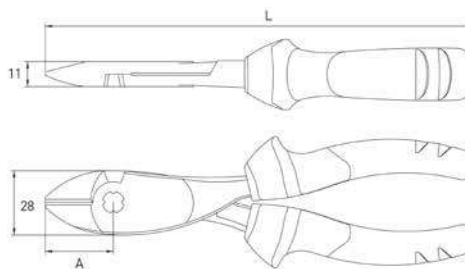

BE33-

LONG NOSE PLIERS WITH SIDE CUTTER AND PIPE GRIP, STRAIGHT

MADE WITH SPECIAL TOOL STEEL, DROP FORGED, ENTIRELY HARDENED AND TEMPERED, INDUCTION HARDENED CUTTING EDGES, SERRATED GRIPPING SURFACE, POLISHED HEAD AND HEAVY DUTY DOUBLE COMPONENT HANDLE

Chromed DIN ISO 5745 Hanger

Art.	€	L	A
BE33/17	€ 14,30	170 mm	70 mm
BE33/20	€ 15,60	200 mm	87,5 mm

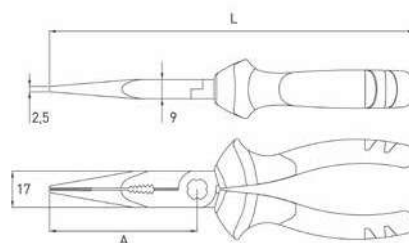

BE34-

LONG NOSE PLIERS WITH SIDE CUTTER AND PIPE GRIP, BENT

MADE WITH SPECIAL TOOL STEEL, DROP FORGED, ENTIRELY HARDENED AND TEMPERED, INDUCTION HARDENED CUTTING EDGES, SERRATED GRIPPING SURFACE, POLISHED HEAD AND HEAVY DUTY DOUBLE COMPONENT HANDLE

Chromed DIN ISO 5745 Hanger

Art.	€	L	A
BE34/17	€ 14,80	170 mm	63 mm
BE34/20	€ 16,00	200 mm	82 mm

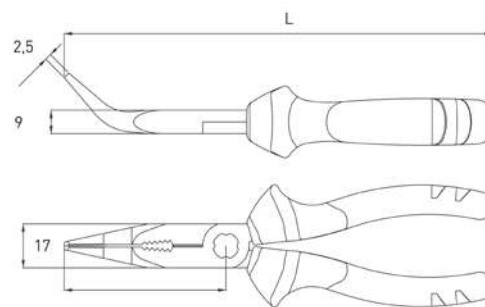

BE35-

LONG ROUND NOSE PLIERS

MADE WITH SPECIAL TOOL STEEL, DROP FORGED, ENTIRELY HARDENED AND TEMPERED, POLISHED HEAD AND HEAVY DUTY DOUBLE COMPONENT HANDLE. THEIR SPECIAL CONFORMATION ALLOWS THE REACHING OF WIRES IN HARD TO REACH PLACES WITH LESS POSSIBILITIES OF DAMAGING THEM

Chromed DIN ISO 5745 Hanger

Art.	€	L	A	B	C	D	E
BE35/14	€ 11,30	140 mm	48 mm	15 mm	2,5 mm	7,6 mm	4 mm
BE35/16	€ 11,70	160 mm	58 mm	16 mm	3 mm	8,6 mm	5 mm

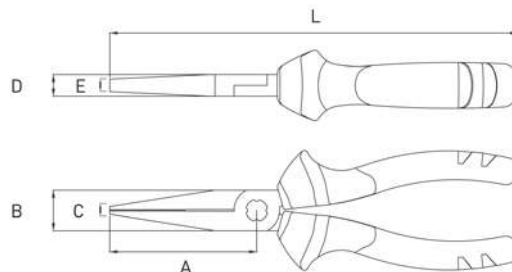

BE36-

LONG FLAT NOSE PLIERS

MADE WITH SPECIAL TOOL STEEL, DROP FORGED, ENTIRELY HARDENED AND TEMPERED, INDUCTION HARDENED CUTTING EDGES, SERRATED GRIPPING SURFACE, POLISHED HEAD AND HEAVY DUTY DOUBLE COMPONENT HANDLE

Chromed DIN ISO 5745 Hanger

Art.	€	L	A	B	C	D
BE36/14	€ 11,20	140 mm	48 mm	15 mm	2 mm	8,6 mm
BE36/16	€ 11,60	160 mm	58 mm	16 mm	2,5 mm	9,6 mm

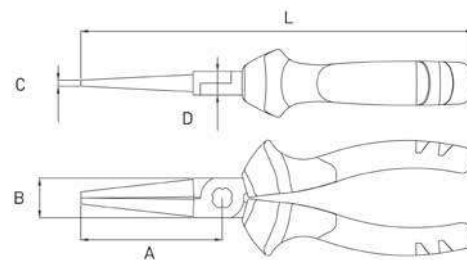

BE37-

EXTERNAL LOCK RINGS PLIERS, STRAIGHT

MADE WITH SPECIAL TOOL STEEL, DROP FORGED, ENTIRELY HARDENED AND TEMPERED, POLISHED HEAD WITH INSERTED BLACK FINISH TIPS MADE WITH HIGH RESISTANCE 58 HRC MATERIAL THAT GUARANTEE 30% HIGHER ENDURANCE IN COMPARISON TO CONVENTIONAL LOCK RINGS PLIERS, DOUBLE DIPPED PLASTIC HANDLES.

Cr-V Chromed DIN 5254A Hanger

Art.	€	L	Circlips	A
BE37/01	€ 15,30	140 mm	Ø 3 ÷ 10 mm	40 mm
BE37/02	€ 15,00	140 mm	Ø 10 ÷ 25 mm	40 mm
BE37/03	€ 16,00	180 mm	Ø 19 ÷ 60 mm	52 mm
BE37/04	€ 16,90	220 mm	Ø 40 ÷ 100 mm	63 mm

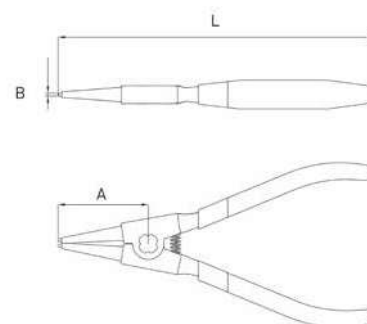

BE38-

INTERNAL LOCK RINGS PLIERS, STRAIGHT

MADE WITH SPECIAL TOOL STEEL, DROP FORGED, ENTIRELY HARDENED AND TEMPERED, POLISHED HEAD WITH INSERTED BLACK FINISH TIPS MADE WITH HIGH RESISTANCE 58 HRC MATERIAL THAT GUARANTEE 30% HIGHER ENDURANCE IN COMPARISON TO CONVENTIONAL LOCK RINGS PLIERS, DOUBLE DIPPED PLASTIC HANDLES.

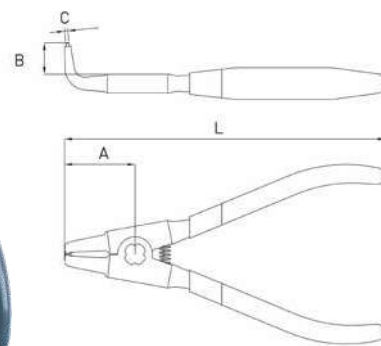

Cr-V Chromed DIN 5256C Hanger

Art.	€	L	Circlips	A
BE38/01	€ 16,10	140 mm	Ø 8 ÷ 13 mm	40 mm
BE38/02	€ 15,30	140 mm	Ø 12 ÷ 25 mm	40 mm
BE38/03	€ 16,50	180 mm	Ø 19 ÷ 60 mm	52 mm
BE38/04	€ 18,10	220 mm	Ø 40 ÷ 100 mm	63 mm

BE39-

EXTERNAL LOCK RINGS PLIERS, BENT

MADE WITH SPECIAL TOOL STEEL, DROP FORGED, ENTIRELY HARDENED AND TEMPERED, POLISHED HEAD WITH INSERTED BLACK FINISH TIPS MADE WITH HIGH RESISTANCE 58 HRC MATERIAL THAT GUARANTEE 30% HIGHER ENDURANCE IN COMPARISON TO CONVENTIONAL LOCK RINGS PLIERS, DOUBLE DIPPED PLASTIC HANDLES.

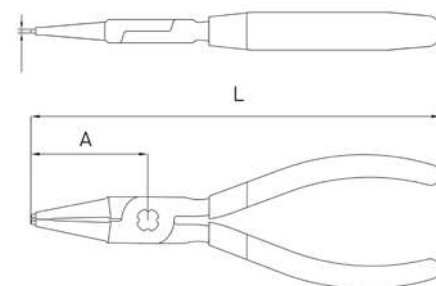

Cr-V Chromed DIN 5254B Hanger

Art.	€	Nominal size	L	Circlips	A	B
BE39/01	€ 15,40	140 mm	128 mm	Ø 3 ÷ 10 mm	28,5 mm	12,5 mm
BE39/02	€ 15,20	140 mm	128 mm	Ø 10 ÷ 25 mm	28,5 mm	12,5 mm
BE39/03	€ 16,50	180 mm	166 mm	Ø 19 ÷ 60 mm	38 mm	14 mm
BE39/04	€ 18,30	220 mm	201 mm	Ø 40 ÷ 100 mm	48,5 mm	14 mm

BE40-

INTERNAL LOCK RINGS PLIERS, BENT

MADE WITH SPECIAL TOOL STEEL, DROP FORGED, ENTIRELY HARDENED AND TEMPERED, POLISHED HEAD WITH INSERTED BLACK FINISH TIPS MADE WITH HIGH RESISTANCE 58 HRC MATERIAL THAT GUARANTEE 30% HIGHER ENDURANCE IN COMPARISON TO CONVENTIONAL LOCK RINGS PLIERS, DOUBLE DIPPED PLASTIC HANDLES.

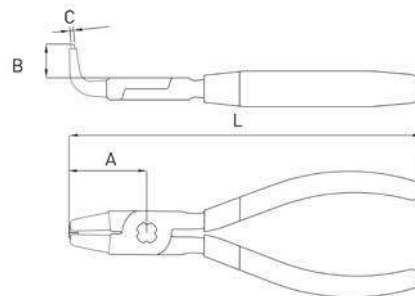

Cr-V Chromed DIN 5256D Hanger

Art.	€	Nominal size	L	Circlips	A	B
BE40/01	€ 15,40	140 mm	128 mm	Ø 8 ÷ 13 mm	28,5 mm	12,5 mm
BE40/02	€ 15,10	140 mm	128 mm	Ø 12 ÷ 25 mm	28,5 mm	12,5 mm
BE40/03	€ 15,90	180 mm	166 mm	Ø 19 ÷ 60 mm	38 mm	14 mm
BE40/04	€ 17,70	220 mm	201 mm	Ø 40 ÷ 100 mm	48,5 mm	14 mm



0690-

RATCHET FLEXIBLE HEAD COMBINATION SPANNER



Art.	€	Size
0690/08	€ 9,00	8 mm
0690/09	€ 9,00	9 mm
0690/10	€ 11,20	10 mm
0690/11	€ 11,20	11 mm
0690/12	€ 11,20	12 mm
0690/13	€ 11,20	13 mm
0690/14	€ 14,20	14 mm
0690/15	€ 14,20	15 mm
0690/16	€ 14,20	16 mm
0690/17	€ 15,30	17 mm
0690/18	€ 16,10	18 mm
0690/19	€ 17,20	19 mm

0700-

RATCHET GEAR WRENCHES



Art.	€	Size	Length
0700/08	€ 7,10	8 mm	140 mm
0700/09	€ 7,20	9 mm	150 mm
0700/10	€ 7,30	10 mm	160 mm
0700/11	€ 7,90	11 mm	165 mm
0700/12	€ 8,30	12 mm	172 mm
0700/13	€ 8,80	13 mm	180 mm
0700/14	€ 9,40	14 mm	190 mm
0700/15	€ 10,00	15 mm	220 mm
0700/16	€ 10,70	16 mm	221 mm
0700/17	€ 11,70	17 mm	225 mm
0700/18	€ 12,10	18 mm	238 mm
0700/19	€ 12,50	19 mm	248 mm

0690/07P

€ 81,80

RATCHET FLEXIBLE HEAD COMBINATION SPANNER SET



Pieces	7
Sizes	8 - 10 - 11 - 13 - 15 - 17 - 19 mm

0690/12P

€ 131,00

RATCHET FLEXIBLE HEAD COMBINATION SPANNER SET



Pieces	12
Sizes	8 - 9 - 10 - 11 - 12 - 13 - 14 - 15 - 16 - 17 - 18 - 19 mm

0700/07P

€ 57,30

RATCHET COMBINATION SPANNER SET



Sizes	8 - 10 - 11 - 13 - 15 - 17 - 19 mm
-------	------------------------------------

0700/12P

€ 103,00

RATCHET COMBINATION SPANNER SET



Sizes	8 - 9 - 10 - 11 - 12 - 13 - 14 - 15 - 16 - 17 - 18 - 19 mm
-------	--

0546

€ 43,50

SATIN FINISH COMBINATION SPANNER SET



12 Pcs Cr-V Satin finish

Set	6 ÷ 22 mm
Pieces	12
Sizes	6 - 7 - 8 - 9 - 10 - 11 - 12 - 13 - 14 - 17 - 19 - 22 mm

0544

€ 114,00

COMBINATION SPANNER SET



25 Pcs Cr-V Satin finish

Set	6 ÷ 32 mm
Pieces	25
Sizes	6-7-8-9-10-11-12-13-14-15-16-17-18-19-20-21-22-23-24-25-26-27-28-30-32 mm

0201-

DOUBLE OPEN END MIRROR POLISH LONG PATTERN WRENCH

Cr-V Chromed DIN 3110



Art.	€	Size
0201/06X07	€ 1,64	6x7 mm
0201/08X09	€ 2,15	8x9 mm
0201/10X11	€ 2,15	10x11 mm
0201/12X13	€ 3,09	12x13 mm
0201/14X15	€ 3,09	14x15 mm
0201/16X17	€ 3,83	16x17 mm
0201/18X19	€ 4,65	18x19 mm
0201/20X22	€ 5,30	20x22 mm
0201/21X23	€ 6,20	21x23 mm
0201/24X27	€ 6,70	24x27 mm

Art.	€	Size
0201/25X28	€ 8,40	25x28 mm
0201/30X32	€ 8,90	30x32 mm
0201/32X36	€ 9,80	32x36 mm
0201/34X36	€ 10,50	34x36 mm
0201/35X38	€ 11,30	35x38 mm
0201/36X41	€ 12,80	36x41 mm
0201/41X46	€ 21,80	41x46 mm
0201/46X50	€ 29,30	46x50 mm
0201/50X55	€ 42,80	50x55 mm
0201/55X60	€ 48,80	55x60 mm

0200

€ 26,40

DOUBLE OPEN END MIRROR POLISH LONG PATTERN WRENCH SET



8 Pcs Cr-V Chromed DIN 3110

Set	6 ÷ 22 mm
Sizes	6x7 8x9 10x11 12x13 14x15 16x17 18x19 20x22 mm
Pieces	8

0201

€ 61,00

DOUBLE OPEN END MIRROR POLISH LONG PATTERN WRENCH SET



12 Pcs Cr-V Chromed DIN 3110

Set	6 ÷ 32 mm
Sizes	6x7 8x9 10x11 12x13 14x15 16x17 18x19 20x22 21x23 24x27 25x28 30x32 mm
Pieces	12

0208-

MIRROR POLISH LONG PATTERN COMBINATION SPANNER



Cr-V Chromed DIN 3113

Art.	€	Size
0208/06	€ 3,09	6 mm
0208/07	€ 3,09	7 mm
0208/08	€ 3,09	8 mm
0208/09	€ 3,09	9 mm
0208/10	€ 3,17	10 mm
0208/11	€ 3,17	11 mm
0208/12	€ 3,17	12 mm
0208/13	€ 3,17	13 mm
0208/14	€ 4,73	14 mm
0208/15	€ 4,73	15 mm
0208/16	€ 4,73	16 mm
0208/17	€ 5,30	17 mm
0208/18	€ 5,30	18 mm
0208/19	€ 6,20	19 mm
0208/20	€ 7,70	20 mm
0208/21	€ 7,70	21 mm
0208/22	€ 8,90	22 mm

Art.	€	Size
0208/23	€ 9,30	23 mm
0208/24	€ 10,10	24 mm
0208/25	€ 10,10	25 mm
0208/26	€ 10,10	26 mm
0208/27	€ 11,00	27 mm
0208/28	€ 11,00	28 mm
0208/30	€ 11,00	30 mm
0208/32	€ 12,60	32 mm
0208/34	€ 13,50	34 mm
0208/36	€ 14,30	36 mm
0208/38	€ 15,80	38 mm
0208/41	€ 20,30	41 mm
0208/46	€ 27,80	46 mm
0208/50	€ 32,40	50 mm

0199

€ 43,50

MIRROR POLISH LONG PATTERN COMBINATION SPANNER SET



Cr-V Chromed DIN 3113

Set	6 ÷ 22 mm
Sizes	6-7-8-9-10-11-12-13-14-17-19-22 mm
Pieces	12

0208

€ 104,00

MIRROR POLISH LONG PATTERN COMBINATION SPANNER SET



25 Pcs Cr-V Chromed DIN 3113

Set	6 ÷ 32 mm
Sizes	6-7-8-9-10-11-12-13-14-15-16-17-18-19-20-21-22-23-24-25-26-27-28-30-32 mm
Pieces	25

0204

CAT. 42 € 133,00

MIRROR POLISH LONG PATTERN COMBINATION SPANNER SET



6 Pcs Cr-V Chromed DIN 3113

Model	34 ÷ 50
Sizes	34-36-38-41-46-50 mm



0199P-

CAT. 42

MIRROR POLISH LONG PATTERN COMBINATION SPANNER



Cr-V Chromed DIN 3113

Art.	€	Size
0199P/1/4	€ 1,83	1/4"
0199P/5/16	€ 2,00	5/16"
0199P/3/8	€ 2,50	3/8"
0199P/7/16	€ 2,58	7/16"
0199P/1/2	€ 2,58	1/2"
0199P/9/16	€ 3,25	9/16"
0199P/5/8	€ 3,75	5/8"
0199P/11/16	€ 3,92	11/16"
0199P/3/4	€ 4,42	3/4"
0199P/13/16	€ 5,30	13/16"
0199P/7/8	€ 5,80	7/8"
0199P/15/16	€ 8,40	15/16"
0199P/1	€ 8,80	1"

0199P

€ 51,40

MIRROR POLISH LONG PATTERN COMBINATION SPANNER SET



Cr-V Chromed DIN 3113

Set	1/4" ÷ 1"
Size	1/4" - 5/16" - 3/8" - 7/16" - 1/2" - 9/16" - 5/8" - 11/16" - 3/4" - 13/16" - 7/8" - 15/16" - 1"
Pieces	13

0222-

DOUBLE OPEN END WRENCH



Cr-V DIN 3110

Art.	€	Size
0222/06X07	€ 1,13	6x7 mm
0222/08X09	€ 1,31	8x9 mm
0222/10X11	€ 1,50	10x11 mm
0222/12X13	€ 1,69	12x13 mm
0222/14X15	€ 1,79	14x15 mm
0222/16X17	€ 2,16	16x17 mm
0222/18X19	€ 2,44	18x19 mm
0222/20X22	€ 2,81	20x22 mm
0222/21X23	€ 3,75	21x23 mm
0222/24X27	€ 6,20	24x27 mm
0222/25X28	€ 6,20	25x28 mm
0222/30X32	€ 6,80	30x32 mm

0221

€ 13,80

DOUBLE OPEN END WRENCH SET



8 Pcs Cr-V DIN 3110

Set	6 ÷ 22 mm
Sizes	6x7 8x9 10x11 12x13 14x15 16x17 18x19 20x22 mm
Pieces	8

0222

€ 33,40

DOUBLE OPEN END WRENCH SET



12 Pcs Cr-V DIN 3110

Set	6 ÷ 32 mm
Sizes	6x7 8x9 10x11 12x13 14x15 16x17 18x19 20x22 21x23 24x27 25x28 30x32 mm
Pieces	12

0224-

COMBINATION SPANNER

Cr-V DIN 3113

Art.	€	Size
0224/06	€ 1,04	6 mm
0224/07	€ 1,04	7 mm
0224/08	€ 1,04	8 mm
0224/09	€ 1,08	9 mm
0224/10	€ 1,13	10 mm
0224/11	€ 1,38	11 mm
0224/12	€ 1,38	12 mm
0224/13	€ 1,38	13 mm
0224/14	€ 1,71	14 mm
0224/15	€ 1,71	15 mm
0224/16	€ 1,71	16 mm
0224/17	€ 1,71	17 mm
0224/18	€ 1,71	18 mm
0224/19	€ 2,91	19 mm



Art.	€	Size
0224/20	€ 4,28	20 mm
0224/21	€ 4,50	21 mm
0224/22	€ 4,50	22 mm
0224/23	€ 4,58	23 mm
0224/24	€ 4,58	24 mm
0224/25	€ 5,00	25 mm
0224/26	€ 5,70	26 mm
0224/27	€ 6,50	27 mm
0224/28	€ 7,70	28 mm
0224/30	€ 8,20	30 mm
0224/32	€ 9,30	32 mm
0224/34	€ 10,10	34 mm
0224/36	€ 14,30	36 mm

0073

€ 15,00

COMBINATION SPANNER

CHROME - VANADIUM



12 Pcs Cr-V DIN 3113

Set	6 ÷ 22 mm
Pieces	12
Sizes	6 - 7 - 8 - 9 - 10 - 11 - 12 - 13 - 14 - 17 - 19 - 22 mm

0223

€ 59,20

COMBINATION SPANNER



25 Pcs Cr-V DIN 3113

Set	6 ÷ 32 mm
Pieces	25
Sizes	6-7-8-9-10-11-12-13-14-15-16-17-18-19-20-21-22-23-24-25-26-27-28-30-32 mm

0476-

RING SPANNERS

CHROMED AND MIRROR POLISH

Cr-V Chromed DIN 838

Art.	€	Size
0476/06X07	€ 1,89	6 x 7 mm
0476/08X09	€ 2,06	8 x 9 mm
0476/10X11	€ 2,15	10 x 11 mm
0476/12X13	€ 2,24	12 x 13 mm
0476/14X15	€ 2,75	14 x 15 mm
0476/16X17	€ 3,09	16 x 17 mm



Art.	€	Size
0476/18X19	€ 3,42	18 x 19 mm
0476/20X22	€ 4,80	20 x 22 mm
0476/21X23	€ 5,20	21 x 23 mm
0476/24X27	€ 6,70	24 x 27 mm
0476/25X28	€ 7,70	25 x 28 mm
0476/30X32	€ 9,30	30 x 32 mm

0477

€ 23,20

RING SPANNER SET

6 ÷ 22 mm, CHROMED AND MIRROR POLISH



8 Pcs Cr-V Chromed DIN 838

Set	6 ÷ 22 mm
Pieces	8
Sizes	6x7 8x9 10x11 12x13 14x15 16x17 18x19 20x22 mm

0476

€ 53,20

RING SPANNER SET

6÷32 mm CHROMED AND MIRROR POLISH



12 Pcs Cr-V Chromed DIN 838

Set	6 ÷ 32 mm
Pieces	12
Sizes	6x7 8x9 10x11 12x13 14x15 16x17 18x19 20x22 21x23 24x27 25x28 30x32 mm

0895-

CAT. 42

PERCUSSION OPEN WRENCHES

DIN133

Art.	€	Size
0895/24	€ 10,70	24 mm
0895/27	€ 11,50	27 mm
0895/30	€ 12,80	30 mm
0895/32	€ 13,80	32 mm
0895/36	€ 16,30	36 mm
0895/38	€ 18,30	38 mm
0895/41	€ 20,80	41 mm
0895/46	€ 23,70	46 mm
0895/50	€ 32,40	50 mm
0895/55	€ 37,50	55 mm
0895/60	€ 45,00	60 mm
0895/65	€ 63,30	65 mm
0895/70	€ 79,20	70 mm



0896-

CAT. 42

POLYGONAL PERCUSSION WRENCHES

DIN 7444

Art.	€	Size
0896/24	€ 10,70	24 mm
0896/27	€ 11,50	27 mm
0896/30	€ 12,80	30 mm
0896/32	€ 13,80	32 mm
0896/36	€ 16,30	36 mm
0896/38	€ 18,30	38 mm
0896/41	€ 20,80	41 mm
0896/46	€ 23,70	46 mm
0896/50	€ 29,20	50 mm
0896/55	€ 33,30	55 mm
0896/60	€ 40,80	60 mm
0896/65	€ 59,20	65 mm
0896/70	€ 74,20	70 mm



0196-

CAT. 42

STUBBY MIRROR POLISH COMBINATION SPANNERS

Cr-V Chromed

Art.	€	Size
0196/10	€ 1,92	10 mm
0196/11	€ 2,08	11 mm
0196/12	€ 2,25	12 mm
0196/13	€ 2,50	13 mm
0196/14	€ 2,67	14 mm
0196/15	€ 2,92	15 mm
0196/16	€ 3,08	16 mm
0196/17	€ 3,17	17 mm
0196/18	€ 3,42	18 mm
0196/19	€ 3,50	19 mm



0196

€ 21,80

STUBBY MIRROR POLISH COMBINATION SPANNER SET



10 Pcs Cr-V Chromed

Set	10 ÷ 19 mm
Sizes	10-11-12-13-14-15-16-17-18-19 mm

0187

€ 31,70

MULTILOCK COMBINATION SPANNER SET

MULTILOCK COMBINATION SPANNER SET, SUITABLE FOR METRIC, INCH, TORX AND XZN BOLT

8 Pcs Cr-V

Sizes	8 - 10 - 11 - 12 - 13 - 14 - 17 - 19 mm
Inch size	5/16" - 3/8" - 7/16" - 15/32" - 1/2" - 9/16" - 11/16" - 3/4"
Torx size	E10 - E12 - E14 - E16 - E18 - E22 - E24
XZN size	M8 - M10 - M11 - M12 - M13 - M14 - M17 - M19



0134-

CAT. 42

FLAT POLYGONAL WRENCH

Cr-V DIN 837

Art.	€	Size	Length
0134/06X07	€ 3,00	6 x 7 mm	100 mm
0134/08X09	€ 3,33	8 x 9 mm	115 mm
0134/10X11	€ 3,50	10 x 11 mm	130 mm
0134/12X13	€ 3,75	12 x 13 mm	145 mm
0134/14X15	€ 4,08	14 x 15 mm	160 mm
0134/16X17	€ 4,50	16 x 17 mm	170 mm
0134/18X19	€ 4,83	18 x 19 mm	185 mm
0134/20X22	€ 5,40	20 x 22 mm	205 mm



0134S

€ 26,40

FLAT RING SPANNER SET

DOUBLE FLAT RINGS

8 Pcs Cr-V DIN 837 Box

Set	6 ÷ 22 mm
Sizes	100 - 6x7 mm, 115 - 8x9 mm, 130 - 10x11 mm, 145 - 12x13 mm, 160



0614-

HALF MOON RING SPANNERS

Cr-V DIN 838

Art.	€	Size
0614/08X10	€ 3,75	8 x 10 mm
0614/10X12	€ 4,06	10 x 12 mm
0614/11X13	€ 4,38	11 x 13 mm
0614/13X15	€ 4,69	13 x 15 mm
0614/14X17	€ 5,60	14 x 17 mm
0614/16X18	€ 6,90	16 x 18 mm
0614/19X22	€ 7,50	19 x 22 mm



0614

CAT. 42 € 37,50

SET OF HALF MOON RING SPANNERS



7 Pcs Cr-V DIN 838

Model	8 ÷ 22 mm
Sizes	8x10 - 10x12 - 11x13 - 13x15 - 14x17 - 16x18 - 19x22 mm

0541S

€ 24,20

FLARE NUT WRENCH SET

6 POINT FROM 8 mm TO 14 mm, 12 POINT FROM 17 mm TO 22 mm



6 Pcs Cr-V DIN 3118 Box

Set	8 ÷ 22 mm
Pcs	6
Sizes	140 - 8x10 mm, 150 - 9x11 mm, 175 - 11x13 mm, 175 - 12x14 mm, 210 - 17x19 mm, 220 - 19x22 mm

0084-

ADJUSTABLE WRENCHES



Art.	€	Size	Opening
0084/150	€ 4,50	6" - 150 mm	18 mm
0084/250	€ 7,90	10" - 250 mm	30 mm
0084/375	€ 22,40	15" - 375 mm	48 mm

0340S

CAT. 42 € 48,30

DOUBLE HEAD SOCKET WRENCH SET

IDEAL FOR LOOSEN AND TIGHTEN NUTS AND BOLTS LOCATED IN POSITIONS HARD TO GET



Chromed Cr-V

Set	8 ÷ 19 mm
Sizes	8x9-10x11-12x13-14x15-16x17-18x19 mm
Pieces	6

0442

€ 73,30

HEXAGONAL TUBULAR SOCKET WRENCH SET

CHROMED MIRROR POLISH WITH HEXAGONAL BODY



8 Pcs Cr-V

Sizes	105 - 6x7 mm, 110 - 8x9 mm, 120 - 10x11 mm, 140 - 12x13 mm, 145 - 14x15 mm, 155 - 16x17 mm, 165 - 18x19 mm, 170 - 20x22 mm
-------	--

0442-

HEXAGONAL TUBULAR SOCKET WRENCHES

CHROMED MIRROR POLISH WITH HEXAGONAL BODY

Cr-V

Art.	€	Size	Length
0442/06X07	€ 5,60	6 x 7 mm	105 mm
0442/08X09	€ 6,00	8 x 9 mm	110 mm
0442/10X11	€ 6,50	10 x 11 mm	120 mm
0442/12X13	€ 7,30	12 x 13 mm	140 mm
0442/14X15	€ 8,20	14 x 15 mm	145 mm
0442/16X17	€ 9,30	16 x 17 mm	155 mm
0442/18X19	€ 11,40	18 x 19 mm	165 mm
0442/20X22	€ 14,30	20 x 22 mm	170 mm



0540-

HEXAGONAL TUBULAR SOCKET WRENCH

LIGHT MODEL

Art.	€	Size	Length
0540/06X07	€ 1,75	6 x 7 mm	110 mm
0540/08X09	€ 1,85	8 x 9 mm	120 mm
0540/10X11	€ 1,88	10 x 11 mm	125 mm
0540/12X13	€ 2,00	12 x 13 mm	135 mm
0540/14X15	€ 2,13	14 x 15 mm	135 mm
0540/16X17	€ 2,50	16 x 17 mm	150 mm
0540/18X19	€ 2,81	18 x 19 mm	160 mm
0540/20X22	€ 3,13	20 x 22 mm	170 mm



0540S

€ 15,30

HEXAGONAL TUBULAR SOCKET WRENCH SET

LIGHT MODEL, WITH TOMMY BAR



Set	6 ÷ 22 mm
Sizes	6x7 8x9 10x11 12x13 14x15 16x17 18x19 20x22 mm

0540/3

€ 2,50

TOMMY BAR

3 STEP



Hanger

Length	165 mm
Ø	9,5 - 7,5 - 6 mm

0266

€ 1,30

GAS SPANNER

CHROME PLATED



8 Pcs

Size	25 mm
------	-------



0215x

BALL POINT HEX KEY SET , LONG TYPE



9 Pcs Cr-V Satin finish

Art.	€	Size
0215	€ 9,80	1,5-2-2,5-3-4-5-6-8-10
0215P	€ 9,80	1/16" 5/64" 3/32" 1/8" 5/32" 3/16" 1/4" 5/16" 3/8"

0558/EP

CAT. 42 € 14,50

HEX KEY SET WITH DIAMOND TIP

THE DIAMOND TIP ALLOWS A PERFECT GRIP, AVOIDING TO RUIN THE HEAD OF THE SCREW. THIS TYPE OF TIP IS ALSO VERY EFFECTIVE WITH ALREADY RUINED SCREWS.



9 Pcs Cr-V S2 Hanger

Sizes	5/64" - 3/32" - 7/64" - 1/8" - 9/64" - 5/32"
-------	--

0545/EF

CAT. 42 € 27,10

COLORED HEX KEY SERIES



9 Pcs Mo-V Blister

Sizes	1.5 - 2 - 2.5 - 3 - 4 - 5 - 6 - 8 - 10 mm
-------	---

0558/EM

CAT. 42 € 14,50

HEX KEY SET WITH DIAMOND TIP

THE DIAMOND TIP ALLOWS A PERFECT GRIP, AVOIDING TO RUIN THE HEAD OF THE SCREW. THIS TYPE OF TIP IS ALSO VERY EFFECTIVE WITH ALREADY RUINED SCREWS.



8 Pcs Cr-V S2 Hanger

Sizes	1,5 - 2 - 2,5 - 3 - 4 - 5 - 6 - 8 mm
-------	--------------------------------------

0558/GE

CAT. 42 € 11,50

HEX KEY SET

WITH PH AND SLOT SCREWDRIVER HEAD, WITH MULTIPURPOSE HANDLE THAT CAN BE USED AS A T-HANDLE OR AS A KEY EXTENSION.



8 Pcs Cr-V Matte black Blister

Sizes	2-2,5-3-4-5-6-8-10 mm
Cross screwdriver	PH0 (3mm) - PH1 (4mm) - PH2 (5mm)
Slotted screwdriver	6mm



0856-

TWO WAY HEX KEY WITH ANATOMIC PLASTIC HANDLE



CAT. 42

Cr-V

Art.	€	Overall sizes
0856/02	€ 2,08	2x100 mm
0856/02.5	€ 2,08	2,5x100 mm
0856/03	€ 2,17	3x100 mm
0856/04	€ 2,33	4x100 mm
0856/05	€ 3,25	5x150 mm
0856/06	€ 3,58	6x150 mm
0856/08	€ 5,00	8x200 mm
0856/10	€ 5,20	10x200 mm

C856-

TWO WAY HEX KEY WITH PLASTIC HANDLE



€ 55,00

Cr-V Phosphated

Art.	€	Size
C856/02.5	€ 3,33	2.5 mm
C856/03	€ 3,33	3 mm
C856/04	€ 3,50	4 mm
C856/05	€ 3,75	5 mm
C856/06	€ 5,30	6 mm
C856/08	€ 5,80	8 mm
C856/10	€ 8,00	10 mm

0400

MALE "T" HANDLE HEX WRENCH SET

WITH SLIDING BAR MAKING THEM VERSATILE FOR USE IN DIFFICULT SITUATIONS AND UNDER EXTREME CONDITIONS

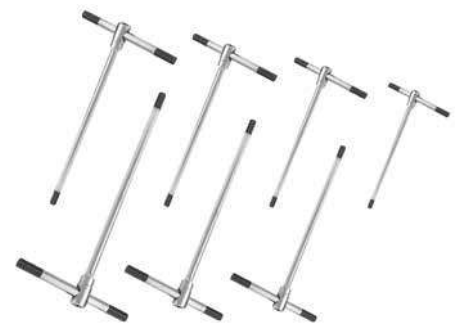

7 Pcs Cr-V

Sizes	2 - 3 - 4 - 5 - 6 - 8 - 10 mm
-------	-------------------------------

0400-

MALE "T" HANDLE HEX WRENCHES

3,5 mm, WITH SLIDING BAR MAKING IT VERSATILE FOR USE IN DIFFICULT SITUATIONS AND UNDER EXTREME CONDITIONS

Cr-V

Art.	€	Size	Dimensions	Art.	€	Size	Dimensions
0400/02	€ 7,20	2 mm	125 x 65 mm	0400/06	€ 8,10	6 mm	210 x 105 mm
0400/025	€ 7,20	2,5 mm	125 x 65 mm	0400/07	€ 8,10	7 mm	250 x 105 mm
0400/03	€ 7,20	3 mm	125 x 65 mm	0400/08	€ 9,30	8 mm	250 x 125 mm
0400/035	€ 7,20	3,5 mm	125 x 65 mm	0400/09	€ 11,30	9 mm	300 x 145 mm
0400/04	€ 7,70	4 mm	180 x 90 mm	0400/10	€ 11,30	10 mm	300 x 145 mm
0400/045	€ 7,70	4,5 mm	180 x 90 mm	0400/12	€ 16,00	12 mm	320 x 165 mm
0400/05	€ 7,70	5 mm	180 x 90 mm	0400/14	€ 20,50	14 mm	340 x 170 mm



0190

€ 61,70

3-WAY SPEEDY HEX KEY WRENCH SET

WITH PRACTICAL "SPEEDY" ROTATING HANDLE FOR INCREASED WORKING VELOCITY



7 Pcs

Set	2 ÷ 10 mm
Sizes	2 - 3 - 4 - 5 - 6 - 8 - 10 mm

0269

€ 4,58

HEX KEY SET



9 Pcs Cr-V

Sizes	1,5 - 2 - 2,5 - 3 - 4 - 5 - 6 - 8 - 10 mm
-------	---

0090-

MALE HEX KEY SET

PACKING OF 10* PIECES UNTIL 6 MM, PACKING OF 5* PIECES FROM 8 MM

Cr-V Zinc plated DIN 911

Art.	€	L1	L2
0090/015	€ 0,53	45 mm	14 mm
0090/02	€ 0,53	50 mm	16 mm
0090/025	€ 0,53	56 mm	18 mm
0090/03	€ 0,57	63 mm	20 mm
0090/04	€ 0,57	70 mm	25 mm
0090/05	€ 0,86	80 mm	28 mm
0090/06	€ 1,04	90 mm	32 mm



Art.	€	L1	L2
0090/08	€ 1,55	100 mm	36 mm
0090/10	€ 1,89	112 mm	40 mm
0090/12	€ 2,91	125 mm	45 mm
0090/14	€ 4,13	140 mm	56 mm
0090/17	€ 5,40	160 mm	63 mm
0090/19	€ 8,70	180 mm	70 mm

0090

€ 2,33

HEX KEY SET



10 Pcs

Sizes	1,5 - 2 - 2,5 - 3 - 3,5 - 4 - 5 - 6 - 8 - 10 mm
-------	---

0220

€ 11,60

TORX KEY SET LONG TYPE

WITH TAMPER RESISTANT HEAD (HOLE)



9 Pcs Cr-V Satin finish

Sizes	T10 - T15 - T20 - T25 - T27 - T30 - T40 - T45 - T50
-------	---

0545/TF

CAT. 42 € 29,20

COLORED TORX KEY SERIES



9 Pcs Mo-V Blister

Sizes T10 - T15 - T20 - T25 - T27 - T30 - T40 - T45 - T50

0558/TX

CAT. 42 € 14,50

TORX KEY SET WITH DIAMOND TIP

THE DIAMOND TIP ALLOWS A PERFECT GRIP, AVOIDING TO RUIN THE HEAD OF THE SCREW. THIS TYPE OF TIP IS ALSO VERY EFFECTIVE WITH ALREADY RUINED SCREWS.



8 Pcs Cr-V S2 Hanger

Sizes T9 - T10 - T15 - T20 - T25 - T27 - T30 - T40

0210

€ 3,73

TORX KEY SET



8 Pcs

Sizes T9 - T10 - T15 - T20 - T25 - T27 - T30 - T40

0855-

TWO WAY TORX AND TAMPERED KEY WITH ANATOMIC PLASTIC HANDLE



Cr-V

Art.	€	Overall sizes
0855/T10	€ 2,08	T10x100 mm
0855/T15	€ 2,08	T15x100 mm
0855/T20	€ 2,33	T20x100 mm
0855/T25	€ 2,75	T25x100 mm
0855/T30	€ 3,25	T30x150 mm
0855/T40	€ 4,17	T40x150 mm



C855-

CAT. 42

TWO WAY TORX KEY WITH PLASTIC HANDLE

Cr-V Phosphated

Art.	€	Size
C855/T10	€ 3,33	T10
C855/T15	€ 3,33	T15
C855/T20	€ 3,75	T20
C855/T25	€ 4,42	T25
C855/T27	€ 4,42	T27
C855/T30	€ 5,30	T30
C855/T40	€ 6,70	T40
C855/T50	€ 7,90	T50



0405

€ 55,70

MALE "T" HANDLE TORX WRENCH SET

WITH SLIDING BAR MAKING THEM VERSATILE FOR USE IN DIFFICULT SITUATIONS AND UNDER EXTREME CONDITIONS

7 Pcs Cr-V

Sizes T8-T9-T10-T15-T20-T25-T30



0405-

MALE "T" HANDLE TORX WRENCH

WITH SLIDING BAR MAKING IT VERSATILE FOR USE IN DIFFICULT SITUATIONS AND UNDER EXTREME CONDITIONS

Cr-V

Art.	€	Sizes
0405/T06	€ 8,20	125 x 65 mm
0405/T07	€ 8,20	125 x 65 mm
0405/T08	€ 8,20	125 x 65 mm
0405/T09	€ 8,20	125 x 65 mm
0405/T10	€ 8,20	125 x 65 mm
0405/T15	€ 8,20	125 x 65 mm
0405/T20	€ 8,20	125 x 65 mm

Art.	€	Sizes
0405/T25	€ 8,40	180 x 90 mm
0405/T27	€ 8,40	180 x 90 mm
0405/T30	€ 8,40	180 x 90 mm
0405/T40	€ 10,10	210 x 105 mm
0405/T45	€ 11,00	210 x 105 mm
0405/T50	€ 11,80	210 x 105 mm



0359-

CAT. 42

T-HANDLE SPARK PLUG SOCKET WRENCH

Cr-V Sacco di plastica

Art.	€	Size	Length	Handle length
0359/14L	€ 19,20	14 mm	530 mm	200 mm
0359/16L	€ 19,20	16 mm	530 mm	200 mm
0359/21L	€ 20,80	20,8 mm	530 mm	200 mm
0359/16	€ 15,80	16 mm	275 mm	200 mm



007x

SPAR K PLUG WRENCH

 DIN 899

Art.	€	Size	Length
0078	€ 5,80	20,8	500 mm
0079	€ 5,80	16 mm	510 mm



C245-

T-HANDLE DEEP SOCKET WRENCHES

 Cr-V  Satin finish

Art.	€	Size	Length
C245/06	€ 11,70	6 mm	320 mm
C245/07	€ 11,70	7 mm	320 mm
C245/08	€ 11,70	8 mm	320 mm
C245/09	€ 11,70	9 mm	320 mm
C245/10	€ 12,10	10 mm	320 mm
C245/11	€ 12,10	11 mm	320 mm
C245/12	€ 12,50	12 mm	320 mm
C245/13	€ 12,50	13 mm	320 mm
C245/14	€ 13,30	14 mm	320 mm
C245/17	€ 15,40	17 mm	320 mm
C245/19	€ 19,20	19 mm	320 mm



C395-

T HANDLE MAGNETIC SWIVEL HEX SOCKET

 Cr-V

Art.	€	Hexagon	Length
C395/06	€ 14,60	6 mm	390 mm
C395/07	€ 14,60	7 mm	390 mm
C395/08	€ 14,60	8 mm	390 mm
C395/09	€ 14,60	9 mm	390 mm
C395/10	€ 16,50	10 mm	500 mm
C395/11	€ 16,50	11 mm	500 mm
C395/12	€ 16,50	12 mm	500 mm
C395/13	€ 17,30	13 mm	500 mm
C395/14	€ 17,30	14 mm	500 mm
C395/15	€ 19,60	15 mm	500 mm
C395/16	€ 19,60	16 mm	500 mm
C395/17	€ 19,60	17 mm	500 mm
C395/18	€ 20,40	18 mm	500 mm
C395/19	€ 21,70	19 mm	500 mm



C391-

T-HANDLE SWIVEL HEX SOCKET

HEAVY DUTY

 Cr-V

Art.	€	Size	Length
C391/06	€ 16,70	6 mm	395 mm
C391/07	€ 16,70	7 mm	395 mm
C391/08	€ 16,70	8 mm	395 mm
C391/09	€ 16,70	9 mm	400 mm
C391/10	€ 18,30	10 mm	400 mm
C391/11	€ 18,30	11 mm	400 mm
C391/12	€ 18,30	12 mm	400 mm
C391/13	€ 20,00	13 mm	432 mm
C391/14	€ 20,00	14 mm	432 mm
C391/15	€ 24,20	15 mm	450 mm
C391/16	€ 24,20	16 mm	450 mm
C391/17	€ 24,20	17 mm	450 mm
C391/18	€ 24,20	18 mm	450 mm
C391/19	€ 26,70	19 mm	500 mm



0352-

BELT OIL FILTER WRENCH



Art.	€	Filter maximum diameter	Belt
0352/01	€ 16,50	180 mm	700 mm
0352/02	€ 17,90	250 mm	900 mm

0076

TAPE OIL FILTER WRENCH

€ 3,75

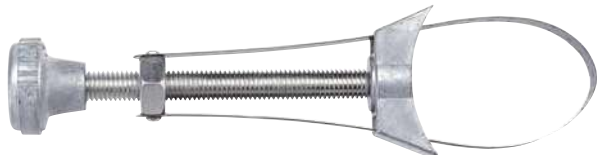

0357-

OIL FILTER STEEL BELT WRENCH



Art.	€	Belt
0357/01	€ 19,00	180 mm
0357/02	€ 20,70	200 mm

0077

OIL FILTER CHAIN WRENCH

€ 5,00



0018/15

OIL FILTER WRENCH SET

USEFUL FOR THE REMOVAL OF OIL FILTERS FOR MANY VEHICLES. AN ADAPTER WITH 3/8" MALE AND 1/2" FEMALE DRIVES IS INCLUDED IN THE SET.

€ 53,20

15 Pcs 3/8" Carbon steel Plastic case

Sizes (ø mm - sides) 65 mm - 14, 65/67 mm - 14, 68 mm - 14, 74 mm - 15, 74/76 mm - 15, 75/77 mm - 15, 76 mm - 14, 76 mm - 30, 80 mm - 15, 80/82 mm - 15, 90 mm - 15, 93 mm - 15, 93 mm - 36, 100 mm - 15

Adapter drive 1/2" (F) 3/8" (M)



0018/30

OIL FILTER WRENCH SET

USEFUL FOR THE REMOVAL OF OIL FILTERS FOR MANY VEHICLES. AN ADAPTER WITH 3/8" MALE AND 1/2" FEMALE DRIVES AND A 3-JAW WRENCH ARE INCLUDED IN THE SET.

€ 118,00

28 Pcs 3/8" Carbon steel Plastic case

Sizes (ø mm - sides) 65 mm - 14, 65/67 mm - 14, 66 mm - 6, 68 mm - 14, 73 mm - 14, 74 mm - 15, 74/76 mm - 15, 75/77 mm - 15, 76 mm - 8, 76 mm - 12, 76 mm - 14, 76 mm - 30, 78 mm - 15, 80 mm - 15, 80/82 mm - 15, 86 mm - 16, 86 mm - 18, 90 mm - 15, 92 mm - 10, 93 mm - 15, 93 mm - 15, 93 mm - 36, 93 mm - 45, 95 mm - 15, 96 mm - 18, 100 mm - 15, 106 mm - 15, 108 mm - 15, 108 mm - 18

Adapter drive 1/2" (F) 3/8" (M)

3 - Jaw wrench 65 ÷ 120 mm



0080

€ 7,70

CROSS RIM WRENCH

1/2" MALE DRIVE



DIN 899 Zinc plated steel

Sizes	17 - 19 - 21 mm
Overall sizes	381 x 16 mm

0426-

CROSS RIM WRENCH

FOR LIGHT TRUCKS, WITH FIXED HEX SOCKETS AND 3/4" MALE DRIVE



Zinc plated steel

Art.	€	Sizes	Dimensions
0426/30	€ 27,80	24 - 27 - 30 mm	550 x 20 mm
0426/32	€ 35,20	24 - 27 - 32 mm	700 x 22 mm

0451

€ 29,70

DETACHABLE CROSS RIM WRENCH

CONSISTING OF 2 HEX SOCKETS WITH 4 SIZES, BAR AND SPINNING HANDLE.



Cr-V 1/2"

Sockets sizes	17 - 19 - 21 - 23 mm
Bar dimensions	ø15 x 400 mm
Handle length	330 mm

0806/200

€ 368,00

ELECTRONIC DIGITAL TORQUE - ANGLE WRENCH

IT ALLOWS CW AND CCW OPERATION AND A LED AND BUZER DIAGNOSTIC OF TORQUE/ANGLE STATUS.

1/2" Plastic case

MEASURE UNITS:	Nm / kgm / lbft / lbin
Capacity	20 ÷ 200 Nm
Reading	0,1 Nm
Accuracy	±2%, 10% @ 200 Nm
Angle range	0 ÷ 360°
Angle accuracy	±1%
Operation mode	Peak / Track
Torque memories - Angle	5
Length	605 mm
Battery	4x 1,5 V AAA
Weight	1,5 kg



0270

€ 225,00

DIGITAL TORQUE WRENCH FOR WHEEL

DISPLAY ON A SIDE TO READ BETTER THE TORQUE FORCE

1/2" Blow mold case

MEASURE UNITS:	Nm
Preset torque values	90, 110, 135, 160, 190 Nm
Accuracy	0.1 Nm
LED number	3
Dr.	1/2"
Teeth	36
Working temperature	0°C; + 50°C; (31°F; + 122°F;)
Auto power off	80"
Not included batteries	3 x AAA
Autonomy	110 h
Weight	1.75 kg



0809-

ELECTRONIC DIGITAL TORQUE WRENCH

ELECTRONIC DIGITAL TORQUE WRENCH, IT ALLOWS CW AND CCW OPERATION AND A LED AND BUZER DIAGNOSTIC OF TORQUE STATUS.



Plastic case

Art.	€	MEASURE UNITS:	Capacity	Reading	Accuracy	Operation mode	Memory	Dr.	Length	Battery	Weight
0809/030	€ 87,50	Nm / kgf-cm / lbf-ft / lbf-in	6 ÷ 30 Nm	0,01 Nm	±4%	Peak / Track	50	1/4"	200 mm	2 x 3 V CR2032	0,26 kg
0809/080	€ 93,30	Nm / kgf-m / lbf-ft / lbf-in	16 ÷ 80 Nm	0,1 Nm	±3%	Peak / Track	50	3/8"	230 mm	2 x 3 V CR2032	0,45 kg
0809/100	€ 98,30	Nm / kgf-m / lbf-ft / lbf-in	20 ÷ 100 Nm	0,1 Nm	±2%	Peak / Track	50	1/2"	275 mm	2 x 3 V CR2032	0,68 kg

0806/020

€ 90,00

DIGITAL TORQUE SCREWDRIVER

IT ALLOWS CW AND CCW OPERATION, VIBRATION AND BUZZER DIAGNOSTIC OF TARGET TORQUE REACHED



MEASURE UNITS:	Nm / lbft / lbin
Capacity	0 ÷ 20 Nm
Reading	0,01 Nm
Accuracy	±2%
Operation mode	Peak / Track
Auto power off	5 min.
Hex drive	1/4"
Length	175 mm
Battery	2 x 1,5 V AAA
Weight	0,25 kg

0268

€ 77,00

DIGITAL TORQUE WRENCH

1/2" Plastic case

MEASURE UNITS:	Nm / kgm / kgcm / lbft / lbin
Capacity	40 ÷ 200 Nm
Reading	0,1 Nm
Operation mode	Peak / Track
Memory	50
Accuracy	±2%
Overall sizes	75 x 44 mm
Battery	1 x CR2032
Weight	0,25 kg



0137

€ 50,40

TORQUE WRENCH



Cr-V

Dr.	1/2" - 3/8"
Capacity	28 ÷ 210 Nm
Extension	120 mm



0815/100

CAT. 42

TORQUE WRENCH



Cr-Mo

Art.	€	Dr.	Capacity	Length
0815/100	€ 133,00	3/8"	20 ÷ 100 Nm	460 mm
0815/200	€ 175,00	1/2"	40 ÷ 200 Nm	515 mm
0815/800	€ 608,00	3/4"	100 ÷ 800 Nm	1100 mm

0803-

CAT. 42

TORQUE WRENCHES



Cr-V

Art.	€	Capacity	Length	Shank	Accuracy
0803/110	€ 114,00	20 - 110 Nm	380 mm	3/8"	±4%
0803/210	€ 164,00	40 - 210 Nm	535 mm	1/2"	±4%
0803/700	€ 533,00	140 - 700 Nm	1085 mm	3/4"	±4%

0803/S210

€ 262,00

TORQUE WRENCH SET



11 Pcs Cr-V

Capacity	40 ÷ 210 Nm
Accuracy	±4%
Spanner head	13 - 14 - 15 - 17 - 19 - 22 - 24 - 27 - 30 mm
Spanners shank	14 x 18 mm
Ratchet head	1/2"

0803/S080

€ 178,00

TORQUE WRENCH SET

8 Pcs Cr-V

Capacity	15 ÷ 80 Nm
Accuracy	±4%
Spanner head	17 - 22 - 24 - 26 - 27 - 30 mm
Spanners shank	14x 18 mm
Ratchet head	3/8"



0329

€ 141,00

TORQUE MULTIPLIER

LABOR SAVING WHEEL WRENCH.

Plastic case

1" Dr. sockets	32 - 33 mm
Ratio	1:60
Maximum torque	3200 Nm
Operating torque	1200 Nm
Weight	8,3 kg



0360

€ 64,20

TORQUE MULTIPLIER

LABOR SAVING WHEEL WRENCH, SUPPLIED IN PLASTIC CASE

Plastic case

1" Dr. sockets	32 - 33 mm
Ratio	1 : 56
Maximum torque	3000 Nm
Operating torque	1000 Nm
Weight	7,1 kg



CN450N/0

€ 37,50

3 IN 1 QUICK CHANGE DRIVE RATCHET HANDLE

WITH RELIABLE, STRONG 1/2", 3/8" AND 1/4" DRIVES. EASY TO CHANGE



Cr-V & Cr-Mo Storage case

Shank	1/2", 3/8", 1/4"
Length	230 mm
Teeth	72

G090-

ERGONOMIC RATCHET HANDLE

HANGER



Cr-V & Cr-Mo

Art.	€	Dr.	Length	Teeth	Weight
G090/1/4	€ 17,30	1/4"	145 mm	90	115 g
G090/3/8	€ 21,00	3/8"	195 mm	90	245 g
G090/1/2	€ 24,00	1/2"	265 mm	90	470 g

F090-

ERGONOMIC RATCHET HANDLE

WITH HANGER



Cr-V & Cr-Mo

Art.	€	Dr.	Length	Teeth	Weight
F090/1/4	€ 17,30	1/4"	145 mm	90	115 g
F090/3/8	€ 21,00	3/8"	195 mm	90	245 g
F090/1/2	€ 24,00	1/2"	265 mm	90	470 g

0494-

DUST PROOF ERGONOMIC RATCHET HANDLE



72 denti-teeth Cr-V & Cr-Mo

Art.	€	Dr.	Length	Teeth	Weight
0494/1/4	€ 21,00	1/4"	165 mm	72	0,13 kg
0494/3/8	€ 24,00	3/8"	215 mm	72	0,27 kg
0494/1/2	€ 28,90	1/2"	276 mm	72	0,52 kg

CN450Nx

ERGONOMIC RATCHET HANDLE



72 denti-teeth Cr-V & Cr-Mo

Art.	€	Dr.	Length	Teeth	Weight
CN450N1/4A	€ 20,90	1/4"	150 mm	72	125 g
CN450N3/8A	€ 24,20	3/8"	205 mm	72	280 g
CN450N1/2A	€ 25,00	1/2"	250 mm	72	540 g

0439-

ERGONOMIC RATCHET HANDLE

WITH 72 TEETH, 1/2" DR., WITH HANGER



72 denti-teeth Cr-V & Cr-Mo

Art.	€	Dr.	Length	Teeth
0439/1/4	€ 14,30	1/4"	155 mm	72
0439/3/8	€ 20,20	3/8"	200 mm	72
0439/1/2	€ 24,20	1/2"	260 mm	72

0440-

ERGONOMIC RATCHET HANDLE

SMALL HEAD WITH 72 TEETH, 1/2" DR., WITH HANGER



Art.	€	Dr.	Length	Teeth
0440/1/4	€ 15,20	1/4"	155 mm	72
0440/3/8	€ 19,40	3/8"	200 mm	72
0440/1/2	€ 23,30	1/2"	240 mm	72

0173

€ 3,83

1/4" DR. SPINNER HANDLE

MADE TO BEING USED ALSO AS AN EXTENSION



Length	6 / 12 mm
Dr.	2 - 3 - 4 - 5 - 6 - 8 - 10

0019-

1 1/4", 3/8", 1/2" DRIVE QUICK-RELEASE RATCHETS



Art.	€	Length	Dr.	Teeth
0019/1/4	€ 12,60	154 mm	1/4"	24
0019/3/8	€ 18,10	215 mm	3/8"	24
0019/1/2	€ 23,00	275 mm	1/2"	24

0308

€ 28,80

RATCHET HANDLE



0228

€ 8,90

RATCHET HANDLE



BN4E5Nx

STANDARD 6 POINT HAND SOCKET



Cr-V Chromed DIN 3124 1/4"

Art.	€	Size	D1	D2	Length	Weight
BN4E5N004A	€ 1,20	4 mm	6,8 mm	12 mm	25 mm	10 g
BN4E5N0045A	€ 1,20	4,5 mm	7,2 mm	12 mm	25 mm	10 g
BN4E5N005A	€ 1,20	5 mm	7,8 mm	12 mm	25 mm	11 g
BN4E5N0055A	€ 1,20	5,5 mm	8,4 mm	12 mm	25 mm	11 g
BN4E5N006A	€ 1,20	6 mm	9,3 mm	12 mm	25 mm	11 g
BN4E5N007A	€ 1,20	7 mm	10,8 mm	12 mm	25 mm	11 g
BN4E5N008A	€ 1,38	8 mm	12 mm	11 mm	25 mm	11 g
BN4E5N009A	€ 1,38	9 mm	13 mm	12 mm	25 mm	15 g
BN4E5N010A	€ 1,38	10 mm	14,6 mm	12 mm	25 mm	14 g
BN4E5N011A	€ 1,55	11 mm	16 mm	12,5 mm	25 mm	20 g
BN4E5N012A	€ 1,55	12 mm	17 mm	13,5 mm	25 mm	22 g
BN4E5N013A	€ 1,71	13 mm	18 mm	13,5 mm	25 mm	24 g
BN4E5N014A	€ 1,89	14 mm	19 mm	14,5 mm	25 mm	30 g

BN4P5Nx

STANDARD 12 POINT HAND SOCKET



Cr-V Chromed DIN 3124 1/4"

Art.	€	Size	D1	D2	Length	Weight
BN4P5N004A	€ 1,13	4 mm	6,8 mm	12 mm	25 mm	10 g
BN4P5N005A	€ 1,13	5 mm	7,8 mm	12 mm	25 mm	11 g
BN4P5N0055A	€ 1,13	5,5 mm	8,4 mm	12 mm	25 mm	11 g
BN4P5N006A	€ 1,13	6 mm	9,3 mm	12 mm	25 mm	11 g
BN4P5N007A	€ 1,13	7 mm	10,8 mm	12 mm	25 mm	11 g
BN4P5N008A	€ 1,29	8 mm	12 mm	11 mm	25 mm	11 g
BN4P5N009A	€ 1,29	9 mm	13 mm	12 mm	25 mm	15 g
BN4P5N010A	€ 1,29	10 mm	14,6 mm	12 mm	25 mm	14 g
BN4P5N011A	€ 1,46	11 mm	16 mm	12,5 mm	25 mm	20 g
BN4P5N012A	€ 1,46	12 mm	17 mm	13,5 mm	25 mm	22 g
BN4P5N013A	€ 1,64	13 mm	18 mm	13,5 mm	25 mm	24 g
BN4P5N014A	€ 1,71	14 mm	19 mm	14,5 mm	25 mm	30 g

BN4E5Lx

DEEP 6 POINT HAND SOCKET



Cr-V Chromed DIN 3124 1/4"

Art.	€	Size	D1	D2	Length	Weight
BN4E5L004A	€ 2,84	4 mm	6,8 mm	12 mm	50 mm	20 g
BN4E5L0045A	€ 2,84	4,5 mm	7,2 mm	12 mm	50 mm	21 g
BN4E5L005A	€ 2,84	5 mm	7,8 mm	12 mm	50 mm	21 g
BN4E5L0055A	€ 2,84	5,5 mm	8,4 mm	12 mm	50 mm	21 g
BN4E5L006A	€ 2,84	6 mm	9,3 mm	12 mm	50 mm	23 g
BN4E5L007A	€ 2,84	7 mm	10,8 mm	12 mm	50 mm	23 g
BN4E5L008A	€ 2,84	8 mm	12 mm	11 mm	50 mm	24 g
BN4E5L009A	€ 2,84	9 mm	13 mm	12 mm	50 mm	29 g
BN4E5L010A	€ 2,84	10 mm	14,6 mm	12 mm	50 mm	38 g
BN4E5L011A	€ 3,09	11 mm	16 mm	13 mm	50 mm	44 g
BN4E5L012A	€ 3,09	12 mm	17 mm	13 mm	50 mm	53 g
BN4E5L013A	€ 3,26	13 mm	18 mm	13 mm	50 mm	51 g
BN4E5L014A	€ 3,26	14 mm	19 mm	14,5 mm	50 mm	68 g

BN415Nx

HEX BIT SOCKET

LENGTH 37 mm



Cr-V Chromed 1/4"

Art.	€	Size	D2	Weight
BN415N003A	€ 2,15	3 mm	12 mm	13 g
BN415N004A	€ 2,15	4 mm	12 mm	15 g
BN415N005A	€ 2,15	5 mm	12 mm	15 g
BN415N006A	€ 2,15	6 mm	12 mm	15 g
BN415N008A	€ 2,15	8 mm	12 mm	17 g



BN425Nx

TORX BIT SOCKET

LENGTH 37 mm



Cr-V Chromed 1/4"

Art.	€	Size	D2	Weight
BN425N008A	€ 2,15	T8	12 mm	12 g
BN425N009A	€ 2,15	T9	12 mm	12 g
BN425N010A	€ 2,15	T10	12 mm	13 g
BN425N015A	€ 2,15	T15	12 mm	14 g
BN425N020A	€ 2,15	T20	12 mm	14 g
BN425N025A	€ 2,15	T20	12 mm	14 g
BN425N027A	€ 2,15	T27	12 mm	14 g
BN425N030A	€ 2,15	T30	12 mm	15 g
BN425N040A	€ 2,15	T40	12 mm	16 g

BN445Nx

XZN BIT SOCKET

LENGTH 37 mm



Cr-V Chromed 1/4"

Art.	€	Size	D2	Weight
BN445N004A	€ 7,20	M 4	15 mm	12 g
BN445N005A	€ 7,20	M 5	15 mm	12 g
BN445N006A	€ 7,20	M 6	15 mm	13 g
BN445N008A	€ 7,20	M 8	15 mm	14 g
BN445N009A	€ 7,20	M 9	15 mm	14 g
BN445N010A	€ 7,20	M 10	15 mm	15 g

RN4054NA

€ 2,57

ADAPTER

MICRO CHROMIUM PLATED WITH 1/4" FEMALE AND 3/8" MALE DRIVES

Cr-V Chromed

Female and male Dr.	1/4" 3/8"
Length	26 mm
Weight	20 g



JN405NA

€ 4,65

UNIVERSAL JOINT

Cr-V Chromed 1/4"

Length	38 mm
Weight	29 g



PN405Nx

EXTENSION BAR



Cr-V Chromed 1/4"

Art.	€	Length	Weight
PN405N050A	€ 2,57	50 mm	24 g
PN405N075A	€ 2,75	75 mm	37 g
PN405N150A	€ 4,13	150 mm	67 g

EN405Nx

WOBBLE EXTENSION BAR



Cr-V Chromed 1/4"

Art.	€	Length	Weight
EN405N050A	€ 3,42	50 mm	23 g
EN405N075A	€ 3,90	75 mm	35 g
EN405N150A	€ 4,28	150 mm	68 g



LN400N1/4A

€ 3,90

SLIDING T BAR



Cr-V Chromed 1/4"

Length	115 mm
Weight	41 g

BN4E4Nx

STANDARD 6 POINT HAND SOCKET



Cr-V Chromed DIN 3124 3/8"

Art.	€	Size	D1	D2	Length	Weight
BN4E4N006A	€ 2,06	6 mm	9,3 mm	17 mm	28 mm	25 g
BN4E4N007A	€ 2,06	7 mm	10,6 mm	17 mm	28 mm	24 g
BN4E4N008A	€ 2,06	8 mm	11,8 mm	17 mm	28 mm	25 g
BN4E4N009A	€ 2,06	9 mm	13,2 mm	17 mm	28 mm	25 g
BN4E4N010A	€ 2,06	10 mm	14,5 mm	17 mm	28 mm	27 g
BN4E4N011A	€ 2,06	10 mm	15,7 mm	17 mm	28 mm	28 g
BN4E4N012A	€ 2,06	12 mm	17 mm	16,4 mm	28 mm	28 g
BN4E4N013A	€ 2,06	13 mm	18 mm	17 mm	28 mm	31 g
BN4E4N014A	€ 2,57	14 mm	20 mm	17 mm	28 mm	34 g
BN4E4N015A	€ 2,57	15 mm	20,9 mm	18 mm	28 mm	47 g
BN4E4N016A	€ 2,57	16 mm	22 mm	18 mm	28 mm	45 g
BN4E4N017A	€ 2,57	17 mm	24 mm	18 mm	30 mm	53 g
BN4E4N018A	€ 3,09	18 mm	26 mm	18 mm	30 mm	58 g
BN4E4N019A	€ 3,26	19 mm	26 mm	20 mm	30 mm	64 g
BN4E4N020A	€ 3,83	20 mm	27,1 mm	20 mm	30 mm	73 g
BN4E4N021A	€ 3,83	21 mm	28 mm	20 mm	30 mm	82 g
BN4E4N022A	€ 4,50	22 mm	30 mm	20 mm	32 mm	87 g

BN4E4Lx

DEEP 6 POINT HAND SOCKET



Cr-V Chromed DIN 3124 3/8"

Art.	€	Size	D1	D2	Length	Weight
BN4E4L006A	€ 4,50	6 mm	9,3 mm	17 mm	63 mm	50 g
BN4E4L007A	€ 4,50	7 mm	10,6 mm	17 mm	62 mm	52 g
BN4E4L008A	€ 4,50	8 mm	11,8 mm	17 mm	63 mm	52 g
BN4E4L009A	€ 4,50	9 mm	13,2 mm	17 mm	63 mm	56 g
BN4E4L010A	€ 4,50	10 mm	14,5 mm	17 mm	63 mm	60 g
BN4E4L011A	€ 4,50	11 mm	15,7 mm	17 mm	63 mm	68 g
BN4E4L012A	€ 4,50	12 mm	17 mm	16,4 mm	63 mm	68 g
BN4E4L013A	€ 4,50	13 mm	18 mm	17 mm	63 mm	64 g
BN4E4L014A	€ 5,10	14 mm	19,6 mm	17 mm	63 mm	72 g
BN4E4L015A	€ 5,10	15 mm	20,9 mm	18 mm	63 mm	88 g
BN4E4L016A	€ 5,10	16 mm	22 mm	18 mm	63 mm	88 g
BN4E4L017A	€ 5,10	17 mm	23,4 mm	18 mm	63 mm	112 g
BN4E4L018A	€ 5,90	18 mm	24,6 mm	20 mm	63 mm	126 g
BN4E4L019A	€ 5,90	19 mm	26 mm	20 mm	63 mm	124 g
BN4E4L020A	€ 5,90	20 mm	27,1 mm	20 mm	63 mm	125 g
BN4E4L021A	€ 6,90	21 mm	28 mm	20 mm	63 mm	126 g
BN4E4L022A	€ 6,90	22 mm	30 mm	20 mm	63 mm	128 g

BN4P4Nx

STANDARD 12 POINT HAND SOCKET



Cr-V Chromed DIN 3125 3/8"

Art.	€	Size	D1	D2	Length	Weight
BN4P4N006A	€ 1,89	6 mm	9,3 mm	17 mm	28 mm	25 g
BN4P4N007A	€ 1,89	7 mm	10,6 mm	17 mm	28 mm	24 g
BN4P4N008A	€ 1,89	8 mm	11,8 mm	17 mm	28 mm	25 g
BN4P4N009A	€ 1,89	9 mm	13,2 mm	17 mm	28 mm	25 g
BN4P4N010A	€ 1,89	10 mm	14,5 mm	17 mm	28 mm	27 g
BN4P4N011A	€ 1,89	11 mm	15,7 mm	17 mm	28 mm	28 g
BN4P4N012A	€ 1,89	12 mm	17 mm	16,4 mm	28 mm	28 g
BN4P4N013A	€ 1,89	13 mm	18 mm	17 mm	28 mm	31 g
BN4P4N014A	€ 2,40	14 mm	20 mm	17 mm	28 mm	34 g
BN4P4N015A	€ 2,40	15 mm	20,9 mm	18 mm	28 mm	47 g
BN4P4N016A	€ 2,40	16 mm	22 mm	18 mm	28 mm	45 g
BN4P4N017A	€ 2,40	17 mm	24 mm	18 mm	30 mm	53 g
BN4P4N018A	€ 2,91	18 mm	26 mm	18 mm	30 mm	58 g
BN4P4N019A	€ 3,09	19 mm	26 mm	20 mm	30 mm	64 g
BN4P4N020A	€ 3,51	20 mm	28 mm	20 mm	30 mm	73 g
BN4P4N021A	€ 3,51	21 mm	28 mm	20 mm	30 mm	82 g
BN4P4N022A	€ 4,20	22 mm	30 mm	20 mm	32 mm	87 g

BN414Nx

HEX BIT SOCKET

LENGTH 48 mm



Cr-V Chromed 3/8"

Art.	€	Size	D2	Weight
BN414N003A	€ 4,88	3 mm	18 mm	28 g
BN414N004A	€ 4,88	4 mm	18 mm	30 g
BN414N005A	€ 4,88	5 mm	18 mm	34 g
BN414N006A	€ 4,88	6 mm	18 mm	38 g
BN414N007A	€ 4,88	7 mm	18 mm	38 g
BN414N008A	€ 4,88	8 mm	18 mm	40 g
BN414N009A	€ 4,88	9 mm	20 mm	40 g
BN414N010A	€ 4,88	10 mm	20 mm	40 g
BN414N012A	€ 5,00	12 mm	20 mm	42 g

BN414Lx

LONG HEX BIT SOCKET

LENGTH 95 mm



Cr-V Chromed 3/8"

Art.	€	Size	D2	Weight
BN414L003A	€ 7,10	3 mm	18 mm	39 g
BN414L004A	€ 7,10	4 mm	18 mm	41 g
BN414L005A	€ 7,10	5 mm	18 mm	45 g
BN414L006A	€ 7,10	6 mm	18 mm	49 g
BN414L007A	€ 7,20	7 mm	18 mm	56 g
BN414L008A	€ 7,20	8 mm	18 mm	56 g
BN414L009A	€ 7,20	9 mm	20 mm	56 g
BN414L010A	€ 7,20	10 mm	20 mm	66 g
BN414L012A	€ 8,20	12 mm	20 mm	79 g

BN424Nx

TORX BIT SOCKET

LENGTH 48 mm



Cr-V Chromed 3/8"

Art.	€	Size	D2	Weight
BN424N010A	€ 5,20	T10	18 mm	26 g
BN424N015A	€ 5,20	T15	18 mm	28 g
BN424N020A	€ 5,20	T20	18 mm	30 g
BN424N025A	€ 5,20	T25	18 mm	34 g
BN424N027A	€ 5,20	T27	18 mm	38 g
BN424N030A	€ 5,20	T30	18 mm	38 g
BN424N040A	€ 5,20	T40	18 mm	40 g
BN424N045A	€ 5,20	T45	18 mm	40 g
BN424N050A	€ 5,90	T50	20 mm	40 g
BN424N055A	€ 6,90	T55	20 mm	45 g

BN424Lx

LONG TORX BIT SOCKET

LENGTH 95 mm



Cr-V Chromed 3/8"

Art.	€	Size	D2	Weight
BN424L015A	€ 8,60	T15	18 mm	39 g
BN424L020A	€ 8,60	T20	18 mm	41 g
BN424L025A	€ 8,60	T25	18 mm	45 g
BN424L027A	€ 8,60	T27	18 mm	49 g
BN424L030A	€ 8,60	T30	18 mm	49 g
BN424L040A	€ 8,60	T40	18 mm	51 g
BN424L045A	€ 11,50	T45	18 mm	51 g

BN434Nx

RIBE BIT SOCKET

LENGTH 50 mm



Cr-V Chromed 3/8"

Art.	€	Size	D2	Weight
BN434N004A	€ 11,00	M 4	18 mm	59 g
BN434N005A	€ 11,20	M 5	18 mm	60 g
BN434N006A	€ 11,40	M 6	18 mm	62 g
BN434N007A	€ 11,60	M 7	18 mm	63 g
BN434N008A	€ 11,80	M 8	18 mm	79 g
BN434N009A	€ 12,30	M 9	18 mm	80 g
BN434N010A	€ 13,40	M 10	20 mm	82 g

BN434Lx

LONG RIBE BIT SOCKET

LENGTH 95 mm

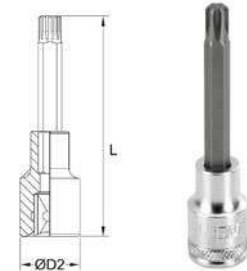

Cr-V Chromed 3/8"

Art.	€	Size	D2	Weight
BN434L004A	€ 11,80	M 4	18 mm	70 g
BN434L005A	€ 12,00	M 5	18 mm	71 g
BN434L006A	€ 12,20	M 6	18 mm	73 g
BN434L007A	€ 12,20	M 7	18 mm	74 g
BN434L008A	€ 12,90	M 8	18 mm	90 g
BN434L009A	€ 12,90	M 9	18 mm	91 g
BN434L010A	€ 15,80	M 10	20 mm	93 g

BN444Nx

XZN BIT SOCKET

LENGTH 48 mm



Cr-V Chromed 3/8"

Art.	€	Size	D2	Weight
BN444N004A	€ 8,60	M 4	18 mm	28 g
BN444N005A	€ 8,60	M 5	18 mm	30 g
BN444N006A	€ 8,60	M 6	18 mm	34 g
BN444N008A	€ 8,60	M 8	18 mm	38 g
BN444N009A	€ 8,60	M 9	20 mm	38 g
BN444N010A	€ 8,60	M 10	20 mm	40 g
BN444N012A	€ 9,10	M 12	20 mm	40 g
BN444N014A	€ 9,70	M 14	20 mm	40 g

BN444Lx

LONG XZN BIT SOCKET

LENGTH 95 mm



Cr-V Chromed 3/8"

Art.	€	Size	D2	Weight
BN444L004A	€ 9,40	M 4	18 mm	28 g
BN444L005A	€ 9,40	M 5	18 mm	30 g
BN444L006A	€ 9,40	M 6	18 mm	34 g
BN444L008A	€ 9,40	M 8	18 mm	38 g
BN444L009A	€ 9,40	M 9	20 mm	38 g
BN444L010A	€ 9,70	M 10	20 mm	40 g
BN444L012A	€ 10,40	M 12	20 mm	40 g
BN444L014A	€ 11,10	M 14	20 mm	40 g

BN4C4Lx

SPARK PLUG SOCKET



Cr-V Chromed 3/8"

Art.	€	Size	Length	Weight
BN4C4L016A	€ 4,28	16 mm	63 mm	69,4 g
BN4C4L018A	€ 6,00	18 mm	63 mm	98,2 g
BN4C4L021A	€ 6,50	21 mm	65 mm	99 g

LN400N3/8A

€ 7,50

SLIDING T BAR



Cr-V Chromed 3/8"

Length	200 mm
Weight	182 g

RN4045NA

€ 2,57

ADAPTER

MICRO CHROMIUM PLATED WITH 3/8" FEMALE AND 1/4" MALE DRIVES

Cr-V Chromed

Female and male Dr.	3/8" 1/4"
Length	27 mm
Weight	31,5 g



RN4043NA

€ 3,00

ADAPTER

WITH 3/8" FEMALE AND 1/2" MALE DRIVES

Cr-V Chromed

Female and male Dr.	3/8" 1/2"
Length	35 mm
Weight	47 g



JN404NA

€ 5,90

UNIVERSAL JOINT

Cr-V Chromed 3/8"

Length	54 mm
Weight	80 g



PN404Nx

EXTENSION BAR

Cr-V Chromed 3/8"

Art.	€	Length	Weight
PN404N050A	€ 2,91	50 mm	50 g
PN404N075A	€ 3,98	75 mm	75 g
PN404N150A	€ 4,80	150 mm	150 g



EN404Nx

WOBBLE EXTENSION BAR

Cr-V Chromed 3/8"

Art.	€	Length	Weight
EN404N038A	€ 3,42	38 mm	39 g
EN404N075A	€ 4,28	75 mm	75 g
EN404N150A	€ 5,20	150 mm	150 g
EN404N250A	€ 8,40	250 mm	240 g



BN4E3Nx

STANDARD 6 POINT HAND SOCKET



Cr-V Chromed DIN 3124 1/2"

Art.	€	Size	D1	D2	Length	Weight
BN4E3N008A	€ 2,57	8 mm	12,2 mm	22 mm	38 mm	61 g
BN4E3N009A	€ 2,57	9 mm	13,5 mm	22 mm	38 mm	59 g
BN4E3N010A	€ 2,57	10 mm	15 mm	22 mm	38 mm	60 g
BN4E3N011A	€ 2,57	11 mm	16,3 mm	22 mm	38 mm	60 g
BN4E3N012A	€ 2,57	12 mm	17,6 mm	22 mm	38 mm	61 g
BN4E3N013A	€ 2,57	13 mm	18,8 mm	22 mm	38 mm	63 g
BN4E3N014A	€ 2,57	14 mm	20,4 mm	22 mm	38 mm	63 g
BN4E3N015A	€ 2,66	15 mm	21 mm	22 mm	38 mm	66 g
BN4E3N016A	€ 2,88	16 mm	22 mm	20,5 mm	38 mm	64 g
BN4E3N017A	€ 3,09	17 mm	24 mm	22 mm	38 mm	68 g
BN4E3N018A	€ 3,35	18 mm	25,4 mm	22 mm	38 mm	75 g
BN4E3N019A	€ 3,35	19 mm	26 mm	22 mm	38 mm	86 g
BN4E3N020A	€ 3,57	20 mm	28 mm	22 mm	38 mm	95 g
BN4E3N021A	€ 3,74	21 mm	28 mm	22 mm	38 mm	97 g
BN4E3N022A	€ 4,20	22 mm	30 mm	26 mm	38 mm	105 g
BN4E3N023A	€ 4,28	23 mm	31,6 mm	26 mm	38 mm	118 g
BN4E3N024A	€ 4,28	24 mm	32 mm	26 mm	38 mm	138 g
BN4E3N025A	€ 4,73	25 mm	34 mm	26 mm	42 mm	141 g
BN4E3N026A	€ 4,80	26 mm	35,4 mm	28 mm	42 mm	158 g
BN4E3N027A	€ 4,80	27 mm	36 mm	28 mm	42 mm	161 g
BN4E3N028A	€ 5,10	28 mm	38 mm	28 mm	42 mm	162 g
BN4E3N029A	€ 5,30	29 mm	38 mm	28 mm	43 mm	199 g
BN4E3N030A	€ 5,30	30 mm	40 mm	28 mm	43 mm	214 g
BN4E3N032A	€ 5,30	32 mm	42 mm	28 mm	44 mm	236 g

BN4P3Nx

STANDARD 12 POINT HAND SOCKET



Cr-V Chromed DIN 3124 1/2"

Art.	€	Size	D1	D2	Length	Weight
BN4P3N008A	€ 2,40	8 mm	12,2 mm	22 mm	38 mm	61 g
BN4P3N009A	€ 2,40	9 mm	13,5 mm	22 mm	38 mm	59 g
BN4P3N010A	€ 2,40	10 mm	15 mm	22 mm	38 mm	60 g
BN4P3N011A	€ 2,40	11 mm	16,3 mm	22 mm	38 mm	60 g
BN4P3N012A	€ 2,40	12 mm	17,6 mm	22 mm	38 mm	61 g
BN4P3N013A	€ 2,40	13 mm	18,8 mm	22 mm	38 mm	63 g
BN4P3N014A	€ 2,40	14 mm	20,4 mm	22 mm	38 mm	63 g
BN4P3N015A	€ 2,49	15 mm	21 mm	22 mm	38 mm	66 g
BN4P3N016A	€ 2,66	16 mm	22 mm	20,5 mm	38 mm	64 g
BN4P3N017A	€ 2,91	17 mm	24 mm	22 mm	38 mm	68 g
BN4P3N018A	€ 3,17	18 mm	25,4 mm	22 mm	38 mm	75 g
BN4P3N019A	€ 3,17	19 mm	26 mm	22 mm	38 mm	86 g
BN4P3N020A	€ 3,35	20 mm	28 mm	22 mm	38 mm	95 g
BN4P3N021A	€ 3,51	21 mm	28 mm	22 mm	38 mm	97 g
BN4P3N022A	€ 3,98	22 mm	30 mm	26 mm	38 mm	105 g
BN4P3N023A	€ 4,05	23 mm	31,6 mm	26 mm	38 mm	118 g
BN4P3N024A	€ 4,05	24 mm	32 mm	26 mm	38 mm	138 g
BN4P3N025A	€ 4,73	25 mm	34 mm	26 mm	42 mm	141 g
BN4P3N026A	€ 4,80	26 mm	35,4 mm	28 mm	42 mm	158 g
BN4P3N027A	€ 4,80	27 mm	36 mm	28 mm	42 mm	161 g
BN4P3N028A	€ 5,10	28 mm	38 mm	28 mm	43 mm	162 g
BN4P3N029A	€ 5,30	29 mm	38 mm	28 mm	43 mm	199 g
BN4P3N030A	€ 5,30	30 mm	40 mm	28 mm	43 mm	214 g
BN4P3N032A	€ 5,30	32 mm	42 mm	28 mm	44 mm	236 g

BN4E3Lx

DEEP 6 POINT HAND SOCKET



Cr-V Chromed DIN 3124 1/2"

Art.	€	Size	D1	D2	Length	Weight
BN4E3L010A	€ 5,60	10 mm	15 mm	22 mm	77 mm	116 g
BN4E3L011A	€ 5,60	11 mm	16,3 mm	22 mm	77 mm	118 g
BN4E3L012A	€ 5,60	12 mm	17,6 mm	22 mm	77 mm	125 g
BN4E3L013A	€ 5,60	13 mm	18,8 mm	22 mm	77 mm	124 g
BN4E3L014A	€ 5,90	14 mm	20,4 mm	22 mm	77 mm	127 g
BN4E3L015A	€ 5,90	15 mm	21 mm	22 mm	77 mm	140 g
BN4E3L016A	€ 5,90	16 mm	22 mm	20,5 mm	77 mm	139 g
BN4E3L017A	€ 6,00	17 mm	24 mm	22 mm	77 mm	132 g
BN4E3L018A	€ 6,50	18 mm	25,4 mm	22 mm	77 mm	136 g
BN4E3L019A	€ 6,50	19 mm	26 mm	22 mm	77 mm	151 g
BN4E3L020A	€ 6,80	20 mm	28 mm	22 mm	77 mm	194 g
BN4E3L021A	€ 7,10	21 mm	28 mm	22 mm	77 mm	163 g
BN4E3L022A	€ 7,10	22 mm	30 mm	26 mm	77 mm	166 g
BN4E3L023A	€ 8,50	23 mm	31,6 mm	26 mm	77 mm	208 g
BN4E3L024A	€ 8,90	24 mm	32 mm	26 mm	77 mm	212 g
BN4E3L027A	€ 12,50	27 mm	36 mm	28 mm	77 mm	312 g
BN4E3L030A	€ 13,50	30 mm	40 mm	28 mm	77 mm	307 g
BN4E3L032A	€ 13,50	32 mm	42 mm	28 mm	77 mm	334 g

BN4P3Lx

DEEP 12 POINT HAND SOCKET



Cr-V Chromed DIN 3124 1/2"

Art.	€	Size	D1	D2	Length	Weight
BN4P3L010A	€ 5,30	10 mm	15 mm	22 mm	77 mm	116 g
BN4P3L011A	€ 5,30	11 mm	16,3 mm	22 mm	77 mm	118 g
BN4P3L012A	€ 5,30	12 mm	17,6 mm	22 mm	77 mm	125 g
BN4P3L013A	€ 5,30	13 mm	18,8 mm	22 mm	77 mm	124 g
BN4P3L014A	€ 5,50	14 mm	20,4 mm	22 mm	77 mm	127 g
BN4P3L015A	€ 5,50	15 mm	21 mm	22 mm	77 mm	140 g
BN4P3L016A	€ 5,50	16 mm	22 mm	20,5 mm	77 mm	139 g
BN4P3L017A	€ 5,70	17 mm	24 mm	22 mm	77 mm	132 g
BN4P3L018A	€ 6,10	18 mm	25,4 mm	22 mm	77 mm	136 g
BN4P3L019A	€ 6,10	19 mm	26 mm	22 mm	77 mm	151 g
BN4P3L020A	€ 6,40	20 mm	28 mm	22 mm	77 mm	194 g
BN4P3L021A	€ 6,70	21 mm	28 mm	22 mm	77 mm	163 g
BN4P3L022A	€ 7,10	22 mm	30 mm	26 mm	77 mm	166 g
BN4P3L023A	€ 8,50	23 mm	31,6 mm	26 mm	77 mm	208 g
BN4P3L024A	€ 8,50	24 mm	32 mm	26 mm	77 mm	212 g
BN4P3L027A	€ 12,50	27 mm	36 mm	28 mm	77 mm	312 g
BN4P3L030A	€ 13,50	30 mm	40 mm	28 mm	77 mm	307 g
BN4P3L032A	€ 13,50	32 mm	42 mm	28 mm	77 mm	334 g

BN413Nx

HEX BIT SOCKET

LENGTH 55 mm



Cr-V Chromed 1/2"



Art.	€	Size	D2	Weight
BN413N004A	€ 4,88	4 mm	22 mm	68 g
BN413N005A	€ 4,88	5 mm	22 mm	70 g
BN413N006A	€ 4,88	6 mm	22 mm	72 g
BN413N007A	€ 5,40	7 mm	22 mm	75 g
BN413N008A	€ 5,40	8 mm	22 mm	75 g
BN413N010A	€ 5,40	10 mm	22 mm	85 g
BN413N012A	€ 5,40	12 mm	22 mm	117 g
BN413N014A	€ 6,40	14 mm	24 mm	120 g
BN413N017A	€ 6,90	17 mm	26 mm	153 g
BN413N019A	€ 6,90	19 mm	28 mm	185 g

BN413Lx

LONG HEX BIT SOCKET

LENGTH 100 mm



Cr-V Chromed 1/2"

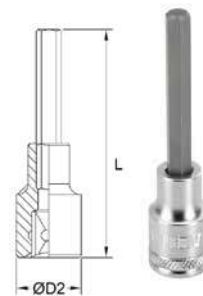

Art.	€	Size	D2	Weight
BN413L004A	€ 6,40	4 mm	22 mm	90 g
BN413L005A	€ 6,40	5 mm	22 mm	90 g
BN413L006A	€ 6,40	6 mm	22 mm	90 g
BN413L007A	€ 6,40	7 mm	22 mm	90 g
BN413L008A	€ 6,40	8 mm	22 mm	93 g
BN413L010A	€ 6,40	10 mm	22 mm	107 g
BN413L012A	€ 6,50	12 mm	22 mm	145 g
BN413L014A	€ 6,50	14 mm	24 mm	145 g
BN413L017A	€ 9,40	17 mm	26 mm	200 g
BN413L019A	€ 10,10	19 mm	28 mm	245 g

BN423Nx

TORX BIT SOCKET

LENGTH 55 mm



Cr-V Chromed 1/2"



Art.	€	Size	D2	Weight
BN423N020A	€ 6,10	T20	22 mm	70 g
BN423N025A	€ 6,10	T25	22 mm	70 g
BN423N027A	€ 6,10	T27	22 mm	70 g
BN423N030A	€ 6,10	T30	22 mm	73 g
BN423N040A	€ 6,60	T40	22 mm	73 g
BN423N045A	€ 6,60	T45	22 mm	78 g
BN423N050A	€ 6,60	T50	22 mm	80 g
BN423N055A	€ 7,40	T55	22 mm	83 g
BN423N060A	€ 7,80	T60	22 mm	113 g
BN423N070A	€ 9,60	T70	22 mm	115 g

BN423Lx

LONG TORX BIT SOCKET

LENGTH 100 mm



Cr-V Chromed 1/2"

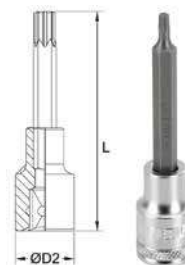

Art.	€	Size	D2	Weight
BN423L020A	€ 6,90	T20	22 mm	90 g
BN423L025A	€ 6,90	T25	22 mm	90 g
BN423L027A	€ 6,90	T27	22 mm	90 g
BN423L030A	€ 6,90	T30	22 mm	90 g
BN423L040A	€ 7,20	T40	22 mm	93 g
BN423L045A	€ 7,20	T45	22 mm	93 g
BN423L050A	€ 7,20	T50	22 mm	100 g
BN423L055A	€ 8,60	T55	22 mm	103 g
BN423L060A	€ 8,60	T60	22 mm	133 g
BN423L070A	€ 11,60	T70	22 mm	135 g

BN433Nx

RIBE BIT SOCKET

LENGTH 55 mm



Cr-V Chromed 1/2"



Art.	€	Size	D2	Weight
BN433N008A	€ 6,60	M 8	22 mm	78 g
BN433N009A	€ 6,60	M 9	22 mm	80 g
BN433N010A	€ 6,60	M 10	22 mm	86 g
BN433N012A	€ 7,20	M 12	22 mm	112 g
BN433N013A	€ 7,70	M 13	24 mm	142 g
BN433N014A	€ 7,70	M 14	24 mm	144 g

BN433Lx

LONG RIBE BIT SOCKET

LENGTH 100 mm



Cr-V Chromed 1/2"

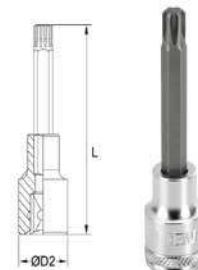

Art.	€	Size	D2	Weight
BN433L008A	€ 8,20	M 8	24 mm	98 g
BN433L009A	€ 8,20	M 9	24 mm	100 g
BN433L010A	€ 8,20	M 10	24 mm	106 g
BN433L012A	€ 8,90	M 12	24 mm	132 g
BN433L013A	€ 8,90	M 13	24 mm	162 g
BN433L014A	€ 10,40	M 14	24 mm	164 g

BN443Nx

XZN BIT SOCKET

LENGTH 55 mm

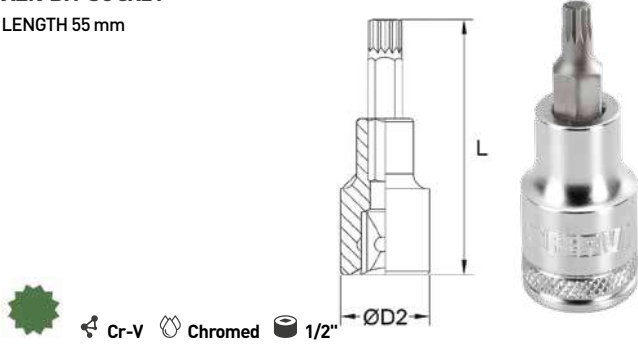

Cr-V Chromed 1/2"

Art.	€	Size	D2	Weight
BN443N005A	€ 6,90	M 5	22 mm	50 g
BN443N006A	€ 6,90	M 6	22 mm	50 g
BN443N008A	€ 6,90	M 8	22 mm	50 g
BN443N009A	€ 6,90	M 9	22 mm	54 g
BN443N010A	€ 6,90	M 10	22 mm	56 g
BN443N012A	€ 7,80	M 12	22 mm	60 g
BN443N014A	€ 7,80	M 14	24 mm	64 g
BN443N016A	€ 7,90	M 16	24 mm	65 g

BN443Lx

LONG XZN BIT SOCKET

LENGTH 100 mm

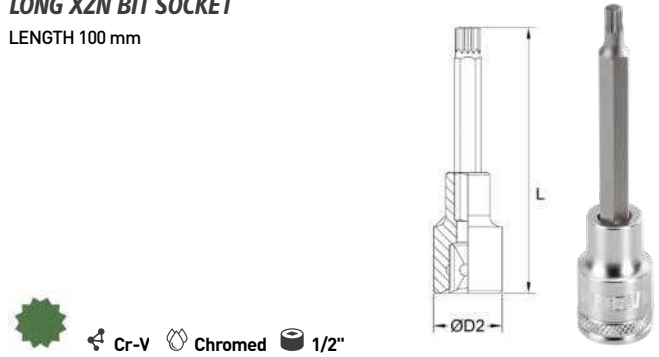

Cr-V Chromed 1/2"

Art.	€	Size	D2	Weight
BN443L005A	€ 7,90	M 5	22 mm	66 g
BN443L006A	€ 7,90	M 6	22 mm	67 g
BN443L008A	€ 7,90	M 8	22 mm	68 g
BN443L009A	€ 8,30	M 9	22 mm	71 g
BN443L010A	€ 8,30	M 10	22 mm	72 g
BN443L012A	€ 8,70	M 12	22 mm	73 g
BN443L014A	€ 9,20	M 14	24 mm	73 g
BN443L016A	€ 9,50	M 16	24 mm	73 g

BN4C3Lx

SPARK PLUG SOCKET



Cr-V Chromed 1/2"

Art.	€	Size	Length	Weight
BN4C3L016A	€ 3,98	16 mm	65 mm	115 g
BN4C3L018A	€ 4,65	18 mm	65 mm	140 g
BN4C3L021A	€ 5,60	21 mm	65 mm	165 g

PN403Nx

EXTENSION BAR



Cr-V Chromed 1/2"

Art.	€	Length	Weight
PN403N050A	€ 4,13	50 mm	98 g
PN403N075A	€ 5,20	75 mm	138 g
PN403N150A	€ 7,30	150 mm	230 g
PN403N250A	€ 9,00	250 mm	433 g

EN403Nx

WOBBLE EXTENSION BAR



Cr-V Chromed 1/2"

Art.	€	Dr.	Length	Weight
EN403N050A	€ 4,80	1/2"	50 mm	94 g
EN403N075A	€ 5,20	1/2"	75 mm	100 g
EN403N125A	€ 7,30	1/2"	125 mm	198 g
EN403N250A	€ 12,50	1/2"	250 mm	357 g
EN403N500A	€ 20,90	1/2"	500 mm	420 g

LN400N1/2A

€ 10,10

SLIDING T BAR



Cr-V Chromed 1/2"

Length	300 mm
Weight	433 g

RN4034NA

€ 3,00

ADAPTER

WITH 1/2" FEMALE AND 3/8" MALE DRIVES

Cr-V Chromed

Female and male Dr.	1/2" 3/8"
Length	36 mm
Weight	61 g



RN4032NA

€ 6,90

ADAPTER

WITH 1/2" FEMALE AND 3/4" MALE DRIVES

Cr-V Chromed

Female and male Dr.	1/2" 3/4"
Length	46 mm
Weight	114 g



JN403NA

€ 8,50

UNIVERSAL JOINT

Cr-V Chromed 1/2"

Length	75 mm
Weight	163 g



BN4E2Nx

STANDARD 6 POINT HAND SOCKET



Cr-V Chromed DIN 3124 3/4"

Art.	€	Size	D1	D2	Length	Weight
BN4E2N019	€ 6,50	19 mm	30 mm	36 mm	50 mm	207 g
BN4E2N020	€ 6,50	20 mm	31 mm	36 mm	50 mm	209 g
BN4E2N021	€ 6,50	21 mm	32 mm	36 mm	50 mm	210 g
BN4E2N022	€ 6,50	22 mm	33 mm	36 mm	50 mm	209 g
BN4E2N023	€ 6,50	23 mm	34 mm	36 mm	50 mm	216 g
BN4E2N024	€ 6,50	24 mm	35 mm	36 mm	50 mm	219 g
BN4E2N025	€ 6,50	25 mm	36 mm	35 mm	52 mm	240 g
BN4E2N026	€ 6,50	26 mm	37 mm	36 mm	52 mm	243 g
BN4E2N027	€ 7,70	27 mm	38 mm	36 mm	52 mm	238 g
BN4E2N028	€ 7,70	28 mm	39 mm	38 mm	52 mm	233 g
BN4E2N029	€ 7,70	29 mm	40 mm	38 mm	52 mm	261 g
BN4E2N030	€ 7,70	30 mm	42 mm	38 mm	54 mm	295 g
BN4E2N032	€ 7,70	32 mm	43 mm	38 mm	56 mm	305 g
BN4E2N033	€ 8,20	33 mm	44 mm	38 mm	56 mm	317 g
BN4E2N034	€ 8,20	34 mm	46 mm	38 mm	56 mm	317 g
BN4E2N035	€ 8,40	35 mm	47 mm	42 mm	56 mm	400 g
BN4E2N036	€ 8,40	36 mm	48 mm	42 mm	58 mm	406 g
BN4E2N038	€ 10,10	38 mm	50 mm	42 mm	58 mm	434 g
BN4E2N041	€ 11,40	41 mm	52 mm	45 mm	60 mm	497 g
BN4E2N046	€ 12,60	46 mm	56 mm	45 mm	64 mm	581 g
BN4E2N050	€ 15,20	50 mm	62 mm	48 mm	68 mm	724 g
BN4E2N055	€ 18,50	55 mm	68 mm	48 mm	72 mm	889 g
BN4E2N060	€ 23,00	60 mm	74 mm	48 mm	76 mm	889 g

BN4P2Nx

STANDARD 12 POINT HAND SOCKET



Cr-V Chromed DIN 3124 3/4"

Art.	€	Size	D1	D2	Length	Weight
BN4P2N019	€ 6,00	19 mm	30 mm	36 mm	50 mm	207 g
BN4P2N020	€ 6,00	20 mm	31 mm	36 mm	50 mm	209 g
BN4P2N021	€ 6,00	21 mm	32 mm	36 mm	50 mm	210 g
BN4P2N022	€ 6,00	22 mm	33 mm	36 mm	50 mm	209 g
BN4P2N023	€ 6,00	23 mm	34 mm	36 mm	50 mm	216 g
BN4P2N024	€ 6,00	24 mm	35 mm	36 mm	50 mm	219 g
BN4P2N025	€ 6,00	25 mm	36 mm	35 mm	52 mm	240 g
BN4P2N026	€ 6,00	26 mm	37 mm	36 mm	52 mm	243 g
BN4P2N027	€ 7,30	27 mm	38 mm	36 mm	52 mm	238 g
BN4P2N028	€ 7,30	28 mm	39 mm	38 mm	52 mm	233 g
BN4P2N029	€ 7,30	29 mm	40 mm	38 mm	52 mm	261 g
BN4P2N030	€ 7,30	30 mm	42 mm	38 mm	54 mm	295 g
BN4P2N032	€ 7,30	32 mm	43 mm	38 mm	56 mm	305 g
BN4P2N033	€ 7,70	33 mm	44 mm	38 mm	56 mm	317 g
BN4P2N034	€ 8,20	34 mm	46 mm	38 mm	56 mm	317 g
BN4P2N035	€ 8,20	35 mm	47 mm	42 mm	56 mm	400 g
BN4P2N036	€ 8,20	36 mm	48 mm	42 mm	58 mm	406 g
BN4P2N038	€ 9,60	38 mm	50 mm	42 mm	58 mm	434 g
BN4P2N041	€ 10,80	41 mm	52 mm	45 mm	60 mm	497 g
BN4P2N046	€ 12,00	46 mm	56 mm	45 mm	64 mm	581 g
BN4P2N050	€ 14,40	50 mm	62 mm	48 mm	68 mm	724 g
BN4P2N055	€ 18,50	55 mm	68 mm	48 mm	72 mm	889 g
BN4P2N060	€ 23,00	60 mm	74 mm	48 mm	76 mm	1095 g

PN402Nx

EXTENSION BAR



Cr-V Chromed 3/4"

Art.	€	Length	Weight
PN402N200A	€ 15,20	200 mm	650 g
PN402N400A	€ 23,30	400 mm	940 g

LN400N3/4A

€ 25,00

SLIDING T BAR



Cr-V Chromed 3/4"

Length	500 mm
Weight	1542 g

RN4023NA

€ 6,90

ADAPTER

WITH 3/4" FEMALE AND 1/2" MALE DRIVES



Cr-V Chromed

Female and male Dr.	3/4" 1/2"
Length	50 mm
Weight	131 g

JN402NA

€ 34,60

UNIVERSAL JOINT



Cr-V Chromed 3/4"

Length	108 mm
Weight	590 g

0795/2

€ 51,50

MULTILOCK SOCKET SET

SUITABLE FOR METRIC, INCH, TORX AND XZN BOLT.



19 Pcs Cr-V 1/2"

Sizes	8 - 9 - 10 - 11 - 12 - 13 - 14 - 15 - 16 - 17 - 18 - 19 - 20 - 21 - 22 - 24 - 27 - 30 - 32 mm
Inch size	3/8" - 7/16" - 15/32" - 1/2" - 19/32" - 5/8" - 3/4" - 25/32" - 13/16" - 7/8" - 15/16" - 1-1/16" - 1-13/16" - 1-1/4"
Torx size	E12 - E14 - E16 - E18 - E20 - E22 - E24 - E26 - E28 - E30 - E34 - E38 - E40
XZN size	M12 - M14 - M16 - M18

0795/1

€ 18,70

MULTILOCK SOCKET SET

SUITABLE FOR METRIC, INCH, TORX AND XZN BOLT



19 Pcs Cr-V 1/4"

Sizes	4 - 4,5 - 5 - 5,5 - 6 - 7 - 8 - 9 - 10 - 11 - 12 - 13 - 14 mm
Inch size	5/32" - 7/32" - 1/4" - 5/16" - 11/32" - 3/8" - 7/16" - 15/32" - 1/2"
Torx size	E5 - E6 - E8 - E10 - E12 - E14 - E16 - E18
XZN size	M5 - M6 - M8 - M9 - M10 - M12 - M14 - M16 - M18

0195

€ 37,50

E SOCKET SET

SUITABLE FOR TORX BOLT



28 Pcs Cr-V

Torx size	1/4": E4 - E5 - E6 - E7 - E8 - E10 - E11 3/8": E4 - E5 - E6 - E7 - E8 - E10 - E11 - E12 - E14 - E16 - E18 - E20 1/2": E10 - E11 - E12 - E14 - E16 - E18 - E20 - E22 - E24
Weight	1,350 kg

0393

€ 63,30

"L" HEX SOCKET SPANNER



13 Pcs Cr-V 1/4"

Sizes	6 - 7 - 8 - 10 - 11 - 12 - 13 - 14 - 17 - 19 - 22 mm
-------	--

SN4E5C012

€ 47,70

LOW PROFILE 12 POINT SOCKET SET

COMPOSED OF 11 SOCKETS AND 1 60T RATCHET HANDLE, SUITABLE FOR OPERATIONS IN SMALL SPACES



12 Pcs Cr-V Chromed 1/4"

Socket	4, 5, 6, 7, 8, 9, 10, 11, 12, 13, 14 mm
--------	---

SN4E4C013

€ 62,30

LOW PROFILE 12 POINT SOCKET SET

COMPOSED OF 12 SOCKETS AND 1 60T RATCHET HANDLE, SUITABLE FOR OPERATIONS IN SMALL SPACES



13 Pcs Cr-V Chromed 3/8"

Socket	8, 9, 10, 11, 12, 13, 14, 15, 16, 17, 18, 19 mm
--------	---

SN4E3C015

€ 79,30

LOW PROFILE 12 POINT SOCKET SET

COMPOSED OF 14 SOCKETS AND 1 60T RATCHET HANDLE, SUITABLE FOR OPERATIONS IN SMALL SPACES



15 Pcs Cr-V Chromed 1/2"

Socket	8, 10, 11, 12, 13, 14, 15, 17, 18, 19, 21, 22, 23, 24 mm
--------	--



0589

€ 57,50

LOW PROFILE GO-THROUGH SPLINE SOCKET SET

COMPOSED OF 11 GO-THROUGH SPLINE SOCKETS, ONE 72T GO-THROUGH RATCHET HANDLE AND ACCESSORIES, SUITABLE FOR METRIC, INCH, TORX AND XZN SIZE, CAN OPERATE IN SMALL SPACES



24 Pcs Cr-V Chromed Blow mold case

Socket	4.5 - 5 - 5.5 - 6 - 7 - 8 - 9 - 10 - 11 - 12 - 13 mm
Ratchet handle	
Extension	50 mm
Socket	1/4"
Bit holder	
Bits	PH: 1 - 2 - 3 [S2] Torx: T10-T15-T20-T25-T30-T40 [S2]

0593

€ 52,10

LOW PROFILE GO-THROUGH SPLINE SOCKET SET

COMPOSED OF 10 GO-THROUGH SPLINE SOCKETS, ONE 72T GO-THROUGH RATCHET HANDLE AND ACCESSORIES, SUITABLE FOR METRIC AND INCH SIZE, TORX, XZN SIZE, CAN OPERATE IN SMALL SPACES



13 Pcs Cr-V Chromed Blow mold case

Socket	8 - 10 - 11 - 12 - 13 - 14 - 15 - 16 - 17 - 19 mm
Ratchet handle	
Extension	75 mm
Socket	3/8"

0624

€ 54,10

1/4" DR. SOCKET SET



46 Pcs Cr-V Chromed 1/4"

1/4" Dr. sockets	4 - 4.5 - 5 - 5.5 - 6 - 7 - 8 - 9 - 10 - 11 - 12 - 13 - 14 mm
Sockets with bits	1/4": T8 - T10 - T15 - T20 - T25 - T30 - T40 - H3 - H4 - H5 - H6 - H7 - H8 - SL4 - SL5.5 - SL7 - PH1 - PH2 - PH3 - PZ1 - PZ2 - PH3
Ratchet handle	1/4"
Flexible bar	1/4" - 150 mm
1/4" Dr. socket-bars	50 - 100 mm
Socket handle	1/4"
Universal joint	1/4"
Sliding T-bar	1/4"
Hex keys	1,27 - 1,5 - 2 - 2.5 mm

S520

€ 33,00

1/4" DR. 6 POINT SAE SOCKET SET



20 Pcs Cr-V Chromed

1/4" Dr. sockets	5/32", 3/16", 7/32", 1/4", 9/32" 5/16", 11/32", 3/8", 13/32", 7/16", 15/32", 1/2", 9/16"
Universal joint	1/4"
1/4" Dr. socket-bars	2", 4", 6"
Sliding T-bar	1/4"
Socket handle	1/4"
Ratchet handle	1/4"

0679

€ 61,90

3/8" AND 1/4" DR. SOCKET SET



42 Pcs Cr-V Satin finish 1/4"

3/8" Dr. sockets	9 - 10 - 11 - 12 - 13 - 14 - 15 - 17 - 19 mm
Spark plug sockets sizes	3/8" : 16 - 21 mm
3/8" Dr. socket-bars	75 - 150 mm
Universal joint	3/8"
Adapter	F. 1/2" - M. 3/8"
Ratchet handle	3/8"
1/4" Dr. sockets	4 - 4,5 - 5 - 5,5 - 6 - 7 - 8 - 9 - 10 - 11 - 12 - 13 mm
Socket handle	1/4"
Adapter	F. 3/8" - M. 1/4"
Bits holder socket	1/4"
Bits	PH1 - PH2 - PH3 - H3 - H4 - H5 - H6 - H7 - SL4 - SL5,5 - SL7

S328

€ 108,00

1/2" DR. SOCKET SET



28 Pcs Cr-V Chromed 1/2"

1/2" Dr. sockets	8 - 9 - 10 - 11 - 12 - 13 - 14 - 15 - 16 - 17 - 18 - 19 - 20 - 21 - 22 - 23 - 24 - 27 - 30 - 32 mm
Spark plug sockets sizes	1/2" : 16 - 21 mm
1/2" Dr. socket-bars	75 - 150 - 250 mm
Universal joint	1/2"
Adapter	F. 3/8" - M. 1/2"
Ratchet handle	1/2"

SN4P3N027

€ 95,80

1/2" DR. 6 POINT SAE SOCKET SET

COMPOSED OF 20 STANDARD SOCKETS, 2 SPARK PLUG SOCKETS, 1 RATCHET HANDLE, 1 UNIVERSAL JOINT, 2 EXTENSION BARS AND 1 SLIDING T-BAR



27 Pcs Cr-V Chromed 1/2"

Standard sockets sizes	5/16", 3/8", 7/16", 15/32", 1/2", 9/16", 19/32", 5/8", 11/16", 3/4", 25/32", 13/16", 7/8", 15/16", 1", 1-1/16", 1-3/16", 1-1/4", 23/32", 1-1/8"
Spark plug sockets sizes	5/8", 13/16"
Extension bars sizes	3", 10"

0620

€ 95,80

1/2" DR. SOCKET SET



24 Pcs Cr-V Chromed 1/2"

1/2" Dr. sockets	10 - 11 - 12 - 13 - 14 - 15 - 16 - 17 - 18 - 19 - 20 - 21 - 22 - 23 - 24 - 27 - 30 - 32 mm
Spark plug sockets sizes	1/2" : 21 mm
1/2" Dr. socket-bars	125 - 250 mm
Universal joint	1/2"
Sliding T-bar	1/2"
Ratchet handle	1/2"



0181
€ 128,00
3/4" DR. SOCKET SET

20 Pcs Satin finish 3/4"

Sizes	19 - 21 - 22 - 23 - 24 - 26 - 27 - 30 - 32 - 34 - 36 - 38 - 41 - 46 - 48 - 50 mm
Ratchet handle	3/4"
Sliding T-bar	3/4"
Extension bars	3/4" : 100 - 200 mm

0622
€ 40,80
SOCKET TORX BIT SET

10 Pcs Cr-V Satin finish 1/2"

Sizes	T20 - T25 - T27 - T30 - T40 T45 - T50 - T55 - T60 - T70
-------	---

S108
€ 144,00
1/4" & 1/2" DR. SOCKET SET

108 Pcs Cr-V Chromed

1/4" Dr. sockets	4 - 4.5 - 5 - 5.5 - 6 - 7 - 8 - 9 - 10 - 11 - 12 - 13 - 14 mm
1/4" Dr. deep sockets	6 - 7 - 8 - 9 - 10 - 11 - 12 - 13 mm
1/4" Dr. deep sockets	Torx: E4 - E5 - E6 - E7 - E8 mm
1/2" Dr. sockets	10 - 11 - 12 - 13 - 14 - 15 - 16 - 17 - 18 - 19 - 20 - 21 - 22 - 24 - 27 - 30 - 32 mm
1/2" Dr. deep sockets	14 - 15 - 17 - 19 - 22 mm
1/2" Dr. sockets	Torx: E10 - E11 - E12 - E14 - E16 - E18 - E20 - E24
Sockets with bits	1/4" : T8 - T10 - T15 - T20 - T25 - T27 - T30 - H3 - H4 - H5 - H6 - SL4 - SL5.5 - SL6.5 - PH1 - PH2 - PZ1 - PZ2
Spark plug sockets sizes	1/2" : 16 - 21 mm
Bits holder socket	1/2"
Bits	5/16" x 30mm : H7 - H8 - H10 - H12 - H14 - SL8 - SL10 - SL12 - PH3 - PH4 - PZ3 - PZ4 - T40 - T45 - T50 - T55 - T60
1/4" Dr. socket-bars	50 - 85 mm
1/2" Dr. socket-bars	125 - 250 mm
Socket handle	1/4"
Adapter	F. 3/8" - M. 1/2"
Universal joint	1/4"
Universal joint	1/2"
Sliding T-bar	1/4"
Ratchet handle	1/4"
Ratchet handle	1/2"
Hex keys	1.5 - 2 - 2.5 mm

0618
€ 159,00
1/2" & 1/4" DR. SOCKET SET

94 Pcs Cr-V Chromed

1/4" Dr. sockets	4 - 4.5 - 5 - 5.5 - 6 - 7 - 8 - 9 - 10 - 11 - 12 - 13 - 14 mm
1/4" Dr. deep sockets	6 - 7 - 8 - 9 - 10 - 11 - 12 - 13 mm
Male adapter 1/4" Dr. and 1/4" hex	
1/2" Dr. sockets	10 - 11 - 12 - 13 - 14 - 15 - 16 - 17 - 18 - 19 - 20 - 21 - 22 - 23 - 24 - 27 - 30 - 32 mm
1/2" Dr. deep sockets	14 - 15 - 17 - 19 mm
Flexible bar	1/4" - 150 mm
Sockets with bits	1/4" : T8 - T10 - T15 - T20 - T25 - T30 - H3 - H4 - H5 - H6 - SL4 - SL5.5 - SL7 - PH1 - PH2 - PZ1 - PZ2
Spark plug sockets sizes	1/2" : 16 - 21 mm
Socket for 5/16" inserts	1/2"
Bits	5/16" x 30mm : H8 - H10 - H12 - H14 - SL8 - SL10 - SL12 - PH3 - PH4 - PZ3 - PZ4 - T40 - T45 - T50 - T55
1/4" Dr. socket-bars	50 - 100 mm
1/2" Dr. socket-bars	125 - 250 mm
Socket handle	1/4"
Adapter	F. 3/8" - M. 1/2"
Universal joint	1/4"
Universal joint	1/2"
Sliding T-bar	1/4"
Ratchet handle	1/4"
Ratchet handle	1/2"
Hex keys	1.5 - 2 - 2.5 mm



S179

€ 247,00

1/4", 3/8" & 1/2" DR. SOCKET SET

179 Pcs Cr-V Chromed

1/4" Dr. sockets	4 - 4.5 - 5 - 5.5 - 6 - 7 - 8 - 9 - 10 - 11 - 12 - 13 - 14 mm
1/4" Dr. deep sockets	6 - 7 - 8 - 9 - 10 mm
1/4" Dr. deep sockets	Torx: E4 - E5 - E6 - E7 - E8 mm
1/4" Dr. socket-bars	50 - 100 mm
Sliding T-bar	1/4"
Bits holder socket	1/4"
Sockets with bits	1/4" - Torx: T8 - T9 - T10 - T15 - T20 - T25 - T27 - T30
Sockets with tampered bits	1/4" - Torx: T8H - T9H - T10H - T15H - T20H - T25H - T27H - T30H
Sockets with bits	1/4" : PH0 - PH1 - PH2
Sockets with bits	1/4" : PZ0 - PZ1 - PZ2
Sockets with hex bits	1/4" : 3 - 4 - 5 - 6 mm
Sockets with slotted bits	1/4" : 4 - 5.5 - 6.5 - 7 mm
Universal joint	1/4"
Socket handle	1/4"
Ratchet handle	1/4"
3/8" Dr. sockets	10 - 11 - 12 - 13 - 14 - 15 - 16 - 17 - 18 - 19 mm
3/8" Dr. sockets	Torx: E10 - E11 - E12 - E13
3/8" Dr. deep sockets	10 - 11 - 12 - 13 - 14 - 15 mm
Spark plug sockets sizes	3/8" - 18 mm
3/8" Dr. socket-bars	150 mm
Socket for 5/16" inserts	3/8"
Universal joint	3/8"
Ratchet handle	3/8"
1/2" Dr. sockets	10 - 11 - 12 - 13 - 14 - 15 - 16 - 17 - 18 - 19 - 20 - 21 - 22 - 24 - 27 - 30 - 32 mm
1/2" Dr. deep sockets	16 - 17 - 18 - 19 - 22 mm
1/2" Dr. sockets	Torx: E16 - E18 - E20 - E24
Spark plug sockets sizes	1/2" : 16 - 21 mm
1/2" Dr. socket-bars	125 - 250 mm
Socket for 5/16" inserts	1/2"
Universal joint	1/2"
Adapter	F. 3/8" - M. 1/2"
Ratchet handle	1/2"
Bits	1/4" x 25 mm XZN: M5 - M6 - M8



Bits	1/4" x 25 mm Torx: T5 - T6 - T7 - T8 - T9 - T10 - T15 - T20 - T25 - T27 - T30
Bits	1/4" x 25 mm Ribe: RM5 - RM6 - RM7 - RM8 - RM9
Bits	1/4" x 25 mm Torx "5": TS7 - TS10 - TS15 - TS20 - TS25 - TS27 - TS30 - TS40 - TS45
Bits	5/16" x 30 mm Torx: T40 - T45 - T50 - T55 - T60 - T70
Tampered bits	5/16" x 30 mm Torx: T40H - T45H - T50H - T55H - T60H - T70H
Hex bits	5/16" x 30 mm: 7 - 8 - 10 - 12 - 14 mm
Bits	5/16" x 30 mm: PH3 - PH4
Bits	5/16" x 30 mm: PZ3 - PZ4
Slotted bits	5/16" x 30 mm: 8 - 10 - 12 mm
Hex keys	1.3 - 1.5 - 2 - 2.5 - 3 - 4 - 5 mm

BI4E3Nx

STANDARD IMPACT SOCKET

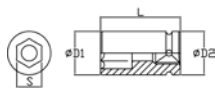

Cr-Mo Phosphated DIN 3129 1/2"

Art.	€	Size	Length	D1	D2
BI4E3N008	€ 3,25	8 mm	38 mm	15 mm	24 mm
BI4E3N009	€ 3,25	9 mm	38 mm	16 mm	24 mm
BI4E3N010	€ 3,25	10 mm	38 mm	17,5 mm	24 mm
BI4E3N011	€ 3,25	11 mm	38 mm	18,5 mm	24 mm
BI4E3N012	€ 3,25	12 mm	38 mm	19,5 mm	24 mm
BI4E3N013	€ 3,25	13 mm	38 mm	20,5 mm	24 mm
BI4E3N014	€ 3,25	14 mm	38 mm	22 mm	24 mm
BI4E3N015	€ 3,67	15 mm	38 mm	24 mm	24 mm
BI4E3N016	€ 3,67	16 mm	38 mm	24 mm	24 mm
BI4E3N017	€ 3,67	17 mm	38 mm	26 mm	26 mm
BI4E3N018	€ 3,67	18 mm	38 mm	28 mm	28 mm
BI4E3N019	€ 3,67	19 mm	38 mm	28 mm	28 mm
BI4E3N020	€ 4,45	20 mm	38 mm	30 mm	30 mm
BI4E3N021	€ 4,45	21 mm	38 mm	30 mm	30 mm
BI4E3N022	€ 4,45	22 mm	38 mm	32 mm	30 mm
BI4E3N023	€ 4,63	23 mm	38 mm	34 mm	30 mm
BI4E3N024	€ 4,63	24 mm	38 mm	34 mm	30 mm
BI4E3N025	€ 4,63	25 mm	38 mm	36 mm	30 mm
BI4E3N026	€ 5,20	26 mm	38 mm	36 mm	30 mm
BI4E3N027	€ 5,20	27 mm	42 mm	38 mm	30 mm
BI4E3N028	€ 6,20	28 mm	42 mm	40 mm	30 mm
BI4E3N029	€ 6,20	29 mm	42 mm	42 mm	30 mm
BI4E3N030	€ 6,70	30 mm	42 mm	42 mm	30 mm
BI4E3N031	€ 6,80	31 mm	42 mm	44 mm	30 mm
BI4E3N032	€ 7,50	32 mm	44 mm	44 mm	30 mm

BI4E3Lx

DEEP IMPACT SOCKET

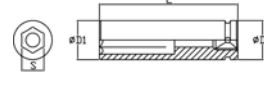

Cr-Mo Phosphated DIN 3129 1/2"

Art.	€	Size	Length	D1	D2
BI4E3L008	€ 5,40	8 mm	78 mm	15 mm	24 mm
BI4E3L009	€ 5,40	9 mm	78 mm	16 mm	24 mm
BI4E3L010	€ 5,40	10 mm	78 mm	17,5 mm	24 mm
BI4E3L011	€ 5,40	11 mm	78 mm	18,5 mm	24 mm
BI4E3L012	€ 5,40	12 mm	78 mm	19,5 mm	24 mm
BI4E3L013	€ 5,40	13 mm	78 mm	20,5 mm	24 mm
BI4E3L014	€ 5,40	14 mm	78 mm	22 mm	24 mm
BI4E3L015	€ 6,40	15 mm	78 mm	24 mm	24 mm
BI4E3L016	€ 6,40	16 mm	78 mm	24 mm	24 mm
BI4E3L017	€ 6,40	17 mm	78 mm	26 mm	26 mm
BI4E3L018	€ 6,40	18 mm	78 mm	28 mm	28 mm
BI4E3L019	€ 6,40	19 mm	78 mm	28 mm	28 mm
BI4E3L020	€ 6,40	20 mm	78 mm	30 mm	30 mm
BI4E3L021	€ 6,40	21 mm	78 mm	30 mm	30 mm
BI4E3L022	€ 6,70	22 mm	78 mm	32 mm	30 mm
BI4E3L023	€ 6,80	23 mm	78 mm	34 mm	30 mm
BI4E3L024	€ 7,80	24 mm	78 mm	34 mm	30 mm
BI4E3L025	€ 8,50	25 mm	78 mm	36 mm	30 mm
BI4E3L026	€ 8,70	26 mm	78 mm	36 mm	30 mm
BI4E3L027	€ 8,70	27 mm	78 mm	38 mm	30 mm
BI4E3L028	€ 9,20	28 mm	78 mm	40 mm	30 mm
BI4E3L029	€ 9,20	29 mm	78 mm	42 mm	30 mm
BI4E3L030	€ 9,20	30 mm	78 mm	42 mm	30 mm
BI4E3L031	€ 9,50	31 mm	78 mm	44 mm	30 mm
BI4E3L032	€ 9,50	32 mm	78 mm	44 mm	30 mm

BI413L0x

IMPACT 6 POINT BIT SOCKET



Cr-Mo Phosphated DIN 3129 1/2"

Art.	€	Size	Length	D
BI413L004	€ 5,10	4 mm	78 mm	25 mm
BI413L005	€ 5,10	5 mm	78 mm	25 mm
BI413L006	€ 5,10	6 mm	78 mm	25 mm
BI413L008	€ 5,10	8 mm	78 mm	25 mm
BI413L010	€ 5,10	10 mm	78 mm	25 mm
BI413L012	€ 5,10	12 mm	78 mm	25 mm
BI413L014	€ 5,10	14 mm	78 mm	25 mm
BI413L017	€ 5,70	17 mm	78 mm	25 mm
BI413L019	€ 6,20	19 mm	78 mm	25 mm

BI423Lx

IMPACT TORX BIT SOCKET

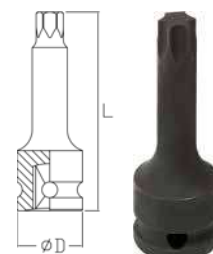

Cr-Mo Phosphated DIN 3121 & 3129 1/2"

Art.	€	Size	Length	D
BI423L025	€ 5,70	T25	78 mm	25 mm
BI423L027	€ 5,70	T27	78 mm	25 mm
BI423L030	€ 5,70	T30	78 mm	25 mm
BI423L040	€ 6,10	T40	78 mm	25 mm
BI423L045	€ 6,20	T45	78 mm	25 mm
BI423L050	€ 6,20	T50	78 mm	25 mm
BI423L060	€ 8,00	T60	78 mm	25 mm
BI423L070	€ 9,00	T70	78 mm	25 mm
BI423L080	€ 9,30	T80	78 mm	25 mm

BI433Mx

IMPACT RIBE BIT SOCKET

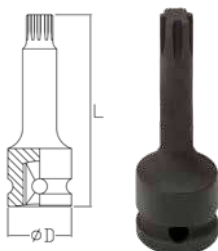

Cr-Mo Phosphated DIN 3121 & 3129 1/2"

Art.	€	Size	Length	D
BI433M004	€ 5,00	4	60 mm	25 mm
BI433M005	€ 5,00	5	60 mm	25 mm
BI433M006	€ 5,00	6	60 mm	25 mm
BI433M007	€ 5,00	7	60 mm	25 mm
BI433M008	€ 5,00	8	60 mm	25 mm
BI433M009	€ 5,00	9	60 mm	25 mm
BI433M010	€ 5,00	10	60 mm	25 mm
BI433M012	€ 5,70	12	60 mm	25 mm
BI433M014	€ 6,20	14	60 mm	25 mm
BI433M016	€ 6,40	16	60 mm	25 mm
BI433M018	€ 6,70	18	60 mm	25 mm

BI443Mx

IMPACT XZN BIT SOCKET

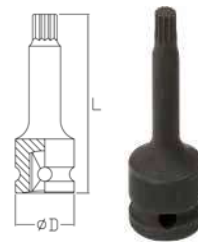

Cr-Mo Phosphated DIN 3121 & 3129 1/2"

Art.	€	Size	Length	D
BI443M004	€ 5,00	4	60 mm	25 mm
BI443M005	€ 5,00	5	60 mm	25 mm
BI443M006	€ 5,00	6	60 mm	25 mm
BI443M008	€ 5,00	8	60 mm	25 mm
BI443M010	€ 5,00	10	60 mm	25 mm
BI443M012	€ 5,00	12	60 mm	25 mm
BI443M014	€ 5,20	14	60 mm	25 mm
BI443M016	€ 5,40	16	60 mm	25 mm
BI443M018	€ 5,80	18	60 mm	25 mm
BI443M020	€ 6,20	20	60 mm	25 mm

PI403x

IMPACT EXTENSION BAR

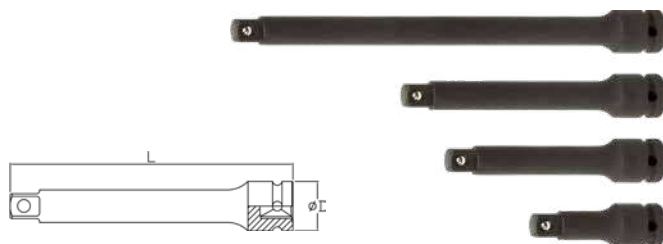

Cr-Mo Phosphated DIN 3121 & 3129 1/2"

Art.	€	Length	D
PI403075	€ 6,40	75 mm	25 mm
PI403125	€ 7,00	125 mm	25 mm
PI403150	€ 8,50	150 mm	25 mm
PI403250	€ 10,50	250 mm	25 mm

PI453x

QUICK RELEASE IMPACT EXTENSION BAR

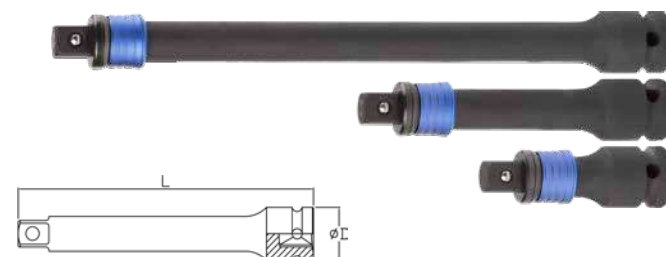

Cr-Mo Phosphated DIN 3121 & 3129 1/2"

Art.	€	Length	D
PI453075	€ 15,20	75 mm	25 mm
PI453150	€ 16,40	125 mm	25 mm
PI453250	€ 18,50	250 mm	25 mm

BI4E2Nx

STANDARD IMPACT SOCKET



Cr-Mo Phosphated DIN 3129 3/4"

Art.	€	Size	Length	D1	D2
BI4E2N018	€ 8,50	18 mm	51 mm	30 mm	44 mm
BI4E2N019	€ 8,50	19 mm	51 mm	32 mm	44 mm
BI4E2N020	€ 8,50	20 mm	51 mm	33 mm	44 mm
BI4E2N021	€ 8,50	21 mm	51 mm	35 mm	44 mm
BI4E2N022	€ 8,50	22 mm	51 mm	36 mm	44 mm
BI4E2N023	€ 8,50	23 mm	51 mm	38 mm	44 mm
BI4E2N024	€ 8,50	24 mm	51 mm	39 mm	44 mm
BI4E2N025	€ 8,50	25 mm	54 mm	41 mm	44 mm
BI4E2N026	€ 8,50	26 mm	54 mm	41 mm	44 mm
BI4E2N027	€ 8,50	27 mm	54 mm	42 mm	44 mm
BI4E2N028	€ 9,10	28 mm	54 mm	44 mm	44 mm
BI4E2N029	€ 9,10	29 mm	54 mm	46 mm	44 mm
BI4E2N030	€ 9,10	30 mm	54 mm	46 mm	44 mm
BI4E2N032	€ 10,10	32 mm	57 mm	48 mm	44 mm
BI4E2N033	€ 10,10	33 mm	57 mm	50 mm	44 mm
BI4E2N034	€ 10,90	34 mm	57 mm	52 mm	44 mm
BI4E2N035	€ 11,00	35 mm	57 mm	52 mm	44 mm
BI4E2N036	€ 11,20	36 mm	57 mm	54 mm	44 mm
BI4E2N038	€ 13,00	38 mm	57 mm	56 mm	44 mm
BI4E2N041	€ 14,50	41 mm	58 mm	60 mm	44 mm
BI4E2N046	€ 15,90	46 mm	68 mm	66 mm	44 mm
BI4E2N050	€ 24,80	50 mm	68 mm	71 mm	54 mm
BI4E2N055	€ 30,30	55 mm	73 mm	77 mm	54 mm
BI4E2N060	€ 32,90	60 mm	75 mm	84 mm	54 mm
BI4E2N065	€ 36,80	65 mm	78 mm	88 mm	54 mm

BI4E2Lx

DEEP IMPACT SOCKET

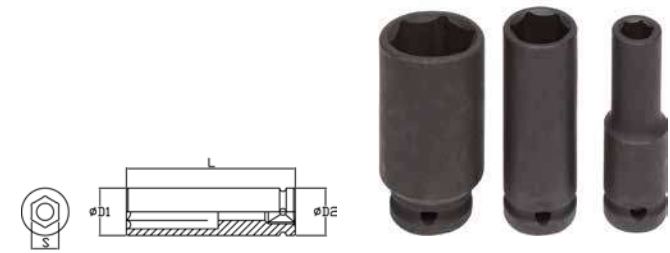

Cr-Mo Phosphated DIN 3129 3/4"

Art.	€	Size	Length	D1	D2
BI4E2L018	€ 15,20	18 mm	90 mm	30 mm	44 mm
BI4E2L019	€ 15,20	19 mm	90 mm	32 mm	44 mm
BI4E2L020	€ 15,20	20 mm	90 mm	33 mm	44 mm
BI4E2L021	€ 15,20	21 mm	90 mm	35 mm	44 mm
BI4E2L022	€ 15,20	22 mm	90 mm	36 mm	44 mm
BI4E2L023	€ 15,20	23 mm	90 mm	38 mm	44 mm
BI4E2L024	€ 15,20	24 mm	90 mm	39 mm	44 mm
BI4E2L025	€ 15,20	25 mm	90 mm	41 mm	44 mm
BI4E2L026	€ 15,20	26 mm	90 mm	41 mm	44 mm
BI4E2L027	€ 15,20	27 mm	90 mm	42 mm	44 mm
BI4E2L028	€ 15,20	28 mm	90 mm	44 mm	44 mm
BI4E2L029	€ 15,20	29 mm	90 mm	46 mm	44 mm
BI4E2L030	€ 15,20	30 mm	90 mm	46 mm	44 mm
BI4E2L032	€ 16,30	32 mm	90 mm	48 mm	44 mm
BI4E2L033	€ 16,30	33 mm	90 mm	50 mm	44 mm
BI4E2L034	€ 16,70	34 mm	90 mm	52 mm	44 mm
BI4E2L035	€ 16,70	35 mm	90 mm	52 mm	44 mm
BI4E2L036	€ 16,70	36 mm	90 mm	54 mm	44 mm
BI4E2L038	€ 19,80	38 mm	90 mm	56 mm	44 mm
BI4E2L041	€ 20,90	41 mm	90 mm	60 mm	44 mm
BI4E2L046	€ 27,20	46 mm	90 mm	66 mm	44 mm
BI4E2L050	€ 33,80	50 mm	90 mm	71 mm	54 mm

PI402x

IMPACT EXTENSION BAR

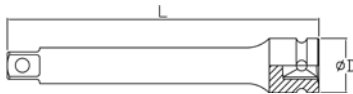

Cr-Mo Phosphated DIN 3121 & 3129 3/4"

Art.	€	Length	D
PI402175	€ 24,20	175 mm	44 mm
PI402200	€ 26,70	200 mm	44 mm
PI402300	€ 35,00	300 mm	44 mm
PI402400	€ 49,50	400 mm	44 mm



BI4E1Nx
STANDARD IMPACT SOCKET

Cr-Mo



Phosphated



DIN 3129



1"

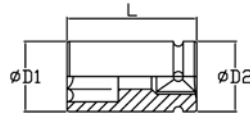

Art.	€	Size	Length	D1	D2
BI4E1N021	€ 15,70	21 mm	58 mm	38 mm	54 mm
BI4E1N022	€ 15,70	22 mm	58 mm	39 mm	54 mm
BI4E1N023	€ 15,70	23 mm	58 mm	41 mm	54 mm
BI4E1N024	€ 15,70	24 mm	58 mm	42 mm	54 mm
BI4E1N025	€ 15,70	25 mm	58 mm	43 mm	54 mm
BI4E1N026	€ 15,70	26 mm	58 mm	44 mm	54 mm
BI4E1N027	€ 15,70	27 mm	58 mm	46 mm	54 mm
BI4E1N028	€ 15,70	28 mm	58 mm	47 mm	54 mm
BI4E1N029	€ 15,70	29 mm	58 mm	48 mm	54 mm
BI4E1N030	€ 15,70	30 mm	62 mm	49 mm	54 mm
BI4E1N031	€ 15,70	31 mm	62 mm	50 mm	54 mm
BI4E1N032	€ 15,70	32 mm	62 mm	52 mm	54 mm
BI4E1N033	€ 15,70	33 mm	62 mm	54 mm	54 mm
BI4E1N034	€ 17,40	34 mm	62 mm	54 mm	54 mm
BI4E1N035	€ 17,40	35 mm	62 mm	54 mm	54 mm
BI4E1N036	€ 18,00	36 mm	65 mm	56 mm	54 mm
BI4E1N037	€ 18,40	37 mm	65 mm	57 mm	54 mm
BI4E1N038	€ 20,70	38 mm	65 mm	58 mm	54 mm
BI4E1N039	€ 20,70	39 mm	65 mm	59 mm	54 mm
BI4E1N040	€ 20,70	40 mm	65 mm	60 mm	54 mm
BI4E1N041	€ 20,70	41 mm	68 mm	61 mm	54 mm

Art.	€	Size	Length	D1	D2
BI4E1N042	€ 23,20	42 mm	68 mm	64 mm	54 mm
BI4E1N043	€ 23,20	43 mm	68 mm	66 mm	54 mm
BI4E1N044	€ 23,20	44 mm	68 mm	66 mm	54 mm
BI4E1N045	€ 23,20	45 mm	68 mm	67 mm	54 mm
BI4E1N046	€ 23,20	46 mm	72 mm	68 mm	54 mm
BI4E1N047	€ 25,90	47 mm	72 mm	69 mm	54 mm
BI4E1N048	€ 25,90	48 mm	72 mm	70 mm	54 mm
BI4E1N050	€ 25,90	50 mm	75 mm	74 mm	54 mm
BI4E1N052	€ 32,20	52 mm	75 mm	75 mm	54 mm
BI4E1N054	€ 32,20	54 mm	80 mm	78 mm	54 mm
BI4E1N055	€ 33,40	55 mm	83 mm	80 mm	54 mm
BI4E1N056	€ 35,90	56 mm	83 mm	81 mm	54 mm
BI4E1N060	€ 35,90	60 mm	87 mm	86 mm	54 mm
BI4E1N065	€ 39,10	65 mm	90 mm	92 mm	54 mm
BI4E1N070	€ 44,00	70 mm	93 mm	97 mm	54 mm
BI4E1N075	€ 52,00	75 mm	95 mm	104 mm	86 mm
BI4E1N080	€ 73,30	80 mm	95 mm	112 mm	86 mm
BI4E1N085	€ 84,30	85 mm	100 mm	115 mm	86 mm
BI4E1N090	€ 94,20	90 mm	105 mm	124 mm	86 mm
BI4E1N095	€ 118,00	95 mm	105 mm	130 mm	86 mm
BI4E1N100	€ 146,00	100 mm	105 mm	135 mm	86 mm

BI4E1Lx
DEEP IMPACT SOCKET

Cr-Mo



Phosphated



DIN 3129



1"

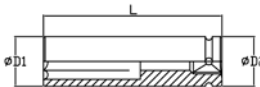

Art.	€	Size	Length	D1	D2
BI4E1L021	€ 21,80	21 mm	90 mm	38 mm	54 mm
BI4E1L022	€ 21,80	22 mm	90 mm	39 mm	54 mm
BI4E1L023	€ 21,80	23 mm	90 mm	41 mm	54 mm
BI4E1L024	€ 21,80	24 mm	90 mm	42 mm	54 mm
BI4E1L027	€ 21,80	27 mm	90 mm	46 mm	54 mm
BI4E1L028	€ 21,80	28 mm	90 mm	47 mm	54 mm
BI4E1L030	€ 21,80	30 mm	90 mm	49 mm	54 mm
BI4E1L032	€ 21,80	32 mm	90 mm	52 mm	54 mm
BI4E1L033	€ 21,80	33 mm	90 mm	54 mm	54 mm
BI4E1L034	€ 22,00	34 mm	90 mm	54 mm	54 mm
BI4E1L035	€ 22,20	35 mm	90 mm	54 mm	54 mm
BI4E1L036	€ 22,20	36 mm	90 mm	56 mm	54 mm
BI4E1L038	€ 25,60	38 mm	95 mm	58 mm	54 mm
BI4E1L039	€ 26,80	39 mm	95 mm	59 mm	54 mm
BI4E1L040	€ 26,80	40 mm	95 mm	60 mm	54 mm
BI4E1L041	€ 27,50	41 mm	95 mm	61 mm	54 mm
BI4E1L042	€ 27,50	42 mm	95 mm	64 mm	54 mm
BI4E1L043	€ 29,10	43 mm	95 mm	66 mm	54 mm

Art.	€	Size	Length	D1	D2
BI4E1L044	€ 29,10	44 mm	95 mm	66 mm	54 mm
BI4E1L045	€ 29,70	45 mm	95 mm	67 mm	54 mm
BI4E1L046	€ 29,70	46 mm	95 mm	68 mm	54 mm
BI4E1L048	€ 36,30	48 mm	100 mm	70 mm	54 mm
BI4E1L049	€ 37,50	49 mm	100 mm	72 mm	54 mm
BI4E1L050	€ 37,50	50 mm	100 mm	74 mm	54 mm
BI4E1L051	€ 38,70	51 mm	100 mm	74 mm	54 mm
BI4E1L052	€ 39,30	52 mm	100 mm	74 mm	54 mm
BI4E1L054	€ 39,30	54 mm	100 mm	78 mm	54 mm
BI4E1L055	€ 42,30	55 mm	105 mm	80 mm	54 mm
BI4E1L057	€ 44,10	57 mm	105 mm	82 mm	54 mm
BI4E1L060	€ 58,40	60 mm	110 mm	86 mm	54 mm
BI4E1L065	€ 70,10	65 mm	115 mm	92 mm	54 mm
BI4E1L070	€ 69,90	70 mm	120 mm	97 mm	54 mm
BI4E1L075	€ 102,00	75 mm	135 mm	104 mm	86 mm
BI4E1L080	€ 110,00	80 mm	135 mm	112 mm	86 mm
BI4E1L085	€ 116,00	85 mm	140 mm	115 mm	86 mm
BI4E1L090	€ 152,00	90 mm	140 mm	124 mm	86 mm
BI4E1L095	€ 198,00	95 mm	140 mm	130 mm	86 mm

I340

€ 189,00

STANDARD & DEEP IMPACT SOCKET SET



40 Pcs Cr-Mo Phosphated 1/2"

1/2" Dr. sockets	9 - 10 - 11 - 12 - 13 - 14 - 15 - 16 - 17 - 18 - 19 - 20 - 21 - 22 - 23 - 24 - 26 - 27 - 30 mm
1/2" Dr. deep sockets	9 - 10 - 11 - 12 - 13 - 14 - 15 - 16 - 17 - 18 - 19 - 20 - 21 - 22 - 23 - 24 - 26 - 27 - 30 mm
Universal joint	1/2"
1/2" Dr. socket-bars	125 mm

SI4E3N013

€ 47,70

STANDARD IMPACT SOCKET SET

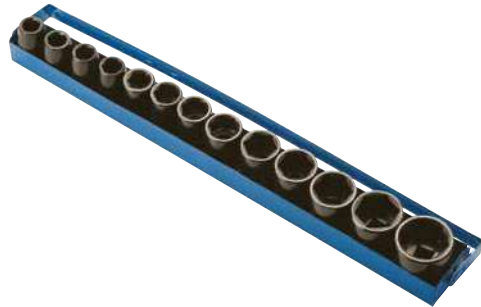

13 Pcs Cr-Mo Phosphated DIN 3129 1/2"

Socket	10, 11, 12, 13, 14, 16, 17, 19, 21, 22, 24, 27, 30 mm
--------	---

SI413M006

€ 41,70

IMPACT HEX BIT SOCKET SET



6 Pcs Cr-Mo Phosphated DIN 3129 1/2"

Length	60 mm
Socket	8, 10, 12, 14, 17, 19 mm

SI423M006

€ 47,70

IMPACT TORX BIT SOCKET SET



6 Pcs Cr-Mo Phosphated DIN 3129 1/2"

Length	60 mm
Socket	T40, T45, T50, T55, T60, T70

0341-x

CAT 42

IMPACT HEX SOCKET WITH PLASTIC SLEEVE



Cr-Mo 1/2"

Art.	€	Size	Length
0341/17	€ 7,10	17 mm	87 mm
0341/19	€ 7,10	19 mm	87 mm
0341/21	€ 7,10	21 mm	87 mm
0341/22	€ 8,80	22 mm	87 mm
0341/24	€ 10,00	24 mm	87 mm

0341

€ 29,70

DEEP IMPACT HEX SOCKET SET WITH PLASTIC SLEEVE



3 Pcs Cr-Mo 1/2"

Sizes	17 - 19 - 21 mm
Length	87 mm



0341/5S

CAT 42 € 41,70

IMPACT HEX SOCKET SET WITH PLASTIC SLEEVE



5 Pcs Cr-Mo 1/2"

Sizes	17 - 19 - 21 - 22 - 24 mm
Length	87 mm

0341/xL

CAT 42

LONG IMPACT HEX SOCKET WITH PLASTIC SLEEVE



Cr-Mo 1/2"

Art.	€	Size	Length
0341/17L	€ 13,80	17 mm	150 mm
0341/19L	€ 13,80	19 mm	150 mm
0341/21L	€ 13,80	21 mm	150 mm

0341/3LS

CAT 42 € 45,80

IMPACT HEX SOCKET SET WITH PLASTIC SLEEVE



3 Pcs Cr-Mo 1/2"

Sizes	17 - 19 - 21 mm
Length	150 mm

0341/Sx

CAT 42

PLASTIC SLEEVE FOR HEX IMPACT SOCKETS



Art.	€	Size
0341/S17	€ 0,83	17 mm
0341/S19	€ 0,83	19 mm
0341/S21	€ 0,83	21 mm
0341/S22	€ 0,83	22 mm
0341/S24	€ 0,83	24 mm

1306

€ 56,70

LONG IMPACT SOCKET SET



3 Pcs Cr-Mo 1/2"

Sizes	17 - 19 - 21 mm
Length	150 mm

1217

€ 249,00

METRIC STANDARD IMPACT SOCKET SET



17 Pcs Cr-Mo Phosphated 3/4"

3/4" Dr. sockets	19 - 21 - 22 - 24 - 27 - 30 - 32 - 33 - 34 - 35 - 36 - 38 - 40 - 41 - 46 - 50 - 55 mm
------------------	---

SI4E2N008

€ 88,30

STANDARD IMPACT SOCKET SET

6 POINT SOCKET SET



8 Pcs Cr-Mo Phosphated DIN 3129 3/4"

Socket 26, 27, 29, 30, 32, 35, 36, 38 mm

SI4E1N008

€ 130,00

STANDARD IMPACT SOCKET SET

6 POINT SOCKET SET



8 Pcs Cr-Mo Phosphated DIN 3129 1"

Socket 24, 27, 30, 32, 33, 36, 38, 41 mm

JI40xL

IMPACT UNIVERSAL JOINT



Cr-Mo Phosphated

Art.	€	Dr.	Length	D
JI401L	€ 68,10	1"	130 mm	54 mm
JI402L	€ 42,60	3/4"	105 mm	44 mm

JI40xN

IMPACT UNIVERSAL JOINT



Cr-Mo Phosphated

Art.	€	Dr.	Length	D
JI401N	€ 68,10	1"	115 mm	54 mm
JI402N	€ 42,60	3/4"	90 mm	44 mm
JI403N	€ 18,00	1/2"	63 mm	30 mm

I109

€ 142,00

IMPACT SOCKET SET



9 Pcs Cr-Mo Phosphated DIN 3129 1"

1" Dr. sockets 21 - 22 - 24 - 26 - 30 - 38 mm
1" Dr. deep sockets 27 - 28 - 32 mm

PI401x

IMPACT EXTENSION BAR

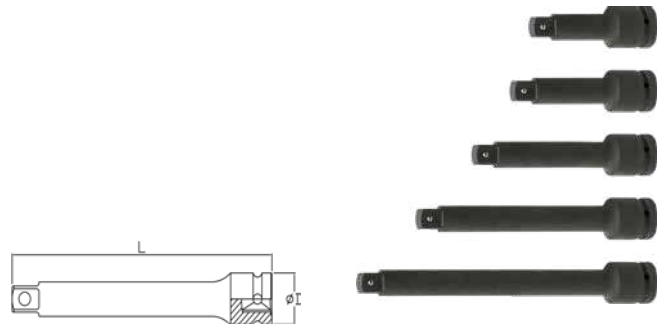

Cr-Mo Phosphated DIN 3121 - 3129 1"

Art.	€	Dr.	Length	D
PI401175	€ 33,30	1"	175 mm	54 mm
PI401200	€ 35,80	1"	200 mm	54 mm
PI401250	€ 43,30	1"	250 mm	54 mm
PI401300	€ 46,10	1"	300 mm	54 mm
PI401400	€ 58,40	1"	400 mm	54 mm

RI40x

IMPACT ADAPTER

1" FEMALE AND 3/4" MALE DR.



Cr-Mo Phosphated DIN 3121

Art.	€	Female junction	Shank	Length	D
RI4012N	€ 15,80	1"	3/4"	70 mm	54 mm
RI4021N	€ 12,60	3/4"	1"	63 mm	44 mm
RI4023N	€ 9,80	3/4"	1/2"	58 mm	44 mm
RI4032N	€ 7,00	1/2"	3/4"	48 mm	30 mm

SI40N006

€ 30,00

IMPACT ADAPTER SET



6 Pcs Cr-Mo Phosphated

Sizes 1/4" int. - 3/8" ext.; 3/8" int. - 1/4" ext.; 3/8" int. - 1/2" ext.; 1/2" int. - 3/8" ext.; 1/2" int. - 3/4" ext.; 3/4" int. - 1/2" ext.

Blow mould case 126 x 100 x 52 mm

Weight 0.78 kg

AI401NSx

SOCKET LOCKING PIN

USEFUL FOR STOPPING THE SOCKET ON THE IMPACT WRENCH



Cr-Mo

Art.	€	Dr.	Socket	Length	D
AI401NS45	€ 0,67	1"	17÷70 mm	45 mm	5 mm
AI401NS75	€ 1,48	1"	71÷95 mm	75 mm	5 mm
AI402NS35	€ 0,67	3/4"	17÷48 mm	35 mm	4 mm
AI402NS45	€ 0,67	3/4"	50÷70 mm	45 mm	4 mm
AI403NS20	€ 0,57	1/2"	8÷14 mm	20 mm	3 mm
AI403NS25	€ 0,57	1/2"	15÷38 mm	25 mm	3 mm

0853

€ 24,60

FLEXIBLE MAGNETIC LED FLASHLIGHT WITH MAGNETIC BASE



Blister

Sizes Ø9 / 19 x 440 mm

Weight 80 g

AI401NAx

SOCKET O-RING

USEFUL FOR STOPPING THE LOCKING PIN

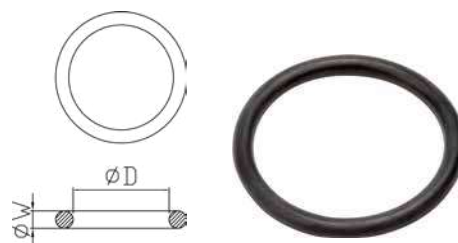

Art.	€	Dr.	Socket	D	W
AI401NA44	€ 1,48	3/4" 1"	17÷70 mm	44 mm	5,7 mm
AI401NA75	€ 2,00	3/4" 1"	75÷100 mm	75 mm	5,7 mm
AI402NA36	€ 1,02	3/4"	17÷48 mm	36 mm	5 mm
AI402NA46	€ 1,48	3/4"	50÷70 mm	46 mm	5 mm
AI403NA19	€ 0,58	1/2"	8÷14 mm	19 mm	4 mm
AI403NA24	€ 0,58	1/2"	15÷38 mm	24 mm	4 mm

0088

€ 13,80

MAGNETIC EXTRACTOR WITH LIGHT



Aluminium Blister

Sizes ø 9 / 17 x 430 mm

Not included batteries 2 x 1.5 V AA

Weight 85 g

0471

€ 4,75

O-RING REMOVAL SET

WITH CARBON STEEL TIPS AND POLYPROPYLENE HANDLE, ALSO SUITABLE FOR REMOVING MOTOR SEALS

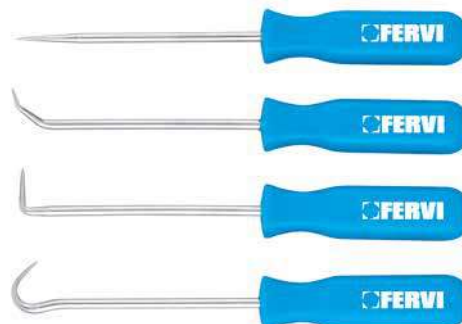

4 Pcs

Length 135 mm

E0456

€ 4,75

O RING HOOK SET

MADE OF CHROMED STEEL, EQUIPPED OF HEX HANDLE WITH MAGNET

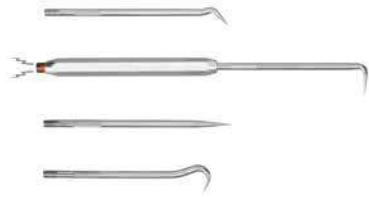

4 Pcs

Handle dimensions 8 x 90 mm

E003

€ 17,30

5-PC 1/4" CONNECTION HSS SCREW EXTRACTOR SET



5 Pcs HSS

num. 0	2-3 mm
num. 1	4-5 mm
num. 2	6-8 mm
num. 3	8-10 mm
num. 4	10-12 mm

E001

€ 11,30

SCREW EXTRACTOR SET



5 Pcs

num. 1	M3 - M6
num. 2	M6 - M8
num. 3	M8 - M11
num. 4	M11 - M14
num. 5	M14 - M18

E005

€ 28,30

BOLT REMOVER SET

WITH 3/8" DRIVE AND EXTERNAL HEX



11 Pcs Cr-Mo Plastic box

Sizes	9 - 10 - 11 - 12 - 13 - 14 - 15 - 16 - 17 - 19 mm
Height	27 mm

E191-

3 JAW GEAR PULLER



Art.	€	Overall sizes
E191/120	€ 46,30	Max Ø 120 mm - h 108 mm
E191/200	€ 86,70	Max Ø 200 mm - h 150 mm

E190-Bx

EXTENDED JAWS



Art.	€	Length
E190/B2	€ 23,20	300 mm

E190-

2 JAW GEAR PULLER



Art.	€	Overall sizes
E190/080	€ 24,10	Max Ø 80 mm - h 100 mm
E190/130	€ 31,50	Max Ø 130 mm - h 100 mm
E190/160	€ 38,80	Max Ø 160 mm - h 150 mm
E190/200	€ 41,80	Max Ø 200 mm - h 150 mm



CB01-

NUT DRIVER WITH PLASTIC HANDLE

WITH HANGER

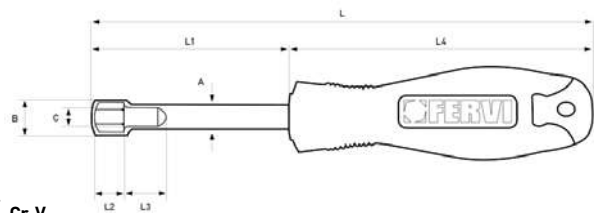

Cr-V

Art.	€	Size	L	L1	L2	L3	L4	A	B	C
CB01/04	€ 5,00	4 mm	185 mm	75 mm	4 - 5 mm	20,5 mm	110 mm	ø 5,9 mm	ø 7 mm	ø 3,3 mm
CB01/05	€ 5,00	5 mm	185 mm	75 mm	4,5 - 5,5 mm	20 mm	110 mm	ø 5,9 mm	ø 8,3 mm	ø 3,7 mm
CB01/055	€ 5,00	5,5 mm	185 mm	75 mm	5,5 - 6,5 mm	19 mm	110 mm	ø 5,9 mm	ø 9 mm	ø 3,7 mm
CB01/06	€ 5,00	6 mm	185 mm	75 mm	6,5 - 7,5 mm	18 mm	110 mm	ø 5,9 mm	ø 9,5 mm	ø 3,7 mm
CB01/07	€ 5,40	7 mm	185 mm	75 mm	7,5 - 8,5 mm	17 mm	110 mm	ø 5,9 mm	ø 10,5 mm	ø 3,7 mm
CB01/08	€ 5,40	8 mm	185 mm	75 mm	8,5 - 9,5 mm	16 mm	110 mm	ø 7,2 mm	ø 11,9 mm	ø 5 mm
CB01/09	€ 5,40	9 mm	185 mm	75 mm	8,5 - 9,5 mm	16 mm	110 mm	ø 7,2 mm	ø 12,8 mm	ø 5 mm
CB01/10	€ 5,80	10 mm	185 mm	75 mm	10,5 - 11,5 mm	14 mm	110 mm	ø 9,3 mm	ø 14,1 mm	ø 7 mm
CB01/11	€ 5,80	11 mm	185 mm	75 mm	10,5 - 11,5 mm	14 mm	110 mm	ø 9,3 mm	ø 15 mm	ø 7 mm
CB01/12	€ 5,80	12 mm	185 mm	75 mm	10,5 - 11,5 mm	14 mm	110 mm	ø 9,3 mm	ø 16 mm	ø 7 mm
CB01/13	€ 5,80	13 mm	185 mm	75 mm	11,5 - 12,5 mm	14 mm	110 mm	ø 11 mm	ø 17 mm	ø 8,5 mm

CB02-

HOLLOW NUT DRIVER WITH PLASTIC HANDLE

CHROME-VANADIUM WITH HANGER

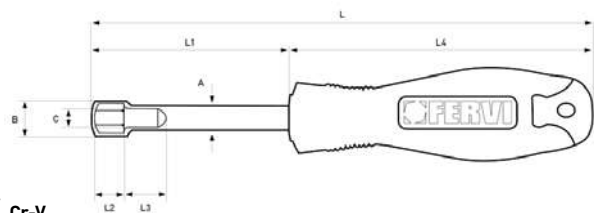

Cr-V

Art.	€	Size	L	L1	L2	L3	L4	A	B	C
CB02/04	€ 6,30	4 mm	185 mm	75 mm	4 - 5 mm	105,5 mm	110 mm	ø 7,2 mm	ø 7 mm	ø 3,3 mm
CB02/05	€ 6,30	5 mm	185 mm	75 mm	4,5 - 5,5 mm	105 mm	110 mm	ø 7,2 mm	ø 8,3 mm	ø 3,7 mm
CB02/055	€ 6,30	5,5 mm	185 mm	75 mm	5,5 - 6,5 mm	104 mm	110 mm	ø 7,2 mm	ø 9 mm	ø 3,7 mm
CB02/06	€ 6,30	6 mm	185 mm	75 mm	6,5 - 7,5 mm	103 mm	110 mm	ø 7,2 mm	ø 9,5 mm	ø 3,7 mm
CB02/07	€ 6,70	7 mm	185 mm	75 mm	7,5 - 8,5 mm	102 mm	110 mm	ø 7,2 mm	ø 10,5 mm	ø 3,7 mm
CB02/08	€ 6,70	8 mm	185 mm	75 mm	8,5 - 9,5 mm	101 mm	110 mm	ø 9,3 mm	ø 11,9 mm	ø 5 mm
CB02/09	€ 6,70	9 mm	185 mm	75 mm	8,5 - 9,5 mm	101 mm	110 mm	ø 9,3 mm	ø 12,8 mm	ø 5 mm
CB02/10	€ 6,70	10 mm	185 mm	75 mm	10,5 - 11,5 mm	100 mm	110 mm	ø 9,3 mm	ø 14,1 mm	ø 7 mm
CB02/11	€ 7,50	11 mm	185 mm	75 mm	10,5 - 11,5 mm	100 mm	110 mm	ø 11 mm	ø 15 mm	ø 7 mm
CB02/12	€ 7,50	12 mm	185 mm	75 mm	10,5 - 11,5 mm	100 mm	110 mm	ø 11 mm	ø 16 mm	ø 7 mm
CB02/13	€ 8,30	13 mm	185 mm	75 mm	11,5 - 12,5 mm	99 mm	110 mm	ø 11 mm	ø 17 mm	ø 8,5 mm

CBF1-

FLEXIBLE NUT DRIVER WITH PLASTIC HANDLE

WITH HANGER

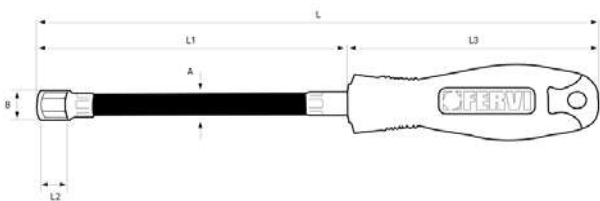

Art.	€	Size	L	L1	L2	L3	A	B
CBF1/05	€ 6,30	5 mm	265 mm	150 mm	9,5 mm	115 mm	ø 11 mm	ø 11,8 mm
CBF1/055	€ 6,30	5,5 mm	265 mm	150 mm	9,5 mm	115 mm	ø 11 mm	ø 11,8 mm
CBF1/06	€ 6,30	6 mm	265 mm	150 mm	9,5 mm	115 mm	ø 11 mm	ø 11,8 mm
CBF1/07	€ 6,30	7 mm	265 mm	150 mm	9,5 mm	115 mm	ø 11 mm	ø 11,8 mm
CBF1/08	€ 6,30	8 mm	265 mm	150 mm	9,5 mm	115 mm	ø 11 mm	ø 11,8 mm
CBF1/09	€ 6,40	9 mm	265 mm	150 mm	9,5 mm	115 mm	ø 11 mm	ø 13 mm
CBF1/10	€ 6,70	10 mm	265 mm	150 mm	10 mm	115 mm	ø 11 mm	ø 14,5 mm
CBF1/11	€ 7,10	11 mm	265 mm	150 mm	9 mm	115 mm	ø 11 mm	ø 15,9 mm
CBF1/12	€ 7,10	12 mm	265 mm	150 mm	9 mm	115 mm	ø 11 mm	ø 17 mm
CBF1/13	€ 7,10	13 mm	265 mm	150 mm	8,5 mm	115 mm	ø 11 mm	ø 17,8 mm

CBF1/10P

€ 61,70

FLEXIBLE NUT DRIVER SET WITH PLASTIC HANDLE



10 Pcs Color box

Sizes 5 - 5.5 - 6 - 7 - 8 - 9 - 10 - 11 - 12 - 13 mm

CB01/04P

€ 22,90

NUT DRIVER SET WITH PLASTIC HANDLE



4 Pcs Cr-V Color box

Sizes 10 - 11 - 12 - 13 mm

CB01/07P

€ 35,00

NUT DRIVER SET WITH PLASTIC HANDLE



7 Pcs Cr-V Color box

Sizes 4 - 5 - 5.5 - 6 - 7 - 8 - 9 mm

CB01/11P

€ 56,70

NUT DRIVER SET WITH PLASTIC HANDLE



11 Pcs Cr-V Color box

Sizes 4 - 5 - 5.5 - 6 - 7 - 8 - 9 - 10 - 11 - 12 - 13 mm

CB02/04P

€ 29,20

HOLLOW NUT DRIVER SET WITH PLASTIC HANDLE WITH DEEP HOLE



4 Pcs Cr-V Color box

Sizes 10 - 11 - 12 - 13 mm

CB02/07P

€ 45,80

HOLLOW NUT DRIVER SET WITH PLASTIC HANDLE WITH DEEP HOLE



7 Pcs Cr-V Color box

Sizes 4 - 5 - 5.5 - 6 - 7 - 8 - 9 - 10 mm

CB02/11P

€ 74,20

HOLLOW NUT DRIVER SET WITH PLASTIC HANDLE WITH DEEP HOLE



11 Pcs Cr-V Color box

Sizes 4 - 5 - 5.5 - 6 - 7 - 8 - 9 - 10 - 11 - 12 - 13 mm



D883-

CAT 42

ELECTRICIAN FLAT SCREWDRIVER WITH DIAMOND TIP

WITH BLACK BLADE AND TRICOMPONENT HANDLE MADE OF HIGHLY ELASTIC TPR RESIN AND OIL-RESISTANT POLYPROPYLENE MATERIAL. THE DIAMOND TIP ALLOWS A PERFECT GRIP, AVOIDING TO RUIN THE HEAD OF THE SCREW. THIS TYPE OF TIP IS ALSO VERY EFFECTIVE WITH ALREADY RUINED SCREWS.



S2 Mo-V

Art.	€	Size
D883/3075	€ 2,58	3 x 75 mm
D883/4100	€ 3,50	4 x 100 mm

D884-

CAT 42

FLAT SCREWDRIVER WITH DIAMOND TIP

WITH BLACK BLADE AND TRICOMPONENT HANDLE MADE OF HIGHLY ELASTIC TPR RESIN AND OIL-RESISTANT POLYPROPYLENE MATERIAL. THE DIAMOND TIP ALLOWS A PERFECT GRIP, AVOIDING TO RUIN THE HEAD OF THE SCREW. THIS TYPE OF TIP IS ALSO VERY EFFECTIVE WITH ALREADY RUINED SCREWS.



S2 Mo-V

Art.	€	Size
D884/3075	€ 2,75	3 x 75 mm
D884/4100	€ 3,33	4 x 100 mm
D884/5125	€ 3,75	5 x 125 mm
D884/6150	€ 4,33	6 x 150 mm
D884/8150	€ 5,30	8 x 150 mm

D884/6038

CAT 42 € 3,25

FLAT SCREWDRIVER WITH DIAMOND TIP

WITH BLACK BLADE AND TRICOMPONENT HANDLE MADE OF HIGHLY ELASTIC TPR RESIN AND OIL-RESISTANT POLYPROPYLENE MATERIAL. THE DIAMOND TIP ALLOWS A PERFECT GRIP, AVOIDING TO RUIN THE HEAD OF THE SCREW. THIS TYPE OF TIP IS ALSO VERY EFFECTIVE WITH ALREADY RUINED SCREWS.



S2 Mo-V

Size	€
6 x 38 mm	€ 3,25

D882-

CAT 42

CROSS SCREWDRIVER PH WITH DIAMOND TIP

WITH BLACK BLADE AND TRICOMPONENT HANDLE MADE OF HIGHLY ELASTIC TPR RESIN AND OIL-RESISTANT POLYPROPYLENE MATERIAL. THE DIAMOND TIP ALLOWS A PERFECT GRIP, AVOIDING TO RUIN THE HEAD OF THE SCREW. THIS TYPE OF TIP IS ALSO VERY EFFECTIVE WITH ALREADY RUINED SCREWS.



S2 Mo-V

Art.	€	Size
D882/1075	€ 3,75	PH 1 x 75 mm
D882/2100	€ 4,83	PH 2 x 100 mm
D882/3150	€ 5,50	PH 3 x 150 mm

D882/2038

CAT 42 € 3,33

CROSS SCREWDRIVER PH WITH DIAMOND TIP

WITH BLACK BLADE AND TRICOMPONENT HANDLE MADE OF HIGHLY ELASTIC TPR RESIN AND OIL-RESISTANT POLYPROPYLENE MATERIAL. THE DIAMOND TIP ALLOWS A PERFECT GRIP, AVOIDING TO RUIN THE HEAD OF THE SCREW. THIS TYPE OF TIP IS ALSO VERY EFFECTIVE WITH ALREADY RUINED SCREWS.



S2 Mo-V

Size	€
PH 2 x 38 mm	€ 3,33

D885-

CAT 42

CROSS SCREWDRIVER PZ WITH DIAMOND TIP

WITH BLACK BLADE AND TRICOMPONENT HANDLE MADE OF HIGHLY ELASTIC TPR RESIN AND OIL-RESISTANT POLYPROPYLENE MATERIAL. THE DIAMOND TIP ALLOWS A PERFECT GRIP, AVOIDING TO RUIN THE HEAD OF THE SCREW. THIS TYPE OF TIP IS ALSO VERY EFFECTIVE WITH ALREADY RUINED SCREWS.



S2 Mo-V

Art.	€	Size
D885/1075	€ 3,75	PZ 1 x 75 mm
D885/2100	€ 4,75	PZ 2 x 100 mm
D885/3150	€ 5,50	PH 3 x 150 mm

D885/2038

CAT 42 € 3,25

CROSS SCREWDRIVER PZ WITH DIAMOND TIP

WITH BLACK BLADE AND TRICOMPONENT HANDLE MADE OF HIGHLY ELASTIC TPR RESIN AND OIL-RESISTANT POLYPROPYLENE MATERIAL. THE DIAMOND TIP ALLOWS A PERFECT GRIP, AVOIDING TO RUIN THE HEAD OF THE SCREW. THIS TYPE OF TIP IS ALSO VERY EFFECTIVE WITH ALREADY RUINED SCREWS.



S2 Mo-V

Size	PZ 2 x 38 mm
------	--------------

C883-

ELECTRICIAN SCREWDRIVER, HANGING PACKAGE

SLOTTED, WITH BLACK PHOSPHATIZED MAGNETIC STRAIGHT TIP, HANDLE MADE OF HIGH ELASTIC RESIN TPR AND POLYPROPYLENE MATERIAL OIL RESISTANT

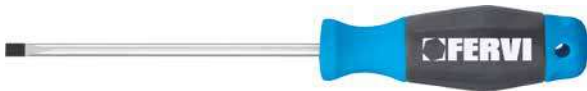

50 Cr-V

Art.	€	Size
C883/3075	€ 1,50	3 x 75 mm
C883/4100	€ 2,21	4 x 100 mm

C884/6038

€ 2,40

SLOTTED SCREWDRIVER, HANGING PACKAGE

WITH BLACK PHOSPHATIZED MAGNETIC TIP, HANDLE MADE OF HIGH ELASTIC RESIN TPR AND POLYPROPYLENE MATERIAL OIL RESISTANT

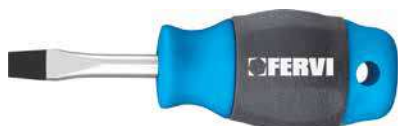

50 Cr-V

Size	6 x 38 mm
------	-----------

D880/006

CAT 42 € 20,70

DIAMOND TIP SCREWDRIVER SET

WITH BLACK BLADE AND TRICOMPONENT HANDLE MADE OF HIGHLY ELASTIC TPR RESIN AND OIL-RESISTANT POLYPROPYLENE MATERIAL. THE DIAMOND TIP ALLOWS A PERFECT GRIP, AVOIDING TO RUIN THE HEAD OF THE SCREW. THIS TYPE OF TIP IS ALSO VERY EFFECTIVE WITH ALREADY RUINED SCREWS.



6 Pcs S2 Mo-V Display box

Sizes Slot	(-) 4 x 100 mm, (-) 5 x 125 mm, (-) 6 x 150 mm
Cross	(+) PH 1 x 75 mm, (+) PH 2 x 100 mm, (+) PH 3 x 150 mm

C884-

SLOTTED SCREWDRIVER, HANGING PACKAGE

WITH BLACK PHOSPHATIZED MAGNETIC TIP, HANDLE MADE OF HIGH ELASTIC RESIN TPR AND POLYPROPYLENE MATERIAL OIL RESISTANT

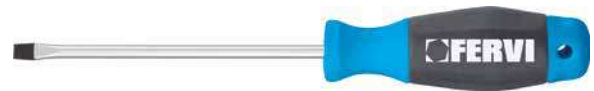

50 Cr-V

Art.	€	Size
C884/3075	€ 1,50	3 x 75 mm
C884/4100	€ 2,31	4 x 100 mm
C884/5125	€ 2,75	5 x 125 mm
C884/6150	€ 3,09	6 x 150 mm
C884/8150	€ 3,60	8 x 150 mm

C882-

CROSS SCREWDRIVER PH, HANGING PACKAGE

WITH BLACK PHOSPHATIZED MAGNETIC TIP, HANDLE MADE OF HIGH ELASTIC RESIN TPR AND POLYPROPYLENE MATERIAL OIL RESISTANT



50 Cr-V

Art.	€	Size
C882/1075	€ 2,75	PH 1 x 75 mm
C882/2100	€ 3,60	PH 2 x 100 mm
C882/3150	€ 3,83	PH 3 x 150 mm



C882/2038

€ 2,40

CROSS SCREWDRIVER PH, HANGING PACKAGE

WITH BLACK PHOSPHATIZED MAGNETIC TIP, HANDLE MADE OF HIGH ELASTIC RESIN TPR AND POLYPROPYLENE MATERIAL OIL RESISTANT



50 Cr-V

Size PH 2 x 38 mm

C885/2038

€ 2,40

CROSS SCREWDRIVER PZ, HANGING PACKAGE

WITH BLACK PHOSPHATIZED MAGNETIC TIP, HANDLE MADE OF HIGH ELASTIC RESIN TPR AND POLYPROPYLENE MATERIAL OIL RESISTANT



50 Cr-V

Size PZ 2 x 38 mm

C885-

CROSS SCREWDRIVER PZ, HANGING PACKAGE

WITH BLACK PHOSPHATIZED MAGNETIC TIP, HANDLE MADE OF HIGH ELASTIC RESIN TPR AND POLYPROPYLENE MATERIAL OIL RESISTANT



50 Cr-V

Art.	€	Size
C885/1075	€ 2,75	PZ 1 x 75 mm
C885/2100	€ 3,60	PZ 2 x 100 mm
C885/3150	€ 3,83	PZ 3 x 150 mm

C880/006

€ 14,00

SCREWDRIVER SET

WITH BLACK PHOSPHATIZED MAGNETIC TIP, HANDLE MADE OF HIGH ELASTIC RESIN TPR AND POLYPROPYLENE MATERIAL OIL RESISTANT.



6 Pcs 50 Cr-V Display box

Sizes Slot	Cross
(-) 4 x 100 mm, (-) 5 x 125 mm, (-) 6 x 150 mm	(+) PH 1 x 75 mm, (+) PH 2 x 100 mm, (+) PH 3 x 150 mm

0887

€ 31,30

EXTRA LONG INTERCHANGEABLE SCREWDRIVER SET

9 PCS DOUBLE ENDED BLADES, WITH TAMPARED TORX AND TAMPARED SECURITY TOX WITH 5 LOBES



Mo-V

Tamper proof tee star	T10 - T15 - T20 - T25 - T27 - T30 - T40
Tampered security Torx	TS10 - TS15 - TS20 - TS25 - TS27 - TS30 - TS40
Slotted	4 - 5 mm
Length	300 mm

0633

€ 13,10

SCREWDRIVER SET

COLOR BOX



6 Pcs Cr-Mo

Sizes Slot	Cross
(-) 5,0x1,0x75 mm, (-) 6,0x1,2x100 mm, (-) 6,0x1,2x125 mm, (-) 8,0x1,2x150 mm	(+) PH 1x5x75 mm, (+) PH 2x6x100 mm

0634

€ 10,30

SCREWDRIVER SET



6 Pcs Cr-Mo

Sizes Slot	(-) 4x0,8x75 mm, (-) 5,5x1,0x100 mm, (-) 6,5x1,2x150 mm
Cross	(+) PH 0x3x75 mm, (+) PH 1x5x100 mm, (+) PH 2x6x125 mm

C183-

INSULATED SLOT SCREWDRIVER

WITH BLACK PHOSPHATIZED MAGNETIC TIP AND POLYPROPYLENE MATERIAL OIL RESISTANT BI-COLOR HANDLE



Mo-V 1000 V IEC 60900

Art.	€	Size	Total length
C183/25075	€ 2,50	0.4 x 2.5 x 75 mm	175 mm
C183/30100	€ 3,25	0.6 x 3 x 100 mm	200 mm
C183/40100	€ 3,25	0.8 x 4 x 100 mm	200 mm
C183/55125	€ 3,50	1 x 5.5 x 125 mm	230 mm
C183/65150	€ 4,58	1.2 x 6.5 x 150 mm	260 mm
C183/80175	€ 6,10	1.6 x 8 x 175 mm	290 mm

0880/307

€ 16,80

SCREWDRIVER SET



7 Pcs Mo-V

Slotted	(-) 3,0x0,5x75 mm, (-) 4,0x0,8x100 mm, (-) 5,5x1,0x125 mm, (-) 6,5x1,2x150 mm, (-) 8,0x1,2x150 mm
Cross	(+) PH 1x80 mm, (+) PH 2x100 mm

C182-

INSULATED CROSS SCREWDRIVER

MAGNETIC TIP



Mo-V 1000 V IEC 60900

Art.	€	Size	Total length
C182/0060	€ 2,50	PH0 x 3 x 60 mm	160 mm
C182/1080	€ 3,25	PH1 x 4.5 x 80 mm	185 mm
C182/2100	€ 3,83	PH2 x 6 x 100 mm	210 mm
C182/3150	€ 6,30	PH3 x 8 x 150 mm	265 mm

C180/006

€ 18,80

INSULATED SCREWDRIVER SET

WITH BLACK PHOSPHATIZED MAGNETIC TIP AND POLYPROPYLENE MATERIAL OIL RESISTANT BI-COLOR HANDLE



Mo-V 1000 V IEC 60900

6 Pcs Mo-V 1000 V IEC 60900 Display box

Sizes Slot	(-) 0,6 x 3 x 100 mm, (-) 0,8 x 4 x 100 mm, (-) 1 x 5,5 x 125 mm
Cross	(+) PH 0 x 3 x 60 mm, (+) PH 1 x 4,5 x 80 mm, (+) PH 2 x 6 x 100 mm

0881/008

€ 14,00

SCREWDRIVER TORX SET



8 Pcs Mo-V

Tea star	T 7x60 - T 8x60 - T 9x60 - T 10x80 - T 15x80 - T 20x100 - T 25x100 - T 30x115 mm
----------	--

0355

€ 16,30

ELECTRICIAN'S SCREWDRIVER



7 Pcs Cr-Mo

Sizes Slot (-) 0,4x2,5x85 mm, (-) 0,8x4,0x100 mm, (-) 1,0x5,5x125 mm, (-) 1,2x6,5x150 mm
Cross (+) PH 0x75 mm, (+) PH 1x100 mm, (+) PH 2x100 mm

P883-

CAT 42

SLOT PRECISION SCREWDRIVER

WITH BURNISHED MAGNETIC TIP, HANDLE IN TWO-COMPONENT MATERIAL WITH FREE END PART TO ROTATE FOR A PERFECT GRIP



Cr-V Phosphated

Art.	€	Size	L1	L
P883/1250	€ 2,33	1,2 mm	50 mm	140 mm
P883/1650	€ 2,33	1,6 mm	50 mm	140 mm
P883/1850	€ 2,33	1,8 mm	50 mm	140 mm
P883/2050	€ 2,33	2,0 mm	50 mm	140 mm
P883/2450	€ 2,33	2,4 mm	50 mm	140 mm
P883/3050	€ 2,33	3,0 mm	50 mm	140 mm
P883/3550	€ 2,33	3,5 mm	50 mm	140 mm
P883/4050	€ 2,33	4,0 mm	50 mm	140 mm

0083

€ 9,80

IMPACT DRIVER

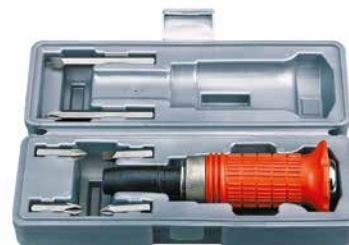

Overall sizes 165x42 mm
Bits 6
Shank 5/16"

P882-

CAT 42

PHILLIPS PRECISION SCREWDRIVER

WITH BURNISHED MAGNETIC TIP, HANDLE IN TWO-COMPONENT MATERIAL WITH FREE END PART TO ROTATE FOR A PERFECT GRIP



Cr-V Phosphated

Art.	€	Size	L1	L
P882/0150	€ 2,33	PH 1	50 mm	140 mm
P882/1050	€ 2,33	PH 0	50 mm	140 mm
P882/2050	€ 2,33	PH 00	50 mm	140 mm

P881-

CAT 42

TORX PRECISION SCREWDRIVER

WITH BURNISHED MAGNETIC TIP, HANDLE IN TWO-COMPONENT MATERIAL WITH FREE END PART TO ROTATE FOR A PERFECT GRIP



Cr-V Phosphated

Art.	€	Size	L1	L
P881/0550	€ 2,33	T5 mm	50 mm	140 mm
P881/0650	€ 2,33	T6 mm	50 mm	140 mm
P881/0750	€ 2,33	T7 mm	50 mm	140 mm
P881/0850	€ 2,33	T8 mm	50 mm	140 mm
P881/0950	€ 2,33	T9 mm	50 mm	140 mm
P881/1050	€ 2,33	T10 mm	50 mm	140 mm
P881/1550	€ 2,33	T15 mm	50 mm	140 mm

P886-

CAT 42

HEXAGONAL PRECISION SCREWDRIVER

WITH BURNISHED MAGNETIC TIP, HANDLE IN TWO-COMPONENT MATERIAL WITH FREE END PART TO ROTATE FOR A PERFECT GRIP



Cr-V Phosphated

Art.	€	Size	L1	L
P886/1350	€ 2,33	1,3 mm	50 mm	140 mm
P886/1550	€ 2,33	1,5 mm	50 mm	140 mm
P886/2050	€ 2,33	2,0 mm	50 mm	140 mm
P886/2550	€ 2,33	2,5 mm	50 mm	140 mm
P886/3050	€ 2,33	3,0 mm	50 mm	140 mm

P880/06S

CAT 42 € 12,90

PRECISION SCREWDRIVER SERIES

WITH BURNISHED MAGNETIC TIP, HANDLE IN TWO-COMPONENT MATERIAL WITH FREE END PART TO ROTATE FOR A PERFECT GRIP



6 Cr-V Phosphated Display box

Slotted 1.2 x 50 mm, 2.0 x 50 mm, 3.0 x 50 mm
Cross PH 00 x 50 mm, PH 0 x 50 mm, PH 1 x 50 mm
Packing dimensions 140 x 185 x 24.5h mm
Weight 0.23 kg

P881/06S

CAT 42 € 12,90

TORX PRECISION SCREWDRIVER SERIES

WITH BURNISHED MAGNETIC TIP, HANDLE IN TWO-COMPONENT MATERIAL WITH FREE END PART TO ROTATE FOR A PERFECT GRIP



6 Cr-V Phosphated Display box

Tee star T5 x 50 mm, T6 x 50 mm, T7 x 50 mm, T8 x 50 mm, T9 x 50 mm, T10
Packing dimensions 140 x 185 x 24.5h mm
Weight 0.23 kg

0244 € 11,30
TORX SCREWDRIVER SET



7 Pcs Cr-Mo-V Blister

Sizes T4 - T5 - T6 - T7 - T8 - T9 - T10
 Total length 137 mm

0245 € 9,30
PRECISION SCREWDRIVER SET



6 Pcs Cr-Mo-V Blister

Cross 00x50 - 0x50 mm
 Slotted 1,5x50 - 2x50 - 2,5x50 - 3x50 mm

0207 € 12,50
DOUBLE HEAD SCREWDRIVER BIT SET



9 Pcs Cr-V

Blade length 110 mm
 Handle length 170 mm

0829 € 5,20
PRECISION SCREWDRIVER AND SPANNER SET
 SUPPLIED IN PLASTIC BOX



16 Pcs

0082 € 1,28
PRECISION SCREWDRIVER SET



6 Pcs Blister

Slot 4 Pcs 4 Pcs 1,4x20 mm - 2x23 mm - 2,4x24 mm - 3x27 mm
 Cross 2 Pcs 2 Pcs PH 1x30 mm - PH 0x25 mm

0466/DM € 1,67
SCREWDRIVERS MAGNETIZER/DEMAGNETIZER



ABS Double blister

Dimensions 52 x 50 x 28.5 mm

0888 € 18,70
1/4" L-SHAPED DRIVER
 BITS INSIDE THE HANDLE



PIF1 € 7,10
FLEXIBLE NUT DRIVER
 1/4"



Hanging package

L 265 mm
 L1 150 mm
 L2 9,5 mm
 L3 115 mm
 A 10 mm
 B 11,8 mm

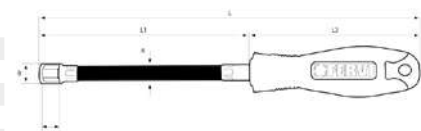

0304

€ 6,00

1/4 SHANK MAGNETIC HANDLE



Shank	1/4"
-------	------

0548

€ 10,80

STUBBY RATCHET SCREWDRIVERS

72 TEETH, WITH ONE BIT, TO USE FOR TIGHT AND LOOSE IN REDUCED SPACE



Blister

Shank	1/4"
Dimensions	ø 29 x 60 mm
Weight	8 g

0547

€ 11,70

RATCHET BIT HOLDER

72 TEETH, WITH 3 BITS, MODULAR TYPE TO USE FOR TIGHT AND LOOSE IN REDUCED SPACE, HANDLE WITH 1/4" DR.



Blister

Shank	1/4"
Dimensions	ø 24 x 80 mm
Handle length	80 mm
Bits	PH: 1 - 2
Slotted bits	6 mm
Weight	25 g

FINGER RATCHET SCREWDRIVERS

72 TEETH, WITH 5 BITS, TO USE FOR TIGHT AND LOOSE IN REDUCED SPACE



Blister

Shank	1/4"
Dimensions	ø 45 x 30 mm
Weight	10 g
Bits	PH: 1 - 2 - 3
Slotted bits	5,5 mm 7 mm

0406

€ 36,10

QUICK CHANGE 6 POINT BIT HOLDER SET



12 Pcs Cr-V Display box

Shank	1/4"
Length	60 mm
Weight	25 g

0407

€ 3,33

BIT HOLDER

STRAIGHT AND 90°, WITH 7 HEX BITS, 1/4" DR., EASY TO USE IN SMALL SPACES



Blister

Shank	1/4"
Length	105 mm
Phillips	1 - 2
Pozi-driv	1 - 2
Slotted	2 - 3 - 4 mm
Weight	100 g

0089

€ 1,55

BIT SET



7 Pcs Blister

Magnetic insert holder	1/4"
Phillips	1 - 2
Pozi-driv	1 - 2
Slotted	4 - 6 mm

0358

SCREWDRIVER BIT AND SOCKET SET

CAT 42 € 26,70

📦 122 Pcs 🔩 Cr-V

Shank	1/4"
Bits	
Phillips	0 - 1 - 2 (x5 Pz/Pcs) - 3
Pozi-driv	0 - 1 - 2 (x5 Pz/Pcs) - 3
Slotted	3 - 4 - 4,5 - 5 - 5,5 - 6 - 6,5 - 7 - 8 mm
Spanner	4 - 6 - 8 - 10
Tee star	8 - 10 - 15 - 20 - 25 - 27 - 30 - 40 - 45
Tripley	1 - 2 - 3 - 4
Tamper proof tee star	8 - 10 - 15 - 20 - 25 - 27 - 30 - 35 - 40
Tee cross	6 - 8 - 10
Metric hex	1,5 - 2 - 2,5 - 3 - 4 - 5 - 5,5 - 6 - 8 mm
Square	0 - 1 - 2 - 3
Inch hex	1/16 - 5/64 - 3/32 - 7/64 - 1/8 - 9/64 - 5/32 - 3/16 - 7/32 - 1/4
Spline	M5 - M6 - M8
Hex tamper proof	2 - 2,5 - 3 - 4 - 5 - 6 - 5/64 - 3/32 - 7/64 - 1/8 - 9/64 - 5/32
Clutch	1 - 2 - 3
Male adapter 1/4" Dr. and 1/4" hex	25 mm
Male adapter 1/4" Dr. and 1/4" hex	50 mm
"Y" adapter	1 Pcs
Bit holder	1 Pcs

WITH DIFFERENT SHAPE AND SIZE,
SUPPLIED IN PLASTIC CASE



Magnetic bit holder	60 mm
Bit driver	1 Pcs
Nut bit driver	4 - 5 - 6 - 7 - 8 - 9 - 10 - 11 - 12 - 13 - 5/32 - 3/13 - 7/32 - 1/4 - 9/32 - 5/16 - 11/32 - 3/8 - 7/16 - 1/2 mm

0086

€ 5,80

MAGNETIC SCREWDRIVER WITH 6 BITS



📦 7 Pcs 📦 Blister

0626L

€ 17,90

LONG BIT SET

WITH MAGNETIC HOLDER



📦 33 Pcs 🔩 Mo-V 📦 Blister

Shank	1/4"
Length	50 mm
Bits	
Tamper proof tee star	T7 - T8 - T10 - T15 - T20 - T25 - T30 - T35 - T40
Hex tamper proof	6 - 5 - 4 - 3 - 2,5 - 2 mm
Hex tamper proof	5/32 - 9/64 - 1/8 - 7/64 - 3/32 - 5/64
Spanner	4 - 6 - 8 - 10
Tee cross	6 - 8 - 10
Tri-wing	1 - 2 - 3 - 4

0626

€ 8,10

BIT SET



📦 33 Pcs 🔩 Mo-V 📦 Blister

Shank	1/4"
Bits	
Tee star	T7 - T8 - T10 - T15 - T20 - T25 - T30 - T35 - T40
Hexagonal	
Metric	6 - 5 - 4 - 3 - 2,5 - 2 mm
Inch	5/32 - 9/64 - 1/8 - 7/64 - 3/32 - 5/64
Spanner	4 - 6 - 8 - 10
Tee cross	6 - 8 - 10
Tri-wing	1 - 2 - 3 - 4

0484

€ 35,80

RIBE BITS SET

3/8" DR. WITH A LENGHT OF 30 AND 100 mm



📦 22 Pcs 🔩 Cr-Mo

Bit holder	DR. 3/8" x 29 mm - DR. 1/2" x 38 mm
Bits	Ribe 3/8" x 30 mm: M5 - M6 - M7 - M8 - M9 - M10 - M11 - M12 - M13
Bits	Ribe 3/8" x 100 mm: M5 - M6 - M7 - M8 - M9 - M10 - M10.3 - M11 - M12 - M13 - M14
Blow mould case	230 x 145 x 50 mm
Weight	0,93 kg



0403

€ 14,50

HEX BIT AND SOCKET SET

COMPOSED OF 18 NICHEL COATED BITS MADE OF S2 STEEL, 6 SOCKETS, 1 SOCKET ADAPTER AND 1 RATCHET SCREWDRIVER BIT HOLDER



26 Pcs Mo-V & Cr-V Blister

Shank	1/4"
Ratchet bit handle	1
Magnetic bit holder	1
Socket	25 mm
Socket	5 - 6 - 7 - 8 - 9 - 10 mm
Slotted	3 - 4 - 5 - 6 - 7 mm
Phillips	0 - 1 - 2 - 3
Pozi-driv	0 - 1 - 2 - 3
Square bits	S0 - S1 - S2 - S3
Weight	355 g

0404

€ 12,70

HEX BIT AND SOCKET SET

WITH NICHEL COATED BITS MADE OF S2 STEEL, SOCKETS MADE OF CR-V STEEL AND QUICK CHANGE BIT HOLDER



35 Pcs Mo-V & Cr-V Blister

Shank	1/4"
Socket	25 mm
Magnetic insert holder	1
Socket holder extension	1
Socket	5 - 6 - 7 - 8 - 9 - 10 - 11 - 12 mm
Slotted	3 - 4 - 5 - 5,5 - 6 - 7 mm
Phillips	0 - 1 - 2 - 3
Pozi-driv	0 - 1 - 2 - 3
Square bits	S0 - S1 - S2 - S3
Tee star	T10 - T15 - T20 - T25 - T30 - T40
Weight	395 g

0402

€ 15,00

HEX BIT SET

MADE OF S2 STEEL AND NICHEL COATED, COMPOSED OF 40 BITS AND 1 72T RATCHET HANDLE



41 Pcs Mo-V & Cr-V Blister

Shank	1/4"
Slotted	3 - 4 - 5 - 5,5 - 6 - 7 mm
Phillips	2x0 - 2x1 - 2x2 - 2x3
Pozi-driv	2x0 - 2x1 - 2x2 - 2x3
Square bits	S0 - S1 - S2 - S3
Tee star	T10 - T15 - T20 - T25 - T27 - T30 - T40
Hexagonal	2 - 2,5 - 3 - 4 - 5 - 5,5 - 6mm
Weight	355 g



0104

€ 30,60

3/8" BIT SET AND 3/8"-1/2" SOCKET



40 Pcs Cr-V

1 Socket bit 1/2"	10 mm
1 Socket bit 3/8"	10 mm
7 Hex bits 4-5-6-7-8-10-12 mm	30 mm
7 Hex bits 4-5-6-7-8-10-12 mm	75 mm
5 Bits "XZN" 5-6-8-10-12 mm	30 mm
5 Bits "XZN" 5-6-8-10-12 mm	75 mm
Bits TORX T20-T25-T30-T40-T45-T50-T55	30 mm
Bits TORX T20-T25-T30-T40-T45-T50-T55	75 mm

0640

€ 18,70

BIT SET

SUPPLIED IN PLASTIC CASE

100 Pcs Mo-V

Shank	1/4"
Bits	
Phillips	0 - 1 - 2 (x5 Pz/Pcs) - 3
Pozi-driv	0 - 1 - 2 (x5 Pz/Pcs) - 3
Slotted	3 - 4 - 4,5 - 5 - 5,5 - 6 - 6,5 - 7 - 8 mm
Spanner	4 - 6 - 8 - 10
Tee star	8 - 10 - 15 - 20 - 25 - 27 - 30 - 40 - 45
Tripley	1 - 2 - 3 - 4
Tamper proof tee star	8 - 10 - 15 - 20 - 25 - 27 - 30 - 35 - 40
Tee cross	6 - 8 - 10
Metric hex	1,5 - 2 - 2,5 - 3 - 4 - 5 - 5,5 - 6 - 8 mm
Square	0 - 1 - 2 - 3
Inch hex	1/16 - 5/64 - 3/32 - 7/64 - 1/8 - 9/64 - 5/32 - 3/16 - 7/32 - 1/4
Spline	M5 - M6 - M8
Hex tamper proof	2 - 2,5 - 3 - 4 - 5 - 6 - 5/64 - 3/32 - 7/64 - 1/8 - 9/64 - 5/32
Clutch	1 - 2 - 3



0277

€ 27,50

HEX BIT AND SOCKET SET

WITH BIT HOLDER AND RATCHET HANDLE

58 Pcs Blow mold case

Shank	1/4"
Bits	25 mm
Phillips (25 mm)	1 - 2 - 3
Pozi-driv	1 - 2 - 3
Slotted	3,5 - 4,5 - 5,5 - 6,5 mm
Spanner	4 - 6 - 8
Tee star	10 - 15 - 20 - 25 - 27 - 30 - 40
Tri-wing	1 - 2 - 3 - 4
Tee cross	6 - 8 - 10
Hexagonal	2 - 3 - 4 - 5 - 6 - 8 mm
Square	1 - 2 - 3
Spline	5 - 6 - 8
Clutch	1 - 2 - 3
Hex. sockets	5 - 6 - 7 - 8 - 10 mm
Hex. sockets	3/16 - 1/4 - 9/32 - 5/16 - 3/8
Adapter 1 1/4"	1
"Y" adapter	1
Socket	1
Magnetic bit holder	1
Bit driver	1
Ratchet handle	1/4"



IS25-ESx

HEXAGONAL BITS

1/4" SHANK MILLED INDUSTRIAL BIT INSERTS

PACKING OF 10* PIECES

Mo-V DIN 3126 Phosphated



Art.	€	Size	Length
IS25/ES2	€ 0,46	2 mm	25 mm
IS25/ES25	€ 0,46	2.5 mm	25 mm
IS25/ES3	€ 0,46	3 mm	25 mm
IS25/ES4	€ 0,46	4 mm	25 mm
IS25/ES5	€ 0,46	5 mm	25 mm
IS25/ES6	€ 0,46	6 mm	25 mm
IS25/ES8	€ 0,71	8 mm	25 mm
IS25/ES10	€ 1,13	10 mm	25 mm

IS25-PHxAS

CROSS BITS PH ANTI SLIP

1/4" SHANK MILLED INDUSTRIAL BIT INSERTS

PACKING OF 10* PIECES

Mo-V DIN 3126 Phosphated



Art.	€	Size	Length
IS25/PH1AS	€ 0,50	PH1 mm	25 mm
IS25/PH2AS	€ 0,50	PH2 mm	25 mm
IS25/PH3AS	€ 0,50	PH3 mm	25 mm

IS25-PZxAS

CROSS BITS PZ ANTI SLIP

1/4" SHANK MILLED INDUSTRIAL BIT INSERTS

PACKING OF 10* PIECES

Mo-V DIN 3126 Phosphated



Art.	€	Size	Length
IS25/PZ1AS	€ 0,50	PZ1 mm	25 mm
IS25/PZ2AS	€ 0,50	PZ2 mm	25 mm
IS25/PZ3AS	€ 0,50	PZ3 mm	25 mm

IS25-TXx

TORX BITS

1/4" SHANK MILLED INDUSTRIAL BIT INSERTS

PACKING OF 10* PIECES

Mo-V DIN 3126 Phosphated



Art.	€	Size	Length
IS25/TX10	€ 0,38	T10 mm	25 mm
IS25/TX15	€ 0,38	T15 mm	25 mm
IS25/TX20	€ 0,38	T20 mm	25 mm
IS25/TX25	€ 0,38	T25 mm	25 mm
IS25/TX30	€ 0,38	T30 mm	25 mm
IS25/TX35	€ 0,38	T35 mm	25 mm
IS25/TX40	€ 0,38	T40 mm	25 mm
IS25/TX45	€ 1,00	T45 mm	25 mm
IS25/TX50	€ 1,00	T50 mm	25 mm
IS25/TX55	€ 1,13	T55 mm	25 mm

IS50-PHx

CROSS BITS PH

1/4" SHANK MILLED INDUSTRIAL BIT INSERTS WITH TURN-DOWN BODY

PACKING OF 10* PIECES

Mo-V DIN 3126 Phosphated



Art.	€	Size	Length
IS50/PH1	€ 0,63	PH 1 mm	50 mm
IS50/PH2	€ 0,63	PH 2 mm	50 mm
IS50/PH3	€ 0,63	PH 3 mm	50 mm

IS25-PHx

CROSS BITS PH

1/4" SHANK MILLED INDUSTRIAL BIT INSERTS

PACKING OF 20* PIECES

Mo-V DIN 3126 Phosphated



Art.	€	Size	Length
IS25/PH0	€ 0,31	PH0 mm	25 mm
IS25/PH1	€ 0,31	PH1 mm	25 mm
IS25/PH2	€ 0,31	PH2 mm	25 mm
IS25/PH3	€ 0,31	PH3 mm	25 mm

IS25-PZx

CROSS BITS PZ

1/4" SHANK MILLED INDUSTRIAL BIT INSERTS

PACKING OF 20* PIECES

Mo-V DIN 3126 Phosphated



Art.	€	Size	Length
IS25/PZ1	€ 0,31	PZ1 mm	25 mm
IS25/PZ2	€ 0,31	PZ2 mm	25 mm
IS25/PZ3	€ 0,31	PZ3 mm	25 mm

IS25-TGx

SLOTTED BITS

1/4" SHANK MILLED INDUSTRIAL BIT INSERTS

PACKING OF 10* PIECES

Mo-V DIN 3126 Phosphated



Art.	€	Size	Length
IS25/TG3	€ 0,38	3 x 0.5 mm	25 mm
IS25/TG4	€ 0,38	4 x 0.8 mm	25 mm
IS25/TG5.5	€ 0,38	5.5 x 0.8 mm	25 mm
IS25/TG6	€ 0,38	6 x 1 mm	25 mm
IS25/TG8	€ 0,67	8 x 1.2 mm	25 mm

IS50-ESx

HEXAGONAL BITS

1/4" SHANK MILLED INDUSTRIAL BIT INSERTS WITH TURN-DOWN BODY

PACKING OF 5* PIECES

Mo-V DIN 3126 Phosphated



Art.	€	Size	Length
IS50/ES2	€ 0,96	2 mm	50 mm
IS50/ES25	€ 0,79	2.5 mm	50 mm
IS50/ES3	€ 0,79	3 mm	50 mm
IS50/ES4	€ 0,79	4 mm	50 mm
IS50/ES5	€ 0,79	5 mm	50 mm
IS50/ES6	€ 0,79	6 mm	50 mm
IS50/ES8	€ 1,00	8 mm	50 mm
IS50/ES10	€ 1,00	10 mm	50 mm

IS50-PZx

CROSS BITS PZ

1/4" SHANK MILLED INDUSTRIAL BIT INSERTS WITH TURN-DOWN BODY

PACKING OF 10* PIECES

Mo-V DIN 3126 Phosphated



Art.	€	Size	Length
IS50/PZ1	€ 0,63	PZ1 mm	50 mm
IS50/PZ2	€ 0,63	PZ2 mm	50 mm
IS50/PZ3	€ 0,63	PZ3 mm	50 mm

IS50-TGx

SLOTTED BITS

1/4" SHANK MILLED INDUSTRIAL BIT INSERTS WITH TURN-DOWN BODY

PACKING OF 5* PIECES

Mo-V DIN 3126 Phosphated



Art.	€	Size	Length
IS50/TG3	€ 1,00	3 x 0.5 mm	50 mm
IS50/TG4	€ 1,00	4 x 0.8 mm	50 mm
IS50/TG5.5	€ 1,00	5.5 x 0.8 mm	50 mm
IS50/TG6	€ 1,00	6 x 1 mm	50 mm
IS50/TG8	€ 1,13	8 x 1.2 mm	50 mm

IS50-TXx

TORX BITS

1/4" SHANK MILLED INDUSTRIAL BIT INSERTS WITH TURN-DOWN BODY

PACKING OF 5* PIECES

Mo-V DIN 3126 Phosphated



Art.	€	Size	Length
IS50/TX10	€ 1,13	T10 mm	50 mm
IS50/TX15	€ 1,13	T15 mm	50 mm
IS50/TX20	€ 1,13	T20 mm	50 mm
IS50/TX25	€ 1,13	T25 mm	50 mm
IS50/TX30	€ 1,13	T30 mm	50 mm
IS50/TX35	€ 1,13	T35 mm	50 mm
IS50/TX40	€ 1,13	T40 mm	50 mm

S018

€ 75,00

HAND RIVETER SET

WITH NORMAL RIVETS: 50PCS 2.4 mm - 50PCS 3.2 mm - 50PCS 4 mm - 50PCS 4.8 mm, HAND NUT RIVETER WITH THREAD RIVETS: 50PCS M3 - 50PCS M4 - 25PCS M5 - 25PCS M6 - 20PCS M8, IN TOOL BOX



Blow mold case

Rivets \varnothing 2,4 - 4,8 mm
Nut rivets M3 - M4 - M5 - M6 - M8

0455

€ 82,50

DOUBLE HAND NUT RIVETER

FROM M3 TO M12, WITH 7 NOSEPIECES, PACKED IN BLOW MOULD CASE



Blow mold case

Nosepieces M3 - M4 - M5 - M6 - M8 - M10 - M12
Length 400 mm

0469

€ 45,80

HAND NUT RIVETER

FROM M3 TO M6, WITH 4 NOSEPIECES



Color box

Nosepieces M3 - M4 - M5 - M6
Length 200 mm



0453

€ 37,00

DOUBLE HAND RIVETER

FOR RIVETS FROM 3.2 mm TO 6.4 mm. LONG HANDLES PERMIT TO THE WORKER TO WORK WITHOUT EFFORT UNTIL RIVETS OF 6.4 mm. UNDER THE RIVET UNIT, THE PLASTIC CONTAINER COLLECTS THE USED MANDRELS FOR DISPOSAL EASE



Color box

Rivets \varnothing 3,2 - 4,0 - 4,8 - 6,4 mm
Length 400 mm

0470

€ 15,00

HAND RIVETER WITH MULTI-SIDES BLOCKER

MADE OF STEEL, WITH ROTATING HEAD - 4 POSITIONS



Blister

Rivets 2,4 mm - 3/32", 3,2 mm - 1/8", 4,0 mm - 5/32", 4,8 mm - 3/16"

0058

€ 12,40

10.5" HAND RIVETER SET



Blister

Rivets \varnothing 2,4 + 4,0 mm

0454

€ 41,70

DOUBLE HAND RIVETER WITH ROTATING HEAD

WITH 4 IN 1 ROTATING HEAD 3.2 - 6.4 mm. THE SWIVEL HEAD ALLOWS TO CHANGE BETWEEN RIVET SIZES 3.2MM - 6.4 mm QUICKLY, WITHOUT WRENCHES USAGE. UNDER THE RIVET UNIT, THE PLASTIC CONTAINER COLLECTS THE USED MANDRELS FOR DISPOSAL EASE



Color box

Rivets \varnothing 3,2 - 4,0 - 4,8 - 6,4 mm
Length 400 mm

0789

€ 15,00

HAND RIVETER



Blister

Rivets \varnothing 2,4 + 4,8 mm
Length 255 mm

0124

€ 9,90

10.5" HAND RIVETER



Blister

Rivets \varnothing 2,4 + 4,0 mm

0872/P

€ 55,00

DOUBLE JOINT LONG PLIER SET

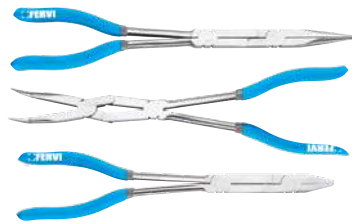

3 Pcs Cr-V Hanging package

Length	335 mm
Length	300 mm
Weight	1,35 kg

0872/PDD

€ 20,60

DOUBLE X LONG REACH PLIER LONG NOSE

WITH PVC HANDLE



Cr-V Hanging package

Length	335 mm
Thickness	10 mm
Weight	390 g

0872/PCD

€ 20,60

DOUBLE X LONG REACH PLIER LONG BENT NOSE 45°

WITH PVC HANDLE



Cr-V Hanging package

Length	335 mm
Thickness	10 mm
Weight	390 g

0872/OPD

€ 21,50

DOUBLE X LONG REACH PLIER

WITH PVC HANDLE, WITH ROUND TIPS AND GRIP NOT INFERIOR TO 8 mm



Cr-V Hanging package

Length	335 mm
Thickness	10 mm
Weight	450 g

0873-U

COMBINATION PLIERS



Cr-V Hanger Satin finished

Art.	€	Length	Thickness	Weight
0873/U6	€ 6,70	160 mm	11 mm	200 g
0873/U7	€ 7,20	180 mm	10,5 mm	260 g
0873/U8	€ 8,10	200 mm	12 mm	330 g

0873-BD

LONG NOSE PLIERS



Cr-V Hanger Satin finished

Art.	€	Length	Thickness	Weight
0873/BD6	€ 5,80	160 mm	9 mm	150 g
0873/BD8	€ 7,30	200 mm	10 mm	250 g

0873-BC

BENT NOSE PLIERS 45°



Cr-V Hanger

Art.	€	Length	Thickness	Weight
0873/BC6	€ 5,80	160 mm	9 mm	150 g
0873/BC8	€ 7,30	200 mm	10 mm	250 g

0873/TL

€ 6,30

DIAGONAL SIDE CUTTING NIPPERS



Cr-V Hanging package

Length	160 mm
Thickness	9 mm
Weight	210 g



0873/TF

€ 8,00

END CUTTING NIPPERS

SATIN FINISHED



Cr-V Hanging package

Length	160 mm
Thickness	11 mm
Weight	220 g

0020/1

€ 4,33

EXTRA LONG NOSE MINI PLIERS

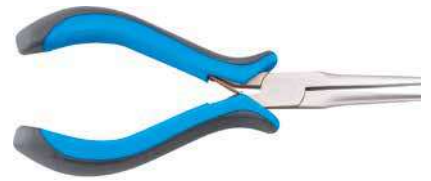

Blister

Length	150 mm
--------	--------

0020/2

€ 3,23

BENT NOSE PLIERS



Blister

Length	125 mm
--------	--------

0020/3

€ 3,52

FLAT NOSE MINI PLIERS



Blister

Length	125 mm
--------	--------

0020/4

€ 3,45

LONG NOSE MINI PLIERS



Blister

Length	125 mm
--------	--------

0020/5

€ 3,88

END CUTTING NIPPERS

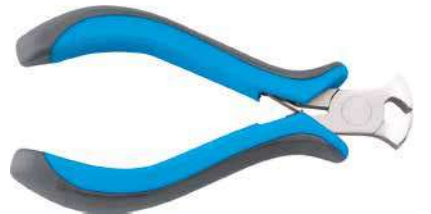

Blister

Length	110 mm
--------	--------

0020/6

€ 3,75

DIAGONAL SIDE CUTTING NIPPERS



Blister

Length	110 mm
--------	--------

0020

€ 13,30

FINE POLISHED MINI PLIER SET



5 Pcs Blister

Length	110 ÷ 125 mm
--------	--------------



08X

COMBINATION PLIERS



Hanger Molybdenum mat

Art.	€	Length	Thickness	Weight
0810	€ 4,67	160 mm	11 mm	250 g
0811	€ 5,70	180 mm	11 mm	290 g
0850	€ 6,30	200 mm	13 mm	410 g

08XX

LONG NOSE PLIERS



Hanger Molybdenum mat

Art.	€	Length	Thickness	Weight
0812	€ 4,75	160 mm	10 mm	160 g
0851	€ 6,00	200 mm	11 mm	260 g

0813

€ 5,10

BENT NOSE PLIERS 45°



Hanging package Molybdenum mat

Length	160 mm
Thickness	10 mm
Weight	160 g

0814

€ 4,33

DIAGONAL SIDE CUTTING NIPPERS



Hanging package Molybdenum mat

Length	160 mm
Thickness	10 mm
Weight	180 g

0841

€ 18,30

RATCHET CRIMPING TOOL

WITH RELEASE LEVER



Blister

For insulated terminals	Ø 0,8 ÷ 3,5 mm / 0,25 ÷ 6 mm ² AWG 22-10
Length	230 mm
Thickness	12 mm

0843

€ 19,00

RATCHET CRIMPING TOOL

WITH RELEASE LEVER



Blister

For barrel open terminals	Ø 1 ÷ 3,5 mm / 0,5 ÷ 6 mm ² AWG 20-10
Length	230 mm
Thickness	12 mm

0847

€ 59,60

CRIMPING PLIERS FOR END SLEEVES TERMINALS

WITH RELEASE LEVER

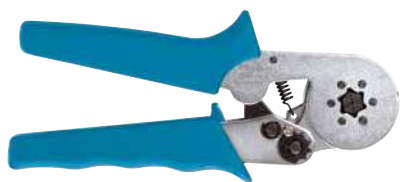

Blister

Terminals	0,25 ÷ 6 mm ² AWG 23-10
Length	175 mm
Thickness	12 mm

0628

€ 14,40

MODULAR PLUG CRIMPING TOOL

WITH RELEASE KNOB



Blister

Electric plugs	RJ-11 (6P4C); RJ-12 (6P6C); RJ-45 (8P8C)
----------------	--



0826

€ 23,30

CRIMPING PLIER AND WIRE STRIPPER

CAR AND COMPUTER CRIMPING PLIER WITH WIRE STRIPPER FOR THIN WIRE



Blister

Length	215 mm
Terminals	AWG 30-26 - AWG 24-20 - AWG 18-14
Cutting capacity	ø 0,25 - 0,3 - 0,4 - 0,5 - 0,65 - 0,8 - 1,0 mm AWG30 - AWG28 - AWG26 - AWG24 - AWG22 - AWG20 - AWG18

0122

€ 7,80

UNIVERSAL CRIMPING PLIER SET

WITH INSULATED TERMINALS



Blister

Length	220 mm
--------	--------

024X

CIRCLIP PLIERS

hanger

Art.	€	Pliers type	Circlips	Length
0246	€ 9,10	External straight nose A2	Ø 19 ÷ 60 mm	175 mm
0248	€ 9,10	Internal straight nose J2	Ø 19 ÷ 60 mm	175 mm
0636	€ 7,70	External straight nose A1	Ø 10 ÷ 25 mm	150 mm
0638	€ 7,70	Internal straight nose J1	Ø 8 ÷ 25 mm	150 mm



063X

CIRCLIP PLIERS

BENT NOSE

Hanger

Art.	€	Pliers type	Circlips	Length
0247	€ 9,10	External curved nose A21	Ø 19 ÷ 60 mm	175 mm
0249	€ 9,10	Internal curved nose J21	Ø 19 ÷ 60 mm	175 mm
0637	€ 7,70	External curved nose A11	Ø 10 ÷ 25 mm	150 mm
0639	€ 7,70	Internal curved nose J11	Ø 8 ÷ 25 mm	150 mm



0136

€ 19,20

NYLON CLAMP SET

AUTOMOTIVE HOSE



Blister

Length	158 - 185 - 254 mm
Max hose ø	10 - 15 - 24 mm

0603

€ 81,70

AUTO REPAIRING PLIERS SET

FOR CARS ZIP TIES



Blow mold case

0118

€ 4,00

WATER PUMP PLIERS

6 POSITIONS



Hanging package

Length 240 mm

0831-

WATER PUMP PLIERS

7 POSITIONS DOUBLE RACK, WITH HANGER



Cr-V DIN ISO 8976/C

Art.	€	Length
0831/175	€ 6,50	175 mm
0831/250	€ 7,70	250 mm
0831/300	€ 9,40	300 mm

0834

€ 4,67

TOWER PINCERS



DIN ISO 9242 Hanging package

Length 220 mm

0206

€ 5,50

CARPENTER PINCER

CARPENTER PINCER



Hanging package

Length 200 mm

0121

€ 20,00

LOCKING L-GRIP CLAMP



Color box

Length 230 mm
Adjustable 0 ÷ 165 mm

0120

€ 7,80

4 POSITIONS ADJUSTABLE LOCK WRENCH



Color box

Length 230 mm
Opening 18 - 39 - 43 mm

0119

€ 5,70

ADJUSTABLE LOCK WRENCH



Color box

Length 220 mm

0379

€ 9,80

FOUR JAWS ADJUSTABLE LOCK WRENCH



Color box

Length 225 mm



0368-

AUTOMATIC LOCK WRENCH



Cr-V

Art.	€	Length	Weight
0368/7	€ 22,10	160 mm	160 g
0368/10	€ 28,20	230 mm	260 g

0373-

'C' NOSE AUTOMATIC LOCK WRENCH



Cr-V

Art.	€	Length	Opening	Weight
0373/9	€ 27,50	210 mm	65 mm	160 g
0373/11	€ 33,30	300 mm	95 mm	260 g

0225-

45° BENT NOSE PIPE WRENCH



Cr-V

Art.	€	Dimensions	Max Opening
0225/340	€ 16,10	340 mm - 1"	46 mm
0225/440	€ 24,20	440 mm - 1,5"	62 mm
0225/580	€ 30,00	580 mm - 2"	78 mm
0225/700	€ 40,80	700 mm - 3"	100 mm

0370-

LONG NOSE AUTOMATIC LOCK WRENCH



Cr-V

Art.	€	Length	Weight
0370/8	€ 24,00	200 mm	160 g
0370/11	€ 34,30	275 mm	260 g

0130-

HEAVY DUTY PIPE WRENCH



Art.	€	Dimensions	Max Opening
0130/350	€ 12,70	350 mm - 14"	50 mm
0130/600	€ 19,60	600 mm - 24"	90 mm

0227-

90° BENT NOSE PIPE WRENCH



Cr-V

Art.	€	Overall sizes	Max Opening
0227/340	€ 16,10	340 mm - 1"	41 mm
0227/440	€ 23,00	440 mm - 1,5"	62 mm
0227/580	€ 33,30	580 mm - 2"	75 mm
0227/700	€ 45,30	700 mm - 3"	100 mm

0511

€ 30,40

SLEDGE HAMMER

WITH SAFETY FIBERGLASS PLASTIC HANDLE WITH BLACK RUBBER GRIP



Length	820 mm
Head weight	3,50 kg
Total weight	4,46 kg

0780

€ 8,10

CLA W HAMMER

WITH SAFETY FIBERGLASS PLASTIC HANDLE WITH BLACK RUBBER GRIP



Weight	500 g
--------	-------

0154-

MACHINIST'S HAMMER GERMAN TYPE

WITH WOOD HANDLE



Art.	€	Weight
0154/100DIN	€ 2,28	100 g
0154/200DIN	€ 3,22	200 g
0154/300DIN	€ 3,38	300 g
0154/400DIN	€ 4,42	400 g
0154/500DIN	€ 4,75	500 g
0154/600DIN	€ 5,20	600 g
0154/800DIN	€ 5,80	800 g
0154/1000DIN	€ 8,60	1000 g
0154/1500DIN	€ 9,50	1500 g
0154/2000DIN	€ 12,10	2000 g

0781

€ 10,30

STONING HAMMER

WITH SAFETY FIBERGLASS PLASTIC HANDLE WITH BLACK RUBBER GRIP



DIN 6475

Length	260 mm
Weight	1000 g

0514-

MACHINIST'S HAMMER GERMAN TYPE

WITH SAFETY FIBERGLASS PLASTIC HANDLE WITH BLACK RUBBER GRIP, DIN 1041



DIN 1041

Art.	€	Weight
0514/200	€ 4,33	200 g
0514/300	€ 5,30	300 g
0514/400	€ 6,30	400 g
0514/500	€ 7,60	500 g
0514/1000	€ 11,30	1000 g

0153-

STONING HAMMER



DIN 6475

Art.	€	Weight
0153/800DIN	€ 5,80	800 g
0153/1000DIN	€ 6,40	1000 g
0153/1250DIN	€ 7,80	1250 g
0153/1500DIN	€ 9,10	1500 g



0169-

CLAW HAMMER ITALIAN TYPE

MAGNETIC



Art.	€	Weight
0169/300	€ 5,80	300 g
0169/400	€ 7,00	400 g

0216/400

CHIPPING HAMMER

WITH WOODEN HANDLE



Weight	400 g
Handle length	380 mm

€ 6,70

0239/400

CHIPPING HAMMER

WITH FIBERGLASS PLASTIC HANDLE WITH BLACK RUBBER GRIP



Weight	400 g
Handle length	380 mm

€ 8,30

0148/500

RUBBER MALLET



Weight	500 g
Head	ø 65 mm

€ 3,47

0243-

TWO WAY MALLET



Art.	€	Weight	Head
0243/30	€ 4,58	350 g	ø 30 mm
0243/40	€ 6,40	500 g	ø 40 mm

0794-

TWO WAY RUBBER MALLET

EQUIPPED OF FIBERGLASS HANDLE



Art.	€	Weight	Head
0794/350	€ 4,67	350 g	ø 55 mm
0794/450	€ 6,50	500 g	ø 58 mm

0808-

MALLET

ALUMINIUM WITH ANATOMIC HANDLE AND POLYETHYLENE HEADS



Art.	€	Head
0808/35	€ 15,30	ø 35 mm
0808/60	€ 36,40	ø 60 mm

033X

DEAD BLOW RUBBER MALLET



Art.	€	Weight	Head
0336	€ 10,00	500 g	ø 45 mm
0337	€ 11,30	900 g	ø 50 mm



0839-

DEAD BLOW Mallet

NYLON, SPARE PART HEAD



Art.	€	Head	Weight
0839/40	€ 42,20	ø 40 mm	0,75 kg
0839/50	€ 49,10	ø 50 mm	1,1 kg
0839/60	€ 55,00	ø 60 mm	1,5 kg

0839-XT

SPARE PART HEAD

FOR DEAD BLOW Mallet 0839-



Art.	€	Head
0839/40T	€ 9,90	ø 40 mm
0839/50T	€ 9,90	ø 50 mm
0839/60T	€ 14,50	ø 60 mm

072X

DEAD BLOW Mallet

NYLON, WITH MONOBLOCK BODY MADE OF SHOCK RESISTANT ALUMINIUM ALLOY. ANATOMIC HANDLE MADE OF NON-SLIDING WOOD. INTERNAL MASS COMPOSED OF LEAD BALLS. CHANGEABLE HEADS MADE OF NON-DEFORMABLE NYLON.



Art.	€	Head	Weight
0726	€ 59,30	ø 40 mm	0,55 kg
0727	€ 69,40	ø 50 mm	0,9 kg
0728	€ 75,60	ø 60 mm	1,1 kg

073X

SPARE PART HEAD

FOR DEAD BLOW Mallet 072x



Art.	€	Head
0729	€ 17,60	ø 40 mm
0730	€ 21,00	ø 50 mm
0731	€ 27,20	ø 60 mm

G009

SAFE SPRING HOOK

TO PUT IN SAFETY TOOLS WHEN WORKING ON LADDERS OR SCAFFOLDS

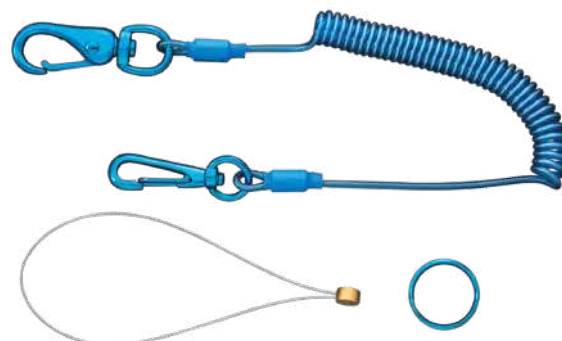

€ 13,30

Blister

Capacity	5 kg
Length	430 ÷ 1600 mm
Weight	75 g



B006-

CENTER PUNCH

WITH OCTAGONAL BODY



Cr-Mo Hanger

Art.	€	Sizes
B006/4	€ 3,33	4 x 120 mm
B006/5	€ 4,58	5 x 150 mm

S022-

CHISEL FOR METAL

EXTRA FLAT



Cr-Mo

Art.	€	Overall sizes
S022/18	€ 6,70	18 x 150 mm
S022/21	€ 9,20	21 x 200 mm
S022/25	€ 12,50	25 x 250 mm
S022/26	€ 12,10	26 x 240 mm

C015

€ 50,70

DRIFT PIN SET

WITH OCTAGONAL BODY AND HAND GUARD



7 Pcs Cr-Mo Color box

Sizes	ø 2 - 3 - 4 - 5 - 6 - 7 - 8 mm
-------	--------------------------------

C012-

DRIFT PIN

WITH OCTAGONAL BODY



Cr-Mo

Art.	€	Overall sizes
C012/02	€ 3,83	ø 2 x 150 mm
C012/03	€ 3,83	ø 3 x 150 mm
C012/04	€ 3,83	ø 4 x 150 mm
C012/05	€ 4,33	ø 5 x 150 mm
C012/06	€ 4,75	ø 6 x 150 mm
C012/08	€ 5,20	ø 8 x 150 mm

C015-

DRIFT PIN

WITH OCTAGONAL BODY AND HAND GUARD



Cr-Mo Hanger

Art.	€	Overall sizes
C015/2	€ 6,00	ø 2 x 8 x 140 mm
C015/3	€ 6,30	ø 3 x 8 x 150 mm
C015/4	€ 6,80	ø 4 x 10 x 180 mm
C015/5	€ 7,10	ø 5 x 10 x 220 mm
C015/6	€ 8,30	ø 6 x 12 x 210 mm
C015/7	€ 8,30	ø 7 x 12 x 210 mm
C015/8	€ 8,60	ø 8 x 12 x 220 mm

0126

€ 11,70

DRIFT PIN SET WITH PLASTIC HOLDER



6 Pcs Cr-V Blister

Overall sizes	ø 3-4-5-6-8-10 mm
Length	150 mm

0127

€ 12,20

MECHANIC CHISEL, PIN PUNCH AND CENTER PUNCH SET WITH PLASTIC HOLDER



6 Pcs Cr-V Blister

Length 120 - 150 mm

0152

€ 4,67

STONING CHISEL SET WITH HAND GUARD



2 Pcs Color box

Overall sizes 16 x 250 mm

0259

€ 3,33

POINT COLD CHISEL WITH HAND GUARD



Overall sizes 16 x 300 mm

0391

€ 26,00

MECHANIC CHISEL, PIN PUNCH AND CENTER PUNCH SET WITH HAND GUARD



6 Pcs Cr-V Hanging package

Chisel	10 x 135 mm, 13 x 150 mm, 16 x 160 mm
Center punches	04 x 130 mm
Solid punch	03 x 120 mm
Pin punch	03 x 120 mm

0381

€ 7,00

AUTOMATIC CENTER PUNCH

SPRING



Blister

Length 125 mm

0258

€ 3,47

FLAT POINT COLD CHISEL WITH HAND GUARD



Overall sizes 16 x 300 mm

0396

€ 10,60

CHISEL SET FOR METAL

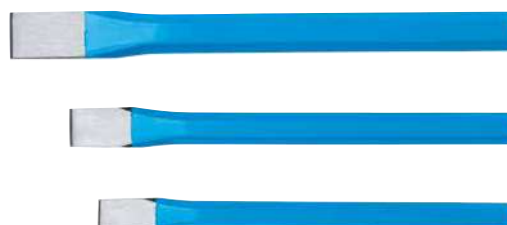

3 Pcs Cr-V Hanging package

Overall sizes 10 x 8 x 140 mm, 13 x 9,5 x 150 mm, 16 x 12 x 170 mm

0300

CHISEL SET FOR WOOD

€ 15,00



4 Pcs Blister

Hardness HRC 58-60
Overall sizes 10-16-20-25 mm

0301-

WOOD CHISEL

HARDNESS HRC 58-60, BLISTER



Art.	€	Overall sizes
0301/06	€ 3,60	6 mm
0301/10	€ 3,60	10 mm
0301/16	€ 4,28	16 mm
0301/20	€ 4,28	18.5 mm
0301/24	€ 5,20	25 mm

0168

WOOD CHISEL SET

€ 8,80



5 Pcs Blister

Hardness HRC 58-60
Sizes 240 x 6-10-16-20-24 mm

0306

CARVING CHISEL SET

€ 50,40



12 Pcs Wooden box

Length 215 mm
Hardness HRC 58-60

0162

WOOD CHISEL SET FOR LATHE

€ 14,80



3 Pcs Blister

Hardness HRC 58-60
Total length 370 mm

0166

IRON PLANER FOR WOOD

€ 15,80



Color box

Planer length 225 mm
Blade width 50 mm

0519

€ 4,58

WOOD RASP SET WITH PLASTIC HANDLE



3 Pcs Hanging package

Overall sizes 200 mm - 8"

0160

€ 14,00

FILE SET FOR METAL WITH ANATOMIC HANDLE



5 Pcs Blister

Overall sizes 200 mm - 8"

0219

€ 4,50

NEEDLE FILE SET



6 Pcs Blister

Total length 180 mm

0214

€ 4,58

ROUND HANDLE NEEDLE FILE SET



12 Pcs Hanging package

Overall sizes Ø 3 x 140 mm

L011

€ 21,50

BENT NOSE DIAMOND NEEDLE FILE SET

TOTAL LENGTH 140 mm



5 Pcs

L012

€ 28,00

DIAMOND NEEDLE FILE SET

TOTAL LENGTH 180 mm



5 Pcs

L013

€ 18,30

DIAMOND NEEDLE FILE SET

TOTAL LENGTH 140 mm



5 Pcs

L012/PIA

€ 7,70

DIAMOND FLAT FILE

180 mm



074X

STEEL FILE

WITH ERGONOMIC PLASTIC HANDLE

PACKING OF 10* PIECES

 Blister



Art.	€	File	Dimensions	Shape
0737/150T2	€ 3,90	Half cut file	150 mm 6 Inch	Rectangular
0737/150T3	€ 3,90	Smooth cut file	150 mm 6 Inch	Rectangular
0737/200T2	€ 4,67	Half cut file	200 mm 8 Inch	Rectangular
0737/200T3	€ 4,67	Smooth cut file	200 mm 8 Inch	Rectangular
0737/250T2	€ 5,70	Half cut file	250 mm 10 Inch	Rectangular
0737/250T3	€ 5,70	Smooth cut file	250 mm 10 Inch	Rectangular
0738/150T2	€ 3,90	Half cut file	150 mm 6 Inch	Triangular
0738/150T3	€ 3,90	Smooth cut file	150 mm 6 Inch	Triangular
0738/200T2	€ 4,67	Half cut file	200 mm 8 Inch	Triangular
0738/200T3	€ 4,67	Smooth cut file	200 mm 8 Inch	Triangular
0738/250T2	€ 5,70	Half cut file	250 mm 10 Inch	Triangular
0738/250T3	€ 5,70	Smooth cut file	250 mm 10 Inch	Triangular
0739/150T2	€ 3,90	Half cut file	150 mm 6 Inch	Half round
0739/150T3	€ 3,90	Smooth cut file	150 mm 6 Inch	Half round
0739/200T2	€ 4,67	Half cut file	200 mm 8 Inch	Half round
0739/200T3	€ 4,67	Smooth cut file	200 mm 8 Inch	Half round
0739/250T2	€ 5,70	Half cut file	250 mm 10 Inch	Half round
0739/250T3	€ 5,70	Smooth cut file	250 mm 10 Inch	Half round
0740/150T2	€ 3,90	Half cut file	150 mm 6 Inch	Round
0740/150T3	€ 3,90	Smooth cut file	150 mm 6 Inch	Round
0740/200T2	€ 4,67	Half cut file	200 mm 8 Inch	Circular
0740/200T3	€ 4,67	Smooth cut file	200 mm 8 Inch	Circular
0740/250T2	€ 5,70	Half cut file	250 mm 10 Inch	Circular
0740/250T3	€ 5,70	Smooth cut file	250 mm 10 Inch	Circular
0741/150T2	€ 3,90	Half cut file	150 mm 6 Inch	Square
0741/150T3	€ 3,90	Smooth cut file	150 mm 6 Inch	Square
0741/200T2	€ 4,67	Half cut file	200 mm 8 Inch	Square
0741/200T3	€ 4,67	Smooth cut file	200 mm 8 Inch	Square
0741/250T2	€ 5,70	Half cut file	250 mm 10 Inch	Square
0741/250T3	€ 5,70	Smooth cut file	250 mm 10 Inch	Square

0742-

ANATOMIC PLASTIC FILE HANDLE



Art.	€	For file
0742/4	€ 1,12	4" - 6"
0742/6	€ 1,12	6" - 10"
0742/10	€ 1,28	10" - 16"

L002-

PRY BAR

WITH SWIVEL GEAR HEAD



 Cr-V  Hanger

Art.	€	Length
L002/200	€ 22,50	200 mm
L002/250	€ 23,30	250 mm



0202

€ 29,30

PRY BAR SET

1 PC 230 mm / 9", 1 PC 300 mm / 12", 1 PC 450 mm / 18", 1 PC 590 mm / 24"



4 Pcs Blister

0192

€ 118,00

HEAVY DUTY PRY BAR SET

1 PC STRAIGHT 910 mm / 36", 1 PC BENT 45° 910 mm / 36", 1PC BENT 60° 610 mm / 24", 1 PC BENT 90° 610 mm / 24"



4 Pcs Cr-V Blow mold case

0198

€ 4,88

POINTED PRY BAR

POINTED PRY BAR

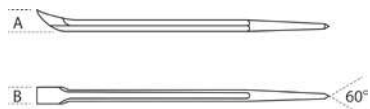

Length	400 mm
A	30 mm
B	23 mm
Weight	0,55 kg

0320

€ 5,30

WRECKING BAR



Total length	600 mm
Hexagon	15,6 mm
Weight	1 kg

0192-

HEAVY DUTY PRY BAR SET



Cr-V

Art.	€	Single bars	Length
0192/24C	€ 22,90	Bent pry bar 45°	610 mm / 24"
0192/24C90	€ 22,90	Bent pry bar 90°	610 mm / 24"
0192/36C	€ 22,90	Bent pry bar 45°	910 mm / 36"
0192/36D	€ 22,90	Straight pry bar	910 mm / 36"

L007

€ 6,00

MOTORCYCLE TYRE LEVER



Box

Dimensions	215 x 16 X 5 mm
Weight	120 g

0267

€ 7,70

TYRE LEVER



Color box

Overall sizes	510 x 26 x 9 mm
Zinc-plated	

0623

€ 4,33

SNAP-OFF UTILITY KNIFE, BLADES INCLUDED

WITH AUTOMATIC LOADING OF THE BLADE



 Blister

Standard blades	3
Blade width	18 mm

0617

€ 2,10

AUTOMATIC SNAP-OFF UTILITY KNIFE BLADES INCLUDED



 Box

Standard blades	3
Blade width	18 mm

0096

€ 2,10

SNAP-OFF UTILITY KNIFE, BLADES INCLUDED



 Box

Standard blades	3
Blade width	18 mm

0627

€ 3,33

SNAP-OFF UTILITY KNIFE BLADES INCLUDED

WITH AUTOMATIC LOADING OF THE BLADE



 Blister

Standard blades	5
Blade width	9 mm

0613

CAT 42 € 1,67

STAINLESS STEEL SNAP-OFF UTILITY KNIFE



 Blister

Standard blades	3
Blade width	9 mm
Weight	0.03 kg

0612

CAT 42 € 2,50

STAINLESS STEEL SNAP-OFF UTILITY KNIFE



 Blister

Standard blades	3
Blade width	9 mm
Weight	0.04 kg

0611

CAT 42 € 2,33

STAINLESS STEEL SNAP-OFF UTILITY KNIFE



Blister

Standard blades	3
Blade width	9 mm
Weight	0.03 kg

0792

€ 8,60

AUTOMATIC SNAP-OFF UTILITY KNIFE, BLADES INCLUDED



Box

Standard blades	5
Blade width	25 x 0,7 mm

0095

€ 1,38

SNAP-OFF KNIFE SET

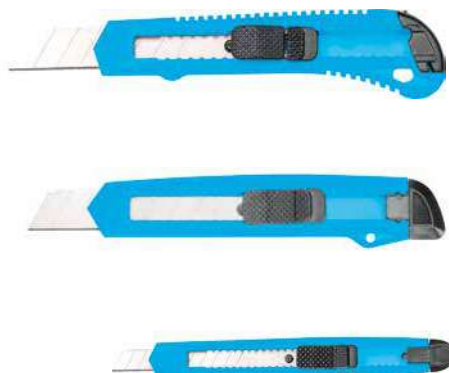

3 Pcs Hanging package

0035

€ 5,20

SECURITY SNAP-OFF UTILITY KNIFE, BLADES INCLUDED



Box

Standard blades	4
Trapezoidal blade	19 x 61 x 0,6 mm

0696

€ 6,40

FOLDABLE UTILITY KNIFE, BLADES INCLUDED



Blister

Standard blades	5
Blade width	20 mm

0696/L

€ 1,58

PAPER CUTTER BLADE SET

10 Pcs Plastic case

Trapezoidal blade	19 x 61 x 0,6 mm
-------------------	------------------



0627/L

€ 1,72

10-PC PAPER CUTTER BLADE SET

10 Pcs Plastic case

Blade length	9 mm
--------------	------



test

0096/L

€ 1,72

PAPER CUTTER BLADE SET



10 Pcs Plastic case

Blade length 104 mm

0792/L

€ 6,60

PAPER CUTTER BLADE SET



10 Pcs Plastic case

Blade width 25 mm

S002

€ 12,20

EXTENSIBLE DEBURRING TOOL WITH 3 BLADES

ONE FOR EACH TYPE E100, E200, E300, DIAMETER Ø 3,2 mm



HSS

Blade ø 3,2 mm

0420

€ 5,80

DEBURRING TOOL WITH 1 BLADE

WITH 1 TYPE E100 BLADE, DIAMETER Ø 3,2 mm, PLASTIC HANDLE



HSS

Length	120 mm
Max. handle diameter	9,2 mm
Blade	Ø 3,2 mm
Blade material	HSS

0411

€ 11,30

DEBURRING TOOL WITH 1 BLADE

WITH 1 TYPE E100 BLADE, DIAMETER Ø 3,2 mm TPR AND PLASTIC HANDLE



HSS

Length	124 mm
Max. handle diameter	29 mm
Blade	ø 3,2 mm
Blade material	HSS

0415

€ 7,70

DEBURRING TOOL WITH 2 BLADE

WITH 2 TYPES E100 AND E200 BLADES, DIAMETER Ø 3,2 mm, PLASTIC HANDLE



HSS

Length	125 mm
Max. handle diameter	22 mm
Blade	ø 3,2 mm
Blade material	HSS

S002/E100

€ 12,10

HSS LONG SHANK BLADE SET

FOR INTERNAL AND EXTERNAL DEBURRING FOR LONG CHIPS MATERIAL LIKE STEEL, ALUMINUM, PLASTIC MATERIALS



10 Pcs HSS

S002/E200

€ 11,30

HSS BIDIRECTIONAL BLADE SET

FOR INTERNAL AND EXTERNAL DEBURRING SHORT CHIPS MATERIAL LIKE BRASS AND CAST IRON



10 Pcs HSS

S002/E300

€ 12,10

HSS BIDIRECTIONAL BLADE SET

FOR INTERNAL AND EXTERNAL DEBURRING FOR HOLES UNTIL 4 mm OF THICKNESS



10 Pcs HSS

S005

€ 11,40

DOUBLE DEBURRER WITH HSS DISK BLADE

FOR STEEL, ALUMINUM, BRASS, COPPER AND PLASTIC SHEETS DEBURRING MAX 10 mm



HSS

S005/R

€ 12,70

DISK BLADE SET



4 Pcs HSS Color box

0384

€ 5,20

INNER-OUTER REAMER

FOR PLASTIC, COPPER AND FERROUS METALS



Capacity 3 + 32 mm 3/16" + 1-1/2"

0647/25

€ 14,00

PAINT SCRAPER WITH 25 mm CARBIDE BLADE THREE CUTTING EDGES



Blister

0647/50

€ 14,60

PAINT SCRAPER WITH 50 mm CARBIDE BLADE TWO CUTTING EDGES



Blister

0647/65

€ 15,90

PAINT SCRAPER WITH 65 mm CARBIDE BLADE TWO CUTTING EDGES



Blister

0647/25L

€ 11,40

2-PCS BLADE SET



0647/50L

€ 11,60

2-PCS BLADE SET



0647/65L

€ 11,60

2-PCS BLADE SET



TEST

0367

€ 21,50

CARVING KNIFE SET



34 Pcs Blister

Grindstone	1 - grana / grain 240
Precision screwdriver	1
Tweezers	1
Double color grip	4
Carving knife blades	26
Plastic case	1, ABS+TPR

0389-

MULTIFUNCTION PLIER

ANODIZED ALUMINUM HANDLE, NYLON HOLSTER



AISI 420

Art.	€	Length	12 stainless steel tools
0389/01	€ 11,60	69 mm	AISI 420
0389/02	€ 15,30	102 mm	AISI 420

0869

€ 12,10

HANDSAW FOR JOINER WITH TRIPLE DRESSED SHARPENING DIAMOND TYPE



Blade length 400 mm

0226

€ 7,60

HACKSAW FRAME WITH ALUMINUM ALLOY HANDLE WITH HANDLE FOR SMALL CUT

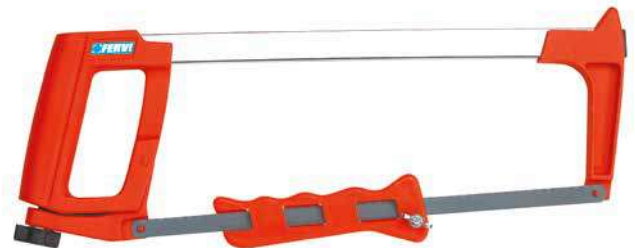

Blade length 310 mm

0629

€ 16,70

HACKSAW WITH BLADE AND ALUMINUM BODY



Blade length 300 mm

0161

€ 3,20

MINI HACKSAW WITH BLADE



Blade length 150 mm

0327

€ 6,30

BOW HANDSAW FOR WOOD



Blade length 530 mm / 21"
Weight 0,5 kg

0670

€ 43,10

NIBBLER FOR POWER DRILL

DOUBLE HEAD NIBBLER, WITH ACCESSORY FOR ROUND AND STRAIGHT CUTTING PURPOSE



0670/U

€ 11,40

CUTTER HOLDERS

Cutting capacity	
iron plates	1,8 mm
stainless steel plate	1,2 mm
copper and aluminum plate	2,0 mm
plastic materials	2,0 mm
Round speed	1500 ÷ 3000 rpm
Collar	Ø 43,2 mm
Weight	400 g
Metal box	

0655/S

€ 7,90

STRAIGHT AVIATION TIN SNIP

WITH SERRATED AND HARDENED BLADE AND ERGONOMIC HANDLES CHROME-VANADIUM



Blister

Length 245 mm
Hardness 50 - 52 HRC

0724/B

€ 1,60

BI-METAL HACK SAW BLADE



Sizes 300 x 12,7 x 0,62 mm x 24T - 12" x 1/2" x 0.025" x 24T

0159

€ 0,23

HACKSAW BLADE



Sizes 300 x 12,7 x 0,62 mm x 24T - 12" x 1/2" x 0.025" x 24T

0655/L

€ 7,90

LEFT HAND AVIATION TIN SNIP

WITH SERRATED AND HARDENED BLADE AND ERGONOMIC HANDLES CHROME-VANADIUM



Blister

Length 245 mm
Hardness 50 - 52 HRC

0655/R

€ 7,90

RIGHT HAND AVIATION TIN SNIP

WITH SERRATED AND HARDENED BLADE AND ERGONOMIC HANDLES CHROME-VANADIUM



Blister

Length 245 mm
Hardness 50 - 52 HRC



0818/250

€ 8,80

TINMAN'S SNIPS



Blister

Length 250 mm

0699/240

€ 5,20

INOX SCISSORS

WITH NYLON HANDLE



Blister

Length 240 mm

0672

€ 6,30

ELECTRICIAN SCISSORS

WITH STAINLESS STEEL SERRATED BLADE, AND ERGONOMIC HANDLE IN ABS MATERIAL



Blister

Length 5" 1/2 - 140 mm

0672/B

€ 8,60

ELECTRICIAN SCISSORS

WITH STAINLESS STEEL SERRATED BLADE AND, BICOLOR NON-SLIP ERGONOMIC HANDLE



Blister

Length 5" 1/2 - 140 mm

0141

€ 9,30

ELECTRICIAN SCISSORS

PROFESSIONAL ELECTRICIAN STAINLESS STEEL SCISSORS



Blister

Length 5" 1/2 - 140 mm

F018

€ 21,70

INSULATED ELECTRICIAN SCISSORS

1000 V, WITH STAINLESS STEEL SERRATED BLADE, AND ERGONOMIC HANDLE IN ABS MATERIAL, IEC 60900



Blister

Length 6" - 160 mm

0673

€ 8,60

MULTIPURPOSE SCISSORS

WITH STAINLESS STEEL SERRATED BLADE, ERGONOMIC BICOLOR NON-SLIP PLASTIC AND RUBBER HANDLE



Blister

Length 175 mm / 7"

0325

€ 11,10

MULTIPURPOSE SCISSORS

WITH STAINLESS STEEL SERRATED BLADE AND ERGONOMIC BICOLOR NON-SLIP HANDLE



Blister

Length 210 mm / 8"

0424

€ 10,30

PUNCH PLIER

REINFORCED, 250 mm LONG, MADE OF STEEL. IT ALLOWS TO PERFORM SMALL HOLES ON MATERIALS OF SMALL THICKNESS SUCH AS: PAPER, CARDBOARD, RUBBER AND LEATHER



Blister

Length 250 mm
Weight 426 g

0093/22

€ 4,75

PIPE CUTTER FOR COPPER AND PLASTIC

WITH ZINC ALLOY BODY AND BEARING STEEL CUTTING BLADE, CUTTING SIZE 1 / 8" ÷ 55 / 64"



Cutting capacity 3÷22 mm , 1 / 8" ÷ 55 / 64"
Weight 100 g

0092

€ 5,20

COPPER TUBE CUTTER



Blister

Capacity 3 ÷ 28 mm - 1/8" ÷ 1 1/8"

0297

€ 57,10

RATCHET PLASTIC TUBE CUTTER



Color box

Max cut Ø 42 mm

0081

€ 26,40

HOLLOW PUNCH SET



9 Pcs Blow mold case

Sizes ø 5 - 6 - 8 - 10 - 12,5 - 16 - 20 - 25 - 32 mm

0093/42

€ 18,70

PIPE CUTTER FOR COPPER AND IRON

WITH ALUMINIUM ALLOY BODY, 9CRSI STEEL CUTTING BLADE AND HARDNESS OF HRC 58-60, CUTTING SIZE 15 / 64" ÷ 1-21 / 32"



Cutting capacity 6÷42 mm , 15 / 64" ÷ 1-21 / 32"
Weight 320 g

0472

€ 15,00

PIPE FLARING TOOL FOR COPPER AND ALUMINUM

MADE OF STEEL, FOR PIPES WITH SIZES OF 13/64", 15/64", 5/16", 25/64", 15/32", 35/64", 5/8"



Pipes diameter ø5 - 6 - 8 - 10- 12 - 14 - 16 mm
Weight 750 g

0844

€ 8,60

POLYURETHANE AND RUBBER HOSE CUTTER



Blister

Max cut Ø 25 mm

0253

€ 8,10

POLYURETHANE AND RUBBER HOSE CUTTER

SUITABLE FOR PE, PU AND RUBBER HOSES, BI-COMPONENT HANDLE



Max Opening	19 mm
Length	133 mm

0846/150

€ 97,50

RATCHET HAND CABLE CUTTER

FOR ELECTRIC CABLES



Blister

Cutting capacity	150 mm ² (Al - Cu)
Length	250 mm
Weight	0,66 kg

0287-

BOLT CUTTER

IDEAL FOR CUTTING IRON RODS, CHAINS AND A WIDE RANGE OF FERROUS AND NOT FERROUS MATERIALS



Cr-V

Art.	€	Dimensions
0287/300	€ 13,60	300 mm - 12"
0287/350	€ 15,50	350 mm - 14"
0287/450	€ 19,80	450 mm - 18"
0287/600	€ 25,00	600 mm - 24"
0287/750	€ 32,40	750 mm - 30"

0862

€ 5,80

ADJUSTABLE AUTOMATIC WIRE STRIPPER



Blister

Max cut	∅ 0,8 ÷ 3,5mm 0,25 ÷ 6 mm ²
---------	--

0801

€ 5,80

CABLE WIRE STRIPPER



Blister

Max cut	∅ 0,8 ÷ 28,0 mm
---------	-----------------



0863

€ 11,10

RATCHET PRUNING SHEARS



Blister

Length	205 mm
Max cut	∅ 24 mm

0513

€ 9,50

CAMP AXE WITH FIBRE-GLASS HANDLE



Total weight	1 kg
--------------	------

0842

€ 30,70

UNIVERSAL GRAFTING MACHINE



4 Pcs

0101/500

€ 7,50

CAMP AXE



Total weight	600 g
--------------	-------

0515

€ 21,70

AXE WITH FIBRE-GLASS HANDLE



Total weight	2,6 kg
Length	900 mm

0322

€ 37,50

TELESCOPIC RATCHET LOPPING SHEARS TEFLON COATED HARDENED BLADE



Hanging package

Length	690 - 1030 mm
--------	---------------

**0587-
STAPLES**

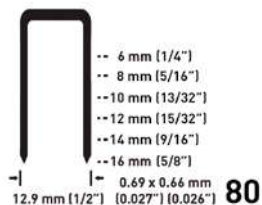

5000 Pcs

Art.	€	Model	Size
0587/8006	€ 5,80	80	12,9 x 6h mm
0587/8008	€ 6,70	80	12,9 x 8h mm
0587/8010	€ 7,30	80	12,9 x 10h mm
0587/8012	€ 8,00	80	12,9 x 12h mm
0587/8014	€ 8,60	80	12,9 x 14h mm
0587/8016	€ 9,30	80	12,9 x 16h mm

**0585-
STAPLES**

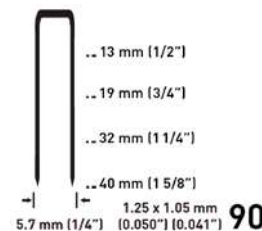

2500 Pcs

Art.	€	Model	Size
0585/9013	€ 5,90	90	5,7 x 13h mm
0585/9019	€ 8,30	90	5,7 x 19h mm
0585/9032	€ 10,50	90	5,7 x 32h mm
0585/9040	€ 11,30	90	5,7 x 40h mm

**0584-
NAILS**

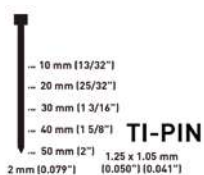

Art.	€	Model	Size
0584/F10	€ 5,80	TI-PIN	1,25 x 10h mm
0584/F15	€ 6,70	TI-PIN	1,25 x 15h mm
0584/F20	€ 8,60	TI-PIN	1,25 x 20h mm
0584/F25	€ 9,20	TI-PIN	1,25 x 25h mm
0584/F30	€ 10,30	TI-PIN	1,25 x 30h mm
0584/F35	€ 11,30	TI-PIN	1,25 x 35h mm
0584/F40	€ 12,70	TI-PIN	1,25 x 40h mm
0584/F45	€ 12,90	TI-PIN	1,25 x 45h mm
0584/F50	€ 13,10	TI-PIN	1,25 x 50h mm

**0588-
HEADLESS PINS**

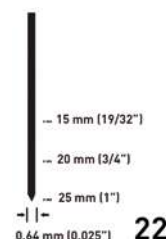

10000 Pcs

Art.	€	Model	Size
0588/615	€ 6,30	0,60	0,63 x 15h mm
0588/620	€ 7,80	0,60	0,63 x 20h mm
0588/625	€ 9,20	0,60	0,63 x 25h mm

**0150
NAILS** € 2,40

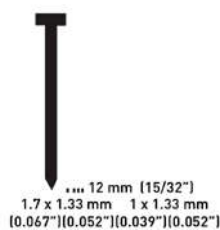

500 Pcs Blister

Head	1,7 x 1,33 mm
Stem	1 x 1,33 mm

**0151
STAPLES** € 2,52



500 Pcs Blister

Stem	0,58 x 1,2 mm
------	---------------

**0295
RIVET SET** € 9,10

25 PCS 2.4X6.4 mm; 25 PCS 2.4X8 mm;
25 PCS 3.2X5 mm; 25 PCS 3.2X6.4 mm;
25 PCS 3.2X8 mm; 25 PCS 4X6.4 mm; 25
PCS 4X8 mm; 25 PCS 4.8X6.4 mm; 25 PCS
4.8X8 mm;



225 Pcs Plastic box

**0376/AC
CAT 42** € 8,30

150 PCS CARBON STEEL NUT RIVET SET

YELLOW ZINC PLATED, M3: 40 PCS - M4:
40 PCS - M5: 30 PCS - M6: 20 PCS - M8:
10PCS - M10: 5 PCS - M12: 5 PCS



Nut rivets M3 - M4 - M5 - M6 - M8 - M10 - M12

0376/AL

CAT 42 € 10,40

120 PCS ALUMINUM NUT RIVET SET

M4: 50 PCS - M5: 35 PCS - M6: 15 PCS -
M8: 10PCS - M10: 10 PCS



Nut rivets

M4 - M5 - M6 - M8 - M10

0376/AI

CAT 42 € 29,20

150 PCS STAINLESS STEEL NUT RIVET SET

M3: 40 PCS - M4: 40 PCS - M5: 30 PCS
- M6: 20 PCS - M8: 10PCS - M10: 5 PCS -
M12: 5 PCS



Nut rivets

M3 - M4 - M5 - M6 - M8 - M10 - M12

0178

€ 8,80

WASHER SET

50 PCS GROWER #6; 50 PCS GROWER #8;
50 PCS GROWER #10; 40 PCS GROWER
1/4"; 30 PCS GROWER 5/16"; 20 PCS
GROWER 3/8"; 50 PCS NOTCHED OUT.
#6; 50 PCS NOTCHED OUT. #8; 50 PCS
NOTCHED OUT. #10; 40 PCS NOTCHED
OUT. 1/4"; 30 PCS NOTCHED OUT. 5/16";
20 PCS NOTCHED OUT. 3/8"; 50 PCS
NOTCHED INS. #6; 50 PCS NOTCHED INS.
#8; 50 PCS NOTCHED INS. #10; 40 PCS
NOTCHED INS. 1/4"; 30 PCS NOTCHED INS.
5/16"; 20 PCS NOTCHED INS. 3/8";



720 Pcs Plastic box

0229

€ 13,10

COPPER WASHER SET

30 PCS M6; 25 PCS M8; 20 PCS M10; 15
PCS M12; 10 PCS M14; 10 PCS M16;



110 Pcs Plastic box

0294

€ 9,30

COTTER PIN SET



555 Pcs Plastic box

0298

€ 8,60

HITCH PIN SET

42 PCS 3/32"X1-3/16"; 30 PCS 5/64"X1-
5/16"; 25 PCS 5/64"X1-9/16"; 25 PCS
7/64"X1-5/18"; 20 PCS 9/64"X1-3/4"; 8 PCS
5/32"X2-15/16";



150 Pcs Plastic box

0231

€ 9,40

ROLL PIN SET

4 PCS 4X16 mm; 4 PCS 4X26 mm; 4 PCS
4X40 mm; 4 PCS 6X16 mm; 4 PCS 6X32
mm; 4 PCS 6X45 mm; 4 PCS 8X20 mm; 4
PCS 8X40 mm; 4 PCS 8X50 mm; 4 PCS 2X6
mm; 4 PCS 2X14 mm; 4 PCS 2X26 mm; 4
PCS 1.5X5 mm; 4 PCS 1.5X20 mm; 4 PCS
1.5X8 mm; 4 PCS 2.5X16 mm; 4 PCS 2.5
X24 mm; 4 PCS 2.5X32 mm; 5 PCS 3X16
mm; 5 PCS 3X26 mm; 5 PCS 3X32 mm;
2 PCS 10X20 mm; 2 PCS 10X40 mm; 2
PCS 10X50 mm; 4 PCS 5.5X32 mm; 4 PCS
5.5X45 mm; 4 PCS 5.5X16 mm; 5 PCS 5X16
mm; 5 PCS 5X26 mm; 5 PCS 5X32 mm;



120 Pcs Plastic box

0296

€ 9,30

E-CLIP SET

30 PCS 1/16"; 30 PCS 1/8"; 40 PCS 3/16";
50 PCS 1/4"; 50 PCS 3/8"; 40 PCS 1/2"; 20
PCS 5/8"; 20 PCS 3/4"; 20 PCS 7/8";



300 Pcs Plastic box

0179

€ 8,60

SNAP RING SET

3 PCS Ø 32; 5 PCS Ø 25; 5 PCS Ø 22; 10 PCS Ø 16; 10 PCS Ø 14; 10 PCS Ø 10; 5 PCS R14; 10 PCS R12; 10 PCS R10; 10 PCS Ø 9; 10 PCS Ø 8; 12 PCS Ø 6;



100 Pcs Plastic box

0257

€ 11,30

PARALLEL KEY SET

5 PCS 6X6X20 mm; 4 PCS 3X3X20 mm; 4 PCS 3X3X25 mm; 5 PCS 8X5X32 mm; 5 PCS 5X5X20 mm; 5 PCS 8X7X36 mm; 5 PCS 5X5X25 mm; 5 PCS 10X8X40 mm; 5 PCS 5X5X36 mm; 5 PCS 10X8X50 mm; 5 PCS 6X6X36 mm; 2 PCS 12X8X40 mm; 5 PCS 6X6X50 mm;



60 Pcs Plastic box

0116P

€ 11,60

INCH CHROMED STEEL BALL SET

DIN 5401 GRADE, CLASS III 50PCS 3/32"; 50PCS 1/8"; 50PCS 5/32"; 50PCS 3/16"; 50PCS 7/32"; 50PCS 1/4"; 30PCS 9/32"; 30PCS 5/16"; 30PCS 11/32"; 20PCS 3/8"; 20PCS 13/32";



430 Pcs Plastic box

0299-

O-RING SET



419 Pcs Plastic box

Art.	€	Metric O-Ring
0299	€ 17,80	Metric
0299/P	€ 17,80	Inches

0263

€ 11,30

WOODRUFF METRIC KEY SET

10 PCS 4X7.5X19 mm; 10 PCS 5X7.5X19 mm; 10 PCS 3X5X13 mm; 10 PCS 3X6.5X16 mm; 10 PCS 4X5X13 mm; 10 PCS 4X6.5X16 mm; 10 PCS 5X9X22 mm; 10 PCS 6X9X22 mm;



80 Pcs Plastic box

0116

€ 9,30

METRIC CHROMED STEEL BALL SET

DIN 5401 GRADE, CLASS III 50PCS 2.00MM; 50PCS 2.50MM; 50PCS 3.00MM; 50PCS 3.50MM; 50PCS 4.00MM; 50PCS 4.50MM; 50PCS 5.00MM; 30PCS 5.50MM; 30PCS 6.00MM; 20PCS 7.00MM; 20PCS 8.00MM;



450 Pcs Plastic box

0180

€ 9,30

SPRING SET

20 TYPES: 8 COMPRESSION, 12 EXTENSION 10 PCS COMP. 9/32" X 1/2"; 10 PCS EXT. 13/64" X 13/16"; 10 PCS COMP. 3/8" X 5/8"; 10 PCS EXT. 5/16" X 1-1/8"; 10 PCS COMP. 1/4" X 13/32"; 10 PCS EXT. 7/32" X 1"; 10 PCS COMP. 3/8" X 3/4"; 10 PCS COMP. 7/32" X 11/16"; 10 PCS EXT. 1/4" X 7/8"; 10 PCS EXT. 5/16" X 1-1/4"; 10 PCS EXT. 11/32" X 1-27/32"; 10 PCS EXT. 5/16" X 1-3/4"; 10 PCS EXT. 9/32" X 2"; 10 PCS EXT. 5/32" X 3-1/8"; 10 PCS COMP. 23/64" X 1-3/8"; 10 PCS EXT. 3/16" X 1-3/4"; 10 PCS COMP. 7/32" X 1-1/2"; 10 PCS EXT. 9/32" X 1-1/2"; 10 PCS COMP. 9/32" X 3/4"; 10 PCS EXT. 11/32" X 1-7/16";



200 Pcs Plastic box

0177

€ 9,10

O-RING SET

10 PCS 3/32" X 15/64"; 20 PCS 1/8" X 1/4"; 20 PCS 5/32" X 9/32"; 20 PCS 3/16" X 5/16"; 15 PCS 7/32" X 11/32"; 15 PCS 1/4" X 3/8"; 10 PCS 9/16" X 3/4"; 10 PCS 5/8" X 13/16"; 10 PCS 11/16" X 7/8"; 10 PCS 3/4" X 15/16"; 10 PCS 3/4" X 1"; 10 PCS 13/16" X 11/16"; 15 PCS 5/16" X 7/16"; 10 PCS 3/8" X 1/2"; 10 PCS 5/8" X 3/4"; 10 PCS 3/8" X 9/16"; 10 PCS 7/16" X 5/8"; 10 PCS 1/2" X 11/16";



225 Pcs Plastic box

0828

€ 2,20

HOSE CLIP SET



6 Pcs Blister

Dimension \varnothing 6 + 45 mm

0261

€ 7,80

HOSE CLIP SET

2 PCS 12.8X0.9X50-70 mm; 4 PCS 12.8X0.9X35-50 mm; 8 PCS 12.8X0.9X25-40 mm; 6 PCS 10X0.8X12-22 mm;



20 Pcs Plastic box

Dimension 10 x 0,8 x 12-22 mm ; 12,8 x 0,9 x 25-40 mm; 12,8 x 0,9 x 35-50 mm; 12,8 x 0,9 x 50-70 mm

0876

€ 10,30

NYLON CABLE TIE SET



650 Pcs

300 Pcs	2,5 x 100 mm
200 Pcs	3,6 x 150 mm
150 Pcs	4,8 x 200 mm
Weight	450 g

0398

€ 8,00

SCREW AND U TYPE CUSHIONS ASSORTMENT

SCREWS: 3X8MM 40PCS 4X16MM 20PCS 5X12MM 15PCS 6X20MM 10PCS U CLIPS: 3MM 20PCS 4MM WITH NOTCH 20PCS 4MM 20PCS 5MM 15PCS 6MM 10PCS



170 Pcs Plastic box

0465

€ 7,50

RUBBER GROMMET ASSORTMENT

GROMMETS SIZES: 5 PCS - D 21 mm - ID 15 mm - OD 26 mm - T 2,2 mm 40 PCS - D 9 mm - ID 6 mm - OD 13 mm - T 2,1 mm 5 PCS - D 15 mm - ID 12 mm - OD 19 mm - T 1,9 mm 40 PCS - D 5,8 mm - ID 2,5 mm - OD 7,9 mm - T 1,8 mm 40 PCS - D 7,5 mm - ID 4,8 mm - OD 9,8 mm - T 1,8 mm 20 PCS - D 12 mm - ID 10,5 mm - OD 15 mm - T 1,8 mm 25 PCS - D 11 mm - ID 8,5 mm - OD 14,5 mm - T 1,5 mm 5 PCS - D 25 mm - ID 18 mm - OD 32 mm - T 1,5 mm



180 Pcs Plastic box

0468

€ 8,30

CONNECTING PLATE AND SCREW ASSORTMENT

4 PCS ASSEMBLY SQUARE: 25x25x16x2.0MM 8 PCS ASSEMBLY SQUARE: 40x40x16x2.0MM 4 PCS ASSEMBLY SQUARE: 60x60x16x2.0MM 4 PCS ASSEMBLY SQUARE: 75x75x16x2.0MM 4 PCS L FLAT ANGLE PLATE: 40x40x12x2.0MM 4 PCS L FLAT ANGLE: 60x60x12x2.0MM 4 PCS FLAT PLATE CONNECTOR: 80x15x2.0MM 4 PCS FLAT PLATE CONNECTOR: 40x15x2.0MM 144 PCS SCREWS: 3x16MM



180 Pcs Plastic box

0307/1

€ 16,70

GLASS FUSE SET

FAST: 10 X 1A F1, 10 X 1.25A F1, 10 X 1.6A F1, 10 X 2A F1, 10 X 2.5A F1, 10 X 4A F1, 10 X 5A F1, 10 X 6.3A F1, 10 X 10A F1, TIME DELAY: 10 X 1A F1 T, 10 X 1.25A F1 T, 10 X 1.6A F1 T, 10 X 2A F1 T, 10 X 2.5A F1 T, 10 X 4A F1 T, 10 X 5A F1 T, 10 X 6.3A F1 T, 10 X 10A F1 T,



180 Pcs Plastic box

Dimensions 5 x 20 mm

0307/2

€ 18,80

GLASS FUSE SET

TIME DELAY: 10 PCS 100 MA T, 10 PCS 160 MA T, 10 PCS 200 MA T, 10 PCS 250 MA T, 10 PCS 315 MA T, 10 PCS 400 MA T, 10 PCS 500 MA T, 10 PCS 630 MA T, 10 PCS 800 MA T, FAST: 10 PCS 100 MA F, 10 PCS 160 MA F, 10 PCS 200 MA F, 10 PCS 250 MA F, 10 PCS 315 MA F, 10 PCS 400 MA F, 10 PCS 500 MA F, 10 PCS 630 MA F, 10 PCS 800 MA F



180 Pcs Plastic box

Dimensions 5 x 20 mm

0317

CAR FUSE SET

€ 10,00



Dimensions 19.1 x 5.1 x 18.5 mm

0318

CAR FUSE SET

€ 10,80



Dimensions 10.9 x 3.6 x 16.3 mm

0293

INSULATED TERMINAL SET

€ 12,20

15 PCS FDD1-110 2.8X0.5/0.8 mm; 15 PCS FDD1-187 4.75X0.5/0.8 mm; 10 PCS FDD2-187 6.35X0.5/0.8 mm; 15 PCS FDD1-250 4.75X0.5/0.8 mm; 10 PCS FDD2-250 6.35X0.8 mm; 10 PCS FDD5-250 6.35X0.8 mm; 10 PCS BV1; 10 PCS BV2; 10 PZ BV5; 10 PCS MDD1-250; 10 PCS MDD2-250; 10 PCS MDD5-250; 10 PCS SVL1.25-3.7; 10 PCS SVL1.25-4; 10 PCS SVL1.25-5.3; 10 PCS SVM2-4; 10PCS SVS2-5; 10 PCS SVL5-4; 10 PCS SVL5.5-4;



200 Pcs Plastic box

0877

END TERMINAL SET

€ 9,50

50 PCS 0.5MM²; 100 PCS 0.75MM²; 100 PCS 1.0 mm²; 100 PCS 1.5 mm²; 50 PCS 2.5 mm²;

400 Pcs

White end	50 x 0,5 mm ²
Grey end	100 x 0,75 mm ²
Red end	100 x 1 mm ²
Black end	100 x 1,5 mm ²
Blue end	50 x 2,5 mm ²
Weight	80 g



0380

PVC SHRINKABLE TUBE ASSORTMENT

€ 8,60

30 PCS 5/64"X1-9/16"; 25 PCS 3/32"X1-9/16"; 20 PCS 1/8"X1-9/16"; 30 PCS 3/16"X1-9/16"; 16 PCS 9/32"X3-1/8"; 8 PCS 3/8"X3-1/8"; 8 PCS 1/2"X3-3/8";



127 Pcs Plastic box

0176

GREASE FITTING SET

€ 26,80

PCS. 35 STRAIGHT M6X1; PCS. 15 STRAIGHT 1/8"-27; PCS. 5 45° 1/8"-27; PCS. 5 45° M6X1; PCS. 10 45° M8X1; PCS. 5 45° M10X1; PCS. 10 STRAIGHT M10X1; PCS. 10 STRAIGHT M8X1; PCS. 5 90° M6X1; PCS. 5 90° M8X1; PCS. 5 90° M10X1.

110 Pcs Plastic box



SR44W

BATTERIES FOR DIGITAL INSTRUMENTS

€ 4,67



Voltage 1,5V

CR20x

BATTERIES FOR DIGITAL INSTRUMENTS



Art.	€	Voltage
CR2025	€ 6,40	3 V
CR2032	€ 6,40	3 V





THE OPTIMAL SOLUTION TO FURNISH YOUR WORKSHOP, YOUR GARAGE OR YOUR RACING CORNER

CHOOSE FROM THE COMPOSITIONS CREATED FOR YOU BY FERVI OR CONFIGURE YOUR MODULAR AND SELF-SUPPORTING WORKSHOP FURNITURE ACCORDING TO YOUR NEEDS



A007/07

PANELS CONNECTOR
NECESSARY TO CONNECT THE MODULES

A007/02

TALL CABINET
WITH 3 SHELVES

A007/10

HANGING PANEL

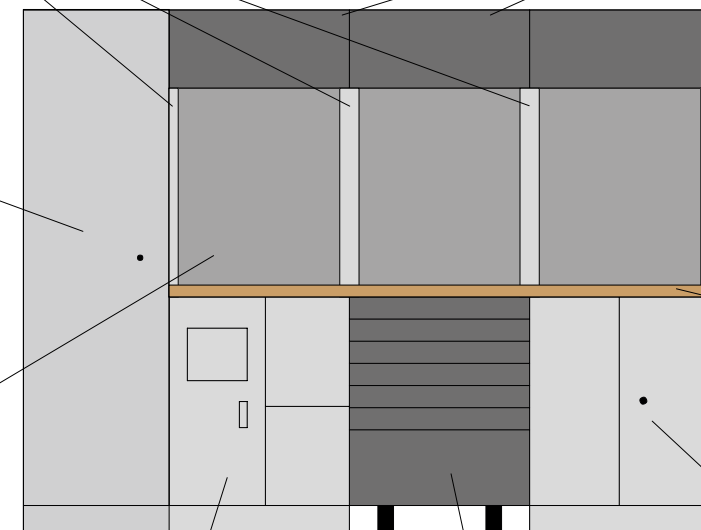

A007/01

WALL CABINET
TO FIX ON THE HANGER PANEL

A007/11

HALF PANEL CONNECTOR
TO END THE CONFIGURATION WITHOUT THE CABINET

A007/09

WORK PLATES
AVAILABLE IN 3 MEASUREMENTS AND 2 MATERIALS

A007/03

DOOR CABINET
IT MUST BE INSERTED IN THE CENTRAL SPACE OF A 3-MODULE PLAN

A007/06

MULTIFUNCTION CABINET

A007/16

ROLLING CABINET
WITH 7 DRAWERS ON BALL BEARING SLIDE

EXAMPLE OF CONFIGURATION WITH THREE MODULES WITH CABINET

A007A

***CAT 42 € 3540,00**

WORKSHOP MODULAR FURNITURES

- 4 WALL CABINET WITH SPRING GAS [A007/01]
- 2 TALL CABINETS WITH 3 SHELVES [A007/02]
- 1 DOOR CABINET WITH ONE SHELF [A007/03]
- 1 TOOL CABINET WITH 4 DRAWERS ON BALL BEARING SLIDE [A007/04]
- 2 TOOL CABINETS WITH 5 DRAWERS ON BALL BEARING SLIDES [A007/05]
- 5 PANELS CONNECTORS [A007/07]
- 2 WOOD PLATES [A007/08]
- 4 HANGING PANELS [A007/10]

Dimensions 3920 x 498 x 2000h mm



A008A € 3720,00

WITH STAINLESS STEEL PLATES

A007B

***CAT 42 € 3470,00**

WORKSHOP MODULAR FURNITURES

- 4 WALL CABINET WITH SPRING GAS [A007/01]
- 2 TALL CABINETS WITH 3 SHELVES [A007/02]
- 1 DOOR CABINET WITH ONE SHELF [A007/03]
- 2 TOOL CABINETS WITH 5 DRAWERS ON BALL BEARING SLIDES [A007/05]
- 1 MULTIFUNCTION CABINET [A007/06]
- 5 PANELS CONNECTORS [A007/07]
- 2 WOOD PLATES [A007/08]
- 4 HANGING PANELS [A007/10]

Dimensions 3920 x 498 x 2000h mm



A008B € 3630,00

WITH STAINLESS STEEL PLATES

A007C

***CAT 42 € 1710,00**

WORKSHOP MODULAR FURNITURES

- 2 WALL CABINET WITH SPRING GAS [A007/01]
- 1 TALL CABINET WITH 3 SHELVES [A007/02]
- 1 DOOR CABINET WITH ONE SHELF [A007/03]
- 1 TOOL CABINETS WITH 5 DRAWERS ON BALL BEARING SLIDES [A007/05]
- 2 HANGING PANELS [A007/10] 2 PANELS CONNECTORS [A007/07]
- 1 WOOD PLATE [A007/08]
- 1 HALF PANEL CONNECTOR [A007/11]

Dimensions 1960 x 498 x 2000h mm



A008C € 1790,00

WITH STAINLESS STEEL PLATES

A007D

***CAT 42 € 2380,00**

WORKSHOP MODULAR FURNITURES

- 3 WALL CABINET WITH SPRING GAS [A007/01]
- 1 TALL CABINET WITH 3 SHELVES [A007/02]
- 1 DOOR CABINET WITH ONE SHELF [A007/03]
- 1 TOOL CABINET WITH 4 DRAWERS ON BALL BEARING SLIDE [A007/04]
- 1 TOOL CABINETS WITH 5 DRAWERS ON BALL BEARING SLIDES [A007/05]
- 3 PANELS CONNECTORS [A007/07]
- 1 WOOD PLATE [A007/09]
- 3 HANGING PANELS [A007/10]
- 1 HALF PANEL CONNECTOR [A007/11]

Dimensions 2640 x 498 x 2000h mm



A008D € 2490,00

WITH STAINLESS STEEL PLATES



A007E

***CAT 42 € 1960,00**

WORKSHOP MODULAR FURNITURES

- 3 WALL CABINETS WITH SPRING GAS [A007/01]
- 1 TALL CABINET WITH 3 SHELVES [A007/02]
- 1 DOOR CABINET WITH ONE SHELF [A007/03]
- 1 MULTIFUNCTION CABINET [A007/06]
- 3 PANELS CONNECTOR [A007/07]
- 1 WOOD PLATE [A007/09]
- 3 HANGING PANELS [A007/10]
- 1 HALF PANEL CONNECTOR [A007/11]
- 1 ROLLING CABINET WITH 7 DRAWERS ON BALL BEARING SLIDES [A007/16]

Dimensions 2640 x 498 x 2000h mm



A008E € 2040,00

WITH STAINLESS STEEL PLATES

A007F

***CAT 42 € 917,00**

CORNER FOR WORKSHOP MODULAR FURNITURES

THE OPTIMAL SOLUTION TO FURNISH YOUR WORKSHOP, YOUR GARAGE OR YOUR RACING CORNER



Overall sizes 864 x 864 x 2000h mm

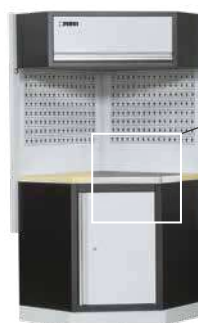

A008F € 967,00

WITH STAINLESS STEEL PLATES

A007G

***CAT 42 € 2020,00**

WORKSHOP MODULAR FURNITURES

- 3 WALL CABINET WITH SPRING GAS [A007/01]
- 1 TALL CABINET WITH 3 SHELVES [A007/02]
- 1 DOOR CABINET WITH ONE SHELF [A007/03]
- 1 MULTIFUNCTION CABINET [A007/06]
- 3 PANELS CONNECTORS [A007/07]
- 1 WOOD PLATE [A007/09]
- 3 HANGING PANELS [A007/10]
- 1 HALF PANEL CONNECTOR [A007/11]
- 1 TOOL CABINETS WITH 7 DRAWERS ON BALL BEARING SLIDES [A007/1]

Overall sizes 2640 x 498 x 2000h mm



A008G € 2130,00

WITH STAINLESS STEEL PLATES

A007H

***CAT 42 € 3830,00**

WORKSHOP MODULAR FURNITURES

- 5 WALL CABINET WITH SPRING GAS [A007/01]
- 1 TALL CABINETS WITH 3 SHELVES [A007/02]
- 1 DOOR CABINET WITH ONE SHELF [A007/03]
- 1 TOOL CABINET WITH 4 DRAWERS ON BALL BEARING SLIDE [A007/04]
- 1 TOOL CABINET WITH 5 DRAWERS ON BALL BEARING SLIDE [A007/05]
- 1 MULTI FUNCTION CABINET [A007/06]
- 6 PANELS CONNECTORS [A007/07]
- 1 WOOD PLATE [A007/08]
- 1 WOOD PLATE [A007/09]
- 5 HANGING PANELS [A007/10]
- 3 HALF PANEL CONNECTORS [A007/11]
- 2 CORNER HANGING PANELS [A007/12]
- 1 CORNER CABINET [A007/13]
- 1 CORNER WOOD PLATE [A007/14]
- 1 CORNER DOOR CABINET [A007/15]
- 1 ROLLING CABINET WITH 7 DRAWERS ON BALL BEARING SLIDE [A007/16]

Dimensions 3500 x 2250 x 2000h mm
Depth 498 mm



A008H € 4030,00

A007I

***CAT 42 € 1830,00**

WORKSHOP MODULAR FURNITURES

- 2 WALL CABINET WITH SPRING GAS [A007/01]
- 1 TALL CABINETS WITH 3 SHELVES [A007/02]
- 1 MULTI FUNCTION CABINET [A007/06]
- 2 PANELS CONNECTORS [A007/07]
- 1 WOOD PLATE [A007/08]
- 2 HANGING PANELS [A007/10]
- 1 HALF PANEL CONNECTOR [A007/11]
- 1 TOOL CABINET WITH 7 DRAWERS ON BALL BEARING SLIDE [A007/17]

Dimensions 1960 x 498 x 2000h mm



A008I € 1920,00

WITH STAINLESS STEEL PLATES

A007L

***CAT 42 € 4040,00**

WORKSHOP MODULAR FURNITURES

- 4 WALL CABINET WITH SPRING GAS [A007/01]
- 2 TALL CABINETS WITH 3 SHELVES [A007/02]
- 1 DOOR CABINET WITH ONE SHELF [A007/03]
- 1 TOOL CABINET WITH 4 DRAWERS ON BALL BEARING SLIDE [A007/04]
- 1 MULTI FUNCTION CABINET [A007/06]
- 6 PANELS CONNECTORS [A007/07]
- 2 WOOD PLATES [A007/08]
- 4 HANGING PANELS [A007/10]
- 2 HALF PANEL CONNECTORS [A007/11]
- 2 CORNER HANGING PANELS [A007/12]
- 1 CORNER CABINET [A007/13]
- 1 CORNER WOOD PLATE [A007/14]
- 1 CORNER DOOR CABINET [A007/15]
- 1 TOOL CABINET WITH 7 DRAWERS ON BALL BEARING SLIDE [A007/17]

Dimensions 2800 x 2800 x 2000h mm
Depth 498 mm



A008L € 4250,00

A007M

***CAT 42 € 1230,00**

WORKSHOP MODULAR FURNITURES

- 2 WALL CABINET WITH SPRING GAS [A007/01]
- 1 DOOR CABINET WITH ONE SHELF [A007/03]
- 1 TOOL CABINET WITH 5 DRAWERS ON BALL BEARING SLIDE [A007/05]
- 2 PANELS CONNECTORS [A007/07]
- 1 WOOD PLATE [A007/08]
- 2 HANGING PANELS [A007/10]
- 2 HALF PANEL CONNECTORS [A007/11]

Dimensions 1360 x 498 x 2000h mm



A008M € 1300,00

WITH STAINLESS STEEL PLATES

A007N

***CAT 42 € 1980,00**

WORKSHOP MODULAR FURNITURES

- 3 WALL CABINET WITH SPRING GAS [A007/01]
- 1 DOOR CABINET WITH ONE SHELF [A007/03]
- 1 TOOL CABINET WITH 4 DRAWERS ON BALL BEARING SLIDE [A007/04]
- 1 TOOL CABINET WITH 5 DRAWERS ON BALL BEARING SLIDE [A007/05]
- 3 PANELS CONNECTORS [A007/07]
- 1 WOOD PLATE [A007/09]
- 3 HANGING PANELS [A007/10]
- 2 HALF PANEL CONNECTORS [A007/11]

Dimensions 2040 x 498 x 2000h mm



A008N € 2080,00

WITH STAINLESS STEEL PLATES



A007P

***CAT 42 € 3710,00**

WORKSHOP MODULAR FURNITURES

- 4 WALL CABINET WITH SPRING GAS [A007/01]
- 2 TALL CABINETS WITH 3 SHELVES [A007/02]
- 1 DOOR CABINET WITH ONE SHELF [A007/03]
- 1 MULTIFUNCTION CABINET [A007/06]
- 5 PANELS CONNECTORS [A007/07]
- 1 WOOD PLATE [A007/09]
- 4 HANGING PANELS [A007/10]
- 1 TOOL CABINET WITH 7 DRAWERS ON BALL BEARING SLIDES [A007/16]
- 1 WOOD PLATE [A007/19]
- 1 TOOL CABINET WITH 9 DRAWERS ON BALL BEARING SLIDES [A007/20]



A008P € 3880,00
WITH STAINLESS STEEL PLATES

Dimensions 3920 x 498 x 2000h mm

A007Q

***CAT 42 € 1920,00**

WORKSHOP MODULAR FURNITURES

THE OPTIMAL SOLUTION TO FURNISH YOUR WORKSHOP, YOUR GARAGE OR YOUR RACING CORNER

- 2 WALL CABINET WITH SPRING GAS [A007/01]
- 1 TALL CABINET WITH 3 SHELES [A007/02]
- 1 TOOL CABINET WITH 4 DRAWERS ON BALL BEARING SLIDE [A007/04]
- 2 PANELS CONNECTORS [A007/07]
- 1 WOOD PLATE [A007/08]
- 2 HANGING PANELS [A007/10]
- 1 HALF PANEL CONNECTOR [A007/11]
- 1 TOOL CABINET WITH 9 DRAWERS ON BALL BEARING SLIDE [A007/20]



A008Q € 2000,00
WITH STAINLESS STEEL PLATES

Dimensions 1960 x 498 x 2000h mm

A007R

***CAT 42 € 825,00**

WORKSHOP MODULAR FURNITURES

- 1 WALL CABINET WITH SPRING GAS [A007/01]
- 2 PANELS CONNECTORS [A007/07]
- 1 HANGING PANEL [A007/10]
- 2 HALF PANEL CONNECTORS [A007/11]
- 1 WOOD PLATE [A007/19]
- 1 TOOL CABINET WITH 9 DRAWERS ON BALL BEARING SLIDE [A007/20]



A008R € 867,00
WITH STAINLESS STEEL PLATES

Dimensions 680 x 498 x 2000h mm

A007S

CAT 42 € 2230,00

WORKSHOP MODULAR FURNITURES

- 3 WALL CABINET WITH SPRING GAS [A007/01]
- 1 TALL CABINET WITH 3 SHELVES [A007/02]
- 1 DOOR CABINET WITH ONE SHELF [A007/03]
- 1 TOOL CABINETS WITH 9 DRAWERS ON BALL BEARING SLIDES [A007/20]
- 3 PANELS CONNECTORS [A007/07]
- 1 WOOD PLATE [A007/09]
- 3 HANGING PANELS [A007/10]
- 1 HALF PANEL CONNECTOR [A007/11]
- 1 TROLLEY WITH 3 SHELVES [A007/22]



A008S € 2310,00
WITH STAINLESS STEEL PLATES

Overall sizes 2640 x 498 x 2000h mm



A007T

CAT 42 € 1780,00

WORKSHOP MODULAR FURNITURES

- 2 WALL CABINET WITH SPRING GAS [A007/01]
- 1 DOOR CABINET WITH ONE SHELF [A007/03]
- 1 TOOL CABINETS WITH 5 DRAWERS ON BALL BEARING SLIDES [A007/05]
- 2 PANELS CONNECTORS [A007/07]
- 1 WOOD PLATE [A007/08]
- 2 HANGING PANELS [A007/10]
- 1 HALF PANEL CONNECTOR [A007/11]
- 1 2 DOOR TALL CABINET WITH 3 SHELVES [A007/23]

Dimensions 2560 x 498 x 2000h mm



A008T € 1860,00

WITH STAINLESS STEEL PLATES

A007U

CAT 42 € 2340,00

WORKSHOP MODULAR FURNITURES

- 3 WALL CABINET WITH SPRING GAS [A007/01]
- 1 TALL CABINET WITH 3 SHELVES [A007/02]
- 1 DOOR CABINET WITH ONE SHELF [A007/03]
- 3 PANELS CONNECTORS [A007/07]
- 1 WOOD PLATE [A007/09]
- 3 HANGING PANELS [A007/10]
- 1 HALF PANEL CONNECTOR [A007/11]
- 1 TOOL CABINET WITH 7 DRAWERS ON BALL BEARING SLIDES [A007/17]
- 1 HOSE REELS CABINET [A007/18]

Overall sizes 2640 x 498 x 2000h mm



A008U € 2430,00

WITH STAINLESS STEEL PLATES

A007UF

CAT 42 € 2560,00

WORKSHOP MODULAR FURNITURES

- 3 WALL CABINET WITH SPRING GAS [A007/01]
- 1 TALL CABINET WITH 3 SHELVES [A007/02]
- 1 DOOR CABINET WITH ONE SHELF [A007/03]
- 3 PANELS CONNECTORS [A007/07]
- 1 WOOD PLATE [A007/09]
- 3 HANGING PANELS [A007/10]
- 1 HALF PANEL CONNECTOR [A007/11]
- 1 TOOL CABINET WITH 7 DRAWERS ON BALL BEARING SLIDES [A007/17]
- 1 HOSE REELS CABINET [A007/18]
- 1 AUTO RE-ENTERING CABLE REEL [0621/A3]
- 1 AUTO REWIND AIR HOSE REEL [0481/15]

Overall sizes 2640 x 498 x 2000h mm



A008UF € 2640,00

WITH STAINLESS STEEL PLATES

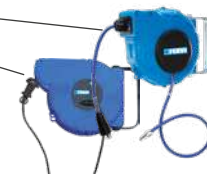

A007V

CAT 42 € 3710,00

WORKSHOP MODULAR FURNITURES

- 4 WALL CABINET WITH SPRING GAS [A007/01]
- 2 TALL CABINETS WITH 3 SHELVES [A007/02]
- 1 DOOR CABINET WITH ONE SHELF [A007/03]
- 1 TOOL CABINET WITH 5 DRAWERS ON BALL BEARING SLIDES [A007/05]
- 1 MULTIFUNCTION CABINET [A007/06]
- 5 PANELS CONNECTORS [A007/07]
- 1 WOOD PLATE [A007/08]
- 4 HANGING PANELS [A007/10]
- 1 LARGE AMERICAN TOOL CABINET [A007/21]

Dimensions 3920 x 498 x 2000h mm



A008V € 3860,00

WITH STAINLESS STEEL PLATES



A007/02

TALL CABINET
WITH 3 SHELVES

CAT 42 € 493,00



Dimensions 600 x 458 x 2000 mm
Weight 56.00 kg

A007/23

2 DOOR TALL CABINET
WITH 3 SHELVES

CAT 42 € 625,00



Dimensions 1200 x 458 x 2000 mm
Weight 112.00 kg

A007/03

DOOR CABINET
WITH ONE SHELF

CAT 42 € 247,00



Dimensions 680 x 458 x 910 mm
Weight 31.50 kg

A007/06

MULTIFUNCTION CABINET

CAT 42 € 311,00



Dimensions 680 x 458 x 910 mm
Drawer dimensions 240 x 300 mm
Drawer capacity 25 kg
Weight 41.50 kg

A007/18

HOSE REELS CABINET

CAT 42 € 380,00



Dimensions 680 x 458 x 910 mm

A007/04

TOOL CABINET WITH 4 DRAWERS
ON BALL BEARING SLIDE

CAT 42 € 398,00



Dimensions 680 x 458 x 910 mm
Drawer dimensions 550 x 400 mm
Drawers height 1 x 68 mm - 1 x 145 mm - 2 x 214 mm
Drawer capacity 25 Kg
Weight 50.00 kg

A007/05

TOOL CABINET WITH 5 DRAWERS
ON BALL BEARING SLIDE

CAT 42 € 426,00



Dimensions 680 x 458 x 910 mm
Drawer dimensions 550 x 400 mm
Drawers height 1 x 68 mm - 4 x 145 mm
Drawer capacity 25 kg
Weight 49.00 kg

A007/17

TOOL CABINET WITH 7 DRAWERS
ON BALL BEARING SLIDE

CAT 42 € 458,00



Dimension 680 x 458 x 910 mm
Drawer dimensions 550 x 400 mm
Drawers height 5 x 74.5 mm - 2 x 153.5 mm
Weight 57.00 kg



A007/20

CAT 42 € 525,00

TOOL CABINET WITH 9 DRAWERS

ON BALL BEARING SLIDE



Dimensions	680 x 458 x 910 mm
Drawer dimensions	550 x 400 mm
Drawers height	9 x 74.5 mm

A007/22

CAT 42 € 200,00

TROLLEY

WITH 3 SHELVES

WITH 7 DRAWERS ON BALL BEARING SLIDE



Dimensions	648 x 458 x 865 mm
------------	--------------------

A007/16

CAT 42 € 493,00

ROLLING CABINET

WITH 7 DRAWERS ON BALL BEARING SLIDE

WITH 7 DRAWERS ON BALL BEARING SLIDE



Dimension	660 x 860 x 455 mm
Drawer dimensions	525 x 400 mm
Weight	53.00 kg

A007/21

CAT 42 € 825,00

LARGE AMERICAN TOOL CABINET

WITH WOODEN TOP



Dimensions	1360 x 458 x 945 mm
Drawer dimensions	1 - 1285 x 400 mm 6 - 810 x 400 mm
Drawers height	1 x 123,5 mm - 5 x 74,5 mm - 1 x 153,5 mm
Weight	80 kg

A007/21I

CAT 42 € 897,00

LARGE AMERICAN TOOL CABINET

WITH STAINLESS STEEL TOP



Dimensions	1360 x 458 x 948,5 mm
Drawer dimensions	1 - 1285 x 400 mm 6 - 810 x 400 mm
Drawers height	1 x 123,5 mm - 5 x 74,5 mm - 1 x 153,5 mm

A007/01

CAT 42 € 142,00

WALL CABINET

WITH SPRING GAS



Dimensions	680 x 281 x 350 mm
Weight	11.00 kg

A007/10

CAT 42 € 70,00

HANGING PANEL



Dimensions	1052 x 614.5 x 24 mm
Weight	7.50 kg



A007/11

CAT 42 € 15,80

HALF PANEL CONNECTOR



Weight 1.81 kg

A007/07

CAT 42 € 17,50

PANELS CONNECTOR



Weight 2.50 kg

A007-xP

CAT 42

WORK PLATES



Art.	€	Module	Material	Dimensions	Thickness	Weight
A007/08	€ 128,00	2	Wood	1360 x 460 mm	35 mm	15.50 kg
A007/08I	€ 208,00	2	Stainless steel	1360 x 460 mm	35 mm	15.50 kg
A007/09	€ 202,00	3	Wood	2040 x 460 mm	35 mm	23.00 kg
A007/09I	€ 295,00	3	Stainless steel	2040 x 460 mm	35 mm	23.00 kg
A007/19	€ 72,50	1	Wood	680 x 460 mm	35 mm	7.80 kg
A007/19I	€ 125,00	1	Stainless steel	680 x 460 mm	35 mm	7.80 kg

A007/LED

€ 32,50

LED LIGHT FOR WORKSHOP MODULAR FURNITURES

WITH BI-ADHESIVE TAPE, TO BE USED IN COUPLING WITH A007 / LED / CB CHARGER. TWO LED STRIPS CAN BE CONNECTED IN SERIES.



A007/LED/C

€ 14,20

LED LIGHT POWER SUPPLY



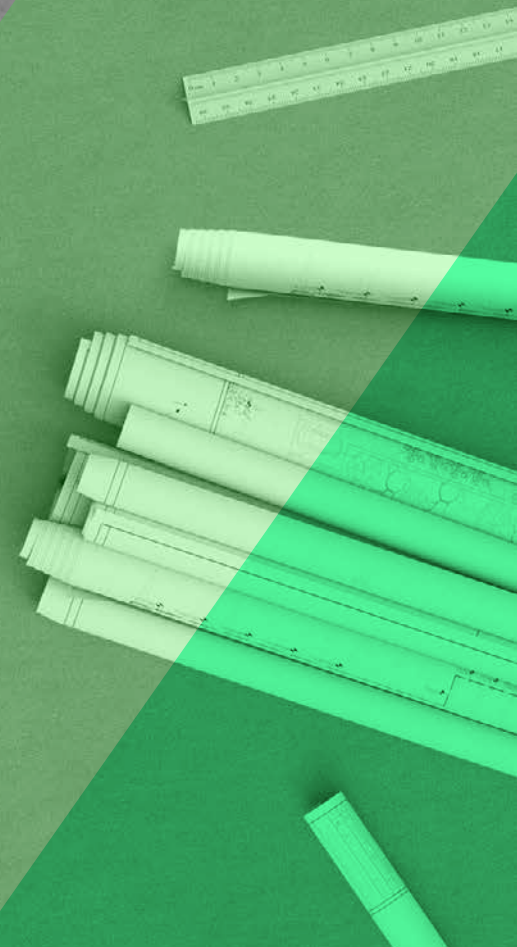
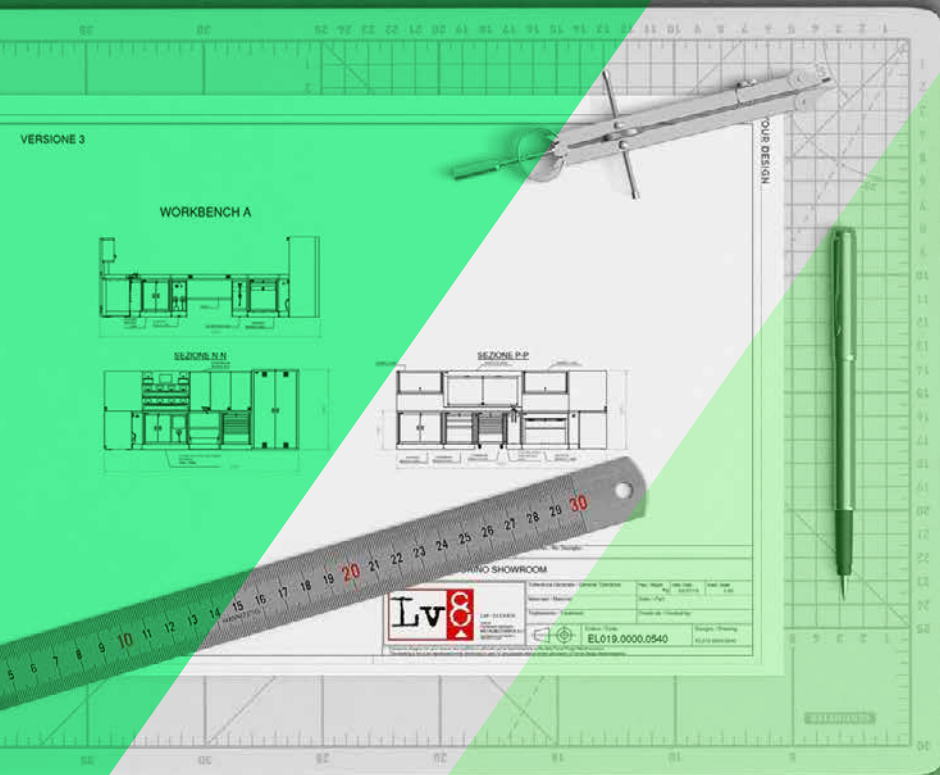

Tailor made workshop furniture



step 1 Planimetry, technical inspection and sharing of the brief

step 2 Development and realization of 2d technical table

step 3 Realization of 3D rendering and project definition

step 4 Delivery, assembly instructions or direct installation



LV8 ELEVATE designs, manufactures and sells technical workshop furniture.

The LV8 product range is designed and produced with certified high quality materials and components, 100% Made in Italy.

Thanks to the partnership between Fervi and LV8 it is possible to create customized workshop furnishings; contact us: we will study together the ideal configuration for your workshop!

P40VD

€ 7,90

FOOTBOARDS

MOUNTABLE POLYPROPYLENE, GREEN DRAINING SELF LOCKING FOOTBOARD

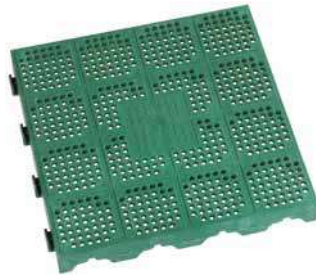

Overall sizes 400 x 400 x 48 mm
Pcs. - Pallet 120 = 20 m2

PSV-F

€ 5,70

POLYPROPYLENE SLIDE

MOUNTABLE FOR FOOTBOARDS, GREEN, FEMALE (WITHOUT HOOKS)

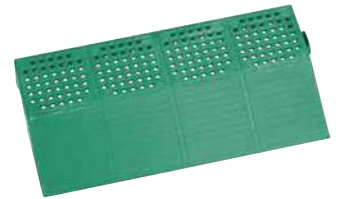

Overall sizes 205 x 400 x 48 mm

PSV-M

€ 5,70

POLYPROPYLENE SLIDE

MOUNTABLE FOR FOOTBOARDS, GREEN, MALE (WITH HOOKS)

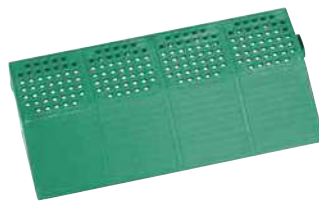

Overall sizes 205 x 400 x 48 mm

PAV

€ 8,00

CORNER SLIDES

FOR MOUNTABLE POLYPROPYLENE FOOTBOARDS, KIT OF 4 GREEN CORNER SLIDES

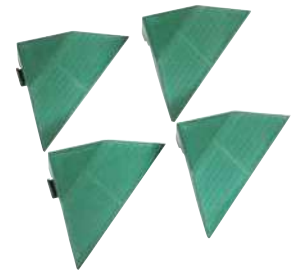

Overall sizes 200 x 200 x 270 x 48 mm

B019

€ 433,00

FOLDABLE HEAVY DUTY WORKBENCH

MADE OF STEEL, TEAR DOWN STRUCTURE WITH 2 POWERFUL GAS STRUTS, PEG BOARD 1195 X 458 X 20 mm, MAIN LEG HEIGHT 1380 mm, TOTAL WIDTH FOR THE PRODUCT 1280 mm, DEPTH OF THE OPEN/CLOSE PRODUCT 648/130 mm AT A HEIGHT OF 330 mm, AUTO-LOCK WITH HANDLE IN THE CORNER OF TOP PLATE, PEG BOARD WITH HOLES Ø 4 mm, DISTANCE BETWEEN CENTERS HOLES 25 mm FOR HOOKS WITH WIRE Ø 3 mm



Table dimensions 1195 x 648 x 41 mm
Capacity 225 kg
Weight 47 kg
Packing dimensions 1420 x 705 x 170 mm

B019/G030

€ 9,10

HOOK SET



10 Pcs

Length 30 mm
Pins center distance 25 mm

B015

€ 433,00

STEEL WORKBENCH KIT



Bench dimensions	1500 x 645 x 865h mm
Legs thickness	1,0 mm
Plate thickness	2 mm
Capacity	800 kg
Drawers with lock	2
Weight	69,5 kg

B015/10

€ 242,00

WORKBENCH KIT

WITH STEEL TOP AND LOCKABLE DRAWER



Overall sizes	1000 x 640 x 865h mm
Legs thickness	2 mm
Plate thickness	2 mm
Capacity	600 kg
Weight	44 kg

B022/10

€ 283,00

WORKBENCH KIT

WITH WOOD PRESS TOP AND A LOCKABLE DRAWER



Overall sizes	1000 x 640 x 865h mm
Legs thickness	2 mm
Plate thickness	38 mm
Capacity	350 kg
Weight	47 kg

B022/15

€ 408,00

WORKBENCH KIT

WITH WOOD PRESS TOP AND 2 LOCKABLE DRAWERS



Overall sizes	1500 x 640 x 865h mm
Legs thickness	2 mm
Plate thickness	38 mm
Capacity	350 kg
Weight	63 kg

B017

€ 288,00

WORKBENCH KIT



Bench dimensions	1524 x 650 x 845h mm
Legs thickness	1,0 mm
Plate thickness	40 mm
Weight	42,5 kg

B017/C

€ 58,30

DRAWER RACK WITH LOCK

ON BALL BEARING MADE OF STEEL, SUITABLE TO BENCHES OF OTHER BRANDS



Overall dimensions	680 x 270 x 130 mm
Internal dimensions	640 x 260 x 90 mm
Capacity	18,5 kg
Weight	4,3 kg



B009/A1

€ 408,00

WORKBENCH KIT

WITH WOOD PRESS TOP, 3 LOCKABLE DRAWERS, 1 SHELF AND ADJUSTABLE FEET



Overall sizes	1200 x 600 x 865h mm
Legs thickness	2 mm
Plate thickness	36 mm
Capacity	300 kg
Weight	62 kg

B009/B1

€ 475,00

WORKBENCH KIT

WITH WOOD PRESS TOP, 3 LOCKABLE DRAWERS, 1 SHELF WITH DOOR AND ADJUSTABLE FEET



Overall sizes	1200 x 600 x 865h mm
Legs thickness	2 mm
Plate thickness	36 mm
Capacity	300 kg
Weight	64,5 kg

B009/A2

CAT 42 € 642,00

WORKBENCH KIT

WITH WOOD PRESS TOP, 3 LOCKABLE DRAWERS, 1 DOOR AND SHELF AND ADJUSTABLE FEET



Dimensions	1690 x 600 x 865 mm
Legs thickness	2 mm
Plate thickness	36 mm
Capacity	300 kg
Weight	89 kg

B009/B2

CAT 42 € 675,00

WORKBENCH KIT

WITH WOOD PRESS TOP, 3 LOCKABLE DRAWERS, 2 SHELVES WITH DOOR AND ADJUSTABLE FEET



Dimensions	1690 x 600 x 865 mm
Legs thickness	2 mm
Plate thickness	36 mm
Capacity	300 kg
Weight	93 kg

P009

€ 151,00

WALLCABINET KIT

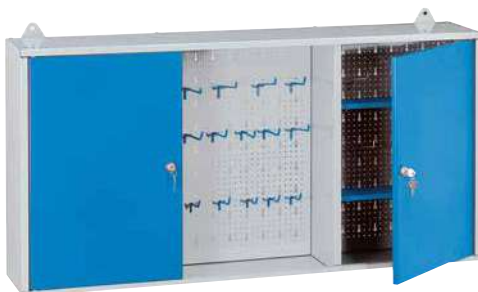

Cabinet dimensions	1200 x 200 x 600h mm
Steel thickness	0,8 mm
Internal shelves	4
Hooks	18 (6 + 6 + 6)
Weight	18 kg

Gx

HOOKS SET



10 Pcs

Art.	€	Pins center distance	Length
G050	€ 9,10	30 mm	80 mm
G130	€ 12,70	30 mm	155 mm

A100

€ 217,00

CABINET

WITH 1 DRAWER, SLIDE ON BEARING WITH LOCKING DEVICE



Cabinet dimensions	500 x 460 x 1000h mm
Steel thickness	1 mm
Internal shelves	2
Weight	35 kg

C800

€ 748,00

TOOL CABINET

WITH 8 DRAWERS, SLIDE ON BEARING WITH LOCKING DEVICE, WITHOUT INTERNAL DIVIDERS



Drawer capacity	50 kg
External Dimensions	630 x 550 x 930h mm
8 drawers A type internal dimensions	517 x 440 x 73h mm
Weight	61 kg

C600

€ 604,00

TOOL CABINET

WITH 6 DRAWERS, SLIDE ON BEARING WITH LOCKING DEVICE, WITHOUT INTERNAL DIVIDERS



Drawer capacity	50 kg
External Dimensions	630 x 550 x 930h mm
6 drawers B type internal dimensions	517 x 440 x 115h mm
Weight	56 kg

A300

€ 348,00

CABINET

WITH 2 DRAWERS, SLIDE ON BALL BEARING WITH LOCKING DEVICE



Cabinet dimensions	1000 x 460 x 1000h mm
Steel thickness	1 mm
Internal shelves	2
Weight	66 kg

C800-

"A" DRAWER DIVIDERS

EXAMPLE DIVIDERS SETTING



10 Pcs

Art.	€	Longitudinal divider	Transversal divider	Set pc
C800/CC	€ 44,80	440 x 70h mm	-	10
C800/LL	€ 49,30	-	517 x 70h mm	10

C600-

"B" DRAWER DIVIDERS

EXAMPLE DIVIDERS SETTING



10 Pcs

Art.	€	Longitudinal divider	Transversal divider	Set pc
C600/C	€ 97,50	440 x 110h mm	-	10
C600/L	€ 22,40	-	120 x 110h mm	10

C603

€ 727,00

TOOL CABINET

WITH 6 DRAWERS, SLIDE ON BEARING WITH LOCKING DEVICE, WITHOUT INTERNAL DIVIDERS



Drawer capacity	50 kg
External Dimensions	630 x 550 x 930h mm
3 drawers A type internal dimensions	517 x 440 x 73h mm
2 drawers B type internal dimensions	517 x 440 x 115h mm
1 drawer C type internal dimensions	517 x 440 x 175h mm
Weight	53,5 kg



C080-

DRAWER UNITS WITH TRANSPARENT PULL-OUT DRAWERS



Art.	€	External Dimensions	Drawer dimensions	Drawers number
C080/3	€ 48,20	382 x 290 x 230h mm	372 x 285 x 73h mm	3
C080/6	€ 47,90	382 x 290 x 230h mm	184 x 285 x 73h mm	6
C080/9	€ 48,80	382 x 290 x 230h mm	122 x 285 x 73h mm	9

C085-

DRAWER UNITS WITH TRANSPARENT PULL-OUT DRAWERS



Art.	€	External Dimensions	Drawer dimensions	Drawers number
C085/12	€ 29,20	382 x 148 x 230h mm	122 x 145 x 55h mm	12
C085/16	€ 29,20	382 x 148 x 230h mm	90 x 145 x 55h mm	16
C085/24	€ 32,90	382 x 148 x 230h mm	59 x 145 x 55h mm	24

C603-

"C" DRAWER DIVIDERS

EXAMPLE DIVIDERS SETTING

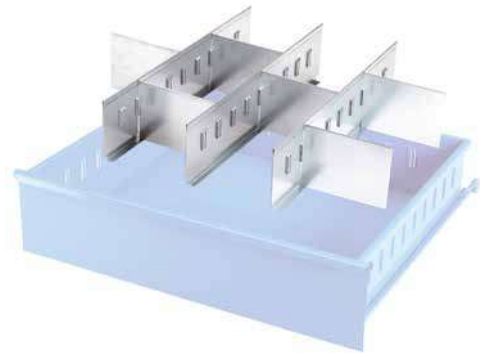

10 Pcs

Art.	€	Longitudinal divider	Transversal divider	Set pc
C603/C	€ 128,00	440 x 165h mm	-	10
C603/L	€ 26,80	-	120 x 165h mm	10

C700

€ 488,00

STEEL STORAGE CHEST WITH PLASTIC CASES

LOWER BOX WITH KEY LOCK AND UPPER ZONE WITH 7 TOOL BOXES WITH CENTRAL LOCK 4 PCS C360 + 3 PCS C371



Overall sizes	490 x 343 x 987h mm
Total weight	27 kg



MODULAR DRAWERS

CONNECTABLE WITH OTHER DRAWERS THROUGH GUIDES TO CREATE INFINITE COMBINATIONS. EQUIPPED WITH DRAWER LOCKING TO PREVENT THE CONTENTS FROM ACCIDENTALLY FALLING AND REAR FIXING HOLES FOR WALL MOUNTING. MADE OF RESISTANT PLASTIC, IT IS SUITABLE FOR USE IN THE CONSTRUCTION SITE, AT HOME AND IN THE WORKSHOP.

C086/01C

CAT 42 € 13,30

MODULAR DRAWER UNIT WITH PULL-OUT DRAWERS



Dimensions	300 x 200 x 165 mm
Drawers number	1
Drawer dimensions	250 x 130 x 150 mm
Weight	0.86 kg

C086/01T

CAT 42 € 13,30

MODULAR DRAWER UNIT WITH PULL-OUT TRAYS



Dimensions	300 x 200 x 165 mm
Drawers number	1
Drawer dimensions	250 x 160 x 150 mm
Weight	0.93 kg

C086/02C

CAT 42 € 15,00

MODULAR DRAWER UNIT WITH PULL-OUT DRAWERS



Dimensions	300 x 200 x 165 mm
Drawers number	2
Drawer dimensions	250 x 160 x 70 mm
Weight	0.94 kg

C086/02T

CAT 42 € 15,40

MODULAR DRAWER UNIT WITH PULL-OUT TRAYS



Dimensions	300 x 200 x 165 mm
Drawers number	2
Drawer dimensions	250 x 160 x 70 mm
Weight	0.99 kg

C086/04C

CAT 42 € 15,80

MODULAR DRAWER UNIT WITH PULL-OUT DRAWERS



Dimensions	300 x 200 x 165 mm
Drawers number	4
Drawer dimensions	120 x 160 x 70 mm
Weight	1.02 kg

C086/04T

CAT 42 € 17,50

MODULAR DRAWER UNIT WITH PULL-OUT TRAYS



Dimensions	300 x 200 x 165 mm
Drawers number	4
Drawer dimensions	120 x 160 x 70 mm
Weight	1.10 kg

C086/12C

CAT 42 € 18,30

MODULAR DRAWER UNIT WITH PULL-OUT DRAWERS



Dimensions	300 x 200 x 165 mm
Drawers number	12
Drawer dimensions	60 x 160 x 50 mm
Weight	1.16 kg



**C090-
UNIVERSAL STORAGE BIN**



Art.	€	Dimensions
C090/2	€ 2,10	108 x 167 x 75h mm
C090/3	€ 4,17	151 x 237 x 126h mm
C090/4	€ 9,30	213 x 350 x 164h mm
C090/5	€ 15,40	310 x 490 x 190h mm
C090/6	€ 31,00	380 x 610 x 250h mm

C087 € 180,00

TOOL ROLLING CABINET

METAL + ABS



Overall sizes	560 x 350 x 770h mm
Packing dimensions	585 x 365 x 775h mm
Weight	14 kg

C081 € 166,00
2 IN 1 TOOL ROLLING BOX



2 Pcs

Small tool box dimensions With 2 movable trays	610 x 375 x 415h mm
big tool box dimensions	750 x 487 x 493h mm
Packing dimensions	750 x 495 x 500h mm
Weight	18 kg

C087 € 180,00 **0849 € 189,00**

ALLUMINUM CASE SET



3 Pcs

Cases dimensions	730 x 380 x 360h mm - 680 x 310 x 320h mm - 475 x 260 x 210h mm
Weight	15 kg

**0382-
3 PC ALUMINUM CASE SET**



Art.	€	External Dimensions	Internal dimensions	Weight
0382/02	€ 142,00	760 x 335 x 250h mm	710 x 285 x 225h mm	5,5 kg
0382/03	€ 242,00	1240 x 385 x 385h mm	1185 x 335 x 365h mm	14 kg
0382/04	€ 429,00	1445 x 520 x 460h mm	1395 x 435 x 440h mm	21,5 kg
0382	€ 792,00	760 x 335 x 250h mm, 1240 x 385 x 385h mm, 1445 x 520 x 460h mm	710 x 285 x 225h mm, 1185 x 335 x 365h mm, 1395 x 435 x 440h mm	41 kg

**0363-
3 PC STEEL CASE SET**



Art.	€	External Dimensions	Internal dimensions	Weight
0363/30	€ 150,00	770x420x305h mm	750 x 400 x 300h mm	14,5 kg
0363/36	€ 192,00	915 x 440 x 565h mm	825 x 350 x 430h mm	35 kg
0363/48	€ 542,00	1220 x 620 x 700h mm	1130 x 520 x 600h mm	57,5 kg
0363	€ 825,00	770 x 420 x 305h mm, 915 x 440 x 565h mm, 1220 x 620 x 700h mm	750 x 400 x 300h mm, 825 x 350 x 430h mm, 1130 x 520 x 600h mm	107 kg

C670

€ 925,00

TOOL ROLLING CABINET

COMPOSED OF 6 BALL BEARING DRAWERS, 1 LARGE STORAGE WITH DOOR COMPARTMENT AND 2 DRAWERS, 2 SWIVEL AND 2 FIXED CASTERS, PAPER-ROLL DISPENSER EQUIPPED



Overall sizes	1200 x 460 x 1060h mm
Table dimensions	1020 x 455 x 15h mm
Cabinet dimensions	320 x 410 x 630h mm
Cabinet drawers	n°2 290 x 400 x 65h mm
Drawer dimensions	1) 900 x 405 x 85h mm
Drawer dimensions	2) 535 x 405 x 40h mm
Drawer dimensions	3) 535 x 405 x 70h mm
Drawer dimensions	4) 535 x 405 x 70h mm
Drawer dimensions	5) 535 x 405 x 150h mm
Drawer dimensions	6) 535 x 405 x 230h mm
Drawer capacity	25 kg
Weight	97 kg

C660

€ 727,00

TOOL ROLLING CABINET

COMPOSED OF 5 BALL BEARING DRAWERS, 1 LARGE STORAGE WITH DOOR COMPARTMENT, 2 SWIVEL AND 2 FIXED CASTERS, PAPER-ROLL DISPENSER EQUIPPED



Overall sizes	1170 x 475 x 850h mm
Plate Dimensions	1060 x 460 x 15h mm
Cabinet dimensions	320 x 445 x 560h mm
Internal shelf	410 x 410 mm
Drawer dimensions	1) 570 x 405 x 65h mm
Drawer dimensions	2) 570 x 405 x 65h mm
Drawer dimensions	3) 570 x 405 x 65h mm
Drawer dimensions	4) 570 x 405 x 145h mm
Drawer dimensions	5) 570 x 405 x 145h mm
Drawer capacity	25 kg
Weight	80 kg

C980

€ 817,00

TOOL ROLLING CABINET

7 DRAWERS, WITH 2 SIDE STORAGE COMPARTMENTS, BALL BEARING EQUIPPED DRAWERS WITH CENTRAL LOCK, 12 HOOKS AND 10 PLASTIC BINS INCLUDED, 2 SWIVEL AND 2 FIXED CASTERS



3 drawers	565 x 405 x 50h mm
3 drawers	565 x 405 x 105h mm
1 drawer	565 x 405 x 165h mm
Drawer capacity	25 kg
Tool cabinet size	890 x 530 x 1030h mm
Weight	101 kg

C980/G1

€ 5,40

HOOKS

HOOKS FOR THE TOOL ROLLING CABINET C980



5 Pcs Steel

Overall sizes 56 x 65 x 35 mm

C980/G2

€ 5,80

HOOKS

HOOKS FOR THE TOOL ROLLING CABINET C980



5 Pcs Steel

Overall sizes 56 x 65 x 35 mm

C980/G3

€ 7,50

HOOKS

HOOKS FOR THE TOOL ROLLING CABINET C980



5 Pcs Steel

Overall sizes 72 x 76 x 30 mm



C190

CAT 42 € 625,00

7 DRAWERS ROLLER CABINET

WITH ANTI-ROLLING SYSTEM. IT'S POSSIBLE TO OPEN ONLY ONE DRAWER AT ONE TIME; WORKTOP MADE OF PLASTIC AND WOOD WITH PRACTICAL COMPARTMENTS, RETRACTABLE SHELF AND INTEGRATED BOTH SIDE BOTTLES OR TOOL HOLDERS, SCREWDRIVERS COMPARTMENT



External Dimensions	1000 x 470 x 920h mm
2 Drawers	560 x 400 x 40h mm
4 Drawers	560 x 400 x 60h mm
1 drawer	560 x 400 x 170h mm
Weight	73 kg

C960/F6

CAT 42 € 425,00

TOOL ROLLING CABINET WITH 6 DRAWERS

BALL BEARING EQUIPPED SAFETY DRAWERS WITH CENTRAL LOCKING, PAPER DISPENSER AND TRAY, 2 SWIVEL AND 2 FIXED CASTERS



Dimensions	890 x 458 x 994 mm
Drawer dimensions	565 x 405 mm
Drawers height	3 x 74,5 mm - 3 x 153.5 mm
Drawer capacity	25 kg
Weight	65 kg

C960/F7

CAT 42 € 467,00

TOOL ROLLING CABINET WITH 7 DRAWERS

BALL BEARING EQUIPPED SAFETY DRAWERS WITH CENTRAL LOCKING, PAPER DISPENSER AND TRAY, 2 SWIVEL AND 2 FIXED CASTERS



Dimensions	890 x 458 x 994 mm
Drawer dimensions	565 x 405 mm
Drawers height	5 x 74,5 mm - 2 x 153.5 mm
Drawer capacity	25 kg
Weight	65 kg

C960/F8

CAT 42 € 508,00

TOOL ROLLING CABINET WITH 8 DRAWERS

BALL BEARING EQUIPPED SAFETY DRAWERS WITH CENTRAL LOCKING, PAPER DISPENSER AND TRAY, 2 SWIVEL AND 2 FIXED CASTERS



Dimensions	890 x 458 x 994 mm
Drawer dimensions	565 x 405 mm
Drawers height	7 x 74,5 mm - 1 x 153.5 mm
Drawer capacity	25 kg
Weight	66 kg

C960/B6

CAT 42 € 425,00

TOOL ROLLING CABINET WITH 6 DRAWERS

BALL BEARING EQUIPPED SAFETY DRAWERS WITH CENTRAL LOCKING, PAPER DISPENSER AND TRAY, 2 SWIVEL AND 2 FIXED CASTERS



Dimensions	890 x 458 x 994 mm
Drawer dimensions	565 x 405 mm
Drawers height	3 x 74,5 mm - 3 x 153.5 mm
Drawer capacity	25 kg
Weight	65 kg

C960/B7

CAT 42 € 467,00

TOOL ROLLING CABINET WITH 7 DRAWERS

BALL BEARING EQUIPPED SAFETY DRAWERS WITH CENTRAL LOCKING, PAPER DISPENSER AND TRAY, 2 SWIVEL AND 2 FIXED CASTERS



Dimensions	890 x 458 x 994 mm
Drawer dimensions	565 x 405 mm
Drawers height	5 x 74,5 mm - 2 x 153.5 mm
Drawer capacity	25 kg
Weight	65 kg

C960/B8

CAT 42 € 508,00

TOOL ROLLING CABINET WITH 8 DRAWERS

BALL BEARING EQUIPPED SAFETY DRAWERS WITH CENTRAL LOCKING, PAPER DISPENSER AND TRAY, 2 SWIVEL AND 2 FIXED CASTERS



Dimensions	890 x 458 x 994 mm
Drawer dimensions	565 x 405 mm
Drawers height	7 x 74,5 mm - 1 x 153.5 mm
Drawer capacity	25 kg
Weight	66 kg

C900/A

€ 225,00

TOOL CHEST

WITH 6 DRAWERS WITH CENTRAL LOCK AND PORTABLE TRAY



Overall sizes	660 x 322 x 380h mm
3 drawers	174 x 285 x 45h mm
2 Drawers	580 x 285 x 45h mm
1 drawer	580 x 285 x 70h mm
Weight	23 kg



C900/B

€ 346,00

TOOL ROLLING CABINET

COMPOSED OF 6 DRAWERS WITH CENTRAL LOCKING, 2 SWIVEL AND 2 FIXED CASTERS



Overall sizes	685 x 455 x 850h mm
2 Drawers	585 x 410 x 45 mm
2 Drawers	585 x 410 x 100 mm
2 Drawers	585 x 410 x 150 mm
Drawer capacity	25 kg
Weight	48 kg

C902/B

€ 276,00

TOOL ROLLING CABINET

COMPOSED OF 3 DRAWERS ROLL-WAGON WITH CENTRAL LOCKING, 2 SWIVEL AND 2 FIXED CASTERS



Compartment dimensions	575 x 430 x 315h mm
Overall sizes	680 x 435 x 780h mm
Drawer capacity	25 kg
Weight	27 kg



C655

€ 533,00

TOOL ROLLING CABINET

COMPOSED OF 3 DRAWER ROLL-WAGON WITH CENTRAL LOCKING, 2 SWIVEL AND 2 FIXED CASTERS



Overall dimensions	748 x 520 x 850h mm
Compartment dimensions	680 x 420 x 260 mm
Opening	485 x 390 mm
Drawer capacity	25 kg
Weight	54 kg

C190C

€ 1060,00

7 DRAWERS ROLLER CABINET WITH TOOLS

WITH 152 TOOLS, WITH ANTI-ROLLING SYSTEM. IT'S POSSIBLE TO OPEN ONLY ONE DRAWER AT ONE TIME; WORKTOP MADE OF PLASTIC AND WOOD WITH PRACTICAL COMPARTMENTS, RETRACTABLE SHELF AND INTEGRATED BOTH SIDE BOTTLES OR TOOL HOLDERS, SCREWDRIVERS COMPARTMENT



📦 152 Pcs

External Dimensions	1000 x 470 x 920h mm
2 Drawers	560 x 400 x 40h mm
4 Drawers	560 x 400 x 60h mm
1 drawer	560 x 400 x 170h mm
Weight	80 kg

C960C

€ 832,00

TOOL ROLLING CABINET WITH TOOLS

WITH TOOL SET: C960/1 - C960/2 C960/3 - C960/4 C960/5 - C960/6 C960/7 - C960/8



📦 291 Pcs

Dimensions	890 x 458 x 994 mm
Drawer dimensions	565 x 405 mm
Drawers height	5 x 74,5 mm - 2 x 153.5 mm
Drawer capacity	25 kg



C960/BE01

€ 1020,00

TOOL ROLLING CABINET WITH TOOLS

TOOL ROLLING CABINET WITH TOOLS WITH TOOL SET: TM01/004, TM01/007, TM01/013, TM01/015, TM01/017, TM01/019, TM01/039, TM01/040, TM01/041

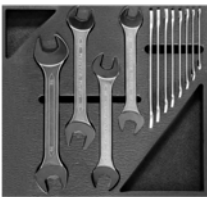
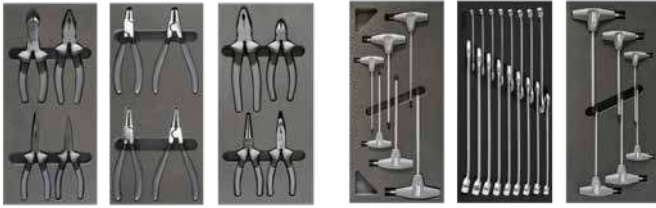

67 Pcs

Included foam trays	TM01/004, TM01/007, TM01/013, TM01/015, TM01/017, TM01/019, TM01/039, TM01/040, TM01/041
Tool cabinet size	890 x 475 x 1015h mm
5 Drawers	565 x 405 x 65h mm
2 Drawers	565 x 405 x 145h mm
Drawer capacity	25 kg
Weight	65 kg (empty)

C900/BE01

€ 788,00

TOOL ROLLING CABINET WITH TOOLS

TOOL ROLLING CABINET WITH TOOLS WITH TOOL SET: TM01/004, TM01/007, TM01/013, TM01/015, TM01/021, TM01/040, TM01/041

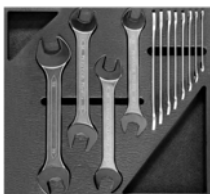

57 Pcs

Included foam trays	TM01/004, TM01/007, TM01/013, TM01/015, TM01/021, TM01/040, TM01/041
Tool cabinet size	685 x 455 x 850h mm
2 Drawers	585 x 410 x 45 mm
2 Drawers	585 x 410 x 100 mm
2 Drawers	585 x 410 x 150 mm
Drawer capacity	25 kg
Weight	48 kg (empty)

C900/BE02

€ 683,00

TOOL ROLLING CABINET WITH TOOLS

TOOL ROLLING CABINET WITH TOOLS WITH TOOL SET: TM01/004, TM01/007, TM01/013, TM01/015, TM01/021, TM01/040, TM01/041

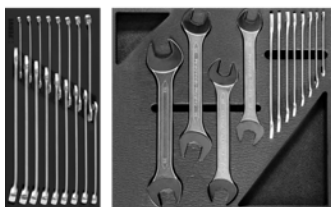

45 Pcs

Included foam trays	TM01/004, TM01/007, TM01/021, TM01/040, TM01/041
Tool cabinet size	685 x 455 x 850h mm
2 Drawers	585 x 410 x 45 mm
2 Drawers	585 x 410 x 100 mm
2 Drawers	585 x 410 x 150 mm
Drawer capacity	25 kg
Weight	48 kg (empty)

C960/AM01

CAT 42 € 958,00

TOOL ROLLING CABINET WITH AUTOMOTIVE TOOLS



142 Pcs

Tool cabinet size	890 x 475 x 1015h mm
5 Drawers	565 x 405 x 65h mm
2 Drawers	565 x 405 x 145h mm
Drawer capacity	25 kg
Weight	65 kg (empty)

C960/CC01

€ 958,00

TOOL ROLLING CABINET WITH TOOLS

TOOL ROLLING CABINET WITH TOOLS WITH TOOL SET: TM01/002, TM01/010, TM01/012, TM01/014, TM01/016, TM01/018, TM01/023, TM01/025, TM01/030, TM01/033, TM01/042.



159 Pcs

Included foam trays	TM01/002, TM01/010, TM01/012, TM01/014, TM01/016, TM01/018, TM01/023, TM01/025, TM01/030, TM01/033, TM01/042
Tool cabinet size	890 x 475 x 1015h mm
5 Drawers	565 x 405 x 65h mm
2 Drawers	565 x 405 x 145h mm
Drawer capacity	25 kg
Weight	65 kg (empty)

C900/CC01

€ 583,00

TOOL ROLLING CABINET WITH TOOLS

TOOL ROLLING CABINET WITH TOOLS WITH TOOL SET: TM01/001, TM01/012, TM01/014, TM01/020, TM01/022, TM01/024, TM01/042.

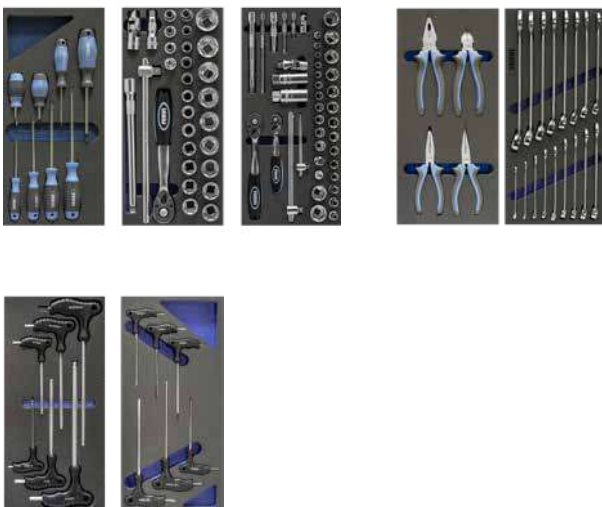

113 Pcs

Included foam trays	TM01/001, TM01/012, TM01/014, TM01/020, TM01/022, TM01/024, TM01/042
Tool cabinet size	685 x 455 x 850h mm
2 Drawers	585 x 410 x 45 mm
2 Drawers	585 x 410 x 100 mm
2 Drawers	585 x 410 x 150 mm
Drawer capacity	25 kg
Weight	48 kg (empty)

C980/CC01

€ 1370,00

TOOL ROLLING CABINET WITH TOOLS

TOOL ROLLING CABINET WITH TOOLS WITH TOOL SET: TM01/002, TM01/005, TM01/008, TM01/009, TM01/020, TM01/029, TM01/042.

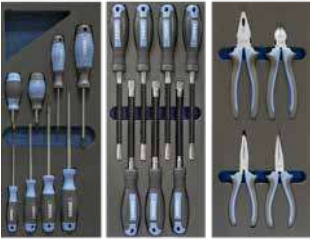

72 Pcs

Included foam trays	TM01/002, TM01/005, TM01/008, TM01/009, TM01/020, TM01/029, TM01/042
Tool cabinet size	890 x 530 x 1030h mm
3 drawers	565 x 405 x 50h mm
3 drawers	565 x 405 x 105h mm
1 drawer	565 x 405 x 165h mm
Drawer capacity	25 kg
Weight	101 kg (empty)



TM01/001

€ 49,20

COMBINATION SPANNER SET IN FOAM TRAY

POLYETHYLENE FOAM TRAY WITH 4 LAYERS IN 2 COLOURS: GREY-BLUE MILLED WITH A CNC MACHINE WITH A SET OF TOOLS



Overall sizes	188 x 405 x 33 mm
Sizes	6 - 7 - 8 - 9 - 10 - 11 - 12 - 13 - 14 - 15 - 16 - 17 - 18 - 19 - 20 - 21 - 22 mm
Included items	0224/..

TM01/002

€ 101,00

COMBINATION SPANNER SET IN FOAM TRAY

POLYETHYLENE FOAM TRAY WITH 4 LAYERS IN 2 COLOURS: GREY-BLUE MILLED WITH A CNC MACHINE WITH A SET OF TOOLS



Overall sizes	188 x 405 x 33 mm
Sizes	6 - 7 - 8 - 9 - 10 - 11 - 12 - 13 - 14 - 15 - 16 - 17 - 18 - 19 - 20 - 21 - 22 mm
Included items	0208/..

TM01/004

€ 99,20

COMBINATION SPANNER SET IN FOAM TRAY

POLYETHYLENE FOAM TRAY WITH 4 LAYERS IN 2 COLOURS: GREY-BLACK MILLED WITH A CNC MACHINE WITH A SET OF TOOLS

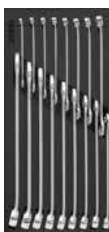

Overall sizes	188 x 405 x 33 mm
Sizes	6 - 7 - 8 - 9 - 10 - 11 - 12 - 13 - 14 - 15 - 16 - 17 - 18 - 19 - 20 - 21 - 22 mm
Included items	BE11/..

TM01/005

€ 51,70

OPEN END WRENCHES SET IN FOAM TRAY

POLYETHYLENE FOAM TRAY WITH 4 LAYERS IN 2 COLOURS: GREY-BLUE MILLED WITH A CNC MACHINE WITH A SET OF TOOLS



Overall sizes	376 x 405 x 33 mm
Sizes	6x7 - 8x9 - 10x11 - 12x13 - 14x15 - 16x17 - 18x19 - 20x22 - 21x23 - 24x26 - 25x28 - 30x32 mm
Included items	0222/..

TM01/006

€ 78,30

OPEN END WRENCHES SET IN FOAM TRAY

POLYETHYLENE FOAM TRAY WITH 4 LAYERS IN 2 COLOURS: GREY-BLUE MILLED WITH A CNC MACHINE WITH A SET OF TOOLS



Overall sizes	376 x 405 x 33 mm
Sizes	6x7 - 8x9 - 10x11 - 12x13 - 14x15 - 16x17 - 18x19 - 20x22 - 21x23 - 24x26 - 25x28 - 30x32 mm
Included items	0201/..

TM01/007

€ 90,00

OPEN END WRENCHES SET IN FOAM TRAY

POLYETHYLENE FOAM TRAY WITH 4 LAYERS IN 2 COLOURS: GREY-BLACK MILLED WITH A CNC MACHINE WITH A SET OF TOOLS

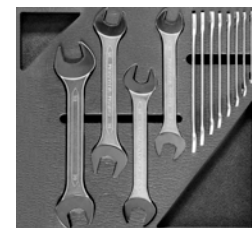

Overall sizes	376 x 405 x 33 mm
Sizes	6x7 - 8x9 - 10x11 - 12x13 - 14x15 - 16x17 - 18x19 - 20x22 - 21x23 - 24x26 - 25x28 - 30x32 mm
Included items	BE10/..

TM01/008

€ 136,00

MALE T-HANDLE HEX WRENCH SET IN FOAM TRAY

POLYETHYLENE FOAM TRAY WITH 4 LAYERS IN 2 COLOURS: GREY-BLUE MILLED WITH A CNC MACHINE WITH A SET OF TOOLS



Overall sizes	376 x 405 x 33 mm
Sizes	2 - 3 - 4 - 5 - 6 - 7 - 8 - 9 - 10 - 12 - 14 mm
Included items	0400/..

TM01/009

€ 140,00

MALE T-HANDLE TORX WRENCH SET IN FOAM TRAY

POLYETHYLENE FOAM TRAY WITH 4 LAYERS IN 2 COLOURS: GREY-BLUE MILLED WITH A CNC MACHINE WITH A SET OF TOOLS



Overall sizes	188 x 405 x 33 mm
Sizes	T6 - T7 - T8 - T9 - T10 - T15 - T20 - T25 - T27 - T30 - T40 - T45 - T50 mm
Included items	0405/..

TM01/010

€ 213,00

T HANDLE MAGNETIC SWIVEL HEX SOCKET SET IN FOAM TRAY

POLYETHYLENE FOAM TRAY WITH 4 LAYERS IN 2 COLOURS: GREY-BLUE MILLED WITH A CNC MACHINE WITH A SET OF TOOLS



26 Pcs

Overall sizes	565 x 405 x 33 mm
T handle	7 - 8 - 10 - 12 - 13 - 14 - 17 - 19 mm
Hex keys	1,5 - 2 - 2,5 - 3 - 4 - 5 - 6 - 8 - 10 mm
Torx Keys	T10 - T15 - T20 - T25 - T27 - T30 - T40 - T45 - T50
Included items	C395/.. - 0215 - 0220

TM01/011

€ 235,00

T HANDLE MAGNETIC SWIVEL HEX SOCKET SET IN FOAM TRAY

POLYETHYLENE FOAM TRAY WITH 4 LAYERS IN 2 COLOURS: GREY-BLUE MILLED WITH A CNC MACHINE WITH A SET OF TOOLS



26 Pcs

Overall sizes	565 x 405 x 33 mm
T handle	7 - 8 - 10 - 12 - 13 - 14 - 17 - 19 mm
Hex keys	1,5 - 2 - 2,5 - 3 - 4 - 5 - 6 - 8 - 10 mm
Torx Keys	T10 - T15 - T20 - T25 - T27 - T30 - T40 - T45 - T50
Included items	C391/.. - 0215 - 0220

TM01/012

€ 39,20

TWO WAY HEX KEY WITH ANATOMIC PLASTIC HANDLE SET IN FOAM TRAY

POLYETHYLENE FOAM TRAY WITH 4 LAYERS IN 2 COLOURS: GREY-BLUE MILLED WITH A CNC MACHINE WITH A SET OF TOOLS



6 Pcs

Overall sizes	188 x 405 x 33 mm
Sizes	3 - 4 - 5 - 6 - 8 mm
Included items	0856/..

TM01/013

€ 46,70

SET OF HEXAGONAL HEAD SCREWDRIVERS WITH T-HANDLE IN FOAM TRAY

POLYETHYLENE FOAM TRAY WITH 4 LAYERS IN 2 COLOURS: GREY-BLACK MILLED WITH A CNC MACHINE WITH A SET OF TOOLS



6 Pcs

Overall sizes	188 x 405 x 33 mm
Sizes	3 - 4 - 5 - 6 - 8 - 10 mm
Included items	BE20/..

TM01/014

€ 39,20

TWO WAY TORX KEY WITH ANATOMIC PLASTIC HANDLE SET IN FOAM TRAY

POLYETHYLENE FOAM TRAY WITH 4 LAYERS IN 2 COLOURS: GREY-BLUE MILLED WITH A CNC MACHINE WITH A SET OF TOOLS



6 Pcs

Overall sizes	188 x 405 x 33 mm
Sizes	T10 - T15 - T20 - T25 - T30 - T40 mm
Included items	0855/..

TM01/015

€ 61,70

SET OF TORX HEAD SCREWDRIVERS WITH T-HANDLE IN FOAM TRAY

POLYETHYLENE FOAM TRAY WITH 4 LAYERS IN 2 COLOURS: GREY-BLACK MILLED WITH A CNC MACHINE WITH A SET OF TOOLS



6 Pcs

Overall sizes	188 x 405 x 33 mm
Sizes	T15 - T20 - T25 - T27 - T30 - T40 mm
Included items	BE21/..

TM01/016

€ 34,20

FLAT SCREWDRIVER SET IN FOAM TRAY

POLYETHYLENE FOAM TRAY WITH 4 LAYERS IN 2 COLOURS: GREY-BLUE MILLED WITH A CNC MACHINE WITH A SET OF TOOLS



8 Pcs

Overall sizes	188 x 405 x 33 mm
Slotted screwdriver	3 x 75 - 4 x 100 - 5 x 125 - 6 x 150 - 8 x 150 - 6 x 38 mm
Electrician screwdriver	3 x 75 - 4 x 100 mm
Included items	C883/.. - C884/..

TM01/017

€ 46,70

FLAT SCREWDRIVER SET IN FOAM TRAY

POLYETHYLENE FOAM TRAY WITH 4 LAYERS IN 2 COLOURS: GREY-BLACK MILLED WITH A CNC MACHINE WITH A SET OF TOOLS



7 Pcs

Overall sizes	188 x 405 x 33 mm
Sizes	2,5 x 75 - 3,0 x 100 - 4,0 x 125 - 5,5 x 150 - 6,5 x 150 - 8,0 x 175 - 4,0 x 25 mm
Included items	BE50/..



TM01/018

CROSSTIP SCREWDRIVER SET IN FOAM TRAY

POLYETHYLENE FOAM TRAY WITH 4 LAYERS IN 2 COLOURS: GREY-BLUE MILLED WITH A CNC MACHINE WITH A SET OF TOOLS

€ 39,20



Overall sizes	188 x 405 x 33 mm
Cross screwdriver	PH 1 x 75 - PH 2 x 100 - PH 3 x 150 - PH 2 x 38 mm
Cross screwdriver	PZ 1 x 75 - PZ 2 x 100 - PZ 3 x 150 - PZ 2 x 38 mm
Included items	C882/.. - C885/..

TM01/020

MIXED SCREWDRIVER SET IN FOAM TRAY

POLYETHYLENE FOAM TRAY WITH 4 LAYERS IN 2 COLOURS: GREY-BLUE MILLED WITH A CNC MACHINE WITH A SET OF TOOLS

€ 35,00



Overall sizes	188 x 405 x 33 mm
Slotted screwdriver	3 x 75 - 4 x 100 - 5 x 125 - 6 x 150 - 6 x 38 mm
Cross screwdriver	PH 1 x 75 - PH 2 x 100 - PH 2 x 38 mm
Included items	C882/.. - C884/..

TM01/044

FLAT SCREWDRIVER SET WITH DIAMOND TIP IN FOAM TRAY

POLYETHYLENE FOAM TRAY WITH 4 LAYERS IN 2 COLOURS: GREY-BLUE MILLED WITH A CNC MACHINE WITH A SET OF TOOLS

CAT 42 € 43,10



Overall sizes	188 x 405 x 33 mm
Slotted screwdriver	4 x 75 - 4 x 100 - 5 x 125 - 6 x 150 - 8 x 150 - 6 x 38 mm
Electrician screwdriver	3 x 75 - 4 x 100 mm
Included items	D883/.. - D884/..

TM01/046

MIXED SCREWDRIVER SET WITH DIAMOND TIP IN FOAM TRAY

POLYETHYLENE FOAM TRAY WITH 4 LAYERS IN 2 COLOURS: GREY-BLUE MILLED WITH A CNC MACHINE WITH A SET OF TOOLS

CAT 42 € 43,60



Overall sizes	188 x 405 x 33 mm
Slotted screwdriver	3 x 75 - 4 x 100 - 5 x 125 - 6 x 150 - 6 x 38 mm
Cross screwdriver	PH 1 x 75 - PH 2 x 100 - PH 2 x 38 mm
Included items	D882/.. - D884/..

TM01/019

CROSSTIP SCREWDRIVER SET IN FOAM TRAY

POLYETHYLENE FOAM TRAY WITH 4 LAYERS IN 2 COLOURS: GREY-BLACK MILLED WITH A CNC MACHINE WITH A SET OF TOOLS

€ 48,30



Overall sizes	188 x 405 x 33 mm
Sizes	PH 0 x 60 - PH 1 x 80 - PH 2 x 100 - PH 3 x 150 - PH 2 x 25 - PZ 1 x 80 - PZ 2 x 100 mm
Included items	BE51/.. - BE52/..

TM01/021

MIXED SCREWDRIVER SET IN FOAM TRAY

POLYETHYLENE FOAM TRAY WITH 4 LAYERS IN 2 COLOURS: GREY-BLACK MILLED WITH A CNC MACHINE WITH A SET OF TOOLS

€ 51,70



Overall sizes	188 x 405 x 33 mm
Slotted screwdriver	3,0 x 100 - 4,0 x 125 - 5,5 x 150 - 6,5 x 150 mm
Cross screwdriver	PH 0 x 60 - PH 1 x 80 - PH 2 x 100 mm
Cross screwdriver	PZ 2 x 100 mm
Included items	BE50/.. - BE51/.. - BE52/..

TM01/045

CROSSTIP SCREWDRIVER SET WITH DIAMOND TIP IN FOAM TRAY

POLYETHYLENE FOAM TRAY WITH 4 LAYERS IN 2 COLOURS: GREY-BLUE MILLED WITH A CNC MACHINE WITH A SET OF TOOLS

CAT 42 € 48,70



Overall sizes	188 x 405 x 33 mm
Cross screwdriver	PH 1 x 75 - PH 2 x 100 - PH 3 x 150 - PH 2 x 38 mm
Cross screwdriver	PZ 1 x 75 - PZ 2 x 100 - PZ 3 x 150 - PZ 2 x 38 mm
Included items	D882/.. - D885/..

TM01/022

HEXAGONAL HAND SOCKET SET IN FOAM TRAY

POLYETHYLENE FOAM TRAY WITH 4 LAYERS IN 2 COLOURS: GREY-BLUE MILLED WITH A CNC MACHINE WITH A SET OF TOOLS

€ 186,00



Overall sizes	188 x 405 x 33 mm
Socket	8 - 9 - 10 - 11 - 12 - 13 - 14 - 15 - 16 - 17 - 18 - 19 - 20 - 21 - 22 - 23 - 24 - 25 - 26 - 27 - 28 - 29 - 30 - 32 mm
Included items	BN4E3N0.. - CN450N1/2A

TM01/023

€ 182,00

BI-HEXAGONAL HAND SOCKET SET IN FOAM TRAY

POLYETHYLENE FOAM TRAY WITH 4 LAYERS IN 2 COLOURS: GREY-BLUE MILLED WITH A CNC MACHINE WITH A SET OF TOOLS



Overall sizes	188 x 405 x 33 mm
Socket	8 - 9 - 10 - 11 - 12 - 13 - 14 - 15 - 16 - 17 - 18 - 19 - 20 - 21 - 22 - 23 - 24 - 25 - 26 - 27 - 28 - 29 - 30 - 32 mm
Included items	BN4P3N0.. - CN450N1/2A

TM01/024

€ 189,00

HEXAGONAL HAND SOCKET SET IN FOAM TRAY

POLYETHYLENE FOAM TRAY WITH 4 LAYERS IN 2 COLOURS: GREY-BLUE MILLED WITH A CNC MACHINE WITH A SET OF TOOLS



Overall sizes	188 x 405 x 33 mm
1/4" Dr. sockets	4 - 5 - 6 - 7 - 8 - 9 - 10 - 11 - 12 - 13 - 14 mm
3/8" Dr. sockets	7 - 8 - 9 - 10 - 11 - 12 - 13 - 14 - 15 - 16 - 17 - 18 - 19 - 20 - 21 - 22 mm
Included items	BN4E5N0.. - BN4E4N0.. - CN450N1/4A - CN450N3/8A - JN40., - LN400N., - PN405N.. - PN404N.. - BN4C4L..

TM01/025

€ 185,00

BI-HEXAGONAL HAND SOCKET SET IN FOAM TRAY

POLYETHYLENE FOAM TRAY WITH 4 LAYERS IN 2 COLOURS: GREY-BLUE MILLED WITH A CNC MACHINE WITH A SET OF TOOLS



Overall sizes	188 x 405 x 33 mm
1/4" Dr. sockets	4 - 5 - 6 - 7 - 8 - 9 - 10 - 11 - 12 - 13 - 14 mm
3/8" Dr. sockets	7 - 8 - 9 - 10 - 11 - 12 - 13 - 14 - 15 - 16 - 17 - 18 - 19 - 20 - 21 - 22 mm
Included items	BN4P5N0.. - BN4P4N0.. - CN450N1/4A - CN450N3/8A - JN40., - LN400N., - PN405N.. - PN404N.. - BN4C4L..

TM01/026

€ 37,50

INSULATED SCREWDRIVER SET IN FOAM TRAY

POLYETHYLENE FOAM TRAY WITH 4 LAYERS IN 2 COLOURS: GREY-BLUE MILLED WITH A CNC MACHINE WITH A SET OF TOOLS



Overall sizes	188 x 405 x 33 mm
Slotted insulated screwdriver	3 x 100 - 4 x 100 - 5,5 x 125 - 6,5 x 150 mm
Cross insulated screwdriver	PH 0 x 60 - PH 1 x 80 - PH 2 x 100 mm
Included items	CI82/.. - CI83/.. - 0013/142

TM01/027

€ 50,00

NUT DRIVER SET IN FOAM TRAY

POLYETHYLENE FOAM TRAY WITH 4 LAYERS IN 2 COLOURS: GREY-BLUE MILLED WITH A CNC MACHINE WITH A SET OF TOOLS



Overall sizes	188 x 405 x 33 mm
Sizes	5,5 - 6 - 7 - 8 - 10 - 12 - 13 mm
Included items	CB01/..

TM01/028

€ 60,00

NUT DRIVER SET IN FOAM TRAY

POLYETHYLENE FOAM TRAY WITH 4 LAYERS IN 2 COLOURS: GREY-BLUE MILLED WITH A CNC MACHINE WITH A SET OF TOOLS



Overall sizes	188 x 405 x 33 mm
Sizes	5,5 - 6 - 7 - 8 - 10 - 12 - 13 mm
Included items	CB02/..

TM01/029

€ 57,50

FLEXIBLE NUT DRIVER SET IN FOAM TRAY

POLYETHYLENE FOAM TRAY WITH 4 LAYERS IN 2 COLOURS: GREY-BLUE MILLED WITH A CNC MACHINE WITH A SET OF TOOLS



Overall sizes	188 x 405 x 33 mm
Sizes	5,5 - 6 - 7 - 8 - 10 - 12 - 13 mm
Included items	CBF1/..
Overall sizes	188 x 405 x 33 mm
Sizes	ø2x140 - ø3x150 - ø4x180 - ø5x220 - ø6x210 - ø7x210 - ø8x220 mm
Included items	C015/..

TM01/030

€ 36,70

RING SPANNER SET IN FOAM TRAY

POLYETHYLENE FOAM TRAY WITH 4 LAYERS IN 2 COLOURS: GREY-BLUE MILLED WITH A CNC MACHINE WITH A SET OF TOOLS



Overall sizes	188 x 405 x 33 mm
Sizes	6x7 - 8x9 - 10x11 - 12x13 - 14x15 - 16x17 - 18x19 - 20x22 mm
Included items	0476/..



TM01/031

€ 43,30

RING SPANNER SET IN FOAM TRAY

POLYETHYLENE FOAM TRAY WITH 4 LAYERS IN 2 COLOURS: GREY-BLUE MILLED WITH A CNC MACHINE WITH A SET OF TOOLS



4 Pcs Cr-V Chromed DIN 838

Overall sizes	188 x 405 x 33 mm
Sizes	21x23 - 24x27 - 25x28 - 30x32 mm
Included items	0476/..

TM01/032

€ 43,30

COMBINATION SPANNER SET IN FOAM TRAY

POLYETHYLENE FOAM TRAY WITH 4 LAYERS IN 2 COLOURS: GREY-BLUE MILLED WITH A CNC MACHINE WITH A SET OF TOOLS



4 Pcs Cr-V DIN 3113

Overall sizes	188 x 405 x 33 mm
Sizes	24 - 27 - 30 - 32 mm
Included items	0224/..

TM01/033

€ 60,80

COMBINATION SPANNER SET IN FOAM TRAY

POLYETHYLENE FOAM TRAY WITH 4 LAYERS IN 2 COLOURS: GREY-BLUE MILLED WITH A CNC MACHINE WITH A SET OF TOOLS



4 Pcs Cr-V Chromed DIN 3113

Overall sizes	188 x 405 x 33 mm
Sizes	24 - 27 - 30 - 32 mm
Included items	0208/..

TM01/035

€ 116,00

HEXAGONAL TUBULAR SOCKET AND FLARE NUT WRENCH SET IN FOAM TRAY

POLYETHYLENE FOAM TRAY WITH 4 LAYERS IN 2 COLOURS: GREY-BLUE MILLED WITH A CNC MACHINE WITH A SET OF TOOLS



16 Pcs Cr-V

Overall sizes	188 x 405 x 33 mm
Tubular sockets	6x7 - 8x9 - 10x11 - 12x13 - 14x15 - 16x17 - 18x19 - 20x22 mm
Flare nit wrenches	100 - 6x7, 115 - 8x9, 130 - 10x11, 145 - 12x13, 160 - 14x15, 170 - 16x17, 185 - 18x19 - 205 - 20x22 mm
Included items	0442/.. - 01345

TM01/036

€ 65,80

HEXAGONAL TUBULAR SOCKET AND FLARE NUT WRENCH SET IN FOAM TRAY

POLYETHYLENE FOAM TRAY WITH 4 LAYERS IN 2 COLOURS: GREY-BLUE MILLED WITH A CNC MACHINE WITH A SET OF TOOLS



17 Pcs

Overall sizes	188 x 405 x 33 mm
Tubular sockets	6x7 - 8x9 - 10x11 - 12x13 - 14x15 - 16x17 - 18x19 - 20x22 mm
Flare nit wrenches	100 - 6x7, 115 - 8x9, 130 - 10x11, 145 - 12x13, 160 - 14x15, 170 - 16x17, 185 - 18x19 - 205 - 20x22 mm
Included items	0540/.. - 01345

TM01/037

€ 68,30

DRIFT PIN SET IN FOAM TRAY

POLYETHYLENE FOAM TRAY WITH 4 LAYERS IN 2 COLOURS: GREY-BLUE MILLED WITH A CNC MACHINE WITH A SET OF TOOLS



7 Pcs Cr-Mo

Sizes	ø2x140 - ø3x150 - ø4x180 - ø5x220 - ø6x210 - ø7x210 - ø8x220 mm
Included items	C015/..

TM01/038

€ 78,30

DRIFT PIN SET WITH HAMMER IN FOAM TRAY

POLYETHYLENE FOAM TRAY WITH 4 LAYERS IN 2 COLOURS: GREY-BLUE MILLED WITH A CNC MACHINE WITH A SET OF TOOLS



12 Pcs Cr-Mo

Overall sizes	188 x 405 x 33 mm
Pin punch	ø2x150 - ø3x150 - ø4x150 - ø5x150 - ø6x150 - ø7x150 - ø8x150 mm
Center punches	4x120 - 5x150 mm
Chisel	18x150 - 21x200 - 25x250 mm
German hammer	400g
Included items	C012/.. - B006/.. - S022/.. - 0154/400DIN

TM01/039

€ 66,70

PLIER SET IN FOAM TRAY

POLYETHYLENE FOAM TRAY WITH 4 LAYERS IN 2 COLOURS: GREY-BLACK MILLED WITH A CNC MACHINE WITH A SET OF TOOLS



4 Pcs Cr-V Chromed

Overall sizes	188 x 405 x 33 mm
Combination plier	180 mm
Heavy duty diagonal cutting nippers	180 mm
Long nose pliers	170 mm
Long flat nose pliers	160 mm
Included items	BE30/18 - BE32/18 - BE33/17 - BE35/16

TM01/040

€ 76,70

LOCK RING PLIER SET IN FOAM TRAY

POLYETHYLENE FOAM TRAY WITH 4 LAYERS IN 2 COLOURS: GREY-BLACK MILLED WITH A CNC MACHINE WITH A SET OF TOOLS



Overall sizes	188 x 405 x 33 mm
Straight external lock ring pliers	180 mm
Bent external lock rings pliers	180 mm
Straight internal lock ring pliers	180 mm
Bent internal lock ring pliers	180 mm
Included items	BE37/03 - BE38/03 - BE39/03 - BE40/03

TM01/041

€ 66,70

PLIER SET IN FOAM TRAY

POLYETHYLENE FOAM TRAY WITH 4 LAYERS IN 2 COLOURS: GREY-BLACK MILLED WITH A CNC MACHINE WITH A SET OF TOOLS



Overall sizes	188 x 405 x 33 mm
Combination plier	200 mm
Diagonal cutting nippers	160 mm
Bent long nose pliers	170 mm
Long round nose pliers	160 mm
Included items	BE30/20 - BE31/16 - BE34/17 - BE36/16

TM01/042

€ 36,70

PLIER SET IN FOAM TRAY

POLYETHYLENE FOAM TRAY WITH 4 LAYERS IN 2 COLOURS: GREY-BLUE MILLED WITH A CNC MACHINE WITH A SET OF TOOLS



Overall sizes	188 x 405 x 33 mm
Combination plier	180 mm
Diagonal cutting nippers	160 mm
Bent long nose pliers	160 mm
Long nose pliers	160 mm
Included items	0873/U7 - 0873/BD6 - 0873/BC6 - 0873/TL

TM01/043

€ 157,00

HEXAGONAL IMPACT SOCKET SET IN FOAM TRAY

POLYETHYLENE FOAM TRAY WITH 4 LAYERS IN 2 COLOURS: GREY-BLUE MILLED WITH A CNC MACHINE WITH A SET OF TOOLS



Overall sizes	188 x 405 x 33 mm
Socket	10 - 11 - 12 - 13 - 14 - 16 - 17 - 18 - 19 - 21 - 22 - 23 - 24 mm
Extension bars	75 - 150 - 250 mm
Included items	BI4E3N.. - PI453..

TM01/050

CAT 42 € 458,00

MEASURING INSTRUMENTS FOR AUTOMOTIV IN FOAM TRAY

POLYETHYLENE FOAM TRAY WITH 4 LAYERS IN 2 COLOURS: GREY-BLUE MILLED WITH A CNC MACHINE WITH A SET OF TOOLS



Overall sizes	565 x 405 x 33 mm
Included items	C033/150 - C004 - 0212 - C058 - F685 - T053 - 0446 - C070 - 0312

TM01/052

CAT 42 € 428,00

PNEUMATIC SERIES FOR AUTOMOTIVE IN FOAM TRAY

POLYETHYLENE FOAM TRAY WITH 4 LAYERS IN 2 COLOURS: GREY-BLUE MILLED WITH A CNC MACHINE WITH A SET OF TOOLS



Overall sizes	565 x 405 x 33 mm
Included items	AP03 - BI4E3Nx - PI453150 - 0341 - JI403N - 0608

TM01/053

CAT 42 € 219,00

ADDITIONAL TOOLS SERIES FOR AUTOMOTIVE IN FOAM TRAY

POLYETHYLENE FOAM TRAY WITH 4 LAYERS IN 2 COLOURS: GREY-BLUE MILLED WITH A CNC MACHINE WITH A SET OF TOOLS



Overall sizes	565 x 405 x 33 mm
Included items	L002/250 - 0136 - 0370/8 - 0368/10 - 0432 - 0209

TM01/100

€ 16,70

EMPTY FOAM TRAY FOR SMALL ITEMS

POLYETHYLENE FOAM TRAY WITH 4 LAYERS IN 2 COLOURS: GREY-BLUE MILLED WITH A CNC MACHINE



Overall sizes	188 x 405 x 33 mm
---------------	-------------------



TM01/110

€ 25,00

EMPTY FOAM TRAY FOR SMALL ITEMS

POLYETHYLENE FOAM TRAY WITH 4 LAYERS IN 2 COLOURS: GREY-BLUE MILLED WITH A CNC MACHINE

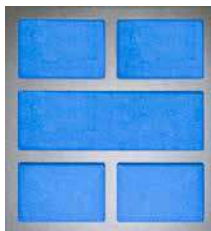

Overall sizes 376 x 405 x 33 mm

TM01/120

€ 33,30

EMPTY FOAM TRAY FOR SMALL ITEMS

POLYETHYLENE FOAM TRAY WITH 4 LAYERS IN 2 COLOURS: GREY-BLUE MILLED WITH A CNC MACHINE



Overall sizes 564 x 405 x 33 mm

0466/4V

€ 28,00

MAGNETIC TOOL TRAY SET

MADE OF PAINTED STEEL, TO ORGANIZE THE BEST WORKING PLACE



4 Pcs

Overall dimensions 310 x 130 x 120h mm; 270 x 130 x 120h mm; 210 x 130 x 120h mm; 150 x 130 x 120h mm
Capacity 1,17 kg; 1 kg; 0,77 kg; 0,6 kg
Steel thickness 0,7 mm
Weight 3 kg

0466/C

€ 6,70

MAGNETIC SCREWDRIVERS HOLDER

MADE OF PAINTED STEEL, TO ORGANIZE THE BEST WORKING PLACE



Overall dimensions 280 x 60 x 60h mm
Screwdrivers 9
Holes 5 x ø 9 mm; 4 x ø 8 mm
Steel thickness 1,5 mm

0466/CV

€ 11,70

MAGNETIC HANGING TRAY WITH SCREWDRIVERS HOLDER

MADE OF PAINTED STEEL, TO ORGANIZE THE BEST WORKING PLACE



Dimensions 360 x 130 x 110h mm
Drawer dimensions 305 x 115 x 30h mm
Holes 6 x ø 10 mm
Capacity 3.18 kg
Steel thickness 1 mm
Weight 1 kg

0466/PB

€ 6,70

MAGNETIC SOCKETS HOLDER

MADE OF PAINTED STEEL, TO ORGANIZE THE BEST WORKING PLACE



Overall dimensions 280 x 45 x 90h mm
Sockets sizes 1/4" - 3/8" - 1/2"
Steel thickness 0,9 mm

0466/SA

€ 18,30

MAGNETIC HOLDER FOR IMPACT WRENCH

MADE OF PAINTED STEEL, TO ORGANIZE THE BEST WORKING PLACE



Overall dimensions 130 x 120 x 400h mm
Hole diameter 80 mm
Capacity 9 kg
Weight 1,3 kg

0466/SC

€ 13,30

3 HOLE MAGNETIC SPRAY CANS AND 7 SCREWDRIVERS HOLDER

MADE OF PAINTED STEEL, TO ORGANIZE THE BEST WORKING PLACE



Overall dimensions 130 x 300 x 130h mm
Holes 3 x ø 75 mm; 2 x ø 12 mm; 1 x ø 11 mm; 1 x ø 10 mm; 1 x ø 9 mm; 2 x ø 7,5 mm
Capacity 1,19 kg
Steel thickness 0,8 mm
Weight 1,25 kg

0105T

CAT 42 € 258,00

TOOL TROLLEY WITH ACCESSORIES



162 Pcs Cr-V

Ball point hex key	1,5-2-2,5-3-4-5-6-8-10 mm
Screwdrivers	(-) 5 x 75 - 6 x 100 mm - (+) 1 x 75 - 2 x 100 mm
Electric tester	100 ÷ 250 V
Precision screwdrivers	(-) 2 x 140 - 2,4 x 140 - 3 x 140 - (+) 00 x 140 mm - 0 x 140 mm
Pliers	160 mm
Adjustable wrench	200 mm
Diagonal cutting nippers	160 mm
Long nose pliers	160 mm
Tower pincers	220 mm
Multipurpose scissors	175 mm
Punches and chisel	5
Snap ring pliers with 3 heads	1
Water pump pliers	240 mm
Combination spanner	8-10-11-12-13-15-17-19-21 mm
1/4" Dr. sockets	4-4,5-5-5,5-6-7-8-9-10-11-12-13-14 mm
1/2" Dr. sockets	12-13-14-15-16-17-18-19-21-24-27-30-32 mm
Sliding T-bar	1/4"
Universal joint	1/4" - 1/2"
1/4" Dr. socket-bars	50 mm - 100 mm
1/2" Dr. socket-bars	125 mm - 250 mm

3 way joint	1
Spark plug sockets sizes	16 mm - 21 mm
Ratchet handles	1/4" - 1/2"
File	200 mm
German hammer	300 g
Precision tape	5 m
Mini hacksaw	1
Blades	3
Aluminum flashlight	1
Crimping pliers	200 mm
Terminals	35
Utility knife	1
Level	300 mm
Vernier caliper	150 mm
Magnetic bit holder	1
Bits	30 - 1/4"
Ratchet bit handle	1
Male adapter 1/4" Dr. and 1/4" hex	1
Case size	470 x 350 x 135 mm
Weight	12 kg

0110T

CAT 42 € 218,00

TOOL BOX WITH TROLLEY, TOOLS AND ACCESSORIES



133 Pcs Cr-V

Ball point hex key	1,5-2-2,5-3-4-5-6-8 mm
Screwdrivers	(-) 3 x 75 - 5 x 75 - 6 x 100 - 8 x 150 mm - (+) 0 x 75 - 1 x 75 - 2 x 100 3 x 100 mm
Precision screwdrivers	(-) 2,4 x 140 - (+) 00 x 140 mm - 0 x 140 mm
Pliers	180 mm
Slip joint pliers	150 mm
Diagonal cutting nippers	115 mm
Long nose pliers	150 mm
Wire stripper plier	160 mm
Scissors	200 mm
Water pump pliers	240 mm
Combination spanner	6-8-10-13-14-15-17-19 mm
1/4" Dr. sockets	4-5-6-7-8-9-10-11-12-13-14 mm
1/2" Dr. sockets	8-9-10-11-12-13-14-15-16-17-18-19-20-21-22 mm
Sliding T-bar	1/4"
Universal joint	1/4" - 1/2"
1/4" Dr. socket-bars	100 mm
1/2" Dr. socket-bars	250 mm

3 way joint	1
Spark plug sockets sizes	16 mm - 21 mm
Ratchet handles	1/4" - 1/2"
Flexible bar	1/4" - 145 mm
Bits holder socket	1/4"
German hammer	300 g
Precision tape	5 m
Mini hacksaw	1
Terminals	20
Utility knife	1
Knives	5
Level	300 mm
Socket handle	1/4"
Magnetic bit holder	1/4"
Bits	30 - 1/4"
Male adapter 1/4" Dr. and 1/4" hex	1
Case size	470 x 350 x 135 mm
Weight	10 kg



0105

€ 220,00

TOOL BOX WITH ACCESSORIES



162 Pcs Cr-V

Ball point hex key	1,5-2-2,5-3-4-5-6-8-10 mm		
Screwdrivers	(-) 5 x 75 - 6 x 100 mm - (+) 1 x 75 - 2 x 100 mm		
Electric tester	100 ÷ 250 V		
Precision screwdrivers	(-) 2 x 140 - 2,4 x 140 - 3 x 140 - (+) 00 x 140 mm - 0 x 140 mm		
Pliers	160 mm		
Adjustable wrench	200 mm		
Diagonal cutting nippers	160 mm		
Long nose pliers	160 mm		
Tower pincers	220 mm		
Multipurpose scissors	175 mm		
Punches and chisel	5		
Snap ring pliers with 3 heads	1		
Water pump pliers	240 mm		
Combination spanner	8-10-11-12-13-15-17-19-21 mm		
1/4" Dr. sockets	4-4,5-5-5,5-6-7-8-9-10-11-12-13-14 mm		
1/2" Dr. sockets	12-13-14-15-16-17-18-19-21-24-27-30-32 mm		
Sliding T-bar	1/4"		
Universal joint	1/4" - 1/2"		
1/4" Dr. socket-bars	50 mm - 100 mm		
1/2" Dr. socket-bars	125 mm - 250 mm		
3 way joint		1	
Spark plug sockets sizes		16 mm - 21 mm	
Ratchet handles		1/4" - 1/2"	
File		200 mm	
German hammer		300 g	
Precision tape		5 m	
Mini hacksaw		1	
Blades		3	
Aluminum flashlight		1	
Crimping pliers		200 mm	
Terminals		35	
Utility knife		1	
Level		300 mm	
Vernier caliper		150 mm	
Magnetic bit holder		1	
Bits		30 - 1/4"	
Ratchet bit handle		1	
Male adapter 1/4" Dr. and 1/4" hex		1	
Case size		470 x 350 x 135 mm	
Weight		11,8 kg	

0110

€ 179,00

TOOL BOX WITH ACCESSORIES



133 Pcs Cr-V

Ball point hex key	1,5-2-2,5-3-4-5-6-8 mm		
Screwdrivers	(-) 3 x 75 - 5 x 75 - 6 x 100 - 8 x 150 mm - (+) 0 x 75 - 1 x 75 - 2 x 100 x 100 mm		
Precision screwdrivers	(-) 2,4 x 140 - (+) 00 x 140 mm - 0 x 140 mm		
Pliers	180 mm		
Slip joint pliers	150 mm		
Diagonal cutting nippers	115 mm		
Long nose pliers	150 mm		
Wire stripper plier	160 mm		
Scissors	200 mm		
Water pump pliers	240 mm		
Combination spanner	6-8-10-13-14-15-17-19 mm		
1/4" Dr. sockets	4-5-6-7-8-9-10-11-12-13-14 mm		
1/2" Dr. sockets	8-9-10-11-12-13-14-15-16-17-18-19-20-21-22 mm		
Sliding T-bar	1/4"		
Universal joint	1/4" - 1/2"		
1/4" Dr. socket-bars	100 mm		
1/2" Dr. socket-bars	250 mm		
3 way joint		1	
Spark plug sockets sizes		16 mm - 21 mm	
Ratchet handles		1/4" - 1/2"	
Flexible bar		1/4" - 145 mm	
Bits holder socket		1/4"	
German hammer		300 g	
Precision tape		5 m	
Mini hacksaw		1	
Terminals		20	
Utility knife		1	
Knives		5	
Level		300 mm	
Socket handle		1/4"	
Magnetic bit holder		1/4"	
Bits		30 - 1/4"	
Male adapter 1/4" Dr. and 1/4" hex		1	
Case size		470 x 350 x 135 mm	
Weight		9,8 kg	

0399

CAT 42 € 163,00

TOOL BOX WITH TOOLS AND ACCESSORIES

88 Pcs Cr-V

Gross weight	3,12 kg
Ball point hex key	2-2,5-3-4-5-6-8-10 mm
Screwdrivers	(-) 5 x 75 - 6 x 100 mm - (+) 1 x 75 - 2 x 100 mm
Pliers	150 mm
Adjustable wrench	250 mm
Diagonal cutting nippers	150 mm
Long nose pliers	150 mm
Multipurpose scissors	150 mm
Water pump pliers	240 mm
Combination spanner	8-10-11-12-13-15-17 mm
1/4" Dr. sockets	4-4,5-5-5,5-6-7-8-9-10-11-12-13-14 mm
1/2" Dr. sockets	10-13-14-15-16-17-19-21-22 mm
Sliding T-bar	1/4"
Universal joint	1/4" - 1/2"
1/4" Dr. socket-bars	50 mm - 100 mm
1/2" Dr. socket-bars	125 mm - 250 mm
3 way joint	1
Spark plug sockets sizes	16 mm - 21 mm
Ratchet handles	1/4" - 1/2"
German hammer	300 g
Utility knife	1
Magnetic bit holder	1
Bits	30 - 1/4"
Ratchet bit handle	1
Male adapter 1/4" Dr. and 1/4" hex	1
Case size	450 x 360 x 120 mm



0434

CAT 42 € 79,20

TOOL BOX WITH TOOLS AND ACCESSORIES

54 Pcs Cr-V

Gross weight	3,12 kg
Ball point hex key	1,5-2-2,5-3-4-5-6-8-10 mm
Screwdrivers	(-) 5 x 75 - 6 x 100 mm - (+) 1 x 75 - 2 x 100 mm
Pliers	150 mm
Adjustable wrench	200 mm
Long nose pliers	150 mm
Water pump pliers	240 mm
Spark plug sockets sizes	16 mm - 21 mm
German hammer	300 g
Utility knife	1
Magnetic bit holder	1
Bits	30 - 1/4"
Ratchet bit handle	1
Precision tape	5 m
Case size	400 x 270 x 120 mm



0165

€ 217,00

TOOL BOX WITH ACCESSORIES

WITH CART



175 Pcs Cr-V Blow mold case

Ratchet handles	1/4" - 1/2"	Precision tape	5 m
1 1/2" Dr. spark plug sockets	16 mm - 21 mm	Mini hacksaw	1
Gear Reduction ratio	1/2" (M) - 3/8" (F)	Magnetic level	250 mm
Ratchet bit handle	1/4"	Aluminum flashlight	1
1/4" Dr. sockets	4-4,5-5-5,5-6-7-8-9-10-11-12-13 mm	Crimping pliers	200 mm
Spinner handle	1/4"	Terminals	50
1/2" Dr. sockets	10-11-12-13-14-15-16-17-18-19-20-21-22 23-24-27-30 mm	Utility knife	1
Sliding bars	1/4" - 1/2"	Locking pliers	175 mm
1/4" Dr. socket-bars	50 - 100 mm	PVC tape	1
Universal joints	1/4" - 1/2"	Pickup tools with magnet	1
Flexible bar	1/4" - 150 mm	Vernier caliper	150 mm
Ball point long nose hex key	1,5-2-2,5-3-4-5-6-8-10 mm	Electrician screwdrivers	(-) 5 x 125 - 4 x 100 - (+) 3 x 75 mm
Electric tester	100 ÷ 250 V	Screwdrivers	(-) 3 x 75 - 3 x 100 - 5 x 75 - 6 x 38 - 6 x 100 mm (+) 3 x 75 - 3 x 100 - 5 x 75 - 6 x 38 - 6 x 100 - 8 x 150 mm
Precision screwdrivers	(-) 1 - 1,4 - 1,8 - 2,4 - (+) 0 - 1	Magnetic bit holder	1
Pliers	200 - 180 - 160 mm	Bits	25 1/4"
Adjustable wrench	200 mm	Plastic case size	500 x 440 x 200/270 mm trolley
Water pump pliers	250 mm	Trolley	1
Combination spanner	6-8-10-11-12-13-14-15-17-19 mm	Weight	15,5 kg
German hammer	300 g		

0315

€ 149,00

TOOL BOX WITH ACCESSORIES

132 Pcs Cr-V Blow mold case

Ball point hex key	1,5 - 2 - 2,5 - 3 - 4 - 5 - 6 - 8 - 10 mm	Terminals	50
Electric tester	100 ÷ 250 V	Utility knife	1
Precision screwdrivers	(-) 1 - 1,4 - 1,8 - 2,4 - (+) 0 - 1	Locking pliers	175 mm
Pliers	200 - 180 - 160 mm	PVC tape	1
Adjustable wrench	250 mm	Pickup tools with magnet	1
Water pump pliers	250 mm	Vernier caliper	150 mm
Combination spanner	6 - 8 - 10 - 11 - 12 - 13 - 14 - 15 - 17 - 19 mm	Electrician screwdrivers	(-) 5 x 125 - 4 x 100 - (+) 3 x 75 mm
German hammer	300 g	Screwdrivers	(-) 3 x 75 - 3 x 100 - 5 x 75 - 6 x 38 - 6 x 100 mm (+) 3 x 75 - 3 x 100 - 5 x 75 - 6 x 38 - 6 x 100 - 8 x 150 mm
Precision tape	5 m	Magnetic bit holder	1
Mini hacksaw	1	Bits	25 - 1/4"
Magnetic level	250 mm	Plastic case size	500 x 440 x 150 mm
Aluminum flashlight	1	Weight	9,5 kg
Crimping pliers	200 mm		

0323/45

€ 38,80

TOOL CHEST
WITH 5 TRAYS



Overall sizes 450 x 200 x 205h mm
Weight 4,2 kg

0323/55

€ 44,00

TOOL CHEST
WITH 5 TRAYS



Overall sizes 550 x 200 x 205h mm
Weight 4,8 kg

0423/1

€ 25,90

TOOL BOX

MADE OF METAL, WITH 16 SMALL AND 4 MIDDLE PLASTIC TRAYS, IDEAL FOR STORING SMALL PARTS. SMALL PLASTIC TRAYS DIMENSIONS: 54 X 52 X 43H mm, MIDDLE PLASTIC TRAYS DIMENSIONS: 54 X 105 X 43H mm. THE BOX HAS TWO SAFETY LOCKS TO PREVENT THE INVOLUNTARY OVERTHROW OF THE HARDWARE



Dimensions 334 x 240 x 45 mm
Weight 1,7 kg

0423/2

€ 30,60

TOOL BOX

MADE OF METAL, WITH 29 SMALL AND 3 MIDDLE PLASTIC TRAYS, IDEAL FOR STORING SMALL PARTS. SMALL PLASTIC TRAYS DIMENSIONS: 54 X 52 X 43H mm, MIDDLE PLASTIC TRAYS DIMENSIONS: 54 X 105 X 43H mm. THE BOX HAS A CENTRAL SAFETY LOCK TO PREVENT THE OVERTHROW OF THE HARDWARE



Dimensions 388 x 295 x 45 mm
Weight 1,9 kg

0422-

POLYPROPYLENE BLISTER SET

USEFUL FOR STORING SMALL ITEMS SUCH AS SCREWS, BOLTS, NUTS, SMALL HOOKS, NAILS



20 Pcs

Art.	€	Dimension
0422/B1	€ 7,30	65 x 47 x 30 mm
0422/B3	€ 12,70	75 x 60 x 40mm

C312

€ 6,70

TOOL ORGANIZER BOX

WITH 21 COMPARTMENTS AND MOVABLE DIVIDERS, FOR STORING LARGER ITEMS THAN THE ORIGINAL MAGAZINE



Plastic
Dimensions 320 x 260 x 50 mm
Weight 0,5 kg

C315

€ 10,40

TOOL ORGANIZER BOX

WITH 21 COMPARTMENTS AND MOVABLE DIVIDERS, FOR STORING LARGER ITEMS THAN THE ORIGINAL MAGAZINE



Plastic
Dimensions 380 x 310 x 60 mm
Weight 0,75 kg

C313

€ 58,30

RACK WITH 4 PLASTIC TOOL ORGANIZER BOXES

MODULAR, WITH 13 EXTRACTABLE CONTAINERS OF VARIOUS SIZES, EQUIPPED WITH LATERAL INSETS FOR STACKING AND REAR HOLES FOR WALL FIXING



Plastic
Dimensions 377 x 265 x 310 mm
Weight 4,7 kg



C360

€ 19,70

TOOL BOX

WITH 23 COMPARTMENTS AND 16 REMOVABLE DIVIDERS



Plastic

Overall sizes 443 x 317 x 80h mm

C371

€ 32,10

TOOL BOX

WITH 2 BIG TRAYS, 3 MEDIUM TRAYS, 6 SMALL TRAYS



Plastic

Dimensions 443 x 317 x 107h mm

C163

€ 12,10

TOOL-BOX

16", LOCKABLE, WITH 1 MOVABLE SHELF AND 2 COMPARTMENTS FOR MOTION WORK IN THE LID



Polypropylene

Overall sizes 394 x 160 x 195h mm

C165

€ 22,90

TOOL-BOX

20", WITH 1 MOVABLE SHELF AND 2 COMPARTMENTS FOR MOTION WORK IN THE LID



Polypropylene

Overall sizes 514 x 225 x 260h mm

0682

€ 77,90

ABS TOOL CASE

TOOLS NOT INCLUDED



A	460 mm	E	52 mm
B	330 mm	Capacity	25 kg
C	150 mm	Weight	2,9 kg
D	98 mm		

0683

€ 133,00

TROLLEY ABS TOOL CASE

TOOLS NOT INCLUDED



A	460 mm	E	92 mm
B	330 mm	Capacity	25 kg
C	190 mm	Weight	4,5 kg
D	98 mm		

C648

€ 44,40

TOOL BOX

WITH MOVABLE SHELF



Stainless steel - Polypropylene

Overall sizes 510 x 280 x 220h mm

M13x

WATER PROOF TOOL CASE

BUILT IN PRESSURE VALVE WITH CUBED-FOAM INTERIOR TO PROTECT THE OBJECT STORED. IT IS IDEAL FOR INSTRUMENTS AND TEST EQUIPMENT



Polypropylene

Art.	€	External Dimensions	Internal dimensions	Weight
M138	€ 52,80	465 x 360 x 175h mm	425 x 287 x 115h mm	2,9 kg
M139	€ 72,40	570 x 410 x 215h mm	505 x 353 x 140h mm	5,1 kg

M300/B

€ 70,80

WATERPROOF TOOL CASE

BUILT IN PRESSURE VALVE WITH CUBED-FOAM INTERIOR TO PROTECT THE OBJET STORED. THE SUPERIOR PROTECTION FROM THE ELEMENTS, WATER , DUST AND IMPACTS, MAKE IT SUITABLE FOR A WIDE ARRAY OF SECTORS AND APPLICAZIONI.



Polypropylene 67 STANAG 4280 DEF-STAN 81-41 *made in italy*

External Dimensions	336 x 300 x 148 mm
Internal dimensions	300 x 225 x 132 mm
Internal volume	8.91 l
Working temperature	-30 / 90°C (-22 / 194°F)
Weight	1.62 kg

M430/B

€ 95,80

WATERPROOF TOOL CASE

BUILT IN PRESSURE VALVE WITH CUBED-FOAM INTERIOR TO PROTECT THE OBJET STORED. THE SUPERIOR PROTECTION FROM THE ELEMENTS, WATER , DUST AND IMPACTS, MAKE IT SUITABLE FOR A WIDE ARRAY OF SECTORS AND APPLICAZIONI.



Polypropylene 67 STANAG 4280 DEF-STAN 81-41 *made in italy*

External Dimensions	464 x 366 x 176 mm
Internal dimensions	426 x 290 x 159 mm
Internal volume	19.64 l
Working temperature	-30 / 90°C (-22 / 194°F)
Weight	2.76 kg

M505/B

€ 146,00

WATERPROOF TOOL CASE

BUILT IN PRESSURE VALVE WITH CUBED-FOAM INTERIOR TO PROTECT THE OBJET STORED. THE SUPERIOR PROTECTION FROM THE ELEMENTS, WATER , DUST AND IMPACTS, MAKE IT SUITABLE FOR A WIDE ARRAY OF SECTORS AND APPLICAZIONI.



Polypropylene 67 STANAG 4280 DEF-STAN 81-41 *made in italy*

External Dimensions	555 x 428 x 211 mm
Internal dimensions	500 x 350 x 194 mm
Internal volume	33.95 l
Working temperature	-30 / 90°C (-22 / 194°F)
Weight	3.9 kg

M540/BT

€ 238,00

WATERPROOF TOOL CASE WITH TROLLEY

BUILT IN PRESSURE VALVE WITH CUBED-FOAM INTERIOR TO PROTECT THE OBJET STORED. THE SUPERIOR PROTECTION FROM THE ELEMENTS, WATER , DUST AND IMPACTS, MAKE IT SUITABLE FOR A WIDE ARRAY OF SECTORS AND APPLICAZIONI.



Polypropylene 67 DEF STAN 81-41 STANAG 4280 *made in italy*

External Dimensions	594 x 473 x 270 mm
Internal dimensions	538 x 405 x 245 mm
Internal volume	53.38 l
Working temperature	-30 / 90°C (-22 / 194°F)
Weight	5.2 kg

068x

ALUMINIUM TOOL CASE

TOOLS NOT INCLUDED

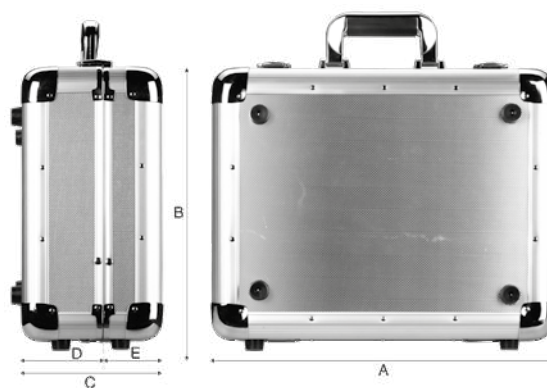

Art.	€	A	B	C	D	E	Capacity	Weight
0680	€ 108,00	510 mm	375 mm	185 mm	110 mm	75 mm	30 kg	5,8 kg
0681	€ 93,30	440 mm	390 mm	185 mm	110 mm	75 mm	30 kg	5,2 kg



0557

CAT 42 € 75,00

MULTITOOL BACKPACK

MADE IN POLYESTER 1680 DENIER, WITH HARD-RUBBER BASE, BREATHABLE BACK, EXTRACTABLE TOOL HOLDERS, LAPTOP PADDED POCKET WITH OFFICE ZONE, GREAT AND RUGGED POCKETS TO ACCOMMODATE A GREAT NUMBER OF TOOLS



External Dimensions 370 x 160 x 460h mm
Weight 2,5 kg

0395

€ 44,40

TOOL BAG

WITH SHOULDER BELT MADE OF 1680 DENIER POLYESTER



Pockets 19
Overall sizes 480 x 250 x 225h mm / 19" x 10" x 9" h
Weight 2 kg

0409

€ 9,30

TOOL BAG

10 POCKETS WITH BELT, MADE OF POLYESTER. IT CAN BE USED TO HOLD SMALL TESTER, PLIERS, SCISSORS, SCREWDRIVERS AND OTHER TOOLS



Dimensions 250 x 210 x 70 mm

0264

€ 14,00

FITTER TOOL BAG

LEATHER WITH BELT



Pockets 11

0390

€ 36,10

TOOL BAG

WITH SHOULDER BELT MADE OF 1680 DENIER POLYESTER



Pockets 14
Dimensions 400 x 225 x 250h mm - 16" x 9" x 10" h
Weight 1,6 kg

0408

€ 7,70

TOOL BAG

4 POCKETS, MADE OF POLYESTER, SUITABLE FOR ALL KIND OF BELT. IT CAN BE USED TO HOLD SMALL TESTER, PLIERS, SCISSORS, SCREWDRIVERS AND OTHER TOOLS



Dimensions 240 x 140 x 100 mm

0254

€ 6,90

FITTER TOOL BAG

LEATHER WITH BELT





Pockets 5







BENCH VICES, CLAMPS AND ANVILS

- pag.448*  — Bench vices
- pag.451*  — Vices
- pag.452*  — Anvils



PNEUMATIC

- pag.453*  — Staplers and brad nailers
- pag.455*  — Air impact wrenches
- pag.459*  — Air die grinders
- pag.461*  — Air belt sander
- pag.463*  — Air guns
- pag.465*  — Spray guns
- pag.468*  — Air hose reel



SOLDERINGS, HOT AIR GUNS AND GLUE GUNS

- pag.470*  — Solderings
- pag.471*  — Hot air guns
- pag.473*  — Glue guns









EQUIPMENT FOR LIQUIDS AND FLUIDS

- pag.474*  — Oilers
- pag.475*  — Greaser guns
- pag.476*  — Spray
- pag.479*  — Tanks
- pag.479*  — Pumps
- pag.480*  — Pressure sprayers







HEATERS, LIGHTING AND LENSES

- pag.482*  — Heaters
- pag.483*  — LED Lights
- pag.485*  — Lamps
- pag.486*  — Magnifier lens
- pag.487*  — Battery operated torches and lamps
- pag.492*  — Powers sockets
- pag.494*  — Generators





SAFETY AND PROTECTION

- pag.498*  — Gloves
- pag.502*  — Eyewear
- pag.502*  — First aid
- pag.505*  — Noise-protection headphones
- pag.506*  — Masks
- pag.507*  — Shoes and boots



CONSTRUCTION AND PACKAGING

- pag.495*  — Guns for chemicals
- pag.496*  — Trowels and putty knives
- pag.497*  — Packaging material



0036-
STEEL VICE



Art.	€	Jaw	Opening	Working height	Slot distance	Weight
0036/100	€ 96,10	100 mm	90 mm	60 mm	85 mm	4,9 kg
0036/125	€ 142,00	125 mm	138 mm	75 mm	110 mm	10 kg
0036/150	€ 240,00	150 mm	190 mm	90 mm	150 mm	19 kg

0135-
FORGED STEEL VICE
WITH SLIDE ADJUSTMENT



Art.	€	Jaws	Opening	Working height	Slot distance	Weight
0135/100	€ 103,00	100 mm	125 mm	60 mm	98 mm	5,8 kg
0135/125	€ 146,00	125 mm	160 mm	70 mm	111 mm	9,8 kg
0135/150	€ 232,00	150 mm	190 mm	85 mm	136 mm	17,8 kg

0591-
STEEL VICE
WITH BEARING ON SCREW, INTERCHANGEABLE JAWS AND PIPEJAWS



Art.	€	Jaw	Opening	Weight
0591/100	€ 127,00	100 mm	105 mm	6,1 kg
0591/125	€ 179,00	125 mm	138 mm	12,3 kg
0591/150	€ 270,00	150 mm	230 mm	26,6 kg

0036-xG
TABLE VICE WITH SWIVEL BASE



Art.	€	Jaw	Opening	Weight
0036/100G	€ 113,00	100 mm	90 mm	5 kg
0036/125G	€ 155,00	125 mm	138 mm	11 kg
0036/150G	€ 266,00	150 mm	190 mm	23 kg

0140-
STEEL VICE
HEAVY DUTY WITH PIPE JAWS AND SLIDE ADJUSTMENT



Art.	€	Jaws	Opening	Working height	Slot distance	Weight
0140/080	€ 38,60	80 mm	80 mm	60 mm	81 mm	4 kg
0140/100	€ 45,10	100 mm	100 mm	65 mm	81 mm	6,1 kg
0140/125	€ 66,50	125 mm	125 mm	90 mm	103 mm	10,9 kg
0140/150	€ 83,70	150 mm	150 mm	95 mm	123 mm	14,9 kg

0145-
STEEL VICE WITH PIPE JAW



Art.	€	Jaws	Opening	Working height	Slot distance	Weight
0145/80	€ 32,60	80 x 20 mm	80 mm	58 mm	76 mm	3,8 kg
0145/100	€ 36,20	100 x 20 mm	100 mm	70 mm	85 mm	5,5 kg
0145/125	€ 48,20	125 x 20 mm	125 mm	75 mm	90 mm	7,4 kg
0145/150	€ 78,40	150 x 27 mm	150 mm	95 mm	105 mm	12 kg

0174-

SG IRON BENCH VICE

WITH INTERCHANGEABLE JAWS



Art.	€	Jaws	Opening	Working height	Slot distance	Weight
0174/100	€ 51,50	100 x 20 mm	100 mm	50 mm	85 mm	4,8 kg
0174/125	€ 64,20	125 x 22 mm	130 mm	60 mm	95 mm	7,7 kg
0174/150	€ 80,30	150 x 22 mm	150 mm	75 mm	105 mm	10 kg

0427-

SG IRON PARALLEL BENCH VICE

WITH PRISMATIC GUIDES



Art.	€	Jaws	Opening	Weight
0427/080	€ 60,10	80 mm	80 mm	6,5 kg
0427/100	€ 77,50	100 mm	100 mm	10,1 kg
0427/125	€ 103,00	125 mm	125 mm	12,2 kg

0146/60

€ 21,20

STEEL VICE WITH SWIVEL BASE



Jaw	60 mm
Opening	50 mm
Clamp capacity	45 mm
Weight	2,3 kg

0042-

CAT 42

ALUMINIUM MAGNETIC JAW COUPLE



Art.	€	Jaw
0042/100	€ 10,70	100 mm
0042/125	€ 16,50	125 mm
0042/150	€ 16,90	150 mm

0520-xG

CAT 42

ALUMINIUM MAGNETIC JAW PAIR WITH RUBBER FACE



Aluminium 2 Pcs Double blister

Art.	€	Length	Height	Thickness
0520/100G	€ 11,90	100 mm	28,7 mm	10,0 mm
0520/125G	€ 13,50	125 mm	28,7 mm	10,0 mm
0520/150G	€ 15,00	150 mm	28,7 mm	10,0 mm

0520-xA

CAT 42

ALUMINIUM MAGNETIC JAW PAIR



Aluminium 2 Pcs Double blister

Art.	€	Length	Height	Thickness
0520/100A	€ 11,90	100 mm	28,3 mm	8,9 mm
0520/125A	€ 13,50	125 mm	28,3 mm	8,9 mm
0520/150A	€ 15,00	150 mm	28,3 mm	8,9 mm

0520-xP

CAT 42

PRISMATIC ALUMINIUM MAGNETIC JAW PAIR



Aluminium 2 Pcs Double blister

Art.	€	Length	Height	Thickness
0520/100P	€ 11,90	100 mm	28,5 mm	9,8 mm
0520/125P	€ 13,50	125 mm	28,5 mm	9,8 mm
0520/150P	€ 15,00	150 mm	28,5 mm	9,8 mm

0520-xF

CAT 42

ALUMINIUM MAGNETIC JAW PAIR WITH FIBER FACE



Aluminium 2 Pcs Double blister

Art.	€	Length	Height	Thickness
0520/100F	€ 11,90	100 mm	28,7 mm	10,3 mm
0520/125F	€ 13,50	125 mm	28,7 mm	10,3 mm
0520/150F	€ 15,00	150 mm	28,7 mm	10,3 mm

0520-xS

CAT 42

SERIES OF ALUMINIUM MAGNETIC JAW PAIRS

INCLUDES THE ITEMS 0520/100A, 0520/100F, 0520/100G, 0520/100P



Aluminium 2 Pairs Double blister

Art.	€	Length
0520/100S	€ 35,60	100 mm
0520/125S	€ 40,40	125 mm
0520/150S	€ 45,10	150 mm

0205

€ 26,40

SPECIAL VICE FOR 90° WELDING



Capacity	70 mm + 70 mm
Working height	35 mm
Weight	0,9 kg

0205/120

€ 91,00

SPECIAL VICE FOR 90° WELDING



Capacity	110 mm + 110 mm
Working height	60 mm
Weight	10 kg

0250

€ 36,90

4-WAY CLAMPING SYSTEM

PROVIDED IN ASSEMBLY KIT, FOR DOORS OR WOODEN TABLES (WOOD STRIPS NOT INCLUDED)



Max thickness	150 mm
Weight	1,9 kg

M006-

GENERAL USE STEEL CLAMP WITH T-SPINDLE

Art.	€	Span x Depth	Rail	Weight
M006/200	€ 22,90	200 x 120 mm	22 x 10,5 mm	1,20 kg
M006/300	€ 32,10	300 x 140 mm	25 x 12 mm	1,80 kg
M006/400	€ 32,50	420 x 120 mm	25 x 12 mm	1,90 kg
M006/500	€ 36,10	500 x 120 mm	25 x 12 mm	2,10 kg
M006/600	€ 51,90	600 x 120 mm	25 x 12 mm	2,30 kg
M006/800	€ 62,30	800 x 120 mm	25 x 12 mm	3,00 kg
M006/1000	€ 74,00	1000 x 120 mm	25 x 12 mm	3,50 kg



M007-

GENERAL USE STEEL CLAMP RATCHET

Art.	€	Span x Depth	Rail	Weight
M007/250	€ 44,90	250 x 120 mm	22 x 10,5 mm	1,46 kg
M007/300	€ 51,90	300 x 140 mm	25 x 12 mm	2,42 kg
M007/400	€ 56,60	400 x 120 mm	25 x 12 mm	2,55 kg
M007/500	€ 61,00	500 x 120 mm	25 x 12 mm	2,76 kg
M007/600	€ 67,90	600 x 120 mm	25 x 12 mm	2,97 kg



M018-

GENERAL USE STEEL CLAMP WITH T-SPINDLE

Art.	€	Span x Depth	Rail	Weight
M018/0200	€ 17,20	200 x 100 mm	19 x 9,5 mm	0,90 kg
M018/0300	€ 20,60	300 x 100 mm	19 x 9,5 mm	1,00 kg
M018/0400	€ 23,50	400 x 120 mm	21,5 x 10,5 mm	1,40 kg
M018/0500	€ 25,80	500 x 120 mm	21,5 x 10,5 mm	1,60 kg
M018/0600	€ 25,80	600 x 120 mm	21,5 x 10,5 mm	1,70 kg
M018/0800	€ 30,00	800 x 120 mm	21,5 x 10,5 mm	2,00 kg
M018/1000	€ 34,30	1000 x 120 mm	21,5 x 10,5 mm	2,20 kg
M018/1200	€ 38,60	1200 x 120 mm	21,5 x 10,5 mm	2,50 kg

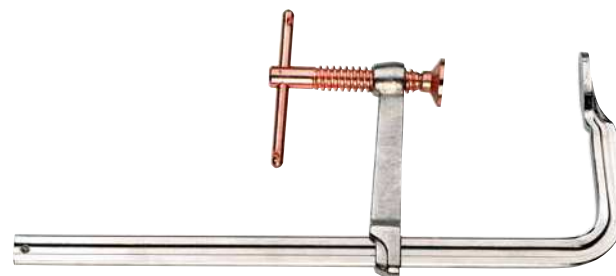

0167-

WOOD HANDLE CLAMP



Art.	€	Span x Depth
0167/150	€ 2,88	150 x 50 mm
0167/200	€ 5,40	200 x 80 mm
0167/250	€ 6,00	250 x 100 mm
0167/400	€ 8,20	400 x 100 mm
0167/500	€ 10,30	500 x 120 mm

0394-

QUICK ADJUSTABLE CLAMP



Art.	€	Span x Depth	Rail	Maximum torque	Weight
0394/150	€ 6,40	150 x 63 mm	18 x 5,5 mm	60 kg	0,50 kg
0394/300	€ 8,60	300 x 63 mm	18 x 5,5 mm	60 kg	0,60 kg
0394/450	€ 9,90	450 x 63 mm	18 x 5,5 mm	60 kg	0,70 kg
0394/600	€ 12,00	600 x 63 mm	18 x 5,5 mm	60 kg	0,80 kg

0353/085

€ 5,90

POLYPROPYLENE SPRING CLAMPS SET

LENGTH 85 mm, USEFUL IN THE LABORATORY TO FACILITATE THE GLUINGS AND SIMILAR WORKS



12 Pcs Hanging package

Lunghezza	85 mm
Apertura	35 mm

0353/110

€ 6,30

POLYPROPYLENE SPRING CLAMPS SET

110 mm LONGS, USEFUL IN THE LABORATORY TO FACILITATE THE GLUINGS AND SIMILAR WORKS



8 Pcs Hanging package

Lunghezza	110 mm
Apertura	40 mm

035x

SPRING CLAMP

PACKED IN HANGING POLYBAG



Hanging package

Art.	€	Length	Opening
0353/150	€ 2,77	150 mm	55 mm
0354/225	€ 3,80	225 mm	100 mm

0265/05

€ 29,50

CAST IRON ANVIL



A	230 mm
B	160 mm
E	57 mm
F	10,5 mm
W	112 mm
WI	85 mm
HI	95 mm
Tolerance	±5%
Weight	5 kg

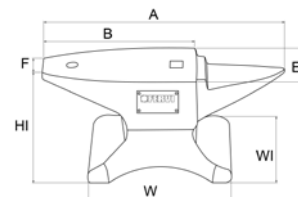

0157-

C50 HARDENED STEEL ANVIL

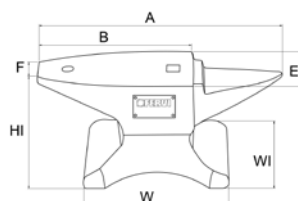

Art.	€	A	B	E	F	W	WI	HI	Tolerance	Weight
0157/10	€ 94,40	270 mm	185 mm	80 mm	30 mm	195 mm	85 mm	150 mm	±5%	10 kg
0157/30	€ 227,00	415 mm	265 mm	110 mm	50 mm	245 mm	160 mm	185 mm	±5%	30 kg
0157/50	€ 330,00	500 mm	310 mm	140 mm	60 mm	300 mm	190 mm	220 mm	±5%	50 kg
0157/100	€ 690,00	635 mm	420 mm	200 mm	85 mm	350 mm	250 mm	260 mm	±5%	100 kg



0149

€ 25,30

HEAVY DUTY STAPLE GUN TACKER

WITH 500 STAPLES AND 500 NAILS



Blister

C586

€ 111,00

AIR BRAD NAILER



Blow mold case

Loader capacity	120
Working pressure	5 - 7 bar
Overall sizes	260 x 240 x 65 mm
Nails	F - 10 / 50 mm
Weight	1,30 kg

F588/6

€ 107,00

AIR BRADDER FOR MINI PINS



Blow mold case

Loader capacity	195
Working pressure	5 - 7 bar
Overall sizes	235 x 198 x 46 mm
Staples	0,60 - 12 / 25 mm
Weight	1,00 kg

F585

€ 115,00

2 IN 1 AIR STAPLER AND BRAD NAILER



Blow mold case

Loader capacity	100
Working pressure	5 - 7 bar
Overall sizes	255 x 230 x 67 mm
Nails	F - 10 / 50 mm
Staples	90 - 10 / 40 mm
Weight	1,40 kg

0587

€ 78,40

AIR STAPLER



Blow mold case

Loader capacity	100
Working pressure	5 - 7 bar
Overall sizes	225 x 165 x 45 mm
Staples	80 - 6 / 16 mm
Weight	0,86 kg

0585

€ 95,00

2 IN 1 AIR STAPLER AND BRAD NAILER



Blow mold case

Loader capacity	80
Working pressure	5 - 7 bar
Overall sizes	245 x 230 x 55 mm
Nails	F - 10 / 50 mm
Staples	90 - 10 / 40 mm
Weight	1,38 kg



0586

€ 87,10

AIR BRAD NAILER



Blow mold case

Loader capacity	110
Working pressure	5 - 7 bar
Overall sizes	245 x 225 x 55 mm
Nails	F - 10 / 50 mm
Weight	1,48 kg

0588/6

€ 74,00

AIR BRADDER FOR MINI PINS



Blow mold case

Loader capacity	130
Working pressure	5 - 7 bar
Overall sizes	225 x 170 x 45 mm
Staples	0,60 - 12 / 25 mm
Weight	1,05 kg

C589

€ 63,30

AIR PALM NAILER

Box

Working pressure	5 - 7 bar
Overall sizes	111 x 115 x 70 mm
Nails	ø 2.5 ÷ 4.1 - head ø 6.3 ÷ 8.7 - length 38 ÷ 90 mm
Weight	0,46 kg



COMPATIBILITY CHART



ART.	€	0587/8006	0587/8008	0587/8010	0587/8012	0587/8014	0587/8016	0585/9013	0585/9019	0585/9032	0585/9040	PAG
0149	25,30											453
0585	95,00							•	•	•	•	453
F585	115,00							•	•	•	•	453
0586	87,10											454
C586	111,00											453
0587	78,40	•	•	•	•	•	•					453
0588/6	74,00											454
F588/6	107,00											453
C589	63,30											454

ART.	€	0584/F10	0584/F15	0584/F20	0584/F25	0584/F30	0584/F35	0584/F40	0584/F45	0584/F50	0588/615	0588/620	0588/625	0150	0151	PAG
0149	25,30															453
0585	95,00	•	•	•	•	•	•	•	•	•						453
F585	115,00	•	•	•	•	•	•	•	•	•						453
0586	87,10															454
C586	111,00	•	•	•	•	•	•	•	•	•						453
0587	78,40															453
0588/6	74,00										•	•	•			454
F588/6	107,00										•	•	•			453
C589	63,30															454

ART.	€	0049	0240/15	5075/08X5	5075/10X6.5	5075/08X5	5100/08X5	5100/10X6.5	5100/12X8	0783/1M	0777/2	0777/3	PAG
0585	95,00	•	•	•	•	•	•	•	•	•	•	•	453
F585	115,00	•	•	•	•	•	•	•	•	•	•	•	453
0586	87,10												454
C586	111,00	•	•	•	•	•	•	•	•	•	•	•	453
0587	78,40	•	•	•	•	•	•	•	•	•	•	•	453
0588/6	74,00	•	•	•	•	•	•	•	•	•	•	•	454
F588/6	107,00	•	•	•	•	•	•	•	•	•	•	•	453
C589	63,30	•	•	•	•	•	•	•	•	•	•	•	454
C589	80,00	•	•	•	•	•	•	•	•	•	•	•	586

AP01

CAT 42 € 197,00

AIR IMPACT WRENCH

PROFESSIONAL SERIES. IN COMPOSITE MATERIAL, HANDLE AND HEAD IN SHOCKPROOF RUBBER. OPERATING LEVER, CHANGE OF ROTATION AND SPEED ADJUSTMENT OPERATED WITH ONE HAND. HIGH POWER AND GREAT RELIABILITY



3/8" Box

Speeds	8500 rpm
Torque	542 Nm 400 lb-ft
Avg air cons.	108 l/min 3.8 SCFM
Working pressure	6 bar 90 psi
Weight	1.16 kg 255.7 lb kg

AP02

CAT 42 € 204,00

AIR IMPACT WRENCH

PROFESSIONAL SERIES. IN COMPOSITE MATERIAL, HANDLE AND HEAD IN SHOCKPROOF RUBBER. OPERATING LEVER, CHANGE OF ROTATION AND SPEED ADJUSTMENT OPERATED WITH ONE HAND. HIGH POWER AND GREAT RELIABILITY



1/2" Box

Speeds	7800 rpm
Torque	678 Nm 500 lb-ft
Avg air cons.	136 l/min 4.8 SCFM
Working pressure	6 bar 90 psi
Weight	1.16 kg 255.7 lb kg

AP03

CAT 42 € 211,00

AIR IMPACT WRENCH

PROFESSIONAL SERIES. IN COMPOSITE MATERIAL, HANDLE AND HEAD IN SHOCKPROOF RUBBER. OPERATING LEVER, CHANGE OF ROTATION AND SPEED ADJUSTMENT OPERATED WITH ONE HAND. HIGH POWER AND GREAT RELIABILITY



1/2" Box

Speeds	7300 rpm
Torque	1085 Nm 800 lb-ft
Avg air cons.	153 l/min 5.4 SCFM
Working pressure	6 bar 90 psi
Weight	2.0 kg 4.4 lb kg

AP04

CAT 42 € 219,00

AIR IMPACT WRENCH

PROFESSIONAL SERIES. IN COMPOSITE MATERIAL, HANDLE AND HEAD IN SHOCKPROOF RUBBER. OPERATING LEVER, CHANGE OF ROTATION AND SPEED ADJUSTMENT OPERATED WITH ONE HAND. HIGH POWER AND GREAT RELIABILITY



3/4" Box

Speeds	7300 rpm
Torque	1085 Nm 800 lb-ft
Avg air cons.	153 l/min 5.4 SCFM
Working pressure	6 bar 90 psi
Weight	2.1 kg 4.60 lb kg



AP05

CAT 42 € 510,00

AIR IMPACT WRENCH

PROFESSIONAL SERIES. IN COMPOSITE MATERIAL, HANDLE AND HEAD IN SHOCKPROOF RUBBER. OPERATING LEVER, CHANGE OF ROTATION AND SPEED ADJUSTMENT OPERATED WITH ONE HAND. HIGH POWER AND GREAT RELIABILITY



3/4" Box

Speeds	5300 rpm
Torque	1900 Nm 1400 lb-ft
Avg air cons.	224 l/min 8.1 SCFM
Working pressure	6 bar 90 psi
Weight	3.3 kg 7.7 lb kg

AP05/150

CAT 42 € 613,00

AIR IMPACT WRENCH

PROFESSIONAL SERIES. IN COMPOSITE MATERIAL, HANDLE AND HEAD IN SHOCKPROOF RUBBER. OPERATING LEVER, CHANGE OF ROTATION AND SPEED ADJUSTMENT OPERATED WITH ONE HAND. HIGH POWER AND GREAT RELIABILITY, WITH 150MM ANVIL



3/4" Box

Speeds	5300 rpm
Torque	1900 Nm 1400 lb-ft
Avg air cons.	224 l/min 8.1 SCFM
Working pressure	6 bar 90 psi
Weight	3.3 kg 7.7 lb kg

AP06

CAT 42 € 197,00

AIR IMPACT WRENCH

PROFESSIONAL SERIES. IN COMPOSITE MATERIAL, HANDLE AND HEAD IN SHOCKPROOF RUBBER. OPERATING LEVER, CHANGE OF ROTATION AND SPEED ADJUSTMENT OPERATED WITH ONE HAND. HIGH POWER AND GREAT RELIABILITY



1/2" Box

Speeds	9000 rpm
Torque	312 Nm 230 lb-ft
Avg air cons.	113 l/min 4 SCFM
Working pressure	6 bar 90 psi
Weight	1.09 kg 2.4 lb kg

0573

€ 98,20

AIR IMPACT WRENCH



3/8" Box

Speeds	10000 rpm
Torque	244 Nm
Avg air cons.	4 SCFM (120 l/min)
Working pressure	6 bar / 90 psi
Weight	1,5 kg

0571

€ 134,00

AIR IMPACT WRENCH



Speeds	7000 rpm
Torque	610 Nm
Avg air cons.	5 SCFM (150 l/min)
Working pressure	6 bar / 90 psi
Weight	2,6 kg

0576

€ 141,00

AIR IMPACT WRENCH



Speeds	7000 rpm
Torque	435 Nm
Avg air cons.	5 SCFM (150 l/min)
Working pressure	6 bar / 90 psi
Weight	2,48 kg

0786

€ 237,00

AIR IMPACT WRENCH



Speeds	4200 rpm
Torque	950 Nm
Avg air cons.	8 SCFM (240 l/min)
Working pressure	6 bar / 90 psi
Weight	4,8 kg

0044

€ 78,40

AIR IMPACT WRENCH SET



Speeds	7000 rpm
Torque	320 Nm
Socket	9-10-11-13-14-17-19-22-24-27 mm
Extension	125 mm
Avg air cons.	5 SCFM (150 l/min)
Working pressure	6 bar / 90 psi
Weight	4,2 kg

0045

€ 47,00

AIR IMPACT WRENCH



Speeds	7000 rpm
Torque	320 Nm
Avg air cons.	5 SCFM (150 l/min)
Working pressure	6 bar / 90 psi
Weight	2,3 kg

0052

€ 111,00

AIR IMPACT WRENCH



Speeds	4800 rpm
Torque	680 Nm
Avg air cons.	6 SCFM (180 l/min)
Working pressure	6 bar / 90 psi
Weight	4,7 kg



0046

€ 74,00

AIR RATCHET WRENCH SET

16 Pcs 1/2" Box

Speeds	160 rpm
Torque	65 Nm
Socket	9-10-11-13-14-17-19 mm
Extension	75 mm
Universal joint	1/2"
Bit holder	1/4"
Avg air cons.	4 SCFM (120 l/min.)
Working pressure	6 bar / 90 psi
Weight	2,86 kg



0047

€ 59,80

1 1/4" REVERSIBLE AIR SCREWDRIVER



Box

Speeds	9000 rpm
Capacity	4-5 mm
Torque	2,3 - 6,8 Nm
Length	180 mm
Avg air cons.	5 SCFM (150 l/min.)
Working pressure	6 bar / 90 psi

0339

€ 61,00

REVERSIBLE AIR DRILL



Box

Chuck sizes	Ø 10 mm
Speeds	1800 rpm
Avg air cons.	5 SCFM (150 l/min.)
Working pressure	6 bar / 90 psi
Weight	1,1 kg

0574

€ 81,20

REVERSIBLE AIR DRILL

Box

Chuck sizes	Ø 10 mm
Speeds	1800 rpm
Avg air cons.	5 SCFM (150 l/min.)
Working pressure	6 bar / 90 psi
Weight	1 kg



COMPATIBILITY CHART

ART.	€	0049	0240/15	S075/08X5	S075/10X6.5	S075/08X5	PAG
0573	98,20	•	•	•	•	•	456
0571	134,00	•	•	•	•	•	457
0576	141,00	•	•	•	•	•	457
0786	237,00	•	•	•	•	•	457
0044	78,40	•	•	•	•	•	457
0045	47,00	•	•	•	•	•	457
0052	111,00	•	•	•	•	•	457
0046	74,00	•	•	•	•	•	458
0047	59,80	•	•	•	•	•	458

ART.	€	0049	0240/15	S075/08X5	S075/10X6.5	S075/08X5	PAG
0339	61,00	•	•	•	•	•	458
0574	81,20	•	•	•	•	•	458
AP01	197,00	•	•	•	•	•	455
AP02	204,00	•	•	•	•	•	455
AP03	211,00	•	•	•	•	•	455
AP04	219,00	•	•	•	•	•	455
AP05	510,00	•	•	•	•	•	456
AP05/150	613,00	•	•	•	•	•	456
AP06	197,00	•	•	•	•	•	456

0313

€ 83,10

5" AIR ANGLE DIE GRINDER



Box

Saw blade	Ø 125 mm
Speeds	10000 rpm
Avg air cons.	5 SCFM (150 l/min.)
Working pressure	6 bar / 90 psi
Weight	2,2 kg

0051

€ 24,40

AIR DIE GRINDER



Box

Collets	Ø 3 mm - Ø 6 mm
Speeds	22000 rpm
Avg air cons.	4 SCFM (120 l/min.)
Working pressure	6 bar / 90 psi
Weight	0,8 kg

0115

€ 45,70

AIR DIE GRINDER



Box

Collets	Ø 3 mm - Ø 6 mm
Speeds	20000 rpm
Length	295 mm
Avg air cons.	4 SCFM (120 l/min.)
Working pressure	6 bar / 90 psi
Weight	0,7 kg

0050

€ 35,80

AIR DIE GRINDER SET



Blow mold case

Collets	Ø 3 mm - Ø 6 mm
Mounted stone	10 Pcs / Pcs
Speeds	22000 rpm
Avg air cons.	4 SCFM (120 l/min.)
Working pressure	6 bar / 90 psi
Weight	1,4 kg

0570

€ 82,10

AIR DIE GRINDER SET



Blow mold case

Collets	Ø 3 mm - Ø 6 mm
Mounted stone	10 Pcs
Speeds	21000 rpm
Power	0,45 hp
Avg air cons.	5 SCFM (150 l/min.)
Working pressure	6 bar / 90 psi
Rear exhaust	
Weight	1,3 kg

0641

€ 52,30

FLEXIBLE PNEUMATIC MICROGRINDING WHEEL



Blow mold case

Collet capacity	3 mm
Speeds	56000 rpm
Avg air cons.	2 SCFM (60 l/min.)
Working pressure	6 bar / 90 psi
Weight	0,82 kg



0784

€ 61,40

AIR BELT SANDER



Box

Speeds	16000 rpm
Avg air cons.	6 SCFM (180 l / min.)
Working pressure	6 bar / 90 psi
Belt	10 x 330 mm

0059

€ 28,60

HEAVY DUTY AIR HAMMER WITH 4 HEXAGONAL CHISELS



Box

Speeds	BPM 3500
Bore-stroke	19 x 66 mm / 3/4" x 2 5/8"
Avg air cons.	4,5 SCFM (135 l/min)
Working pressure	6 bar / 90 psi
Weight	1,5 kg

0414

€ 29,10

AIR DIE GRINDER

3 AND 6 mm, WITH REAR EXHAUST 360°, EXCLUSIVE COMPOSITE BODY DESIGN



Box

Collets	ø 3 mm - ø 6 mm
Speeds	22000 rpm
Avg air cons.	7 SCFM (198 l/min)
Working pressure	6 bar / 90 psi
Air inlet	1/4"
Weight	580 g

0644

€ 33,80

PNEUMATIC AXIAL GRINDING WHEEL



Blow mold case

Saw blade	ø 75 x 1,5 x ø 10 mm
Speeds	15000 rpm
Avg air cons.	5 SCFM (150 l/min.)
Working pressure	6 bar / 90 psi
Weight	0,72 kg

0413

€ 25,50

MINI AIR DIE GRINDER

3 AND 6 mm, WITH REAR EXHAUST 360°, EXCLUSIVE COMPOSITE BODY DESIGN



Box

Collets	ø 3 mm - ø 6 mm
Speeds	25000 rpm
Avg air cons.	4 SCFM (113 l/min)
Working pressure	6 bar / 90 psi
Air inlet	1/4"
Weight	350 g

0416

€ 45,30

90° AIR DIE GRINDER

3 AND 6 mm, WITH REAR EXHAUST 360°, EXCLUSIVE COMPOSITE BODY DESIGN



Box

Collets	ø 3 mm - ø 6 mm
Speeds	20000 rpm
Avg air cons.	4 SCFM (113 l/min)
Working pressure	6 bar / 90 psi
Weight	550 g
Air inlet	1/4"

0417

€ 50,00

LONG TYPE AIR DIE GRINDER

3 AND 6 mm, WITH REAR EXHAUST 360°, EXCLUSIVE COMPOSITE BODY DESIGN



Box

Collets	ø 3 mm - ø 6 mm
Length	295 mm
Speeds	20000 rpm
Avg air cons.	4 SCFM (113 l/min)
Working pressure	6 bar / 90 psi
Weight	600 g
Air inlet	1/4"

0419

€ 74,90

6" AIR ORBIT SANDER WITH SUCTION

AND SPEED CONTROL, HOOK & LOOP PAD, 360° REAR EXHAUST, DIE CAST ALUMINUM BODY WITH SOFT HANDLE GRIP IN LIGHTWEIGHT AND ERGONOMIC DESIGN



Box

Disc diameter	150 mm - 6"
Orbit	5 mm, 3/16"
Speeds	10500 rpm MAX.
Avg air cons.	3 SCFM (85 l/min)
Working pressure	6 bar / 90 psi
Air inlet	1/4"
Length	200 mm
Weight	950 g

0458

€ 74,90

6" AIR ORBIT SANDER WITH SUCTION

SPEED CONTROL, 2.5 mm ORBIT, HOOK & LOOP PAD, 360° REAR EXHAUST, DIE CAST ALUMINUM BODY WITH SOFT HANDLE GRIP IN LIGHTWEIGHT AND ERGONOMIC DESIGN



Box

Disc diameter	150 mm - 6"
Orbit	2,5 mm - 3 / 32"
Max speed	10500 rpm
Avg air cons.	3 SCFM (85 l/min)
Working pressure	6 bar / 90 psi
Air inlet	1/4"
Length	200 mm
Weight	950 g

0418

€ 44,40

REVERSIBLE AIR DRILL

3/8", WITH REAR EXHAUST 360°, EXCLUSIVE COMPOSITE BODY DESIGN



Box

Chuck sizes	10 0 mm
Speeds	1800 rpm
Avg air cons.	4 SCFM (113 l/min)
Working pressure	6 bar / 90 psi
Weight	850 g
Air inlet	1/4"

0421

€ 81,50

6" AIR ORBIT SANDER WITH SELF-INTEGRATED SUCTION

SPEED CONTROL, HOOK & LOOP PAD, 360° REAR EXHAUST, DIE CAST ALUMINUM BODY WITH SOFT HANDLE GRIP IN LIGHTWEIGHT AND ERGONOMIC DESIGN, CORRUGATED HOSE AND DUST BAG



Box

Disc diameter	150 mm - 6"
Orbit	5 mm, 3/16"
Speeds	10500 rpm
Avg air cons.	3 SCFM (85 l/min)
Working pressure	6 bar / 90 psi
Air inlet	1/4"
Length	200 mm
Weight	980 g

0460

€ 88,40

6" AIR ORBIT SANDER WITH SELF-INTEGRATED SUCTION

SPEED CONTROL, 2.5MM ORBIT, HOOK AND LOOP PAD, 360° REAR EXHAUST, DIE CAST ALUMINUM BODY WITH SOFT HANDLE GRIP IN LIGHTWEIGHT AND ERGONOMIC DESIGN, CORRUGATED HOSE AND DUST BAG



Box

Disc diameter	150 mm - 6"
Orbit	2,5 mm - 3 / 32"
Max speed	10500 rpm
Avg air cons.	3 SCFM (85 l/min)
Working pressure	6 bar / 90 psi
Air inlet	1/4"
Length	200 mm
Weight	980 g



0459

€ 6,30

HOOK AND LOOP PAD

WITH 6 HOLES AND 5/16" -24TPI MALE THREAD



Disc diameter	150 mm - 6"
Max speed	12000 rpm
Weight	130 g

COMPATIBILITY CHART

ART.	€	0459	0049	0240/15	S075/08X5	S075/10X6.5	S075/08X5	S100/08X5	S100/10X6.5	S100/12X8	0783/1M	0777/2	0777/3	PAG
0313	83,10	*	*	*	*	*	*	*	*	*	*	*	*	459
0050	35,80	*	*	*	*	*	*	*	*	*	*	*	*	459
0051	24,40	*	*	*	*	*	*	*	*	*	*	*	*	459
0570	82,10	*	*	*	*	*	*	*	*	*	*	*	*	459
0115	45,70	*	*	*	*	*	*	*	*	*	*	*	*	459
0641	52,30	*	*	*	*	*	*	*	*	*	*	*	*	459
0784	61,40	*	*	*	*	*	*	*	*	*	*	*	*	460
0644	33,80	*	*	*	*	*	*	*	*	*	*	*	*	460
0059	28,60	*	*	*	*	*	*	*	*	*	*	*	*	460

0049

€ 7,30

1/4" OILER

FOR PNEUMATIC TOOLS



Blister

ART.	€	0459	0049	0240/15	S075/08X5	S075/10X6.5	S075/08X5	S100/08X5	S100/10X6.5	S100/12X8	0783/1M	0777/2	0777/3	PAG
0413	25,50	*	*	*	*	*	*	*	*	*	*	*	*	460
0414	29,10	*	*	*	*	*	*	*	*	*	*	*	*	460
0416	45,30	*	*	*	*	*	*	*	*	*	*	*	*	460
0417	50,00	*	*	*	*	*	*	*	*	*	*	*	*	461
0418	44,40	*	*	*	*	*	*	*	*	*	*	*	*	461
0419	74,90	*	*	*	*	*	*	*	*	*	*	*	*	461
0421	81,50	*	*	*	*	*	*	*	*	*	*	*	*	461
0458	74,90	*	*	*	*	*	*	*	*	*	*	*	*	461
0460	88,40	*	*	*	*	*	*	*	*	*	*	*	*	461

0543

€ 17,20

CAR EMERGENCY DIGITAL TIRE GAUGE

SUITABLE IN EMERGENCY CONDITIONS, IT CAN BE USED IN 4 DIFFERENT WAYS: DIGITAL TIRE GAUGE, LED FLASHLIGHT, GLASS BREAKER HAMMER, SEAT BELT CUTTER



Blister

Range	3÷150 psi, 0.21÷10.34 bar, 21÷1034 kPa
Working temperature	-20°C ~ + 50° C
Included batteries	2 AA
Weight	0,152 kg

0836

€ 14,30

DIGITAL PRESSURE GAUGE

WITH TYRE DEPTH GAUGE AND LED LIGHT



Blister

Range	0,5 ÷ 99.5 psi, 0.034 ÷ 6.86 bar, 3,45 ÷ 686 kPa
Accuracy	±1%
Included batteries	3 x SR44

W021PA

€ 5,90

BLOW GUN



Blister

Nozzle	2.0 mm
Working pressure	2 - 6 bar

W021PN

€ 12,30

WASHING GUN

WITH ALUMINIUM BODY AND STEEL CUP



Box

Capacity	900 ml
Nozzle	4.5 mm
Working pressure	3 - 4 bar
Weight	520 g

0125

€ 30,90

DIGITAL TYRE GAUGE

WITH BACKLIGHT AND VARIOUS MEASUREMENT UNITS



Blister

Max. pressure	8 bar (110 psi)
Working pressure	2 - 4 bar (30 - 60 psi)
Reading	0.05 bar (0.7 psi)
Not included batteries	2 x 1.5V AAA
Rubber hose length	80 mm

W021PG

€ 15,00

TYRE INFLATING GUN



Blister

Max. pressure	12 bar (170 psi)
Working pressure	2 - 4 bar (30 - 60 psi)
Accuracy	±1%
Rubber hose length	440 mm

0607

€ 5,40

BLOW GUN



Blister

0608

€ 15,10

TYRE INFLATING GUN



Blister

Manometer	ø 63 mm
Reading	0 ÷ 12 bar (0 ÷ 174 psi)
Rubber hose length	420 mm



0610

€ 12,40

WASHING GUN



Box

Capacity 1000 cc

0725

€ 5,50

BLOW GUN



Blister

Hose length 100 mm

0412

€ 8,90

BLOW GUN

HIGH QUALITY, WITH CHROMED STEEL 100 mm NOZZLE GUN BODY IN POM PLASTIC (POLYOXYMETHYLENE) BRASS VALVE



Blister

Hose length 100 mm
Air inlet 1/4"

0609

€ 37,00

TYRE INFLATING GUN

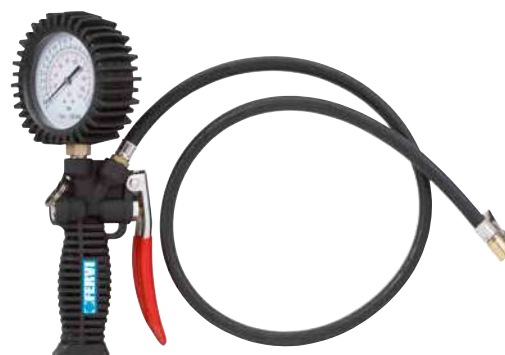

Blister

Manometer	ø 80 mm
Reading	0 ÷ 12 bar (0 ÷ 174 psi)
Rubber hose length	1.000 mm

0725L

€ 7,50

LONG NOSE BLOW GUN



Blister

Hose length 275 mm



TH601A

€ 125,00

GRAVITY FEED SPRAY GUN

600 ML FEED HVLP SPRAY GUN, NYLON GRAVITY CUP, MADE WITH CNC MACHINE, WITHOUT O-RING, WITH STAINLESS STEEL NOZZLE AND NEEDLE, BRASS AIR CAP, ALUM CLAMP AND KNOBS, MALE THREAD FITTING 1/4" HVLP = HIGH VOLUME, LOW PRESSURE

Box

Capacity	600 ml
Nozzle diameter	1,3 mm
Fluid delivery	130 ml/min
Working pressure	2 bar (29 PSI)
Working distance	200 mm
Pattern	280 - 300 mm
Weight	500 g



TH602A

€ 102,00

GRAVITY FEED SPRAY GUN

100 ML FEED HVLP SPRAY GUN, NYLON GRAVITY CUP, MADE WITH CNC MACHINE, WITHOUT O-RING, WITH STAINLESS STEEL NOZZLE AND NEEDLE, BRASS AIR CAP, ALUM CLAMP AND KNOBS, MALE THREAD FITTING 1/4" HVLP = HIGH VOLUME, LOW PRESSURE

Box

Capacity	100 ml
Nozzle diameter	1,0 mm
Fluid delivery	50 ml/min
Working pressure	1,5 bar (20 PSI)
Working distance	150 mm
Pattern	160 mm
Weight	300 g



TH901A

€ 125,00

GRAVITY FEED SPRAY GUN

600 ML FEED LVMP SPRAY GUN, NYLON GRAVITY CUP, MADE WITH CNC MACHINE, WITHOUT O-RING, WITH STAINLESS STEEL NOZZLE AND NEEDLE, BRASS AIR CAP, ALUM CLAMP AND KNOBS, MALE THREAD FITTING 1/4" LVMP = LOW VOLUME, MEDIUM PRESSURE

Box

Capacity	600 ml
Nozzle diameter	1,3 mm
Fluid delivery	140 ml/min
Working pressure	2 ÷ 2,2 bar (29 ÷ 32 PSI)
Working distance	200 mm
Pattern	270 - 300 mm
Weight	500 g



A601DS

€ 83,10

SUCTION SPRAY GUN

1000 ML SUCTION HVLP SPRAY GUN WITH BAIONET LOCK, ALUMINUM CUP, MADE WITH CNC MACHINE, WITHOUT O-RING, WITH STAINLESS STEEL NOZZLE AND NEEDLE BRASS AIR CAP, ALUM CLAMP AND KNOBS, CHROME PLATED SPRAY GUN BODY, MALE THREAD FITTING 1/4" HVLP = HIGH VOLUME, LOW PRESSURE

Box

Nozzle	ø 1,4mm
Capacity	1000 cc
Working pressure	2,5 - 3 bar



A601A

€ 80,30

GRAVITY FEED SPRAY GUN

600 ML FEED HVLP SPRAY GUN, NYLON GRAVITY CUP, MADE WITH CNC MACHINE, WITHOUT O-RING, WITH STAINLESS STEEL NOZZLE AND NEEDLE BRASS AIR CAP, BLUE COLOR ALUM CLAMP AND KNOBS, CHROME PLATED SPRAY GUN BODY, MALE THREAD FITTING 1/4" HVLP = HIGH VOLUME, LOW PRESSURE

Box

Nozzle	ø 1,4mm
Capacity	600 cc
Working pressure	2,5 - 3,5 bar



A602A

€ 51,90

GRAVITY FEED SPRAY GUN

10 ML FEED HVLP SPRAY GUN, NYLON GRAVITY CUP, MADE WITH CNC MACHINE, WITHOUT O-RING, WITH STAINLESS STEEL NOZZLE AND NEEDLE BRASS AIR CAP, BLUE COLOR ALUM CLAMP AND KNOBS, CHROME PLATED SPRAY GUN BODY, MALE THREAD FITTING 1/4" HVLP = HIGH VOLUME, LOW PRESSURE

Box

Nozzle	ø 1,0mm
Capacity	100 cc
Working pressure	2 - 2,5 bar



A901A

€ 78,90

GRAVITY FEED SPRAY GUN

600 ML FEED LVMP SPRAY GUN, NYLON GRAVITY CUP, MADE WITH CNC MACHINE, WITHOUT O-RING, WITH STAINLESS STEEL NOZZLE AND NEEDLE, BRASS AIR CAP, BLUE COLOR ALUM CLAMP AND KNOBS, CHROME PLATED SPRAY GUN BODY, MALE THREAD FITTING 1/4" LVMP = LOW VOLUME, MEDIUM PRESSURE

 Box

Capacity	600 ml
Nozzle diameter	1,4 mm
Fluid delivery	200-380 ml/min
Max. pressure	2-3 bar (30-43 PSI)
Weight	606 g



A902A

€ 52,90

GRAVITY FEED SPRAY GUN

100 ML FEED LVMP SPRAY GUN, NYLON GRAVITY CUP, MADE WITH CNC MACHINE, WITHOUT O-RING, WITH STAINLESS STEEL NOZZLE AND NEEDLE BRASS AIR CAP, BLUE COLOR ALUM CLAMP AND KNOBS, CHROME PLATED SPRAY GUN BODY, MALE THREAD FITTING 1/4" LVMP = LOW VOLUME, MEDIUM PRESSURE

 Box

Capacity	100 ml
Nozzle diameter	1 mm
Fluid delivery	45 - 65 ml/min
Max. pressure	1.5 - 2.5 bar (22 - 36 PSI)
Weight	306 g



A162DS

€ 31,70

SPRAY GUN WITH FLUID CUP PROVIDED WITH BAYONET LOCK

 Box

Nozzle	ø 1,8 mm
Capacity	1000 cc
Working pressure	4-8 bar
Air consumption	100-200 l/min



A162C

€ 22,50

SPRAY GUN WITH FLUID CUP PROVIDED WITH RAPID LOCK

 Box

Nozzle	ø 1,8 mm
Capacity	1000 cc
Working pressure	4-8 bar
Air consumption	100-200 l/min



A162A

€ 19,00

SPRAY GUN WITH GRAVITY FLOW CUP

 Box

Nozzle	ø 1,8 mm
Capacity	500 cc
Working pressure	4-8 bar
Air consumption	100-200 l/min



0048

€ 14,40

MINI SPRAY GUN

FITTING FOR PRESSURIZED AIR CONTAINER AND 1/4" FITTING FOR AIR COMPRESSOR

 Plastic box



SPRAY GUNS SPARE PARTS

ART.	TH601A	TH602A	TH901A	A601DS	A601A	A602A	A901A	A902A	A162DS	A162C	A162A
TH601A13	•										
TH601A14	•										
TH601A17	•										
TH601A20	•										
TH602A08		•									
TH602A10		•									
TH901A13			•								
TH901A14			•								
TH901A17			•								
TH901A20			•								
A601DS14				•							
A601DS17				•							
A601DS20				•							
A601A14					•						
A601A17					•						
A601A20					•						
A602A08						•					

ART.	TH601A	TH602A	TH901A	A601DS	A601A	A602A	A901A	A902A	A162DS	A162C	A162A
A602A10					•						
A901A14							•				
A901A17							•				
A901A20							•				
A902A08								•			
A902A10								•			
A162DS/1.2C									•		
A162DS/1.5C									•		
A162DS/1.8C									•		
A162DS/2.0C									•		
A162DS/2.5C									•		
U1500R/1.2C										•	•
U1500R/1.5C										•	•
U1500R/1.8C										•	•
U1500R/2.0C										•	•
U1500R/2.5C										•	•

TH250

€ 12,70

PRESSURE REGULATOR

WITH GAUGE FOR AIR TOOLS



Blister

Manometer	ø 40 mm
Reading	0 ÷ 11 bar (0 ÷ 160 psi)

TH500

€ 22,20

PRESSURE REGULATOR

WITH GAUGE FOR AIR TOOLS



Blister

Manometer	ø 30 mm
Reading	0 ÷ 10 bar (0 ÷ 145 psi)

S075-

POLYURETHANE SPIRAL HOSE WITH SWIVEL MALE FITTING

Art.	€	Length	Diameter	Thread
S075/08X5	€ 10,70	7,5 m	ø 8 x 5 mm	1/4"
S075/10X6.5	€ 15,00	7,5 m	ø 10 x 6,5 mm	1/4"
S100/08X5	€ 12,90	10 m	ø 8 x 5 mm	1/4"
S100/10X6.5	€ 19,00	10 m	ø 10 x 6,5 mm	1/4"
S100/12X8	€ 21,00	10 m	ø 12 x 8 mm	3/8"

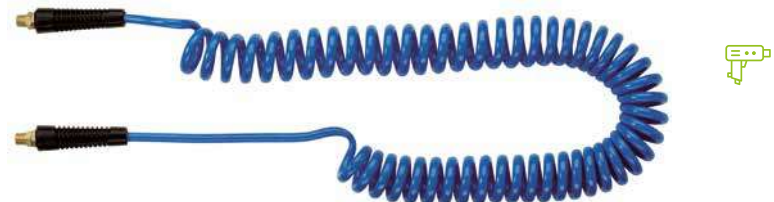

0785-xM

SET 2 PCS UNIVERSAL MALE QUICK COUPLER



Art.	€	Shank
0785/1M	€ 8,30	1/4"
0785/2M	€ 8,30	3/8"

0785-xF

SET 2 PCS UNIVERSAL FEMALE QUICK COUPLER



Art.	€	Shank
0785/1F	€ 8,30	1/4"
0785/2F	€ 8,30	3/8"

0783-xM

SET 2 PCS OF GERMAN TYPE MALE PLUG



Art.	€	Shank
0783/1M	€ 2,35	1/4"
0783/2M	€ 2,35	3/8"

0783-xF

2 PCS SET GERMAN TYPE FEMALE PLUG



Art.	€	Shank
0783/1F	€ 2,17	1/4"
0783/2F	€ 2,17	3/8"

COMPATIBILITY CHART

ART.	€	TH601A	TH602A	TH901A	A601DS	A601A	A602A	A901A	A902A	A162DS	A162C	A162A	PAG
TH250	12,7	•	•	•	•	•	•	•	•	•	•	•	467
TH500	22,2	•	•	•	•	•	•	•	•	•	•	•	467
S075/08X5	10,7	•	•	•	•	•	•	•	•	•	•	•	467
S075/10X6.5	15	•	•	•	•	•	•	•	•	•	•	•	467

ART.	€	TH601A	TH602A	TH901A	A601DS	A601A	A602A	A901A	A902A	A162DS	A162C	A162A	PAG
S100/08X5	12,9	•	•	•	•	•	•	•	•	•	•	•	467
S100/10X6.5	19	•	•	•	•	•	•	•	•	•	•	•	467
S100/12X8	21	•	•	•	•	•	•	•	•	•	•	•	467
0783/1F	2,17	•	•	•	•	•	•	•	•	•	•	•	468

0378/1510

CAT 42 € 137,00

AUTO REWIND AIR HOSE REEL

MADE OF PP SHELL, WITH PU MESH HOSE AND REGULATION FOR DISTRIBUTING EVENLY THE TUBE IN THE INTERNAL PART



Box

Air flow	18 bar / 260 psi
Hose length	15 + 1 m
Male Fitting	3/8" BSPT
Hose diameter	ø 13,5 x 9,5 mm
Working temperature	0 ÷ 45° C
Gross weight	9

0481/15

€ 105,00

AUTO REWIND AIR HOSE REEL

MADE OF ABS, WITH PU MESH HOSE, GERMAN TYPE FEMALE QUICK COUPLER, GERMAN TYPE FEMALE PLUG AND REGULATION FOR DISTRIBUTING EVENLY THE TUBE IN THE INTERNAL PART



Box

Air flow	16 bar / 250 psi
Hose length	15 + 1 m
Male Fitting	1/4" BSPT
Hose diameter	ø 12 x 8 mm
Working temperature	0 ÷ 45° C
Weight	5 kg

0240/15**€ 124,00****AUTO REWIND AIR HOSE REEL**

WITH PU MESH HOSE



Portata	16 bar / 250 psi
Lunghezza tubo	15 m + 1m
Raccordi maschio	1/4" BSPT
Diametro tubo	12 x 8 mm

0777/2**€ 31,90****REDUCER WITH GAUGE AND FILTER**

Attacco	1/4" - 3/8" - 1/2"
---------	--------------------

0777/3**€ 56,60****REDUCER WITH GAUGE, FILTER AND OILER**

Shank	1/4" - 3/8" - 1/2"
Reading	0 ÷ 10 bar (0 ÷ 140 psi)

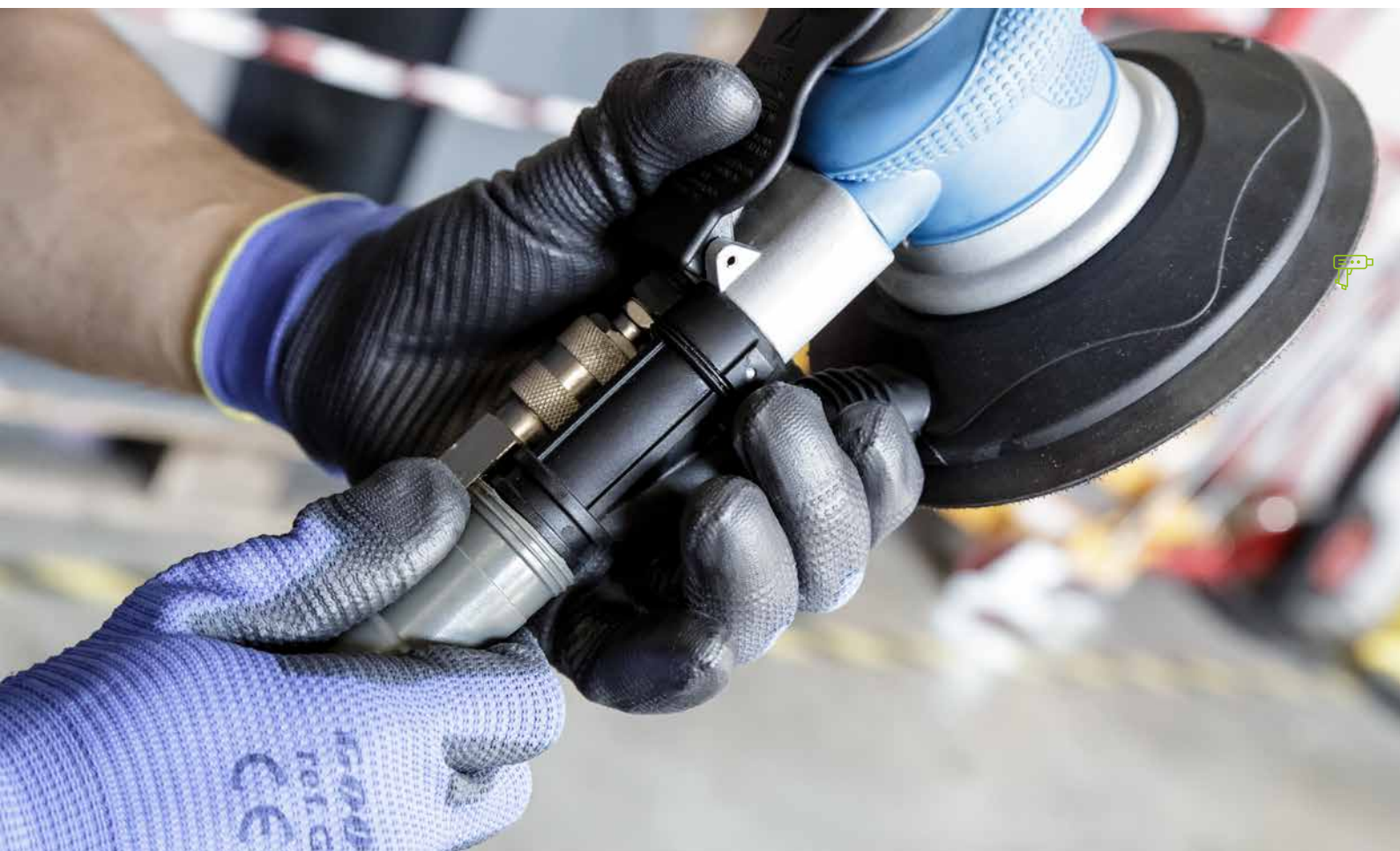

0793

€ 16,40

WOOD-BURNING PEN SET WITH 6 PINS OF DIFFERENT SHAPE



Power 230 V 50 Hz 30 W

0033A

CAT 42 € 90,80

HIGH PRECISION TEMPERATURE -CONTROLLED SOLDERING IRON STATION



Melting point	215°
Working temperature	215 + 300°C
Max temperature	420°C
Power station supply	230 V 50 Hz
Soldering power supply	24 V 48 W

0031

CAT 42 € 26,70

HIGH PRECISION TEMPERATURE -CONTROLLED SOLDERING IRON STATION



Melting point	215°
Working temperature	215 + 300°C
Max temperature	450°C
Power	230 V, 50 Hz, 37 W

0027/30W

CAT 42 € 10,30

SOLDERING IRON



Power	230 V 50 Hz 30 W
Working temperature	450°C ± 10%

0027/40W

CAT 42 € 11,70

SOLDERING IRON



Power	230 V 50 Hz 40 W
Working temperature	450°C ± 10%

0033A/TIP

CAT 42 € 14,60

SOLDERING IRON TIP SET

4 Pcs



0027/40W/TIP

CAT 42 € 14,60

SOLDERING IRON TIP SET

4 Pcs



0037

€ 15,90

SOLDERING IRON COMBINATION SET



Power 230V 50Hz 30W

0037/TIP

€ 13,00

SOLDERING IRON SPARE PART TIP

SET OF TIPS WITH HOLE Ø 6 mm



5 Pcs

0864

€ 36,50

GAS SOLDERING IRON

TIP AND SOLDER HEADS WITH PROTECTION CAP AND GAS IGNITER



Overall sizes 165 x 23 mm

0026

€ 16,20

SOLDERING GUN

WITH TIN AND A SPARE POINTER



Power 230 V 50 Hz 100 W

0443

€ 45,70

FAST HEATING SOLDERING GUN

WITH ADJUSTABLE TEMPERATURE



Blow mold case

Power 230V 50Hz 200W
 Temperature 70 °C ÷ 500 °C
 Weight 1350 g

0024

€ 24,40

HOT AIR GUN



2 speeds 375 °C - 495 °C
 Air stream 280 l/min - 480 l/min
 Power 230 V 50Hz 1,5 kW

COMPATIBILITY CHART

ART.	0033A/TIP	0027/40W/TIP	0037/TIP
0033A	•		
0027/30W	•		
0027/40W		•	
0037			•



0694

€ 36,20

HOT AIR GUN SET



Blow mold case

2 speeds	300 °C - 600 °C
Air stream	500 l/min - 650 l/min
Power	230 V 50 Hz 1 - 2 kW

0865

€ 51,50

ELECTRIC BARBECUE LIGHTER

LIGHTS CHARCOAL ON THE BARBECUE OR IN THE FIREPLACE COMPLETELY WITHOUT CHEMICALS AND MATCHSTICKS. HIGH-PERFORMANCE 2000 W BARBECUE AND FIREPLACE LIGHTER GENERATES 600°C HEAT AND SETS CHARCOAL ON FIRE IN APPROX. 30 - 60 SECONDS



Color box

Power	230 V, 50 Hz, 2000 W
Temperature	600° C
Weight	1 kg

0444

€ 68,20

DIGITAL HOT AIR GUN SET

WITH ELECTRONIC TEMPERATURE CONTROL, LCD DISPLAY TO SHOW THE TEMPERATURE, 2 LEVELS OF AIR FLOW, IDEAL FOR HEATING, FOLDING, BENDING, REMOVING PAINT



Power	230 V, 50 Hz, 2000 W
Temperature	I 70°C - II 70°C ÷ 600°C - III 70°C ÷ 600°C
Air stream	I 300L/min - II 300L/min - III 500L/min
Weight	735 g

0441

€ 56,70

HOT KNIFE FOR POLYSTYRENE WITH ADJUSTABLE TEMPERATURE

FOR POLYSTYRENE, PLASTIC, FOAM AND SPONGE, ADJUSTABLE CUTTING LENGTH, METAL STAND



Power	230 V, 50 Hz, 220 W
Temperature	120 - 220 - 330 - 400 - 450 °C
Cutting capacity with adjustment	20 ÷ 90 mm
Max cut	150 mm
Weight	770 g



0321

€ 38,60

HOT KNIFE FOR POLYSTYRENE WITH ADJUSTABLE TEMPERATURE
FOR POLYSTYRENE, PLASTIC, FOAM AND SPONGE, ADJUSTABLE CUTTING LENGTH, METAL STAND



Power	230 V, 50 Hz, 130 W
Temperature	Max 450 °C
Cutting capacity with adjustment	14 ÷ 97 mm
Max cut	120 mm
Weight	0,72 kg

0706

€ 29,60

GLUE GUN TRIGGER FEED



Power	230 V 40W 300 °C
Glue stick	ø 12 mm

0508

€ 10,20

GLUE GUN TRIGGER FED
EQUIPPED WITH AUTOMATIC ADVANCE



Power	230 V 28 W 160 °C
Glue stick	ø 12 mm

0333

€ 90,10

HOT KNIFE FOR POLYSTYRENE WITH ADJUSTABLE TEMPERATURE
FOR POLYSTYRENE, PLASTIC, FOAM AND SPONGE, ADJUSTABLE CUTTING LENGTH, METAL STAND



Power	230 V, 50 Hz, 150 W
Temperature	Max 500 °C
Max cut	150 mm
Weight	1.20 kg

0333/150

€ 14,60

SPARE BLADE



0431

€ 14,60

GLUE GUN TRIGGER FEED
EQUIPPED WITH AUTOMATIC ADVANCE AND LED FOR REPORTING THE GUN'S CONNECTION TO THE POWER GRID



Power	230 V, 35 W, 200 °C
Glue stick	ø 12 mm
Glue flow	16 ÷ 20 g/min
Weight	413 g

0034

€ 4,12

HOT MELT GLUE STICKS

10 Pcs

Dimensions ø 12 x 200 mm Tot. 200 gr



0071

€ 4,35

HOT MELT GLUE STICKS

10 Pcs

Overall sizes ø 12 x 200 mm 200 gr



0156-

FLEXIBLE OIL-CAN



Art.	€	Capacity
0156/200	€ 4,75	200 cc
0156/500	€ 5,90	500 cc

0164/250

€ 6,20

PLASTIC OILER WITH VERTICAL FLEXIBLE SPOUT



Capacity	250 cc
----------	--------

0171-

MEASURING JUG

WITH FLEXIBLE SPOUT, SCREW COVER AND ANTI-DRIPPING END CAP



Plastic

Art.	€	Capacity
0171/2	€ 8,90	2 l
0171/3	€ 8,80	3 l
0171/5	€ 12,00	5 l

0158/500

€ 7,20

PLASTIC OILER WITH FLEXIBLE SPOUT



Capacity	500 cc
----------	--------

0473-

OIL DRAIN PAN

WITH POURING SPOUT AND HANDLES, MADE OF HIGH DENSITY POLYETHYLENE, IMPACT RESISTANT



Art.	€	Capacity	Dimensions	Weight
0473/10	€ 15,50	10 l	Ø400 x 120h mm	0,83 kg
0473/15	€ 16,90	15 l	Ø500 x 130h mm	1 kg

0183/750

€ 2,85

PLASTIC CAN WITH SPOUT

PLASTIC CAN WITH SPOUT



Capacity	750 cc
----------	--------



0172/150

€ 6,80

PLASTIC FUNNEL

WITH DIAMETER DI Ø 150 mm, CLOSING SCREW, FLEXIBLE SPOUT, ANTI-DRIPPING TOP/END COVERS AND UPPER HANDLE FOR THE HANGING



Diameter	Ø150 mm
Height	435 mm

0677

€ 32,40

HAND OPERATED LEVER GREASE GUN

COMPOSED OF METAL TANK AND PUMP, COUPLER AND 450 mm PVC FLEXIBLE HOSE FOR USING Ø 55 mm GREASE CARTRIDGES OR LOOSE GREASE (ADAPTOR ALREADY MOUNTED)

Box

Capacity	1000 cc
Flexible hose sizes	Ø 9 x 450 mm
Weight	2 kg

0677/CG

€ 8,40

GREASE CARTRIDGE
Box

Capacity	650 cc
Overall sizes	Ø 55 mm

0677/500

€ 14,20

500 CC HAND OPERATED LEVER GREASE GUN

COMPOSED OF METAL TANK AND PUMP, COUPLER AND 300 mm PVC FLEXIBLE HOSE, FOR USIGN WITH LOOSE GREASE OR Ø 53 mm GREASE CARTRIDGES

Box

Capacity	500 cc
Flexible hose sizes	Ø 8 x 300 mm
Working pressure	6000-8000 psi
Weight	1,3 kg

0677/IA

€ 221,00

AIR OPERATED GREASE GUN

TO BE USED WITH Ø 55 mm CARTRIDGE OR LOOSE GREASE WITH 2 GREASE CARTRIDGES, 400 mm REINFORCED HOSE INCLUDED AND 4 JAW ADJUSTABLE FITTING

Box

Capacity	800 cc
Overall sizes	Ø 60 x 500 mm
Working pressure	4 - 6 bar

0677/SO

€ 22,60

PLASTIC SUCTION DISCHARGE GUN
Box

Capacity	500 g
Overall sizes	Ø 50 x 500 mm



G030-

CAT 42

EMULSIFYING OIL



Art.	€	Quantity
G030/01	€ 9,90	1 l
G030/05	€ 40,00	5 l
G030/25	€ 190,00	25 l

S401/00

CAT 42 € 6,20

MULTI-FUNCTION SPRAY



Capacity 400 ml

S401/01

€ 5,20

COLD GALVANIZER

WITH HIGH MOLECULAR WEIGHT, PAINTABLE



Capacity 400 ml

S401/02

€ 4,69

MULTIPURPOSE GREASE

HIGH QUALITY SAPONIFIED GREASE MIXTURE



Capacity 400 ml

S401/03

€ 4,20

SOLVENT AND RELEASING

PENETRATING FLUID WITH HIGH SOLVENT AND RELEASING POWERS



Capacity 400 ml

S401/04

€ 4,56

PURE SILICONE OIL

BASED SOLUTION WITH ANTI-ADHESIVE, DETACHING AND LUBRICATING PROPERTIES ON MANY DIFFERENT MATERIALS



Capacity 400 ml



S401/05

€ 4,50

WELDING ANTIADHESIVE

A PRODUCT MADE OF FILM-FORMING SYNTHETIC POLYMERS WHICH OWNING THEIR SPECIAL CHARACTERISTICS PREVENT THE SEIZURE OF WELDING SPATTER TO ANY SURFACE



Capacity 400 ml

S401/06

€ 7,50

SPRAY STAINLESS STEEL

PROTECTIVE COVER BASED ON PURE STAINLESS STEEL



Capacity 400 ml

S401/08

€ 7,90

DRY PT FE LUBRICATING AGENT

PENETRATING FLUID WITH HIGH SOLVENT AND RELEASING POWERS



Capacity 400 ml

S401/09

€ 5,70

COPPER GREASE

LUBRICATING AND PROTECTING ACTION AT VERY HIGH TEMPERATURES



Capacity 400 ml

S401/10

€ 5,30

CUTTING OIL

MIXTURE OF MINERALS OILS WITH HIGH LUBRICATING QUALITY, IDEAL FOR DRILLING, THREADING AND CUTTING STAINLESS STEEL AND OTHER HARD METALS



Capacity 400 ml

S401/11

€ 4,00

AIR CLEAN

SUITABLE FOR CLEANING DELICATE OBJECT SUCH AS LENS, OBJECTIVES, COMPUTERS AND ANY KIND OF MECHANISM



Capacity 400 ml



S401/12

€ 4,38

DE-OXIDIZING AGENT FOR ELECTRIC CONTACTS

A SPECIFIC PRODUCT SUITABLY DESIGNED TO PROTECT ELECTRICAL EQUIPMENT AND ELECTRIC CONTACTS, IN GENERAL, FROM OXIDATION



Capacity 400 ml

S401/13

€ 4,88

VASELINE OIL

PURE



Capacity 400 ml

S401/07

CAT 42 € 4,33

BRAKE CLEANER, CARBURETORS AND THROTTLE BODIES



Capacity 400 ml

S401/14

CAT 42 € 5,10

PURE ZINC



Capacity 400 ml

S401/15

CAT 42 € 5,30

ZINC ADHESIVE LUBRICANT FOR CHAINS



Capacity 400 ml

S401/16

CAT 42 € 5,20

LITHIUM GREASE



Capacity 400 ml



0660-**PLASTIC FUEL TANK**

WITH FLEXIBLE FILLER, "UN" CERTIFIED ACCORDING TO EUROPEAN DIRECTIVES



Art.	€	Capacity Liters	Dimensions	Weight
0660/05	€ 8,90	5	260 x 120 x 250h mm	540 g
0660/10	€ 12,90	10	330 x 160 x 300h mm	680 g
0660/20	€ 16,90	20	400 x 200 x 360h mm	1080 g

0189-**METAL FUEL TANK**

WITH FLEXIBLE FILLER, "UN" CERTIFIED ACCORDING TO EUROPEAN DIRECTIVES



Art.	€	Capacity Liters	Weight
0189/05C	€ 33,40	5	1,50 kg
0189/10C	€ 33,90	10	2,50 kg
0189/20C	€ 38,60	20	3,80 kg

0194x**FUEL CAN RUBBER GASKET****0194**

Art.	€	Description
0189/G	€ 1,44	Gasket for canisters
0194	€ 10,70	Metal spout
0194/G	€ 1,60	Spout gasket

0303**PRESSURE SPRAYER WITH BRASS LANCE PIPE**

WITH GAUGE AND FPM GASKETS

€ 34,10

Capacity

8 l

0356**TROLLEY PRESSURE SPRAYER WITH BRASS LANCE PIPE**

WITH FPM GASKETS

€ 50,00

Capacity

16 l

0274**PRESSURE SPRAYER WITH BRASS NOZZLE**

WITH FPM GASKETS

€ 6,60

Capacity

2 l



0289
€ 4,81
PRESSURE SPRAYER WITH BRASS NOZZLE

RUBBER GASKETS



Capacity	2 l
Weight	0,35 kg

P024/15
€ 49,40
ALUMINIUM LEVER ACTION HAND PUMP

ALUMINIUM LEVER ACTION OIL, DIESEL AND KEROSENE HAND PUMP, WITH STEEL PIPE Ø 20 X 820 mm WITH 1/2" GAS THREAD AND DELIVERY PLASTIC HOSE

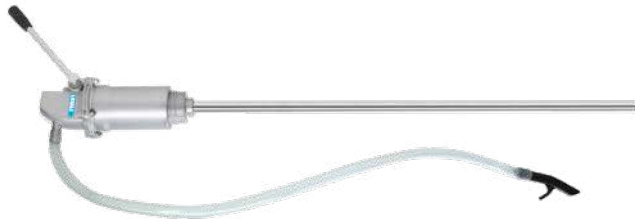
Box

Single stroke capacity	0.350 l
Capacity	15 l/min
Pump thread	2" / 1-1/2"
Weight	2.2 kg

0386
€ 30,80
LEVER ACTION HAND OIL PUMP

WITH TELESCOPIC PIPE

Box

Capacity	18 l/min
Pump thread	2" / 1-1/2"
Weight	2 kg

P024/06
€ 41,60
ALUMINIUM LEVER ACTION HAND PUMP

FOR OIL, DIESEL AND KEROSENE HAND PUMP, WITH STEEL PIPE Ø 16 X 700 mm WITH M16 X 1 THREAD AND DELIVERY PLASTIC HOSE

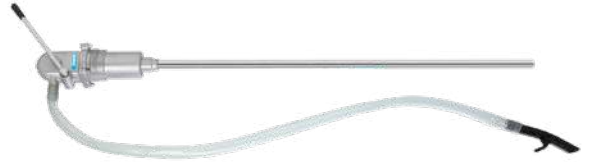
Box

Single stroke capacity	0.1 l
Capacity	6 l/min
Pump thread	2" / 1-1/2"
Weight	1.5 kg

0385
€ 43,10
ALUMINIUM ROTARY HAND OIL PUMP

WITH TELESCOPIC PIPE

Box

Capacity	20 l/min
Pump thread	2"
Weight	1,4 kg

0474/PP
€ 12,40
PVC DIESEL GUN

WITH Ø 25 mm NOZZLE



Capacity	60-80 l/min
Nozzle	ø25 mm
Inlet thread	1" BSP
Weight	0,8 kg

0474/PE

€ 23,90

ALUMINUM NOZZLE OIL GUN

WITH Ø 25 mm NOZZLE AND SWIVEL CONNECTOR



Capacity	60÷120 l/min
Nozzle	ø25 mm
Inlet thread	1" BSP
Weight	0,80 kg

0474/PA

€ 59,20

AUTOMATIC DIESEL GUN

WITH Ø 25 mm NOZZLE AND SWIVEL CONNECTOR



Capacity	90 l/min
Nozzle	ø25 mm
Inlet thread	1" BSP
Weight	1,4 kg

0755**12V DC DIESEL PUMP**

PUMP FOR MINERAL OIL AND DIESEL, MAXIMUM CONTINUOUS SERVICE 30 MIN

Base dimensions	200 x 120 x 110 mm
Motor	DC 12 V, 175 W
Motor speed	4500 rpm
Pump capacity	40 l/min
Hydraulic head	2 m
Suction	4 m
Inlet thread	25 mm
Weight	3.8 kg



€ 77,60

0272**DRILL PUMP**

FOR NO FLAMMABLE, EXPLOSIVE, CORROSIVE AND OILY LIQUID

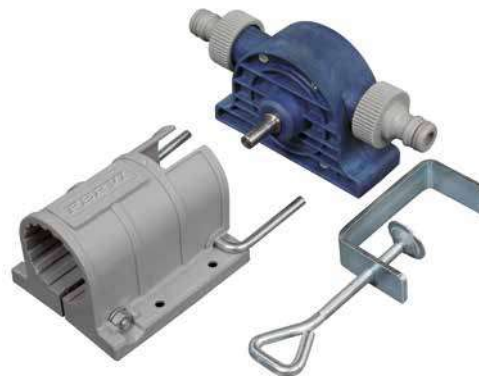

€ 11,60

Blister

Weight	450 g
--------	-------



R607

€ 87,60

1800 W INFRARED HEATER WITH SUPPORT FOR WALL MOUNTING
DUST AND WATER PROOF IP55, METAL HOUSING, WITH METAL NET-COVER



IP 55

Power	230 V, 1800 W
Weight	1,8 kg

R609

€ 93,60

1300 W INFRARED HEATER WITH SUPPORT FOR WALL MOUNTING
DUST AND WATER PROOF IP20, METAL HOUSING, WITH METAL NET-COVER, WITH R7S 1300W INFRARED BULB, 0.3M H07RN-F 3X1.5MM2 POWER CORD



Power	230 V, 1300 W
Weight	2,75 kg

R608

€ 197,00

2000 W INFRARED HEATER WITH SUPPORT FOR WALL MOUNTING
DUST AND WATER PROOF IP55, METAL HOUSING, WITH METAL NET-COVER AND REMOTE CONTROL



Power	230 V, 2000 W
Weight	3,0 kg

R610

€ 129,00

2000 W INFRARED HEATER WITH SUPPORT FOR WALL MOUNTING
DUST AND WATER PROOF IP20, METAL HOUSING, WITH METAL NET-COVER, WITH R7S 2000W INFRARED BULB, 0.3M H07RN-F 3X1.5MM2 POWER CORD



Power	230 V, 2000 W
Weight	3,2 kg

R60xA

TRIPOD ELECTRIC RADIANT INFRARED HEATER



IP 20

Art.	€	Power	Tripod height without heaters
R609A	€ 115,00	230 V 1,3 kW	600 ÷ 1500 mm
R610A	€ 165,00	230 V 2 kW	600 ÷ 1500 mm

R60xB

ELECTRIC RADIANT INFRARED HEATER WITH STAND



IP 20

Art.	€	Power
R609B	€ 118,00	230 V 1,3 kW
R610B	€ 155,00	230 V 2 kW

T609

€ 38,10

ADJUSTABLE HEIGHT TRIPOD

SUITABLE FOR LIGHT, HEATER



Height	600 ÷ 1500 mm
Upper fixing	M 8
Weight	2,3 kg

B609

€ 24,60

INFRARED BULB

230V, 1300 W

Length 250 mm



B610

€ 32,50

INFRARED BULB

230V, 2000 W

Length 340 mm



COMPATIBILITY CHART

ART.	€	R609	R610	R609A	R610A	R609B	R610B
B609	24,60	•		•		•	
B610	32,50		•		•		•
T609	38,10	•	•				

0218-

LED FLOODLIGHTS

ALUMINIUM SUPER SLIM DIE-CAST HOUSING, TEMPERED GLASS



65

Art.	€	Power	Intensity	LED number	Cable	Color temperature	Overall sizes
0218/10	€ 11,20	AC220-240V, 50Hz, 10W	800 lm	15 SMD LED	30 cm, H05RN-F 3x1.0 mm ² mm	4000° K	150 x 95 mm
0218/20	€ 16,30	AC220-240V, 50Hz, 20W	1600 lm	28 SMD LED	30 cm, H05RN-F 3x1.0 mm ² mm	4000° K	145 x 120 mm
0218/30	€ 26,60	AC220-240V, 50Hz, 30W	2400 lm	42 SMD LED	30 cm, H05RN-F 3x1.0 mm ² mm	4000° K	180 x 150 mm
0218/50	€ 37,80	AC220-240V, 50Hz, 50W	4000 lm	56 SMD LED	30 cm, H05RN-F 3x1.0 mm ² mm	4000° K	210 x 180 mm

0218/xB

CAT 42

10W LED FLOODLIGHT WITH STAND

ALUMINIUM SUPER SLIM DIE-CAST HOUSING, TEMPERED GLASS



65

Art.	€	Power	Intensity	Cable	Color temperature
0218/10B	€ 25,00	220 - 240 V, 50 Hz, 10W	800 lm	2 m, 3x1 mm ² H05VV-F	4000° K
0218/20B	€ 30,00	220 - 240 V, 50 Hz, 20W	1600 lm	2 m, 3x1 mm ² H05VV-F	4000° K
0218/30B	€ 39,20	220 - 240 V, 50 Hz, 30W	2400 lm	2 m, 3x1 mm ² H05VV-F	4000° K
0218/50B	€ 51,30	220 - 240 V, 50 Hz, 50W	4000 lm	2 m, 3x1 mm ² H05VV-F	4000° K



0218/xS

CAT 42

10W LED FLOODLIGHT WITH MOTION AND BRIGHTNESS SENSOR

ALUMINIUM SUPER SLIM DIE-CAST HOUSING, TEMPERED GLASS



IP 54

Art.	€	Power	Intensity	Cable	Color temperature
0218/10S	€ 21,70	220 - 240 V, 50 Hz, 10W	800 lm	30 cm, 3x1 mm ² H05VV-F	4000° K
0218/20S	€ 25,80	220 - 240 V, 50 Hz, 20W	1600 lm	30 cm, 3x1 mm ² H05VV-F	4000° K
0218/30S	€ 34,20	220 - 240 V, 50 Hz, 30W	2400 lm	30 cm, 3x1 mm ² H05VV-F	4000° K
0218/50S	€ 46,30	220 - 240 V, 50 Hz, 50W	4000 lm	30 cm, 3x1 mm ² H05VV-F	4000° K

0218/50T

CAT 42 € 74,20

10W LED FLOODLIGHT WITH TRIPOD

ALUMINIUM SUPER SLIM DIE-CAST HOUSING, TEMPERED GLASS



IP 65

Power	220 - 240 V, 50 Hz, 50W
Intensity	4000 lm
Cable	2 m, 3x1 mm ² H05VV-F
Color	4000° K

0713/15

€ 53,20

LED FLOODLIGHT WITH MAGNETIC BASE

12 AND 24 V 15 W, TO FIT ON CARS, OFFROADS, CAMPERS, BOATS, AGRICULTURAL MACHINES AND EARTHMOVING MACHINES, WITH 3 A FUSE AND CAR PLUG LIGHTER



Power	DC 9 ÷ 32 V (12 V, 24 V) 15 W
LED number	5 x 3 W 1050 lm
Lighting distance	5 m - 23 lux; 8,5 m - 10 lux
Color temperature	6000° K
Cable length	2 m
Projector size	108 x 108 mm
Base dimensions	ø 86,50 mm
Back holes center distance	87 x 28 mm M6
Overall dimensions	108 x 86,50 x 160 mm
Weight	0,55 kg

0713/18

€ 60,10

LED FLOODLIGHT WITH MAGNETIC BASE

12 AND 24 V 18 W, TO FIT ON CARS, OFFROADS, CAMPERS, BOATS, AGRICULTURAL MACHINES AND EARTHMOVING MACHINES, WITH 3 A FUSE AND CAR PLUG LIGHTER



Power	DC 9 ÷ 32 V (12 V, 24 V) 18 W
LED number	6 x 3 W 1260 lm
Lighting distance	5 m - 45 lux; 12 m - 10 lux
Color temperature	6000° K
Cable length	2 m
Projector size	ø 116 mm
Base dimensions	ø 86,50 mm
Back holes center distance	87 x 28 mm M6
Overall dimensions	116 x 86,50 x 165 mm
Weight	0,6 kg

0713/27

€ 92,70

LED FLOODLIGHT WITH MAGNETIC BASE

12 AND 24 V 27 W, TO FIT ON CARS, OFFROADS, CAMPERS, BOATS, AGRICULTURAL MACHINES AND EARTHMOVING MACHINES, WITH 3 A FUSE AND CAR PLUG LIGHTER



Power	DC 9 ÷ 32 V (12 V, 24 V) 27 W
LED number	9 x 3 W 1890 lm
Lighting distance	5 m - 85 lux; 15,5 m - 10 lux
Color temperature	6000° K
Cable length	2 m
Projector size	ø 116 mm
Base dimensions	ø 86,50 mm
Back holes center distance	87 x 28 mm M6
Overall dimensions	116 x 86,50 x 165 mm
Weight	0,8 kg

0343

€ 20,90

FLEXIBLE ARM LAMP



Box

Power	110 / 230 V 50 / 60 Hz max 40 W, E27
Range	800 mm
Clamp capacity	35 mm

0366

€ 92,70

48 LED MAGNIFIER LAMP



Box

Power	230 V 50 Hz 4,8 W
Magnification	2x
Lens	Ø 127 mm
Range	810 mm
Clamp capacity	70 mm

0530

€ 95,00

LOW CONSUMPTION LAMP

WITH LENS



Box

Power	230 V 50 Hz 22 W
Magnification	2x
Lens	Ø 120 mm
Range	810 mm
Clamp capacity	70 mm

0891

€ 143,00

LOW CONSUMPTION LAMP

WITH 2 LENS



Box

Power	230 V 50 Hz 2 x 9 W
Magnification	2x + 6x
Lens	190 x 157 mm
Range	810 mm
Clamp capacity	70 mm

0516

€ 131,00

LOW CONSUMPTION LAMP

WITH LENS



Box

Power	230V 50Hz 2 x 9W
Magnification	2x
Lens	190 x 157 mm
Range	810 mm
Clamp capacity	70 mm

0344

€ 26,90

FLEXIBLE ARM LAMP WITH MAGNIFYING LENS



Box

Power	230 V 50/60 Hz
Bulb not included	Max 60 W, E27
Magnification	2x
Lens	Ø 100 mm
Range	800 mm
Clamp capacity	35 mm



0661

€ 40,50

**TABLE LAMP
WITH LENS**



Box

Power	230 V 50 Hz 11 W
Magnification	2x
Lens	Ø 89 mm

0659

€ 30,80

CRYSTAL LENS SET



12 Pcs

Contents	Ingrandimenti/Magnifications
3 Pcs ø 50	3x - 10x mm
3 Pcs ø 60	3x - 8x mm
3 Pcs ø 75	3x - 8x mm
3 Pcs ø 90	3x - 8x mm

0625

€ 26,40

**HEAD LIGHT WITH MAGNIFYING
LEN SET**



Box

Multiplier	Distanza del fuoco mm/Target distance mm
1,2x	520 ÷ 620
1,8x	230 ÷ 320
2,5x	150 ÷ 250
3,5x	80 ÷ 120
Bulb	2,2 V - 0,25 A
Battery	2 AAA

0659-

CRYSTAL LENS



Art.	€	ø	Magnification
0659/50	€ 3,34	50 mm	3x - 10x
0659/60	€ 4,35	60 mm	3x - 8x
0659/75	€ 5,50	75 mm	3x - 8x
0659/90	€ 9,20	90 mm	3x - 8x

L005

€ 23,40

LED MAGNIFIER



Box

Lens	Ø 125 mm
Magnification	2x
LED	6 - 9000 mcd
Battery	4 AA

L006

€ 8,20

LED MAGNIFIER



Box

Lens	50 x 50 mm
Magnification	3x
LED	5 - 9000 mcd
LED	1
Battery	4 Ag10

0643-

**WATERPROOF PORTABLE
BATTERY LAMP**



Art.	€	Bulb	Not included batteries	Packing
0643/1	€ 4,35	Krypton	2 AA	B blister
0643/2	€ 6,60	Krypton	2 D	B blister
0643/3	€ 9,80	Krypton	3 D	B blister

0436

€ 15,50

WATERPROOF LED TORCH

DISTANCE CAPACITY MORE THAN 150 M,
LONG LIFE



Blister

Not included batteries	4 AA
LED power	3 W
Weight	200 g

0437

€ 19,60

HIGH POWERFUL LED TORCH

LONG RANGE , DISTANCE CAPACITY MORE THAN 150 M, LONG LIFE



Box

Not included batteries	4 C
LED power	3 W
Autonomy	25 h / 100 %
Weight	350 g

0491

€ 53,00

BIKE/POCKET LED FLASHLIGHT SET

MADE OF ABS AND RUBBER COVER, WITH CLAMP



12 Pcs Display box

Not included batteries	3 x AAA
LED number	9
Intensity	20 lm
Sizes	ø 36 x 36 x 105 mm
Autonomy	8 h
Weight	0,6 kg

0493/1

€ 7,30

LED HEADLIGHT

80 LM, MADE OF ABS AND RUBBER COVER, WITH ELASTIC BELT, 2 FUNCITONS: FOCUS AND FLASH, FOR USING WITH 3 BATTERIES AAA TYPE



Box

Not included batteries	3 x AAA
Intensity	80 lm
Sizes	ø 50 x 42 x 58 mm
Autonomy	10 h
Weight	0,096 kg

0480

€ 3,80

2PC BICYCLE LED LIGHT SET

MADE OF SILICON, 3 FUNCTIONS: FOCUS, FAST FLASH, SLOW FLASH



Blister

LED number	2, 400 - 500 mcd
Included batteries	2 x CR-2032
Weight	23 g

0482/3

CAT 42 € 45,00

HEAD LAMP WITH SENSOR



LED	3 W COB
Color temperature	6500 K
Battery	3.7 V 1500 mAh Li-ion
Autonomy	4h
Intensity	Max 300 lm
Recharging time	3h
Weight	110 g kg

0493/2

€ 18,90

LED HEADLIGHT

120 LM, WITH ELASTIC BELT, 2 FUNCITONS: FOCUS AND FLASH, FOR USING WITH 3 BATTERIES AAA TYPE



Box Aluminium

Not included batteries	3 x AAA
Intensity	120 lm
Sizes	ø 75 x 45 x 45 mm
Autonomy	5 h
Weight	0,136 kg



0209

€ 30,00

10 + 1 LED MAGNETIC WORK LIGHT

WITH ROTATING HEAD, LED ON THE TOP AND FRONT WITH 2 BRIGHTNESS LEVELS

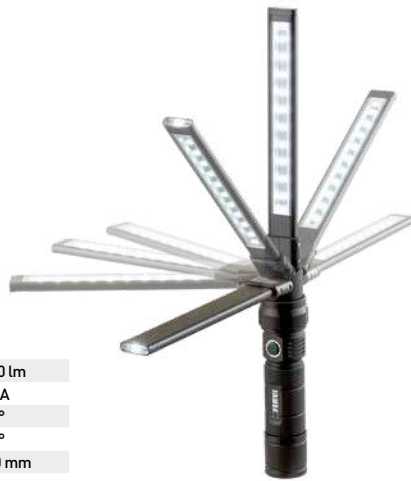

Intensity	50 - 300 lm
Not included batteries	3 AAA
Tilting head	180°
Revolution	180°
Dimensions	35 x 330 mm
Weight	208 g

0128

€ 8,70

12 + 1 LED POCKET TORCH LIGHT WITH MAGNET

AND SWIVEL CLIP, LONG LASTING, SMALL SIZE AND HIGH BRIGHTNESS MAKE IT ESSENTIAL IN PROFESSIONAL AND DO-IT-YOURSELF LINES



Included batteries	3 AAA
Sizes	174 x 3.4 x 2.2 mm
Intensity	30 lm
Weight	49 g

0397

€ 5,50

7 LED POCKET TORCH LIGHT

WITH MAGNETIC AND SWIVEL CLIP, LONG LASTING, SMALL SIZE AND HIGH BRIGHTNESS MAKE IT ESSENTIAL IN PROFESSIONAL AND DO-IT-YOURSELF LINES



Not included batteries	3 AAA
Sizes	33 x 16 x 160 mm

0671/8

€ 11,10

ALUMINUM WHITE LED FLASHLIGHT WITH EXTRA BRIGHTNESS



Blister	
Not included batteries	2 AA
LED number	8 - 9000 mcd
Sizes	Ø 25 x 20 x 140 mm

0671/1P

€ 5,60

ALUMINUM WHITE LED FLASHLIGHT WITH EXTRA BRIGHTNESS



Blister	
Not included batteries	2 AAA
LED number	1 - 9000 mcd
Sizes	Ø 12,5 x 141 mm

0787

€ 16,80

ALUMINUM TORCH



Blister	
Not included batteries	2 C
LED number	8 LED 11000 mcd
Sizes	Ø 48,5 x 31 x 215 mm



0492

€ 56,20

LED FLASHLIGHT SET WITH TELESCOPIC MAGNET

MADE OF ALUMINUM



6 Pcs Display box

Button batteries	4-LR44
LED number	6
Intensity	6 x 10 lm
Sizes	ø 30 x 21 x 180 mm
Max length	710 mm
Autonomy	3 h
Weight	0,12 kg

0107

€ 6,30

30 + 7 LED MAGNETIC LIGHT

WITH MAGNET AND HOOK ON THE BACK SIDE



ABS

Single LED life	100000 hours
Intensity	50 lm
Not included batteries	3 AA
Dimensions	40 x 35 x 203 mm
Weight	130 g

0311

€ 8,90

24 LED MAGNETIC LIGHT

WITH MAGNET AND HOOK ON THE BACK SIDE



ABS

Single LED life	100000 hours
Not included batteries	3 AA

0291

€ 7,30

24 + 3 LED MAGNETIC LIGHT

WITH MAGNET AND HOOK ON THE BACK SIDE



ABS

Single LED life	100000 hours
Not included batteries	3 AAA

0338

€ 33,40

ALUMINUM HAND TORCH WITH 1 LED AND MANUAL ZOOM

3 LIGHT TYPES: STRONG, MEDIA AND FLASHING; ADAPTER TO WORK WITH 3 BATTERIES AAA TYPE IN A BOX



Battery	1 lithium (rechargeable), 3 AAA
LED	Q3 3 W
Sizes	ø 34,5 x 28 x 135 mm
Battery charger	110 / 230 V 50 / 60 Hz
Autonomy	4 h
Weight	350 g

0597

€ 23,20

RECHARGEABLE LED LIGHT WITH MAGNET

WITH BATTERY CHARGER DC12V AND AC 230V, FOLDABLE, HANGING AND MAGNETIC



Battery	3.7 V 1800 mAh
LED	8 SMD + 5 LED
Recharging time	8 ÷ 10 h
Autonomy	7 ÷ 8 h
Weight	0,55 kg



0889

€ 47,90

RECHARGEABLE LED LIGHT WITH MAGNET

WITH BATTERY CHARGER DC12V AND AC 230V, FOLDABLE, HANGING AND MAGNETIC



Box

Battery	3,7 V - 1100 mAh - Lithium
LED	21 + 5 - 9000 mcd
Recharging time	4 ÷ 5 h
Autonomy	4 ÷ 6 h

0401

€ 58,30

COB LED TECHNOLOGY RECHARGEABLE LAMP

HIGH CAPACITY LITHIUM BATTERY FOR LONG TIME OPERATION, MAGNETIC BACK FOR HAND-FREE APPLICATION, FLEXIBLE STANDING ARM FOR MULTI-ANGLE LIGHTING PURPOSES, STRONG LIGHT OUTPUT 180 LUMENS



Box

Power	100 ÷ 240 V , 50 ÷ 60 Hz
Battery	3,7 V 2 x 2000 mAh Lithium
Recharging time	6 h
Autonomy	3,5 h
Weight	550 g

0693

€ 95,00

RECHARGEABLE LED LAMP



Box

Battery	7,4 V - 1900 mAh - Lithium
LED	30 - 9000 mcd
Recharging time	5 ÷ 6 h
Autonomy	8 h

0123

€ 49,10

MULTIFUNCTION USB RECHARGEABLE LED LIGHT

WITH FRONT TORCH WITH VARIOUS STEPS OF BRIGHTNESS, LATERAL WHITE AND RED LEDS WITH FLASHING FUNCTION. USB RECHARGING CABLE AND TRANSFORMER. CHARGE AND RECHARGE STATUS LED. IT CAN BE CHARGED DIRECTLY FROM A COMPUTER.



Battery	1 lithium (rechargeable) 3.7V, 1800 mAh
LED	24 Cree XPG R5
Intensity	30 - 300 lm
Dimensions	191 x 99 x 148 mm
Battery charger	USB 110 - 230 V 50 - 60 Hz
Autonomy	2.5 h
Weight	386 g

L008

€ 101,00

SLIM INSPECTION CORDLESS LED LIGHT

RECHARGEABLE, HIGH CAPACITY LITHIUM BATTERY FOR LONG TIME OPERATION, STRONG LIGHT OUTPUT 400 LUMEN, THE SLIM DESIGN AND ROBUST STRUCTURE MAKE IT INDESTRUCTIBLE EVEN IF IT FALLS FROM A HEIGHT OF ONE METER OR, IF IT IS FORGOTTEN ON A FLAT FLOOR, THE CAR PASSES OVER IT



Box

Power	100 ÷ 240 V , 50 ÷ 60 Hz
Battery	3,7 V 2400 mAh Lithium
Recharging time	3,5 h
Autonomy	3 - 10 h
Weight	115 g



0445/20

€ 124,00

20W 600/1450 LM RECHARGEABLE LED FLOODLIGHT

WITH SWITCH TO WORK AT 600 LM, ADAPTERS TO RECHARGE BATTERIES WITH CAR DC LIGHTER AND HOME AC 230 V



IP 65

Power	DC 12 - 24 V, 20 W; AC 230 V 20W
Intensity	600 - 1450 lm
Battery	7.4V Li-Ion, 5400mAh
Autonomy	3 - 6 h
Weight	1,5 kg

0429

€ 20,40

WORKING LAMP HOLDER WITH 5 M POWER CORD

WITHOUT ON/OFF SWITCH, MAX 60 W FOR INCANDESCENT LAMPS, E27 SCREW CUP BULB, VOLTAGE RANGE 12 ÷ 230 V; BULB NOT INCLUDED



Hanger IP54

Cable length	5 m
Screw cup bulb	E27
Voltage	230 V
Weight	1000 g

0342

€ 13,30

PORTABLE NEON LAMP WITH HOOK



Blister

Power	230 V 50 Hz 8 W
Dimensions	ø 31 x 435 mm
Cable	5 m

0840

€ 95,00

RECHARGEABLE LED LAMP WITH ADJUSTABLE HOOKS AND MAGNETS

MADE OF ABS AND POLYCARBONATE, WITH LITHIUM BATTERY, 12 V CAR PLUG ADAPTER AND 230 V HOME ADAPTER, CHARGING INDICATOR LIGHT



Power	DC 12 V 7,2 W; AC 230V
Working lamp dimensions	ø 38 x 1080 mm
Adjustable extension clamps	1210 ÷ 1950 mm
Battery	7.4 V, 1800 mAh Lithium
Intensity	900 lm, 36 SMD
Recharging time	4 - 5 h
Autonomy	3h



0621/A3

€ 85,50

AUTO RE-ENTERING CABLE REEL



Box

Without lamp	
Cable length	10 m
Cable type	3 x 1,50 mm ² H05VV-F
Power	12 V ÷ 240 V
Max power for rolled cable	1200 W
Max power for unrolled cable	1800 W

A010-x

CABLE REEL

COMPLIES WITH STANDARD EN61242, DOUBLE ISOLATION CABLE H05VV-F HOMOLOGATED, HOMOLOGATED PVC PRESSURE-CAST PLUG, THERMAL CIRCUIT BREAKER WITH MANUAL RESET, MAX. POWER WITH ROLLED CABLE 1,2 KW, MAX. POWER WITH UNROLLED CABLE 3,4 KW



Art.	€	Cable length	Section	Drum
A010/10	€ 31,40	10 m	3 x 1,5 mm ²	ø 200 mm
A010/20	€ 51,00	20 m	3 x 1,5 mm ²	ø 250 mm

0428

€ 90,10

AUTOMATIC CABLE REEL WITH LAMP HOLDER

OVERLOAD PROTECTION, CABLE REEL IP20, MAX 60 W FOR INCANDESCENT LAMPS, E27 SCREW CUP BULB, LED LIGHT ON THE CABLE REEL TO SHOW THE PRESENCE OF POWER, VOLTAGE RANGE 12 ÷ 230 V; BULB NOT INCLUDED



Box

Cable size	13 + 1 m - H05RR-F - 2 x 1mm ²
Screw cup bulb	E27
Voltage	12 ÷ 230 V
Weight	3,2 kg

A010-

CABLE REEL

COMPLIES WITH STANDARD EN61242, DOUBLE ISOLATION CABLE H05VV-F HOMOLOGATED, HOMOLOGATED PVC PRESSURE-CAST PLUG, THERMAL CIRCUIT BREAKER WITH MANUAL RESET, MAX. POWER WITH ROLLED CABLE 1,2 KW, MAX. POWER WITH UNROLLED CABLE 3,4 KW



Art.	€	Cable length	Section	Drum
A010/15	€ 45,70	15 m	3 x 1,5 mm ²	ø 190 mm
A010/25	€ 66,10	25 m	3 x 1,5 mm ²	ø 240 mm
A010/50	€ 118,00	50 m	3 x 1,5 mm ²	ø 310 mm



A010/20G

€ 47,20

GARDEN CABLE REEL

20 M COMPLIES WITH STANDARD EN61242, DOUBLE ISOLATION CABLE H05VV-F HOMOLOGATED, HOMOLOGATED SCHUKO PLUG AND SCHUKO SOCKET, THERMAL CIRCUIT BREAKER WITH MANUAL RESET, MAX. POWER WITH ROLLED CABLE 1.2 KW, MAX. POWER WITH UNROLLED CABLE 3.4 KW



Cable length	20 m
Section	3 x 1 mm ²
Drum	ø 250 mm

A010/30T

€ 296,00

CABLE REEL

COMPLIES WITH STANDARD EN61316, FLEXIBLE CORD H07RN-F, NEOPRENE HOMOLOGATED, IP44 PLUGS, THERMAL CIRCUIT BREAKER, WITH MANUAL RESET, MAX. POWER WITH ROLLED CORD 5 KW, MAX. POWER WITH UNROLLED CORD 11 KW



Power	380 V
Cable length	30 m
Section	4 x 2,5 mm ²
Drum	ø 340 mm

0651/6

€ 10,30

6 ITALIAN AND GERMAN TYPE POWER SOCKET AND ITALIAN PLUG 16A

WITH OVERLOAD PROTECTION



Cable	3 x 1 mm ²
Cable length	1,5 m

A010/30

€ 215,00

CABLE REEL

CONFORM TO STANDARD EN61316, FLEXIBLE CORD H07RN-F NEOPRENE HOMOLOGATED, IP44 PLUGS, THERMAL CIRCUIT BREAKER WITH MANUAL RESET, MAX. POWER WITH ROLLED CORD 5 KW MAX. POWER WITH UNROLLED CORD 11 KW



Power	230 V
Cable length	30 m
Section	3 x 2,5 mm ²
Drum	ø 340 mm

0651/5

€ 9,60

5 ITALIAN AND GERMAN TYPE POWER SOCKET AND ITALIAN PLUG 16A



Cable	3 x 1 mm ²
Cable length	1,5 m

0651/6S

€ 9,80

6 ITALIAN AND GERMAN TYPE POWER SOCKET, WITH OVERLOAD PROTECTION AND GERMAN PLUG

WITH OVERLOAD PROTECTION



Cable	3 x 1 mm ²
Cable length	1,5 m



GI01/32AE

€ 1820,00

INVERTER GENERATOR WITH ELECTRIC STARTER AND WHEELS

3,5 KVA SILENCED INVERTER, CONSISTING OF STRONG IRON AND PLASTIC ELEMENTS, WITH ELECTRIC STARTER WITH REMOTE CONTROL, TRANSISTORISED IGNITION SYSTEM, AC CIRCUIT BREAKER, OIL SENSOR BREAKER AND AIR COOLING SYSTEM

Power	230 V 50 Hz 3,5 kVA
Rated AC output	3,1 kVA
Rated DC Output	12 V / 8,3 A
Frequency	50 Hz
Tension	230 V
Fuel tank capacity	6 l
Fuel	Benzina verde
Power outlet	Schuko
Dimensions	571 x 436 x 462 mm
Displacement-EngineType	161 cc - 4 tempi, OHV
Max engine power Output	4,5 kW / 4000 rpm
Noise Level	61 dB(A) a 7m
Weight	43 kg

GI01/32

€ 1620,00

INVERTER GENERATOR WITH WHEELS

3,5 KVA SILENCED INVERTER, CONSISTING OF STRONG IRON AND PLASTIC ELEMENTS, WITH TRANSISTORISED IGNITION SYSTEM, AC CIRCUIT BREAKER, OIL SENSOR BREAKER AND AIR COOLING SYSTEM

Power	230 V 50 Hz 3,5 kVA
Rated AC output	3,1 kVA
Rated DC Output	12 V / 8,3 A
Frequency	50 Hz
Tension	230 V
Fuel tank capacity	6 l
Fuel	Benzina verde
Power outlet	Schuko
Dimensions	571 x 436 x 462 mm
Displacement-EngineType	161 cc - 4 tempi, OHV
Max engine power Output	4,5 kW / 4000 rpm
Noise Level	61 dB(A) a 7m
Weight	43 kg

GI01/20

€ 1210,00

INVERTER GENERATOR

2 KVA SILENCED INVERTER, CONSISTING OF STRONG IRON AND PLASTIC ELEMENTS, WITH TRANSISTORISED IGNITION SYSTEM, AC CIRCUIT BREAKER, OIL SENSOR BREAKER AND AIR COOLING SYSTEM

Max power	2 kVA
Rated AC output	1,6 kVA
Rated DC Output	12 V / 8,3 A
Frequency	50 Hz
Tension	230 V
Fuel tank capacity	3,8 l
Fuel	Benzina verde
Power outlet	Schuko
Dimensions	490 x 335 x 415 mm
Displacement-EngineType	80 cc - 4 tempi, OHV
Max engine power Output	2,5 kW / 5500 rpm
Noise Level	60 dB(A) a 7m
Weight	24,5 kg



0678

€ 16,00

POLYURETHANE FOAM GUN

MOUNT AND FOAM ADJUSTMENT



Color box

Length 290 mm

0085

€ 9,80

9" HEAVY DUTY CAULKING GUN



Weight 700 g

0521

€ 7,90

9" HEAVY DUTY CAULKING GUN



Weight 600 g

0234

€ 3,43

9" REINFORCED CAUL KING GUN SKELETON TYPE EXAGONAL ROD



Weight 380 g

0091

€ 2,99

9" RATCHET CAUL KING GUN BARREL TYPE



Weight 380 g

0604

€ 16,00

9" EPOXY SEAL CAUL KING GUN

345 ML AND 235 ML

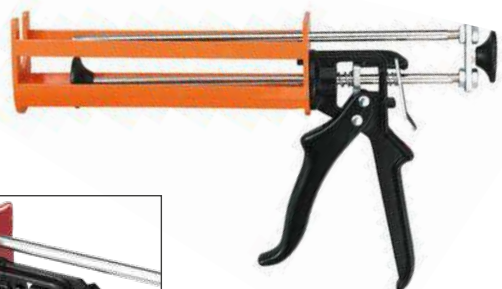

Weight 1000 g

0861

€ 16,00

9" EPOXY SEAL CAULKING GUN

380 ML



Weight 950 g

0820-

SQUARE TROWELS



Art.	€	Length
0820/18	€ 3,86	180 mm
0820/20	€ 4,00	200 mm

0822

€ 4,28

PLASTERING TROWEL WITH ABS HANDLE



Length 280 x 120 mm

0184-

PUTTY KNIFE WITH CLIPPED PLASTIC HANDLE MIRROR POLISH



Art.	€	Blade sizes
0184/01	€ 1,19	30 x 90h mm
0184/02	€ 1,19	50 x 95h mm
0184/03	€ 1,54	75 x 100h mm
0184/04	€ 2,36	100 x 100h mm

0819-

BRICKLAYING TROWELS ROUND NOSE



Art.	€	Length
0819/18	€ 3,86	180 mm
0819/20	€ 4,00	200 mm

0821/14

€ 2,99

BRICKLAYING TROWEL ROUND NOSE



Length 140 mm

0823

€ 4,28

NOTCHED TROWEL WITH ABS HANDLE



Length 280 x 120 mm

0606

€ 3,48

POLYETHYLENE BUCKET



Overall sizes	ø 360 x 240h mm
Capacity	14 l
Weight	720 g

0043

€ 4,55

RED AND WHITE SIGNAL TAPE



Length 200 m
Height 70 mm

0747

€ 2,01

PPL TAPE HAVANA COLOR



Belt dimensions 50 mm x 66 m

PVC300/125

€ 4,12

PPL FILM



Dimensions 0,125h x 100 m
Thickness 20 µm

PVC300

€ 15,60

PPL FILM



Dimensions 0,5h x 300 m
Thickness 23 µm

0103

€ 6,90

TAPE FILM DISPENSER



0760

€ 6,90

STRETCH FILM HANDLE DISPENSER



0748

€ 8,20

PPL FILM HANDLE DISPENSERS

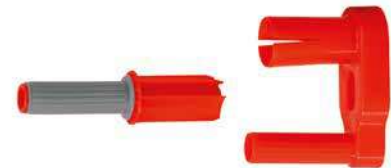

028x

POLYETHYLENE PROTECTION COVER SHEET, TWO COLOURS: GREEN - BLUE

PROTECTED TO UV RAYS, WOVEN POLYETHYLENE TARPAULIN 140/150 G/M2, EYELETS EVERY 50 CM



Art.	€	Dimensions	Weight
0281	€ 9,40	2 x 3 m	0,8 kg
0282	€ 27,20	4 x 5 m	2,8 kg
0283	€ 54,30	5 x 8 m	5,6 kg
0284	€ 70,80	6 x 10 m	8,4 kg

GL642-

COW GRAIN LEATHER GLOVE

HEMMED WITH INTERNAL ELASTIC CUFF



PACKING OF 12* PAIRS

Art.	€	Size
GL642/07	€ 5,30	7
GL642/08	€ 5,30	8
GL642/09	€ 5,30	9
GL642/10	€ 5,30	10
GL642/11	€ 5,30	11

GL814-

COW GRAIN/SPLIT LEATHER GLOVE

EXTRA-QUALITY, WING THUMB, COW GRAIN LEATHER PALM, COW SPLIT BACK. HEMMED WRIST WITH INTERNAL ELASTIC CUFF



PACKING OF 12* PAIRS

Art.	€	Size
GL814/07	€ 4,55	7
GL814/08	€ 4,55	8
GL814/09	€ 4,55	9
GL814/10	€ 4,55	10
GL814/11	€ 4,55	11

GL349-

NBR COATED COTTON JERSEY GLOVE

PALM, FINGERS AND KNUCKLES COATED, LIGHTWEIGHT, GOOD ABRASION RESISTANCE, KNITWRIST CUFF AND PARTIALLY AERATED BACK



PACKING OF 12* PAIRS

Art.	€	Size
GL349/07	€ 1,63	7
GL349/08	€ 1,63	8
GL349/09	€ 1,63	9
GL349/10	€ 1,63	10
GL349/11	€ 1,63	11

GL650-

SHEEP GRAIN LEATHER-COTTON GLOVE

SHEEP GRAIN LEATHER PALM, STRETCH COTTON BACK, CUFF ADJUSTABLE WITH VELCRO



PACKING OF 12* PAIRS

Art.	€	Size
GL650/08	€ 6,70	8 - Blue
GL650/09	€ 6,70	9 - Yellow
GL650/10	€ 6,70	10 - Red
GL650/11	€ 6,70	11 - Black

GL345-

NBR COATED COTTON JERSEY GLOVE

PALM, FINGERS AND KNUCKLES COATED, EXCELLENT RESISTANCE TO ABRASION, GREASE AND OIL, HYDROCARBONS AND DIRT, COTTON CANVAS SAFETY CUFF



PACKING OF 12* PAIRS

Art.	€	Size
GL345/09	€ 2,75	9
GL345/10	€ 2,75	10

GL373-

SEAMLESS POLYESTER GLOVE / NITRILE

PALM COATED WITH NITRILE FOR GOOD PROTECTION IN THE PRESENCE OF LIQUIDS, OILS AND/OR GREASE, EXCELLENT ABRASION RESISTANCE, ERGONOMIC DESIGN FOR A COMFORTABLE FIT, KNITWRIST CUFF AND BREATHABLE BACK



PACKING OF 12* PAIRS

Art.	€	Size
GL373/07	€ 1,32	7
GL373/08	€ 1,32	8
GL373/09	€ 1,32	9
GL373/10	€ 1,32	10



GL365-**SEAMLESS POLYESTER GLOVE / NITRILE**

PALM COATED WITH NITRILE FOR GOOD PROTECTION IN THE PRESENCE OF LIQUIDS, OILS AND/OR GREASE, EXCELLENT ABRASION RESISTANCE, ERGONOMIC DESIGN FOR A COMFORTABLE FIT, KNITWRIST CUFF



PACKING OF 12* PAIRS

Art.	€	Size
GL365/08	€ 2,82	8
GL365/09	€ 2,82	9
GL365/10	€ 2,82	10

GL764-**SEAMLESS POLYESTER GLOVE/POLYURETHANE**

PALM COATED WITH POLYURETHANE, SUPERIOR DEXTERITY AND TACTILE SENSITIVITY, LIGHTWEIGHT, FLEXIBLE, WITH EXCELLENT ABRASION AND WEAR RESISTANCE, ERGONOMIC DESIGN FOR A COMFORTABLE FIT, KNITWRIST CUFF AND BREATHABLE BACK



PACKING OF 12* PAIRS

Art.	€	Size
GL764/07	€ 1,37	7
GL764/08	€ 1,37	8
GL764/09	€ 1,37	9
GL764/10	€ 1,37	10

GL516-**SEAMLESS NYLON GLOVE / LATEX**

PALM COATED WITH LATEX, WRINKLE FINISH FOR EXTRAORDINARY DRY & WET GRIP, ERGONOMIC DESIGN FOR A COMFORTABLE FIT, KNITWRIST CUFF AND BREATHABLE BACK



PACKING OF 12* PAIRS

Art.	€	Size
GL516/08	€ 2,85	8
GL516/09	€ 2,85	9
GL516/10	€ 2,85	10

GL722-**SEAMLESS NYLON GLOVE / POLYURETHANE**

PALM COATED WITH A SPECIAL ULTRALIGHT POLYURETHANE COMPOUND, EXTRA LIGHTWEIGHT AND ELASTIC WITH HIGH TACTILE SENSITIVITY AND DEXTERITY, EXCELLENT DRY & WET GRIP, WITH ANTIBACTERIAL SANITIZED® TREATMENT, ERGONOMIC DESIGN FOR A COMFORTABLE FIT, KNITWRIST CUFF AND BREATHABLE BACK



PACKING OF 12* PAIRS

Art.	€	Size
GL722/07	€ 4,72	7
GL722/08	€ 4,72	8
GL722/09	€ 4,72	9
GL722/10	€ 4,72	10

GL762-**SEAMLESS NYLON GLOVE/POLYURETHANE**

PALM COATED WITH POLYURETHANE, LIGHTWEIGHT, ELASTIC, WITH EXCELLENT TACTILE SENSITIVITY, SUGGESTED FOR DELICATE AND PRECISION JOBS, EXCELLENT ABRASION RESISTANCE AND DURABILITY, ERGONOMIC DESIGN FOR A COMFORTABLE FIT, KNITWRIST CUFF AND BREATHABLE BACK



PACKING OF 12* PAIRS

Art.	€	Size
GL762/M	€ 2,87	M
GL762/L	€ 2,87	L
GL762/XL	€ 2,87	XL
GL762/XXL	€ 2,87	XXL

GL515-**SEAMLESS COTTON-POLYESTER GLOVE / LATEX**

PALM COATED WITH LATEX, WRINKLE FINISH FOR EXTRAORDINARY DRY & WET GRIP, ERGONOMIC DESIGN FOR A COMFORTABLE FIT, KNITWRIST CUFF AND BREATHABLE BACK



PACKING OF 12* PAIRS

Art.	€	Size
GL515/08	€ 2,75	8
GL515/09	€ 2,75	9
GL515/10	€ 2,75	10



GL398-

15-GAUGE SEAMLESS NYLON-ELASTANE GLOVE / NITRILE FOAM

PALM COATED WITH NITRILE FOAM WHICH MAKES THE GLOVE SOFT, LIGHT AND BREATHABLE, DOTS ON PALM FOR BETTER GRIP AND WEAR RESISTANCE, ANTI-PILLING, WATER AND OIL REPELLENT, EXCELLENT ABRASION RESISTANCE, TOGETHER WITH HIGH FLEXIBILITY AND DEXTERITY, ERGONOMIC DESIGN FOR A COMFORTABLE FIT, KNITWRIST CUFF AND BREATHABLE BACK



PACKING OF 12* PAIRS

Art.	€	Size
GL398/07	€ 4,89	7
GL398/08	€ 4,89	8
GL398/09	€ 4,89	9
GL398/10	€ 4,89	10

GL503-

SEAMLESS NYLON GLOVE / LATEX

PALM COATED WITH A SPECIAL SOFT LATEX FOAM, WRINKLE FINISH FOR EXTRAORDINARY DRY & WET GRIP, YELLOW FLUO LINER FOR HIGHER VISIBILITY WHEN USED IN HALF-LIGHT OR LOW VISIBILITY CONDITIONS, HIGH WEAR AND TEAR RESISTANCE, EXCEPTIONAL FLEXIBILITY, GOOD TACTILE SENSITIVITY, ERGONOMIC DESIGN FOR A COMFORTABLE FIT, KNITWRIST CUFF AND BREATHABLE BACK



PACKING OF 12* PAIRS

Art.	€	Size
GL503/08	€ 4,72	8
GL503/09	€ 4,72	9
GL503/10	€ 4,72	10

GL386-

13 GAUGE SEAMLESS POLYESTER GLOVE / NITRILE

PALM COATED WITH NITRILE WITH A SLIGHTLY WRINKLE FINISH DUE TO THE PROCESSING OF THE LINER, VERY GOOD GRIP, HIGH FLEXIBILITY AND DEXTERITY, HIGH ABRASION RESISTANCE, ERGONOMIC DESIGN FOR A COMFORTABLE FIT, KNITWRIST CUFF AND BREATHABLE BACK



PACKING OF 12* PAIRS

Art.	€	Size
GL386/08	€ 1,93	8
GL386/09	€ 1,93	9
GL386/10	€ 1,93	10

GL396-

15-GAUGE SEAMLESS NYLON-ELASTANE GLOVE / NITRILE FOAM

PALM COATED WITH NITRILE FOAM WITH NPT™ TECHNOLOGY, FOR OUTSTANDING GRIP AND NON-SLIP PROPERTIES, BOTH IN DRY & WET CONDITIONS, OR IN CONTACT WITH OILY SURFACES AND FOR INCREASED ABRASION RESISTANCE, WITH ANTIBACTERIAL SANITIZED® TREATMENT, CONSIDERABLE FLEXIBILITY AND DEXTERITY, ERGONOMIC DESIGN FOR A COMFORTABLE FIT, KNITWRIST CUFF AND BREATHABLE BACK



PACKING OF 12* PAIRS

Art.	€	Size
GL396/07	€ 6,00	7
GL396/08	€ 6,00	8
GL396/09	€ 6,00	9
GL396/10	€ 6,00	10

GL750-

13-GAUGE SEAMLESS GLOVE WITH DYNEEMA® + LYCRA® / POLYURETHANE

POLYURETHANE PALM COATED, WITH DYNEEMA® FIBER FOR MEDIUM TO HIGH CUT RESISTANCE WHILE ENHANCING WEARER COMFORT AND DEXTERITY, MAXIMUM PROTECTION WHEN PERFORMING PRECISION LONG-LASTING OPERATIONS WHEN ULTRA HIGH RESISTANCE TO CUT IS ESSENTIAL WITHOUT LOSING FACILITY, WITH ANTIBACTERIAL SANITIZED® TREATMENT, EXCELLENT LEVELS OF MECHANICAL RESISTANCE, KNITWRIST CUFF AND BREATHABLE BACK



PACKING OF 12* PAIRS

Art.	€	Size
GL750/08	€ 10,80	8
GL750/09	€ 10,80	9
GL750/10	€ 10,80	10

GL918-

NITRILE GLOVE

CHLORINATED, EXTERNAL NON-SLIP PATTERN PROVIDES GOOD GRIP, EXCELLENT TACTILE SENSITIVITY (EXTREMELY THIN, IS A GOOD COMPROMISE BETWEEN A DISPOSABLE GLOVE AND A CLASSIC INDUSTRIAL NITRILE GLOVE), SUITABLE FOR FOOD CONTACT



PACKING OF 12* PAIRS

Art.	€	Size	Thickness
GL918/07	€ 3,09	7	0,22 mm
GL918/08	€ 3,09	8	0,22 mm
GL918/09	€ 3,09	9	0,22 mm
GL918/10	€ 3,09	10	0,22 mm



GL626-**LATEX GLOVE**

SMOOTH INSIDE, EXTERIOR EMBOSSED TEXTURE ON PALM AND FINGERS FOR INCREASED GRIP



PACKING OF 12* PAIRS

Art.	€	Size	Thickness
GL626/M	€ 2,85	M	0,55 mm
GL626/L	€ 2,85	L	0,55 mm
GL626/XL	€ 2,85	XL	0,55 mm

GL340-**NITRILE GLOVE GREASE MONKEY**

DISPOSABLE, AMBIDEXTROUS, POWDER-FREE, COMPLETELY LATEX-FREE, FISHSCALE GRIP ON PALM AND BACK, HIGH COMFORT, SENSITIVITY AND DEXTERITY, EXTRAORDINARY RESISTANCE TO OILS/GREASES, SUITABLE FOR FOOD CONTACT



50 Pcs

Art.	€	Size	Thickness	AQL
GL340/M	€ 14,20	M	0,15 mm	1,5
GL340/L	€ 14,20	L	0,15 mm	1,5
GL340/XL	€ 14,20	XL	0,15 mm	1,5
GL340/XXL	€ 14,20	XXL	0,15 mm	1,5

GL346-**NITRILE GLOVE**

DISPOSABLE AND AMBIDEXTROUS, POWDER-FREE, CHLORINATED, WITH TEXTURED FINGERTIPS, LIGHTWEIGHT, FLEXIBLE AND TOUCH SENSITIVE, SUITABLE FOR FOOD CONTACT



100 Pcs

Art.	€	Size	Thickness	AQL
GL346/S	€ 10,70	S	0,10 mm	1,5
GL346/M	€ 10,70	M	0,10 mm	1,5
GL346/L	€ 10,70	L	0,10 mm	1,5
GL346/XL	€ 10,70	XL	0,10 mm	1,5

GL343-**NITRILE GLOVE CLEAN MONKEY**

DISPOSABLE AND AMBIDEXTROUS, POWDER-FREE, FISHSCALE GRIP ON PALM AND BACK, HIGH COMFORT, SENSITIVITY AND DEXTERITY, SUITABLE FOR FOOD CONTACT



50 Pcs

Art.	€	Size	Thickness	AQL
GL343/M	€ 26,70	M	0,20 mm	1,5
GL343/L	€ 26,70	L	0,20 mm	1,5
GL343/XL	€ 26,70	XL	0,20 mm	1,5
GL343/XXL	€ 26,70	XXL	0,20 mm	1,5

GL230-**VINYL GLOVE**

DISPOSABLE AND AMBIDEXTROUS, WITH POWDER, EXTERIOR SMOOTH FINISH, HIGH SENSITIVITY AND DEXTERITY, SUITABLE FOR MEDICAL USE, SUITABLE FOR FOOD CONTACT



100 Pcs

Art.	€	Size	Thickness	AQL
GL230/S	€ 7,90	S	0,08 mm	1,5
GL230/M	€ 7,90	M	0,08 mm	1,5
GL230/L	€ 7,90	L	0,08 mm	1,5
GL230/XL	€ 7,90	XL	0,08 mm	1,5

GL320-**NITRILE GLOVE**

DISPOSABLE AND AMBIDEXTROUS, WITHOUT POWDER, CHLORINATED EXTERIOR GRAINED FINISH, EXCELLENT SENSITIVITY AND DEXTERITY, SUITABLE FOR MEDICAL USE, SUITABLE FOR FOOD CONTACT



100 Pcs

Art.	€	Size	Thickness	AQL
GL320/S	€ 13,00	S	0,10 mm	1,5
GL320/M	€ 13,00	M	0,10 mm	1,5
GL320/L	€ 13,00	L	0,10 mm	1,5
GL320/XL	€ 13,00	XL	0,10 mm	1,5



EW210

€ 4,03

POLYCARBONATE EYEGLASS TEMPLE

SINGLE LENS WITH SIDE PROTECTIONS. IT CAN BE WORN ON TOP OF SPECTACLES



EN 166

Optic class 1

EW152

€ 2,75

PLASTIC PANORAMIC GOGGLES

PLASTIC ONE-PIECE LENS, SIDE AERATION HOLES, ELASTIC BAND



EN 166

Optic class 1

EW154

€ 2,94

PLASTIC PANORAMIC GOGGLES

PLASTIC ONE-PIECE LENS, AERATION VALVES, ELASTIC BAND



EN 166

Optic class 1

EW207

€ 6,80

EYEGLASS TEMPLE

TRANSPARENT POLYCARBONATE FRAME, NO-MIST AND ANTI-SCRATCH LENSES, PANORAMIC WRAP-AROUND STRUCTURE, SIDE PROTECTIONS



EN 166

Optic class 1

EW213

€ 6,60

EYEGLASS TEMPLE

POLYCARBONATE FRAME, NO-MIST AND ANTI-SCRATCH LENSES, PANORAMIC WRAP-AROUND STRUCTURE, TEMPLES WITH ADJUSTABLE LENGTH



EN 166

Optic class 1

FP120

€ 7,20

POLYTHENE HELMET

ADJUSTABLE STRAPS WITH 6 FASTENING POINTS, ELECTRIC INSULATION UP TO 440 V, SWEAT BAND



EN 397

Weight 380 g

FP190

€ 36,10

POSITIONING BELT

2 LATERAL ANCHOR RINGS, ADJUSTABLE BUCKLE, PADDED BACK SUPPORT



EN358

Weight 460 g

FP194

€ 30,40

ADJUSTABLE SAFETY LANYARD

"KERNMANTEL" POLYAMIDE SAFETY LANYARD, WITH ADJUSTABLE BUCKLE, ZINC GALVANIZED STEEL CONNECTOR (Ø 18 mm) WITH SAFETY LOCK

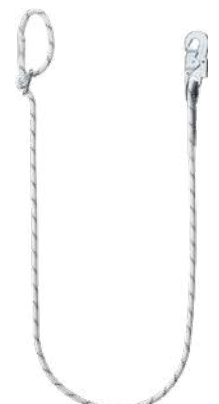

EN 354 & EN 358

Cable diameter Ø 12 mm
Length Max 2 m (connectors included) mm
Weight 545 g



FP166**SELF-CLOSING CONNECTOR**

€ 9,30



EN 362 - Class B Zinc galvanized steel

Opening	18 mm
Static resistance of spring catch	> 25 kN
Weight	180 g

FP144**SAFETY LANYARD WITH ENERGY ABSORBER**

€ 66,70

"KERNMANTEL" SAFETY LANYARD, CONNECTORS NOT INCLUDED



EN 355 Polyamide

Cable diameter	Ø 10,5 mm
Length	Max 2 m (connectors included) mm
Weight	345 g

FP192**BODY HARNESS**

WITH DORSAL AND STERNAL ANCHOR POINTS, ADJUSTABLE BUCKLE FOR LEGS, ADJUSTABLE CHEST CONNECTING STRAP

€ 38,60



EN 361

Weight	690 g
--------	-------

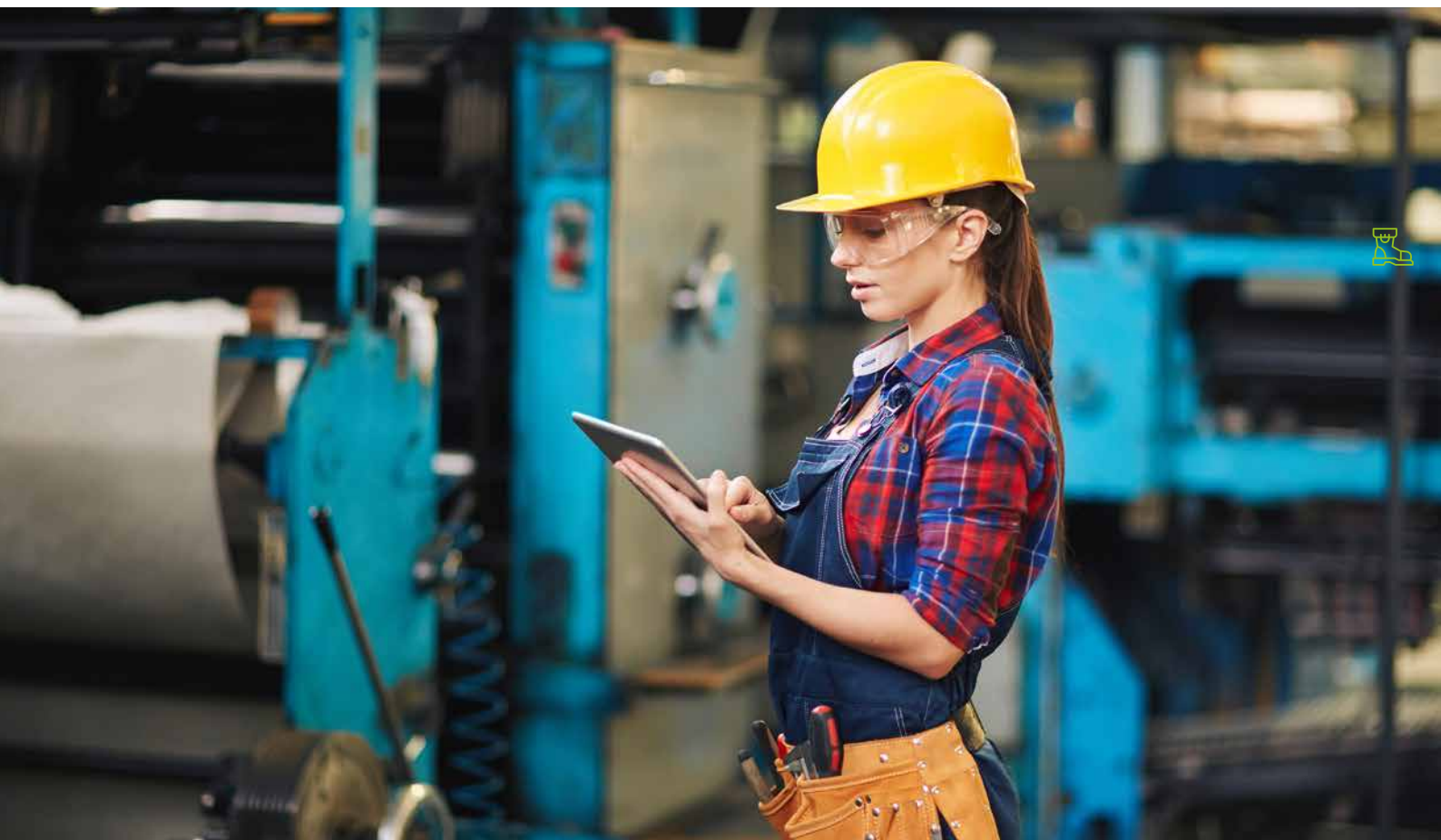

0148/72

€ 29,90

FIRST AID PRODUCTS

CONFORM TO ATTACHMENT 2 FOR FIRM WITH MAX 2 PEOPLES, PACKED IN POLYPROPYLENE CASE WITH SCREWS FOR WALL MOUNT

Content:

- 2 Pair sterile gloves
- 1 Bottle disinfectant 125 ml IODINE TINCTURE at 10% iodine
- 1 Bottle sterile physiological solution 250 ml
- 3 sterile gauze compresses cm 10x20
- 1 sterile gauze compress cm 18x40
- 1 Packet cotton wool
- 1 Latex Tourniquet
- 1 Sterile tweezers
- 1 Pack of 20 assorted adhesive plasters
- 1 Roll adhesive plaster 5m x 2.5 cm
- 1 gauze bandage rolls cm 10
- 1 Pair scissors
- 1 Single-use instant ice pack
- 1 Bag for sanitary waste
- 1 Multilingual first aid instruction booklet



Case size 309 x 209 x 97 mm

0148/73

€ 111,00

FIRST AID PRODUCTS

THAT ARE CONFORM TO ATTACHMENT 1 FOR FIRM WITH MORE THAN 2 PEOPLES, PACKED IN POLYPROPYLENE CASE WITH SCREWS FOR WALL MOUNT

Content:

- 5 Pairs sterile gloves
- 1 Mask with splash guard visor
- 3 Bottles sterile physiological solution 500 ml
- 2 Bottles disinfectant 500 ml IODINE TINCTURE at 10% iodine
- 10 Packets sterile gauze compress cm 20x20
- 2 Packets sterile gauze compress cm 18x40
- 2 Sterile sheets cm. 40x60
- 2 Sterile TWEEZERS
- 1 Packet cotton wool
- 1 Box tubular elastic bandage - medium size
- 2 Packs of 20 assorted plasters
- 2 Rolls adhesive plaster 5 m x 2.5 cm
- 1 Pair scissors
- 3 Latex Tourniquets
- 2 Single-use instant ice packs
- 2 Bags for sanitary waste
- 1 Clinical thermometer CE with case
- 1 Sphygmomanometer with stethoscope
- 1 multilingual first aid instruction booklet



Case size 405 x 300 x 114 mm

0148/64

€ 19,70

FIRST AID PRODUCTS

NYLON BAG FOR VEHICLES AND FIRMS WITH LESS THAN 3 PEOPLE, INCLUDED CONTENTS OF ATTACHMENT 2, WITH HANDLE, SHOULDER STRAP AND ZIPPER.

Content:

- 2 Pair sterile gloves
- 1 Bottle disinfectant 125 ml IODINE TINCTURE at 10% iodine
- 1 Bottle sterile physiological solution 250 ml
- 3 sterile gauze compresses cm 10x20
- 1 sterile gauze compress cm 18x40
- 1 Packet cotton wool
- 1 Latex Tourniquet
- 1 Sterile tweezers
- 1 Pack of 20 assorted adhesive plasters
- 1 Roll adhesive plaster 5m x 2.5 cm
- 1 gauze bandage rolls cm 10
- 1 Pair scissors
- 1 Single-use instant ice pack
- 1 Bag for sanitary waste
- 1 Multilingual first aid instruction booklet



Case size 250 x 180 x 90 mm



HP207

€ 21,50

PROTECTIVE EARMUFF

HEAD BOW WITH SOFT PADDING FOR INCREASED COMFORT, FAST AND STABLE HEIGHT ADJUSTMENT, ADJUSTABLE ABS CUPS WITH SOFT PADDED CUSHIONS, CAN BE USED WITH HELMETS, EYE SHIELDS AND MASKS



EN 352-1

SNR	32
Weight	268 g

HP603

€ 3,75

EARPLUGS WITH BOW

POLYETHYLENE BOW, EXTREMELY SOFT POLYURETHANE PLUGS WHICH LEAN ON THE EAR CANAL WITHOUT PENETRATING INSIDE

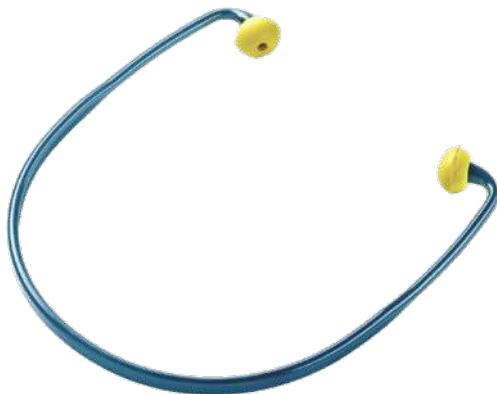

EN 352-2

SNR	20
Weight	11 g

PG707-**DISPOSABLE COVERALL WITH HOOD**

100% POLYPROPYLENE NONWOVEN FABRIC, HYPOALLERGENIC MATERIAL, FIXED HOOD WITH ELASTIC BAND, LATEX FREE, ELASTIC BAND ON CUFF AND ANKLES, LATEX FREE, WITHOUT POCKETS, ZIPPER FASTENER



Art.	€	Category	Weight
PG707/M	€ 2,82	1	40 g/m ²
PG707/L	€ 2,82	1	40 g/m ²
PG707/XL	€ 2,82	1	40 g/m ²
PG707/XXL	€ 2,82	1	40 g/m ²

HP205

€ 9,50

PROTECTIVE EARMUFF

ABS BOW, TURNING IN THREE POSITIONS, CUSHIONS IN SPONGE + PVC, HEIGHT TRIGGER ADJUSTMENT, CAN BE USED WITH HELMETS, EYE SHIELDS AND MASKS



EN 352-1

SNR	4+F286
Weight	145 g

HP601

€ 49,90

DISPOSABLE EARPLUGS IN POLYURETHANE FOAM

ANATOMICAL SHAPE, SMOOTH SURFACE FOR IMPROVED COMFORT AND HYGIENE, 1 PAIR/BAG



200 Pcs EN 352-2

SNR	37
-----	----

PG760-**DISPOSABLE COVERALL WITH HOOD**

POLYPROPYLENE NONWOVEN FABRIC (52%) WITH MICROPOROUS POLYETHYLENE FILM (48%), HYPOALLERGENIC MATERIAL, MICROPOROUS SURFACE, FIXED HOOD WITH ELASTIC, LATEX FREE, ELASTIC BAND ON CUFF, ANKLES AND WAIST, LATEX FREE, FASTENER WITH ZIPPER AND FLAP



Art.	€	Category	Weight
PG760/M	€ 5,80	3	63 g/m ²
PG760/L	€ 5,80	3	63 g/m ²
PG760/XL	€ 5,80	3	63 g/m ²
PG760/XXL	€ 5,80	3	63 g/m ²



RP100

€ 6,80

HYGIENIC MASK
NONWOVEN FABRIC



50 Pcs

RP120

€ 1,20

MASK IN NONWOVEN FABRIC

PROTECTION AGAINST NON-TOXIC SOLID AND LIQUID AEROSOLS IN CONCENTRATIONS UP TO 4X TLV, SEMIRIGID STRUCTURE, SOFT SEAL ON THE NOSE



EN 149: 2001 + A1: 2009

Features FFP1 NR D
Weight 12 g

RP123

€ 1,36

MASK IN NONWOVEN FABRIC

PROTECTION AGAINST NON-TOXIC AND LOW-TO-AVERAGE TOXICITY SOLID AND LIQUID AEROSOLS, IN CONCENTRATION UP TO 12X TLV



EN 149: 2001 + A1: 2009

Features FFP2 NR D
Weight 11 g

RP124

€ 2,09

MASK IN NONWOVEN FABRIC

WITH EXHALATION VALVE, PROTECTION AGAINST NON-TOXIC AND LOW-TO-AVERAGE TOXICITY SOLID AND LIQUID AEROSOLS, IN CONCENTRATION UP TO 12X TLV



EN 149: 2001 + A1: 2009

Features FFP2 NR D
Weight 17 g

RP127

€ 3,79

MASK IN NONWOVEN FABRIC WITH ACTIVE CARBONS

PROTECTION AGAINST NON-TOXIC AND LOW-TO-AVERAGE TOXICITY SOLID AND LIQUID AEROSOLS, IN CONCENTRATION UP TO 12X TLV, EQUIPPED WITH NEW EXHALATION VALVE NEWTEC®, WITH ACTIVE CARBON TO PREVENT INHALATION OF STRONG ODOURS, SOFT SEAL ON THE NOSE



EN 149: 2001 + A1: 2009

Features FFP2 NR D
Weight 22 g

RP133

€ 3,43

FLEXIBLE MASK IN NONWOVEN FABRIC

PROTECTION AGAINST HIGH-TOXICITY POWDERS, INCLUDING WATER BASED AEROSOL IN CONCENTRATIONS UP TO 50X TLV, EQUIPPED WITH NEW EXHALATION VALVE NEWTEC®, SOFT SEAL ON THE NOSE, INDIVIDUALLY PACKAGED



EN 149: 2001 + A1: 2009

Features FFP3 NR D
Weight 20 g

RP126

€ 5,80

MASK IN NONWOVEN FABRIC

PROTECTION AGAINST NON-TOXIC, LOW-TO-AVERAGE TOXICITY AND HIGH-TOXICITY SOLID AND LIQUID AEROSOLS IN CONCENTRATIONS UP TO 50X TLV, EQUIPPED WITH EXHALATION VALVE NEWTEC®, SOFT SEAL PROTECTION ALONG THE INNER EDGE OF THE FACE



EN 149: 2001 + A1: 2009

Features FFP3 NR D
Weight 22 g



FW010-**PROTECTIVE LOW SHOE**

IN SPLIT LEATHER, REFLECTIVE MATERIAL INSERTS, BREATHABLE INTERNAL LINING, REMOVABLE ANATOMIC INSOLE, DUAL DENSITY POLYURETHANE OUTSOLE, STEEL TOE CAP, STEEL LAYER, CLOSING WITH BICOLOURED LACES



 EN ISO 20345: 2011

Art.	€	Features	Size
FW010/38	€ 59,70	S3 SRC	38
FW010/39	€ 59,70	S3 SRC	39
FW010/40	€ 59,70	S3 SRC	40
FW010/41	€ 59,70	S3 SRC	41
FW010/42	€ 59,70	S3 SRC	42
FW010/43	€ 59,70	S3 SRC	43
FW010/44	€ 59,70	S3 SRC	44
FW010/45	€ 59,70	S3 SRC	45
FW010/46	€ 59,70	S3 SRC	46
FW010/47	€ 59,70	S3 SRC	47

FW505-**PROTECTIVE HIGH SHOE**

IN COW GRAIN LEATHER, BREATHABLE INTERNAL LINING, REMOVABLE, PREFORMED INSOLE, QUICK TAKE-OFF DEVICE, DUAL DENSITY POLYURETHANE OUTSOLE, STEEL TOE-CAP, STEEL LAYER, CLOSURE WITH BICOLOURED LACES



 EN ISO 20345: 2011

Art.	€	Features	Size
FW505/38	€ 49,90	S3 SRC	38
FW505/39	€ 49,90	S3 SRC	39
FW505/40	€ 49,90	S3 SRC	40
FW505/41	€ 49,90	S3 SRC	41
FW505/42	€ 49,90	S3 SRC	42
FW505/43	€ 49,90	S3 SRC	43
FW505/44	€ 49,90	S3 SRC	44
FW505/45	€ 49,90	S3 SRC	45
FW505/46	€ 49,90	S3 SRC	46
FW505/47	€ 49,90	S3 SRC	47

FW031-**PROTECTIVE LOW SHOE**

IN SUEDE SPLIT LEATHER, UPPER IN SUEDE SPLIT LEATHER, HEEL COVERED WITH ABRASION RESISTANT INSERT, HYDROPHILIC, BREATHABLE INTERNAL LINING, PREFORMED EVA REMOVABLE INSOLE, RUBBER SOLE, COMPOSITE TOE-CAP, TEXTILE LAYER, CLOSURE WITH ORANGE LACES (GREY SPARE LACES INCLUDED)



 EN ISO 20345: 2011

Art.	€	Features	Size
FW031/36	€ 86,70	S1P HRO SRC	36
FW031/37	€ 86,70	S1P HRO SRC	37
FW031/38	€ 86,70	S1P HRO SRC	38
FW031/39	€ 86,70	S1P HRO SRC	39
FW031/40	€ 86,70	S1P HRO SRC	40
FW031/41	€ 86,70	S1P HRO SRC	41
FW031/42	€ 86,70	S1P HRO SRC	42
FW031/43	€ 86,70	S1P HRO SRC	43
FW031/44	€ 86,70	S1P HRO SRC	44
FW031/45	€ 86,70	S1P HRO SRC	45
FW031/46	€ 86,70	S1P HRO SRC	46
FW031/47	€ 86,70	S1P HRO SRC	47
FW031/48	€ 86,70	S1P HRO SRC	48

FW035-**PROTECTIVE LOW SHOE**

IN SUEDE SPLIT LEATHER, HEEL COVERED WITH ABRASION RESISTANT INSERT, UPPER SIDE MESH INSERTS, HYDROPHILIC, BREATHABLE INTERNAL LINING, PREFORMED EVA REMOVABLE INSOLE, RUBBER SOLE, COMPOSITE TOE-CAP, TEXTILE LAYER, CLOSING WITH YELLOW LACES



 EN ISO 20345: 2011

Art.	€	Features	Size
FW035/36	€ 86,70	S1P HRO SRC	36
FW035/37	€ 86,70	S1P HRO SRC	37
FW035/38	€ 86,70	S1P HRO SRC	38
FW035/39	€ 86,70	S1P HRO SRC	39
FW035/40	€ 86,70	S1P HRO SRC	40
FW035/41	€ 86,70	S1P HRO SRC	41
FW035/42	€ 86,70	S1P HRO SRC	42
FW035/43	€ 86,70	S1P HRO SRC	43
FW035/44	€ 86,70	S1P HRO SRC	44
FW035/45	€ 86,70	S1P HRO SRC	45
FW035/46	€ 86,70	S1P HRO SRC	46
FW035/47	€ 86,70	S1P HRO SRC	47
FW035/48	€ 86,70	S1P HRO SRC	48



FW008-

PROTECTIVE LOW SHOE

IN SUEDE SPLIT LEATHER, PERFORATED UPPER, BREATHABLE INTERNAL LINING, REMOVABLE ANATOMIC INSOLE, DUAL DENSITY POLYURETHANE OUTSOLE, STEEL TOE-CAP, STEEL LAYER, CLOSING WITH BICOLOURED LACES



EN ISO 20345:2011

Art.	€	Features	Size
FW008/35	€ 43,30	S1P SRC	35
FW008/36	€ 43,30	S1P SRC	36
FW008/37	€ 43,30	S1P SRC	37
FW008/38	€ 43,30	S1P SRC	38
FW008/39	€ 43,30	S1P SRC	39
FW008/40	€ 43,30	S1P SRC	40
FW008/41	€ 43,30	S1P SRC	41
FW008/42	€ 43,30	S1P SRC	42
FW008/43	€ 43,30	S1P SRC	43
FW008/44	€ 43,30	S1P SRC	44
FW008/45	€ 43,30	S1P SRC	45
FW008/46	€ 43,30	S1P SRC	46
FW008/47	€ 43,30	S1P SRC	47

SP01-

PROFESSIONAL BOOT MADE OF NITRILE RUBBER

WITH RESISTANCE TO ALL INDUSTRIAL OR BIOLOGICAL CHEMICAL PRODUCTS SUCH AS: OIL, MINERAL OILS, VEGETAL OILS ETC. IT HAS A GOOD RESISTANCE BOTH TO HIGH AND LOW TEMPERATURES (-30° G.C), EN20347:2011



EN ISO 20347:2012 **SRA**



Art.	€	Size
SP01/39	€ 25,30	39
SP01/40	€ 25,30	40
SP01/41	€ 25,30	41
SP01/42	€ 25,30	42
SP01/43	€ 25,30	43
SP01/44	€ 25,30	44
SP01/45	€ 25,30	45
SP01/46	€ 25,30	46
SP01/47	€ 25,30	47

SP02-

SAFETY BOOT MADE OF NITRILE RUBBER

WITH RESISTANCE TO ALL INDUSTRIAL OR BIOLOGICAL CHEMICAL PRODUCTS SUCH AS: OIL, MINERAL OILS, VEGETAL OILS ETC. IT HAS A GOOD RESISTANCE BOTH TO HIGH AND LOW TEMPERATURES (-30° G.C). IT ALSO HAS A STEEL TOE-CAP AND SOLE. REINFORCED MODEL FOR PROTECTION OF THE TIBIA, MALLEOLUS AND HEEL. SHOCK-ABSORBING SOLE MADE OF ANTI-STATIC MATERIALS.



EN ISO 20345:2011 **SRC**



Art.	€	Size
SP02/39	€ 33,60	39
SP02/40	€ 33,60	40
SP02/41	€ 33,60	41
SP02/42	€ 33,60	42
SP02/43	€ 33,60	43
SP02/44	€ 33,60	44
SP02/45	€ 33,60	45
SP02/46	€ 33,60	46
SP02/47	€ 33,60	47

SP03-

SAFETY BOOT MADE OF PVC

WITH STEEL TOE-CAP AND SOLE. REINFORCED MODEL FOR PROTECTION OF THE TIBIA, MALLEOLUS AND HEEL. SHOCK-ABSORBING SOLE MADE OF ANTI-STATIC MATERIALS



EN ISO 20345:2011 **SRC**



Art.	€	Size
SP03/39	€ 27,90	39
SP03/40	€ 27,90	40
SP03/41	€ 27,90	41
SP03/42	€ 27,90	42
SP03/43	€ 27,90	43
SP03/44	€ 27,90	44
SP03/45	€ 27,90	45
SP03/46	€ 27,90	46
SP03/47	€ 27,90	47

SP04-

WORKING BOOT MADE OF PVC

WITH NO-MOULD WASHABLE SOCK, INNER NAILS TO HOLD OVERALLS AND TROUSERS AND INTEGRATED PULL-OFF SPUR



EN ISO 20347:2012 **SRA**



Art.	€	Size
SP04/39	€ 21,40	39
SP04/40	€ 21,40	40
SP04/41	€ 21,40	41
SP04/42	€ 21,40	42
SP04/43	€ 21,40	43
SP04/44	€ 21,40	44
SP04/45	€ 21,40	45
SP04/46	€ 21,40	46
SP04/47	€ 21,40	47

SP05-

WINTER BOOT

WATERPROOF, MADE OF A COMPOUND OF PVC AND SPECIAL ADDITIVE FOR COLD RESISTANCE WITHOUT CADMIUM, LEAD AND BARIUM, WITH REINFORCED UNDERSOLE AND TWO LAYER 4 mm INSOLE



Art.	€	Size
SP05/36	€ 35,60	36
SP05/37	€ 35,60	37
SP05/38	€ 35,60	38
SP05/39	€ 35,60	39
SP05/40	€ 35,60	40
SP05/41	€ 35,60	41
SP05/42	€ 35,60	42
SP05/44	€ 35,60	44
SP05/45	€ 35,60	45
SP05/46	€ 35,60	46
SP05/47	€ 35,60	47
SP05/48	€ 35,60	48

SP06-

CANADIAN BOOT MADE OF TEFAPRENE

WITH ANTI-SLIPPING OUTSOLE, POLYESTER FUR LINING AND ANTI-RUST HOOKS



Art.	€	Size
SP06/39	€ 47,20	39
SP06/40	€ 47,20	40
SP06/42	€ 47,20	42
SP06/43	€ 47,20	43
SP06/45	€ 47,20	45
SP06/46	€ 47,20	46
SP06/47	€ 47,20	47

SP07-

CANADIAN BOOT MADE OF TEFAPRENE

FLEXIBLE AND RESISTANT EVEN AT LOW TEMPERATURE, WITH ANTI-SLIPPING OUTSOLE, POLYESTER FUR LINING AND ANTI-RUST HOOKS





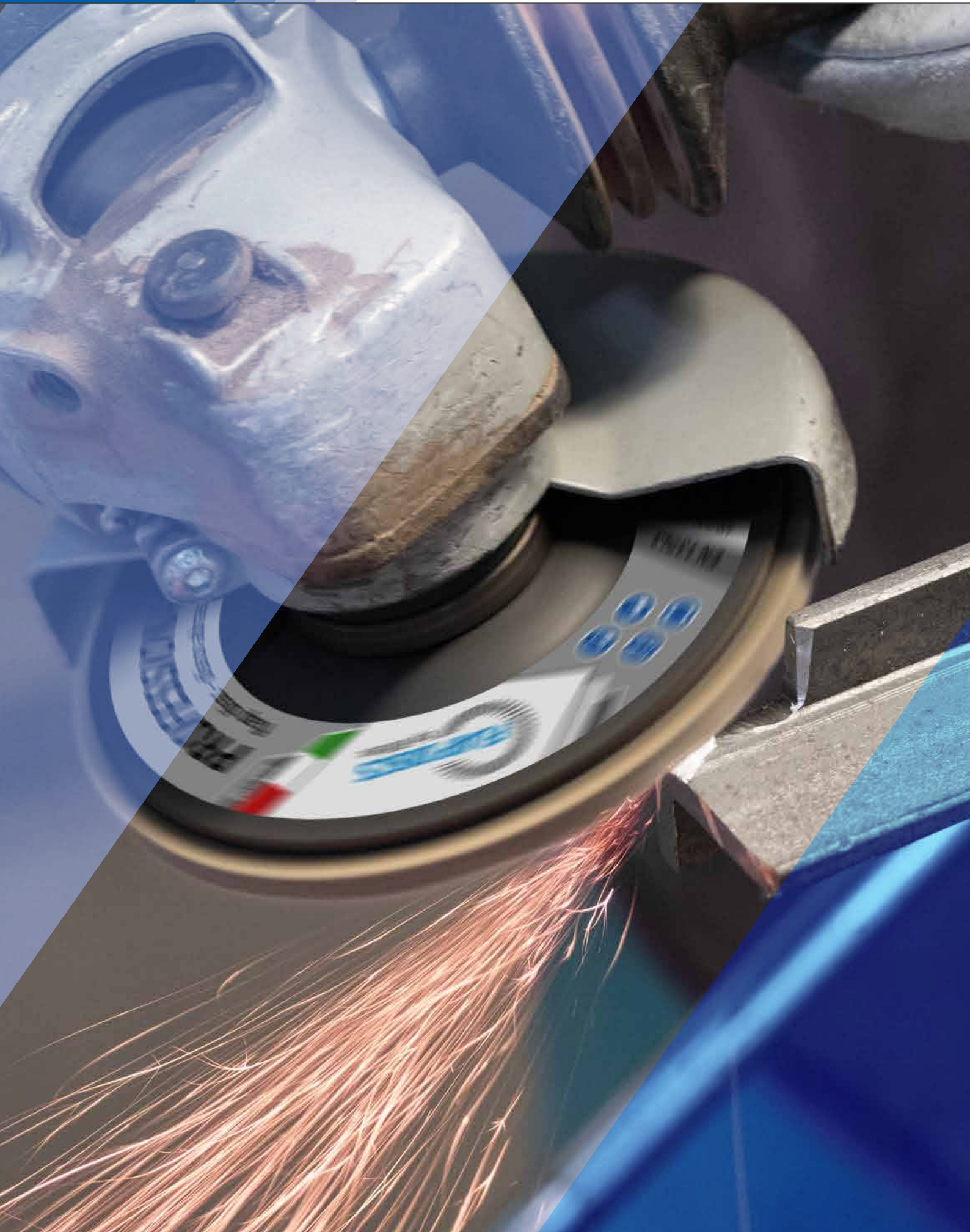

Art.	€	Size
SP07/39	€ 49,40	39
SP07/40	€ 49,40	40
SP07/41	€ 49,40	41
SP07/42	€ 49,40	42
SP07/43	€ 49,40	43
SP07/44	€ 49,40	44
SP07/45	€ 49,40	45
SP07/46	€ 49,40	46
SP07/47	€ 49,40	47







FLAP DISCS

- pag.514*  — Smartflex
- pag.518*  — Grindflex
- pag.522*  — Performance
- pag.526*  — Professional
- pag.530*  — Specialties





CUTTING WHEELS

- pag.533*  — Cutting & abrasive wheels
- pag.536*  — Grinding wheels
- pag.539*  — Diamond blades



TUNGSTEN CARBIDE ROTARY BURRS

- pag.541*  — Diamond cut burrs
- pag.541*  — Single cut burrs
- pag.541*  — Burrs for aluminium



ABRASIVE WHEELS

- pag.547*  — Fast-lock
- pag.549*  — Wheels with shaft
- pag.550*  — Wheels with hole
- pag.551*  — Wheels for satin finishers



WIRE BRUSHES

- pag.554*  — Brushes with bore
- pag.556*  — Brushes with shaft







CLEANING AND POLISHING

- pag.558*  — Abrasive Nylon
- pag.559*  — Non woven
- pag.560*  — Surface Conditioning
- pag.562*  — Felt
- pag.564*  — Cotton and Sisal



ABRASIVE BELTS

- pag.567*  — Vulcanized discs
- pag.568*  — Velcro discs
- pag.571*  — Rolls and sheets
- pag.575*  — Belts



Riflex, specific experience

MADE IN ITALY

Since 1982, Riflex has stood out on the international stage thanks to its specific MADE IN ITALY experience in the production of flap discs made of corundum, zirconium and ceramic zirconium with supports made from both nylon and fibreglass, and in the manufacture of automatic systems for their production, testing and packaging.



Know-how and quality

Riflex oversees the entire production chain thanks to relationships spanning decades with key suppliers of raw materials (abrasive backing plates, supports and glue). More than thirty years of experience has allowed the company to develop its own recipes and quality protocols which are among the highest levels worldwide.





FLAP DISCS FERVI BY RIFLEX



SMARTFLEX VALUE FOR MONEY

The best price with professional performances. For removal and finishing operations.

GRINDFLEX MULTI PURPOSE

The "best seller", suitable for massive removals and finishing on most types of ferrous and non-ferrous metal surfaces.



PERFORMANCE HIGH PERFORMANCE

Wide range of professional flap discs based on aluminum oxide or zirconia, available with cotton or polycotton cloth.

PROFESSIONAL PROFESSIONAL TOP LINE

Professional long-life discs with high removal speeds for the most demanding users, powered by Norton™ abrasive cloth.

SPECIALTY FOR SPECIAL WORKING

Range of discs for professional working on stainless steel, non-ferrous metals (aluminum, copper, etc.).

DISC TYPE

CLASSIC

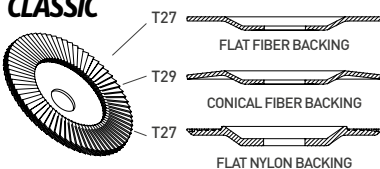

BIGGER

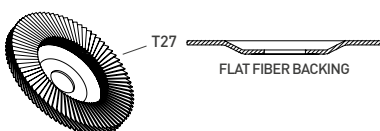

DUAL FLAP

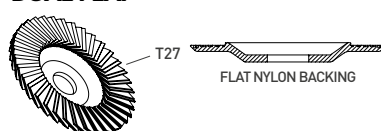

TIGER

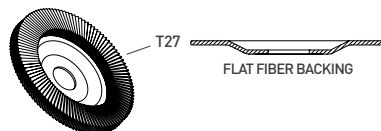

REAL FLAT

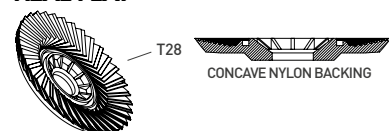

RAPTOR

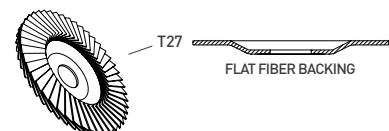



VALUE FOR MONEY

The best price with professional performances.
For removal and finishing operations.

For common uses and low productions - Designed for hobbyists, building and small artisans (individual companies), who do not want to give up performance. Ideal for removing welding beads, sheet metal deburring and finishing.

RECOMMENDED SPEED

Ø	RPM
115	5000/7500
125	4800/7300
180	3250/4900

DF2100-Z

CAT 42

SMARTFLEX FLAP DISC CLASSIC

Backings: Fiberglass Cloth: Zirconia SILVER Flat Single flap

Art.	€	Overall sizes	Grit	rpm max
DF2100.112	€ 1,55	115 x 22 mm	40	13300
DF2100.114	€ 1,55	115 x 22 mm	60	13300
DF2100.115	€ 1,55	115 x 22 mm	80	13300
DF2100.117	€ 1,55	115 x 22 mm	120	13300
DF2100.122	€ 1,89	125 x 22 mm	40	12250
DF2100.124	€ 1,89	125 x 22 mm	60	12250
DF2100.125	€ 1,89	125 x 22 mm	80	12250
DF2100.127	€ 1,89	125 x 22 mm	120	12250



DF2150-Z

CAT 42

SMARTFLEX FLAP DISC CLASSIC

Backings: Fiberglass Cloth: Zirconia SILVER Conical Single flap

Art.	€	Overall sizes	Grit	rpm max
DF2150.112	€ 1,55	115 x 22 mm	40	13300
DF2150.114	€ 1,55	115 x 22 mm	60	13300
DF2150.115	€ 1,55	115 x 22 mm	80	13300
DF2150.117	€ 1,55	115 x 22 mm	120	13300
DF2150.122	€ 1,89	125 x 22 mm	40	12250
DF2150.124	€ 1,89	125 x 22 mm	60	12250
DF2150.125	€ 1,89	125 x 22 mm	80	12250
DF2150.127	€ 1,89	125 x 22 mm	120	12250





DN2100-Z

CAT 42

SMARTFLEX FLAP DISC CLASSIC

Backing: Nylon Cloth: Zirconia SILVER  Flat  Single flap

Art.	€	Overall sizes	Grit	rpm max
DN2100.112	€ 1,55	115 x 22 mm	40	13300
DN2100.114	€ 1,55	115 x 22 mm	60	13300
DN2100.115	€ 1,55	115 x 22 mm	80	13300
DN2100.117	€ 1,55	115 x 22 mm	120	13300
DN2100.122	€ 1,89	125 x 22 mm	40	12250
DN2100.124	€ 1,89	125 x 22 mm	60	12250
DN2100.125	€ 1,89	125 x 22 mm	80	12250
DN2100.127	€ 1,89	125 x 22 mm	120	12250

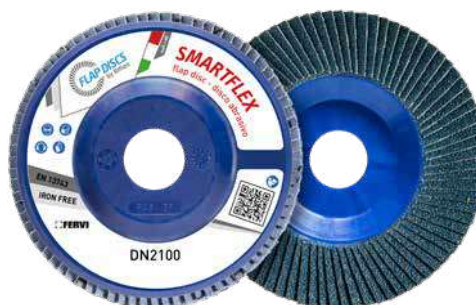

DN2300-Z

CAT 42

SMARTFLEX FLAP DISC DUAL FLAP

Backing: Nylon Cloth: Zirconia SILVER  Flat  Double flap

Art.	€	Overall sizes	Grit	rpm max
DN2300.112	€ 1,55	115 x 22 mm	40	13300
DN2300.114	€ 1,55	115 x 22 mm	60	13300
DN2300.115	€ 1,55	115 x 22 mm	80	13300
DN2300.117	€ 1,55	115 x 22 mm	120	13300
DN2300.122	€ 1,89	125 x 22 mm	40	12250
DN2300.124	€ 1,89	125 x 22 mm	60	12250
DN2300.125	€ 1,89	125 x 22 mm	80	12250
DN2300.127	€ 1,89	125 x 22 mm	120	12250

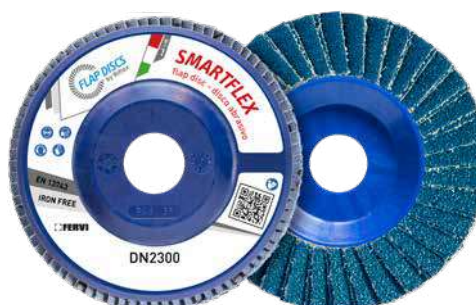

DF2100-A

CAT 42

SMARTFLEX FLAP DISC CLASSIC

Backing: Fiberglass Cloth: Aluminium oxide SILVER
 Flat Single flap

Art.	€	Overall sizes	Grit	rpm max
DF2100.212	€ 1,37	115 x 22 mm	40	13300
DF2100.214	€ 1,37	115 x 22 mm	60	13300
DF2100.215	€ 1,37	115 x 22 mm	80	13300
DF2100.217	€ 1,37	115 x 22 mm	120	13300
DF2100.222	€ 1,75	125 x 22 mm	40	12250
DF2100.224	€ 1,75	125 x 22 mm	60	12250
DF2100.225	€ 1,75	125 x 22 mm	80	12250
DF2100.227	€ 1,75	125 x 22 mm	120	12250



DF2150-A

CAT 42

SMARTFLEX FLAP DISC CLASSIC

Backing: Fiberglass Cloth: Aluminium oxide SILVER
 Conical Single flap

Art.	€	Overall sizes	Grit	rpm max
DF2150.212	€ 1,37	115 x 22 mm	40	13300
DF2150.214	€ 1,37	115 x 22 mm	60	13300
DF2150.215	€ 1,37	115 x 22 mm	80	13300
DF2150.217	€ 1,37	115 x 22 mm	120	13300
DF2150.222	€ 1,75	125 x 22 mm	40	12250
DF2150.224	€ 1,75	125 x 22 mm	60	12250
DF2150.225	€ 1,75	125 x 22 mm	80	12250
DF2150.227	€ 1,75	125 x 22 mm	120	12250



DN2100-A

CAT 42

SMARTFLEX FLAP DISC CLASSIC

Backing: Nylon Cloth: Aluminium oxide SILVER
 Flat Single flap

Art.	€	Overall sizes	Grit	rpm max
DN2100.212	€ 1,37	115 x 22 mm	40	13300
DN2100.214	€ 1,37	115 x 22 mm	60	13300
DN2100.215	€ 1,37	115 x 22 mm	80	13300
DN2100.217	€ 1,37	115 x 22 mm	120	13300
DN2100.222	€ 1,75	125 x 22 mm	40	12250
DN2100.224	€ 1,75	125 x 22 mm	60	12250
DN2100.225	€ 1,75	125 x 22 mm	80	12250
DN2100.227	€ 1,75	125 x 22 mm	120	12250







MULTI PURPOSE

The “best seller”, suitable for massive removals and finishing on most types of ferrous and non-ferrous metal surfaces.

For specific uses, mass productions and finishing - Designed for artisans, large and medium industries. Ideal for the removal of weld seams and processes where long life of the disk is required, as well as sheet metal deburring.

RECOMMENDED SPEED

Ø	RPM
115	5000/7500
125	4800/7300
180	3250/4900

DF4100-Z

GRINDFLEX FLAP DISC CLASSIC

Backing: Fiberglass Cloth: Zirconia GOLD Flat Single Flap

Art.	€	Dimensions	Grit	rpm max
DF4100.112	€ 1,72	115 x 22 mm	40	13300
DF4100.114	€ 1,72	115 x 22 mm	60	13300
DF4100.115	€ 1,72	115 x 22 mm	80	13300
DF4100.117	€ 1,72	115 x 22 mm	120	13300
DF4100.122	€ 2,06	125 x 22 mm	40	12250
DF4100.124	€ 2,06	125 x 22 mm	60	12250
DF4100.125	€ 2,06	125 x 22 mm	80	12250
DF4100.127	€ 2,06	125 x 22 mm	120	12250
DF4100.182	€ 3,43	180 x 22 mm	40	8500
DF4100.184	€ 3,43	180 x 22 mm	60	8500
DF4100.185	€ 3,43	180 x 22 mm	80	8500
DF4100.187	€ 3,43	180 x 22 mm	120	8500



DF4150-Z

GRINDFLEX FLAP DISC CLASSIC

Backing: Fiberglass Cloth: Zirconia GOLD Conical Single Flap

Art.	€	Dimensions	Grit	rpm max
DF4150.112	€ 1,72	115 x 22 mm	40	13300
DF4150.114	€ 1,72	115 x 22 mm	60	13300
DF4150.115	€ 1,72	115 x 22 mm	80	13300
DF4150.117	€ 1,72	115 x 22 mm	120	13300
DF4150.122	€ 2,06	125 x 22 mm	40	12250
DF4150.124	€ 2,06	125 x 22 mm	60	12250
DF4150.125	€ 2,06	125 x 22 mm	80	12250
DF4150.127	€ 2,06	125 x 22 mm	120	12250
DF4150.182	€ 3,43	180 x 22 mm	40	8500
DF4150.184	€ 3,43	180 x 22 mm	60	8500
DF4150.185	€ 3,43	180 x 22 mm	80	8500
DF4150.187	€ 3,43	180 x 22 mm	120	8500



DN4100-Z

*CAT 42

GRINDFLEX FLAP DISC CLASSIC

Backings: Nylon Cloth: Zirconia GOLD Flat Single Flap

Art.	€	Dimensions	Grit	rpm max
DN4100.112	€ 1,72	115 x 22 mm	40	13300
DN4100.114	€ 1,72	115 x 22 mm	60	10500
DN4100.115	€ 1,72	115 x 22 mm	80	13300
DN4100.122	€ 2,15	125 x 22 mm	40	12250
DN4100.124	€ 2,15	125 x 22 mm	60	12250



DN4300-Z

GRINDFLEX FLAP DISC DUAL FLAP

Backings: Nylon Cloth: Zirconia GOLD Flat Double Flap

Art.	€	Dimensions	Grit	rpm max
DN4300.112	€ 1,72	115 x 22 mm	40	13300
DN4300.114	€ 1,72	115 x 22 mm	60	13300
DN4300.115	€ 1,72	115 x 22 mm	80	13300
DN4300.117	€ 1,72	115 x 22 mm	120	13300



DN4550-Z

GRINDFLEX FLAP DISC REAL FLAT

THANKS TO A SPECIAL CONVEX SHAPE BACKING, THIS FLAP DISCS TYPE ARE PERFECTLY FLAT DISCS WITH LARGE FLAPS AND CONSTANT DENSITY AND HARDNESS BOTH AT THE CENTRE AND ON THE PERIPHERAL DIAMETER OF THE DISC.

Backings: Nylon Cloth: Zirconia GOLD Concave Double Flap

Art.	€	Dimensions	Grit	rpm max
DN4550.112	€ 2,40	115 x 22 mm	40	13300
DN4550.114	€ 2,40	115 x 22 mm	60	13300



DF4600-Z

GRINDFLEX FLAP DISC BIGGER

GRIND EVEN LONGER, EVEN FASTER, AND EVEN BETTER FINISHING WITH BIGGER DISC. THE NEW STRUCTURE PROVIDES BETTER BENEFITS COMPARED TO CONVENTIONAL FLAP OR GRINDING DISCS: 50% MORE ABRASION CAPACITY, SAVING A GREAT DEAL OF WORKING TIME, 2X LONGER SERVICE LIFE, EXCELLENT VALUE FOR MONEY, COOLER GRINDING, COSTS AND WORKING TIME REDUCTION



Backings: Fiberglass Cloth: Zirconia GOLD

Flat Single Flap Reinforced

Art.	€	Dimensions	Grit	rpm max
DF4600.112	€ 2,15	115 x 22 mm	40	13300
DF4600.114	€ 2,15	115 x 22 mm	60	13300
DF4600.115	€ 2,15	115 x 22 mm	80	13300
DF4600.117	€ 2,15	115 x 22 mm	120	13300
DF4600.122	€ 2,40	125 x 22 mm	40	12250
DF4600.124	€ 2,40	125 x 22 mm	60	12250
DF4600.182	€ 4,29	180 x 22 mm	40	8500
DF4600.184	€ 4,29	180 x 22 mm	60	8500



DF4100-A

GRINDFLEX FLAP DISC CLASSIC

Backing: Fiberglass Cloth: Aluminium oxide GOLD

Flat Single Fla

Art.	€	Dimensions	Grit	rpm max
DF4100.212	€ 1,55	115 x 22 mm	40	13300
DF4100.214	€ 1,55	115 x 22 mm	60	13300
DF4100.215	€ 1,55	115 x 22 mm	80	13300
DF4100.217	€ 1,55	115 x 22 mm	120	13300
DF4100.222	€ 2,06	125 x 22 mm	40	12250
DF4100.224	€ 2,06	125 x 22 mm	60	12250



DF4150-A

GRINDFLEX FLAP DISC CLASSIC

Backing: Fiberglass Cloth: Aluminium oxide GOLD

Conical Single Flap

Art.	€	Dimensions	Grit	rpm max
DF4150.212	€ 1,55	115 x 22 mm	40	13300
DF4150.214	€ 1,55	115 x 22 mm	60	13300
DF4150.215	€ 1,55	115 x 22 mm	80	13300
DF4150.217	€ 1,55	115 x 22 mm	120	13300
DF4150.222	€ 2,06	125 x 22 mm	40	12250
DF4150.224	€ 2,06	125 x 22 mm	60	12250



DN4100-A

GRINDFLEX FLAP DISC CLASSIC

Backing: Nylon Cloth: Aluminium oxide GOLD Flat Single Flap

Art.	€	Dimensions	Grit	rpm max
DN4100.212	€ 1,63	115 x 22 mm	40	13300
DN4100.214	€ 1,63	115 x 22 mm	60	13300



DN4300-A

GRINDFLEX FLAP DISC DUAL FLAP

Backing: Nylon Cloth: Aluminium oxide GOLD Flat Double Flap

Art.	€	Dimensions	Grit	rpm max
DN4300.212	€ 1,55	115 x 22 mm	40	13300
DN4300.214	€ 1,55	115 x 22 mm	60	13300
DN4300.215	€ 1,55	115 x 22 mm	80	13300
DN4300.217	€ 1,55	115 x 22 mm	120	13300





PERFORMANCE

HIGH PERFORMANCE

Wide range of professional flap discs based on aluminum oxide or zirconia, available with cotton or polycotton cloth.

For mass productions and where high removal capacity is required - Designed for medium and large companies. Ideal for demanding users and heavy-duty applications where long disk life is required.

RECOMMENDED SPEED

Ø	RPM
115	5000/7500
125	4800/7300
180	3250/4900

DF6100-Z

PERFORMANCE FLAP DISC CLASSIC

Backing: Fiberglass Cloth: Zirconia DIAMOND
 Flat Single Flap

Art.	€	Dimensions	Grit	rpm max
DF6100.112	€ 1,89	115 x 22 mm	40	13300
DF6100.114	€ 1,89	115 x 22 mm	60	13300
DF6100.115	€ 1,89	115 x 22 mm	80	13300
DF6100.117	€ 1,89	115 x 22 mm	120	13300
DF6100.122	€ 2,32	125 x 22 mm	40	12250
DF6100.124	€ 2,32	125 x 22 mm	60	12250
DF6100.125	€ 2,32	125 x 22 mm	80	12250
DF6100.182	€ 3,86	180 x 22 mm	40	8500
DF6100.184	€ 3,86	180 x 22 mm	60	8500
DF6100.185	€ 3,86	180 x 22 mm	80	8500



DF6150-Z

PERFORMANCE FLAP DISC CLASSIC

Backing: Fiberglass Cloth: Zirconia DIAMOND
 Conical Single Flap

Art.	€	Dimensions	Grit	rpm max
DF6150.112	€ 1,89	115 x 22 mm	40	13300
DF6150.114	€ 1,89	115 x 22 mm	60	13300
DF6150.115	€ 1,89	115 x 22 mm	80	13300
DF6150.117	€ 1,89	115 x 22 mm	120	13300
DF6150.122	€ 2,32	125 x 22 mm	40	12250
DF6150.124	€ 2,32	125 x 22 mm	60	12250
DF6150.125	€ 2,32	125 x 22 mm	80	12250
DF6150.182	€ 3,86	180 x 22 mm	40	8500
DF6150.184	€ 3,86	180 x 22 mm	60	8500
DF6150.185	€ 3,86	180 x 22 mm	80	8500



DN6100-Z

PERFORMANCE FLAP DISC CLASSIC

Backing: Nylon Cloth: Zirconia DIAMOND Flat Single Flap

Art.	€	Dimensions	Grit	rpm max
DN6100.112	€ 1,89	115 x 22 mm	40	13300
DN6100.114	€ 1,89	115 x 22 mm	60	13300
DN6100.115	€ 1,89	115 x 22 mm	80	13300
DN6100.117	€ 1,89	115 x 22 mm	120	13300
DN6100.122	€ 2,32	125 x 22 mm	40	12250
DN6100.124	€ 2,32	125 x 22 mm	60	12250
DN6100.125	€ 2,32	125 x 22 mm	80	12250
DN6100.182	€ 3,86	180 x 22 mm	40	8500
DN6100.184	€ 3,86	180 x 22 mm	60	8500
DN6100.185	€ 3,86	180 x 22 mm	80	8500



DN6300-Z

PERFORMANCE FLAP DISC DUAL FLAP

Backing: Nylon Cloth: Zirconia DIAMOND Flat Double Flap

Art.	€	Dimensions	Grit	rpm max
DN6300.112	€ 1,89	115 x 22 mm	40	13300
DN6300.114	€ 1,89	115 x 22 mm	60	13300
DN6300.115	€ 1,89	115 x 22 mm	80	13300
DN6300.117	€ 1,89	115 x 22 mm	120	13300
DN6300.122	€ 2,32	125 x 22 mm	40	12250
DN6300.124	€ 2,32	125 x 22 mm	60	12250
DN6300.125	€ 2,32	125 x 22 mm	80	12250
DN6300.182	€ 3,86	180 x 22 mm	40	8500
DN6300.184	€ 3,86	180 x 22 mm	60	8500
DN6300.185	€ 3,86	180 x 22 mm	80	8500

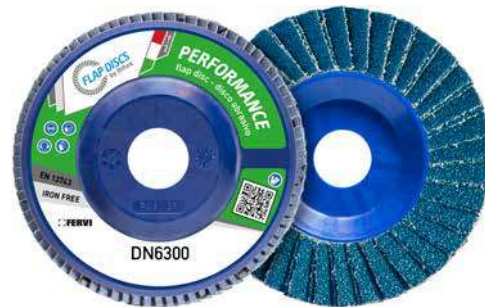

DN6550-Z

PERFORMANCE FLAP DISC REAL FLAT

THANKS TO A SPECIAL CONVEX SHAPE BACKING, THIS FLAP DISCS TYPE ARE PERFECTLY FLAT DISCS WITH LARGE FLAPS AND CONSTANT DENSITY AND HARDNESS BOTH AT THE CENTRE AND ON THE PERIPHERAL DIAMETER OF THE DISC.

Backing: Nylon Cloth: Zirconia DIAMOND Concave Double Flap

Art.	€	Dimensions	Grit	rpm max
DN6550.112	€ 2,58	115 x 22 mm	40	13300
DN6550.114	€ 2,58	115 x 22 mm	60	13300
DN6550.115	€ 2,58	115 x 22 mm	80	13300
DN6550.117	€ 2,58	115 x 22 mm	120	13300



DF6600-Z

PERFORMANCE FLAP DISC BIGGER

GRIND EVEN LONGER, EVEN FASTER, AND EVEN BETTER FINISHING WITH BIGGER DISC. THE NEW STRUCTURE PROVIDES BETTER BENEFITS COMPARED TO CONVENTIONAL FLAP OR GRINDING DISCS: 50% MORE ABRASION CAPACITY, SAVING A GREAT DEAL OF WORKING TIME, 2X LONGER SERVICE LIFE, EXCELLENT VALUE FOR MONEY, COOLER GRINDING, COSTS AND WORKING TIME REDUCTION

Backing: Fiberglass Cloth: Zirconia DIAMOND

Flat Single Flap Reinforced

Art.	€	Dimensions	Grit	rpm max
DF6600.112	€ 2,32	115 x 22 mm	40	13300
DF6600.114	€ 2,32	115 x 22 mm	60	13300
DF6600.115	€ 2,32	115 x 22 mm	80	13300
DF6600.117	€ 2,32	115 x 22 mm	120	13300
DF6600.122	€ 2,66	125 x 22 mm	40	12250
DF6600.124	€ 2,66	125 x 22 mm	60	12250
DF6600.125	€ 2,66	125 x 22 mm	80	12250
DF6600.127	€ 2,66	125 x 22 mm	120	12250
DF6600.182	€ 4,72	180 x 22 mm	40	8500
DF6600.184	€ 4,72	180 x 22 mm	60	8500



DF6700-Z

PERFORMANCE FLAP DISC TIGER

TIGER IS A FLAP DISC WITH AN ADDITIONAL 70% ABRASIVE CLOTH COMPARED TO STANDARD PROFESSIONAL DISCS. ITS SHAPE ALLOWS THE FULL USE OF THE ABRASIVE AS WELL AS MAKING IT PARTICULARLY COMPACT. THIS FEATURE, COMBINED TO REINFORCED SUPPORT, ALLOWS TO EXERT A HIGHER SPECIFIC PRESSURE AND CONSEQUENTLY A MORE RAPID REMOVAL.

Backing: Fiberglass Cloth: Zirconia **DIAMOND**  Flat  Single Flap

Art.	€	Dimensions	Grit	rpm max
DF6700.112	€ 2,23	115 x 22 mm	40	13300
DF6700.114	€ 2,23	115 x 22 mm	60	13300
DF6700.115	€ 2,23	115 x 22 mm	80	13300
DF6700.117	€ 2,23	115 x 22 mm	120	13300

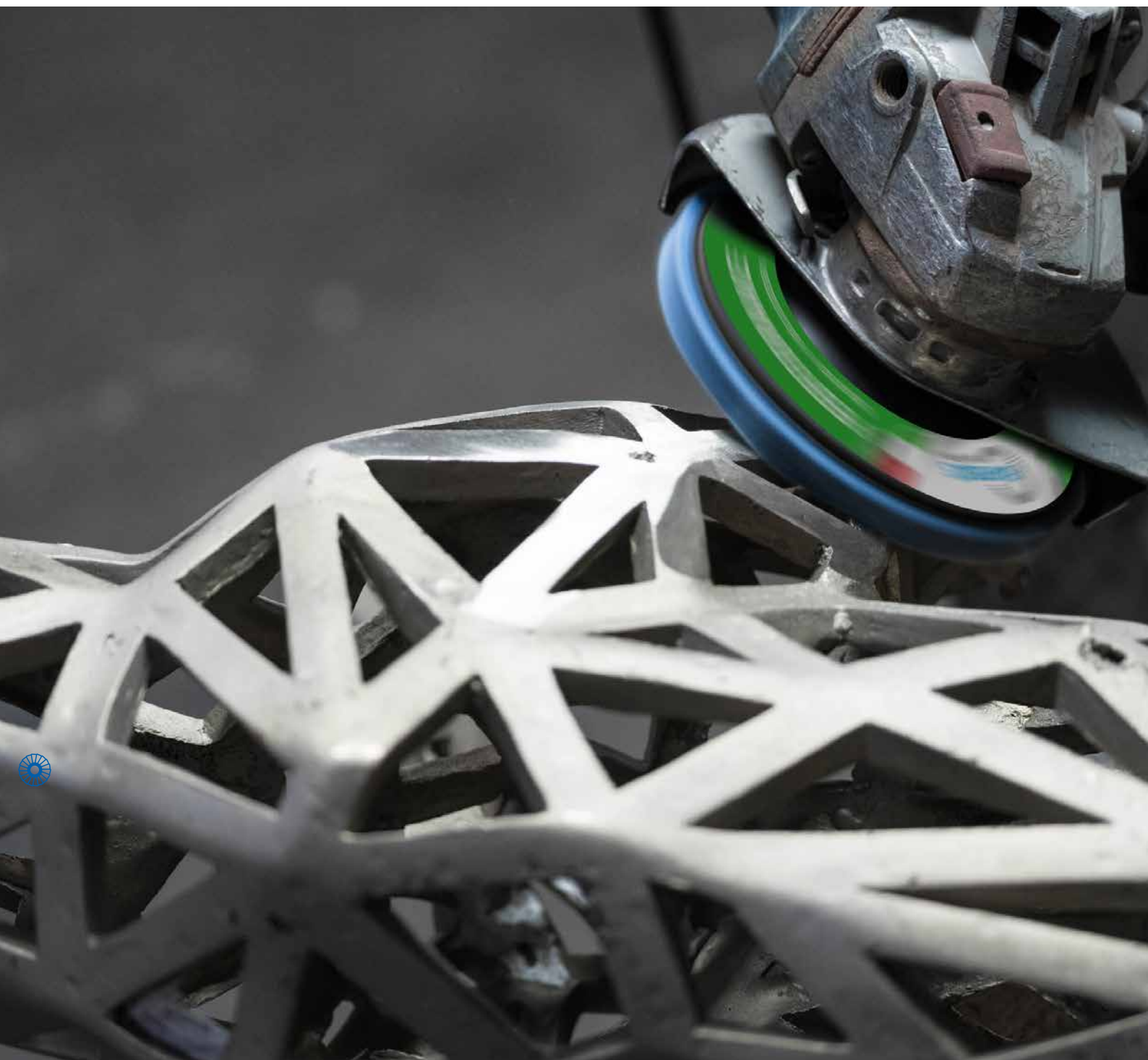

DF6100-A

PERFORMANCE FLAP DISC CLASSIC

Backing: Fiberglass Cloth: Aluminium oxide DIAMOND
 Flat Single Flap

Art.	€	Dimensions	Grit	rpm max
DF6100.212	€ 1,80	115 x 22 mm	40	13300
DF6100.214	€ 1,80	115 x 22 mm	60	13300
DF6100.215	€ 1,80	115 x 22 mm	80	13300
DF6100.217	€ 1,80	115 x 22 mm	120	13300



DF6150-A

PERFORMANCE FLAP DISC CLASSIC

Backing: Fiberglass Cloth: Aluminium oxide DIAMOND
 Conical Single Flap

Art.	€	Dimensions	Grit	rpm max
DF6150.212	€ 1,80	115 x 22 mm	40	13300
DF6150.214	€ 1,80	115 x 22 mm	60	13300
DF6150.215	€ 1,80	115 x 22 mm	80	13300
DF6150.217	€ 1,80	115 x 22 mm	120	13300



DN6100-A

PERFORMANCE FLAP DISC CLASSIC

Backing: Nylon Cloth: Aluminium oxide DIAMOND
 Flat Single Flap

Art.	€	Dimensions	Grit	rpm max
DN6100.212	€ 1,80	115 x 22 mm	40	13300
DN6100.214	€ 1,80	115 x 22 mm	60	13300
DN6100.215	€ 1,80	115 x 22 mm	80	13300
DN6100.217	€ 1,80	115 x 22 mm	120	13300

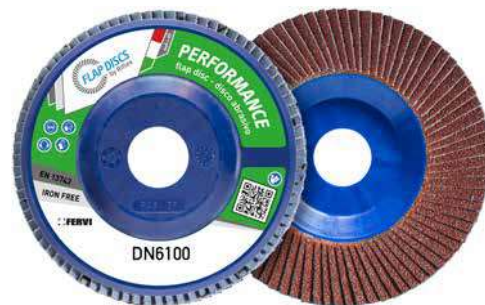

DN6300-A

PERFORMANCE FLAP DISC DUAL FLAP

Backing: Nylon Cloth: Aluminium oxide DIAMOND
 Flat Double Flap

Art.	€	Dimensions	Grit	rpm max
DN6300.212	€ 1,80	115 x 22 mm	40	13300
DN6300.214	€ 1,80	115 x 22 mm	60	13300
DN6300.215	€ 1,80	115 x 22 mm	80	13300
DN6300.217	€ 1,80	115 x 22 mm	120	13300





PROFESSIONAL TOP LINE

Professional long-life discs with high removal speeds for the most demanding users, powered by Norton™ abrasive cloth.

For heavy removal, major deburring - Designed for professional users and medium and large companies. Ideal for machining large metal sheets, removing large weld seams and requiring long disk life.

RECOMMENDED SPEED

Ø	RPM
115	5000/7500
125	4800/7300
180	3250/4900

DF8100-Z

PROFESSIONAL FLAP DISC CLASSIC

Backing: Fiberglass Cloth: Zirconia PLATINUM Flat Single Flap

Art.	€	Dimensions	Grit	rpm max
DF8100.111	€ 2,06	115 x 22 mm	36	13300
DF8100.112	€ 2,06	115 x 22 mm	40	13300
DF8100.114	€ 2,06	115 x 22 mm	60	13300
DF8100.115	€ 2,06	115 x 22 mm	80	13300
DF8100.117	€ 2,06	115 x 22 mm	120	13300
DF8100.121	€ 2,58	125 x 22 mm	36	12250
DF8100.122	€ 2,58	125 x 22 mm	40	12250
DF8100.124	€ 2,58	125 x 22 mm	60	12250
DF8100.125	€ 2,58	125 x 22 mm	80	12250
DF8100.181	€ 4,29	180 x 22 mm	36	8500
DF8100.182	€ 4,29	180 x 22 mm	40	8500
DF8100.184	€ 4,29	180 x 22 mm	60	8500
DF8100.185	€ 4,29	180 x 22 mm	80	8500



DF8150-Z

PROFESSIONAL FLAP DISC CLASSIC

Backing: Fiberglass Cloth: Zirconia PLATINUM Conical Single Flap

Art.	€	Dimensions	Grit	rpm max
DF8150.111	€ 2,06	115 x 22 mm	36	13300
DF8150.112	€ 2,06	115 x 22 mm	40	13300
DF8150.114	€ 2,06	115 x 22 mm	60	13300
DF8150.115	€ 2,06	115 x 22 mm	80	13300
DF8150.117	€ 2,06	115 x 22 mm	120	13300
DF8150.121	€ 2,58	125 x 22 mm	36	12250
DF8150.122	€ 2,58	125 x 22 mm	40	12250
DF8150.124	€ 2,58	125 x 22 mm	60	12250
DF8150.125	€ 2,58	125 x 22 mm	80	12250
DF8150.181	€ 4,29	180 x 22 mm	36	8500
DF8150.182	€ 4,29	180 x 22 mm	40	8500
DF8150.184	€ 4,29	180 x 22 mm	60	8500
DF8150.185	€ 4,29	180 x 22 mm	80	8500



DN8100-Z

PROFESSIONAL FLAP DISC CLASSIC

Backing: Nylon Cloth: Zirconia PLATINUM Flat Single Flap

Art.	€	Dimensions	Grit	rpm max
DN8100.111	€ 2,06	115 x 22 mm	36	13300
DN8100.112	€ 2,06	115 x 22 mm	40	13300
DN8100.114	€ 2,06	115 x 22 mm	60	13300
DN8100.115	€ 2,06	115 x 22 mm	80	13300
DN8100.117	€ 2,06	115 x 22 mm	120	13300
DN8100.122	€ 2,58	125 x 22 mm	40	12250
DN8100.124	€ 2,58	125 x 22 mm	60	12250
DN8100.125	€ 2,58	125 x 22 mm	80	12250
DN8100.182	€ 4,29	180 x 22 mm	40	8500
DN8100.184	€ 4,29	180 x 22 mm	60	8500
DN8100.185	€ 4,29	180 x 22 mm	80	8500



DN8300-Z

PROFESSIONAL FLAP DISC DUAL FLAP

Backing: Nylon Cloth: Zirconia PLATINUM Flat Double Flap

Art.	€	Dimensions	Grit	rpm max
DN8300.111	€ 2,06	115 x 22 mm	36	13300
DN8300.112	€ 2,06	115 x 22 mm	40	13300
DN8300.114	€ 2,06	115 x 22 mm	60	13300
DN8300.115	€ 2,06	115 x 22 mm	80	13300
DN8300.117	€ 2,06	115 x 22 mm	120	13300
DN8300.122	€ 2,58	125 x 22 mm	40	12250
DN8300.124	€ 2,58	125 x 22 mm	60	12250
DN8300.125	€ 2,58	125 x 22 mm	80	12250
DN8300.182	€ 4,29	180 x 22 mm	40	8500
DN8300.184	€ 4,29	180 x 22 mm	60	8500
DN8300.185	€ 4,29	180 x 22 mm	80	8500

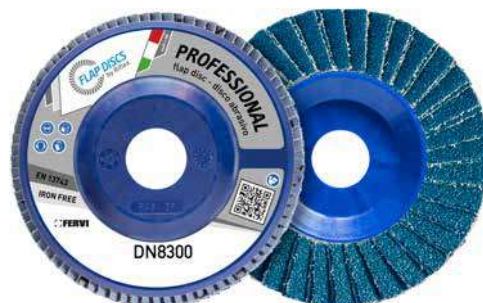

DN8550-Z

PROFESSIONAL FLAP DISC REAL FLAT

THANKS TO A SPECIAL CONVEX SHAPE BACKING, THIS FLAP DISCS TYPE ARE PERFECTLY FLAT DISCS WITH LARGE FLAPS AND CONSTANT DENSITY AND HARDNESS BOTH AT THE CENTRE AND ON THE PERIPHERAL DIAMETER OF THE DISC.

Backing: Nylon Cloth: Zirconia PLATINUM Concave Double Flap

Art.	€	Dimensions	Grit	rpm max
DN8550.112	€ 3,00	115 x 22 mm	40	13300
DN8550.114	€ 3,00	115 x 22 mm	60	13300
DN8550.115	€ 3,00	115 x 22 mm	80	13300
DN8550.117	€ 3,00	115 x 22 mm	120	13300



DF8600-Z

PROFESSIONAL FLAP DISC BIGGER

GRIND EVEN LONGER, EVEN FASTER, AND EVEN BETTER FINISHING WITH BIGGER DISC. THE NEW STRUCTURE PROVIDES BETTER BENEFITS COMPARED TO CONVENTIONAL FLAP OR GRINDING DISCS: 50% MORE ABRASION CAPACITY, SAVING A GREAT DEAL OF WORKING TIME, 2X LONGER SERVICE LIFE, EXCELLENT VALUE FOR MONEY, COOLER GRINDING, COSTS AND WORKING TIME REDUCTION

Backing: Fiberglass Cloth: Zirconia PLATINUM Flat Single Flap Reinforced

Art.	€	Dimensions	Grit	rpm max
DF8600.112	€ 2,49	115 x 22 mm	40	13300
DF8600.114	€ 2,49	115 x 22 mm	60	13300
DF8600.115	€ 2,49	115 x 22 mm	80	13300
DF8600.117	€ 2,49	115 x 22 mm	120	13300
DF8600.122	€ 2,92	125 x 22 mm	40	12250
DF8600.124	€ 2,92	125 x 22 mm	60	12250
DF8600.125	€ 2,92	125 x 22 mm	80	12250
DF8600.127	€ 2,92	125 x 22 mm	120	12250
DF8600.182	€ 5,10	180 x 22 mm	40	8500
DF8600.184	€ 5,10	180 x 22 mm	60	8500
DF8600.185	€ 5,10	180 x 22 mm	80	8500
DF8600.187	€ 5,10	180 x 22 mm	120	8500



DF8700-Z

PROFESSIONAL FLAP DISC TIGER

TIGER IS A FLAP DISC WITH AN ADDITIONAL 70% ABRASIVE CLOTH COMPARED TO STANDARD PROFESSIONAL DISCS. ITS SHAPE ALLOWS THE FULL USE OF THE ABRASIVE AS WELL AS MAKING IT PARTICULARLY COMPACT. THIS FEATURE, COMBINED TO REINFORCED SUPPORT, ALLOWS TO EXERT A HIGHER SPECIFIC PRESSURE AND CONSEQUENTLY A MORE RAPID REMOVAL.

Backing: Fiberglass Cloth: Zirconia PLATINUM
 Flat Single Flap Reinforced

Art.	€	Dimensions	Grit	rpm max
DF8700.112	€ 2,58	115 x 22 mm	40	13300
DF8700.114	€ 2,58	115 x 22 mm	60	13300
DF8700.115	€ 2,58	115 x 22 mm	80	13300
DF8700.117	€ 2,58	115 x 22 mm	120	13300

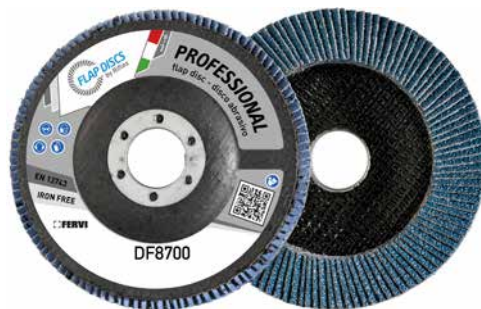

DF8100-A

PROFESSIONAL FLAP DISC CLASSIC

Backing: Fiberglass Cloth: Aluminium oxide PLATINUM
 Flat Single Flap

Art.	€	Dimensions	Grit	rpm max
DF8100.212	€ 1,97	115 x 22 mm	40	13300
DF8100.214	€ 1,97	115 x 22 mm	60	13300
DF8100.215	€ 1,97	115 x 22 mm	80	13300
DF8100.217	€ 1,97	115 x 22 mm	120	13300



DF8150-A

PROFESSIONAL FLAP DISC CLASSIC

Backing: Fiberglass Cloth: Aluminium oxide PLATINUM
 Conical Single Flap

Art.	€	Dimensions	Grit	rpm max
DF8150.212	€ 1,97	115 x 22 mm	40	13300
DF8150.214	€ 1,97	115 x 22 mm	60	13300
DF8150.215	€ 1,97	115 x 22 mm	80	13300
DF8150.217	€ 1,97	115 x 22 mm	120	13300



DN8100-A

PROFESSIONAL FLAP DISC CLASSIC

Backing: Nylon Cloth: Aluminium oxide PLATINUM
 Flat Single Flap

Art.	€	Dimensions	Grit	rpm max
DN8100.212	€ 1,97	115 x 22 mm	40	13300
DN8100.214	€ 1,97	115 x 22 mm	60	13300
DN8100.215	€ 1,97	115 x 22 mm	80	13300
DN8100.217	€ 1,97	115 x 22 mm	120	13300

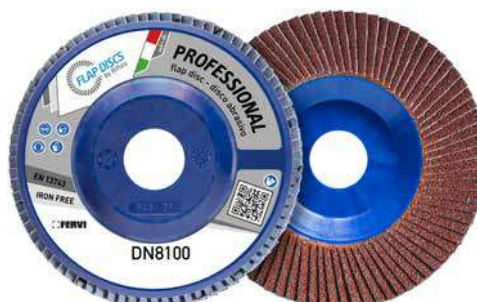

DN8300-A

PROFESSIONAL FLAP DISC DUAL FLAP

Backing: Nylon Cloth: Aluminium oxide PLATINUM
 Flat Double Flap

Art.	€	Dimensions	Grit	rpm max
DN8300.212	€ 1,97	115 x 22 mm	40	13300
DN8300.214	€ 1,97	115 x 22 mm	60	13300
DN8300.215	€ 1,97	115 x 22 mm	80	13300
DN8300.217	€ 1,97	115 x 22 mm	120	13300



SPECIALTY INOX

SHARPER & FASTER

Best solution for machining of stainless steel surfaces. Ceramic cloth, additioned with cooling “top size” layer.

For applications in the food, pharmaceutical and chemical industries. Designed for stainless steel specialists. Ideal for processing thin sheets, important burrs of weld seams and where a temperature-resistant product is required.

RECOMMENDED SPEED

Ø	RPM
115	5000/7500
125	4800/7300
180	3250/4900

SPECIALTY INOX is a flap disc composed by an abrasive cloth “TOP SIZE” with a mixture of **zirconia and ceramic abrasive grain**. These high quality materials allow a **very high cutting speed** together with an **extraordinary disc life**. The further layer “TOP SIZE” drastically reduces the overheating of the disc and of the workpiece, with **obvious benefits when working on stainless steels**. The particularly strong fabric allows hard working pressures. The light blue color is by nature devoid of iron oxides so as to prevent contamination of stainless steels ($\geq 0,1\%$ Fe, S, Cl)

DF9100-ZC

ZIRCOCER FLAP DISC CLASSIC

Backing: Fiberglass Cloth: Zirconia + Ceramic
 Flat Single Flap

Art.	€	Dimensions	Grit	rpm max
DF9100.312	€ 2,75	115 x 22 mm	40+	13300
DF9100.314	€ 2,75	115 x 22 mm	60	13300
DF9100.322	€ 3,09	125 x 22 mm	40+	12250
DF9100.324	€ 3,09	125 x 22 mm	60	12250



DF9150-ZC

ZIRCOCER FLAP DISC CLASSIC

Backing: Fiberglass Cloth: Zirconia + Ceramic
 Conical Single Flap

Art.	€	Dimensions	Grit	rpm max
DF9150.312	€ 2,75	115 x 22 mm	40+	13300
DF9150.314	€ 2,75	115 x 22 mm	60	13300
DF9150.322	€ 3,09	125 x 22 mm	40+	12250
DF9150.324	€ 3,09	125 x 22 mm	60	12250





DN9100-ZC

ZIRCOCER FLAP DISC CLASSIC

Backing: Nylon Cloth: Zirconia + Ceramic
 Flat Single Flap

Art.	€	Dimensions	Grit	rpm max
DN9100.312	€ 2,75	115 x 22 mm	40+	13300
DN9100.314	€ 2,75	115 x 22 mm	60	13300
DN9100.322	€ 3,09	125 x 22 mm	40+	12250
DN9100.324	€ 3,09	125 x 22 mm	60	12250



DF9800-ZC

ZIRCOCER FLAP DISC RAPTOR

RAPTOR HAS HIGHER CUTTING SPEED AND MAXIMUM REMOVAL POWER THANKS TO ITS PARTICULAR SHAPE

Backing: Fiberglass Cloth: Zirconia + Ceramic
 Flat Single Flap

Art.	€	Dimensions	Grit	rpm max
DF9800.312	€ 2,49	115 x 22 mm	40	13300
DF9800.322	€ 2,75	125 x 22 mm	40	12250



SPECIALTY ALU

LOW TEMPERATURES, HIGH PERFORMANCE.

Ideal disc for machining aluminum surfaces,
with Abranet® Max canvas.

For deburring and finishing on aluminum and non-ferrous materials and where the problem of clogging is present.

SPECIALTY ALU IS A SPECIAL DISC DESIGNED FOR ALUMINUM PROCESSING AND, IN GENERAL, FOR ALL NON-FERROUS METALS AND COMPOSITE MATERIALS. IT IS MADE WITH A SPECIAL POLYAMIDE NET SUPPORT THAT AVOIDS CLOGGING OF THE ABRASIVE AND ALLOWS THE PROCESSING OF THE MATERIAL AT LOW TEMPERATURE.

DF9103-M

CAT 42

SPECIALTY ALU FLAP DISC CLASSIC

Backing: Fiberglass Cloth: Abranet
 Flat Single flap

Art.	€	Overall sizes	Grit	rpm max
DF9103.512	€ 3,42	115 x 22 mm	40	13300
DF9103.514	€ 3,42	115 x 22 mm	60	13300
DF9103.515	€ 3,42	115 x 22 mm	80	13300
DF9103.517	€ 3,42	115 x 22 mm	120	13300
DF9103.522	€ 4,42	125 x 22 mm	40	12250
DF9103.524	€ 4,42	125 x 22 mm	60	12250
DF9103.525	€ 4,42	125 x 22 mm	80	12250
DF9103.527	€ 4,42	125 x 22 mm	120	12250



DF9153-M

CAT 42

SPECIALTY ALU FLAP DISC CLASSIC

Backing: Fiberglass Cloth: Abranet
 Conical Single flap

Art.	€	Overall sizes	Grit	rpm max
DF9153.512	€ 3,42	115 x 22 mm	40	13300
DF9153.514	€ 3,42	115 x 22 mm	60	13300
DF9153.515	€ 3,42	115 x 22 mm	80	13300
DF9153.517	€ 3,42	115 x 22 mm	120	13300
DF9153.522	€ 4,42	125 x 22 mm	40	12250
DF9153.524	€ 4,42	125 x 22 mm	60	12250
DF9153.525	€ 4,42	125 x 22 mm	80	12250
DF9153.527	€ 4,42	125 x 22 mm	120	12250



ZTD8x

CAT 42

PROFESSIONAL ZIRCONIA CUTTING DISC

FOR SPECIFIC USES ON THIN STEEL AND STAINLESS STEEL SHEETS. DESIGNED FOR PROFESSIONAL USE, IT GUARANTEES CLEAN AND PRECISE CUTS WITHOUT BURRS AND "BURNS". UNIQUE DISC OF ITS KIND.

EN 12413 Depressed center

Art.	€	Overall sizes	Size	Cut range
ZTD8115/1.0	€ 2,08	115 x 1,0 x 22 mm	ZA-60-SXBF	25*
ZTD8125/1.0	€ 2,28	125 x 1,0 x 22 mm	ZA-60-SXBF	25*



ZSD8x

CAT 42

PROFESSIONAL ZIRCONIA GRINDING DISC

FOR SPECIFIC AND HEAVY USES. DESIGNED FOR PROFESSIONAL USE. IDEAL FOR FAST REMOVAL OF WELD SEAMS, CAULKING, REMOVAL OF CALAMINE AND PIPES (SEE OIL & GAS). HAS ALSO APPLICATIONS ON CAST IRON, STAINLESS STEEL FORGED MATERIALS.

EN 12413 Depressed center

Art.	€	Overall sizes	Size	Cut range
ZSD8115/7.0	€ 3,75	115 x 7,0 x 22 mm	ZA-60-SXBF	25*
ZSD8125/7.0	€ 4,33	125 x 7,0 x 22 mm	ZA-60-SXBF	25*
ZSD8230/7.0	€ 11,90	230 x 7,0 x 22 mm	ZA-60-SXBF	25*



MTP8x

PROFESSIONAL CUTTING DISC

FOR

SPECIFIC USES. DESIGNED FOR PROFESSIONALS WHO NEED A HIGH NUMBER OF HIGH QUALITY CUTS. IN THICKNESSES 1.3-1, 6- 2.0 MM THEY HAVE A RIBBED CONFORMATION ON BOTH SIDES, WHICH ALLOWS FOR A FASTER AND COLDER CUT.

EN 12413 Flat

Art.	€	Dimensions	Specification
MTP8115/1.0	€ 1,48	115 x 1,0 x 22 mm	A60S
MTP8115/1.3	€ 1,52	115 x 1,3 x 22 mm	A60S
MTP8115/1.6	€ 1,57	115 x 1,6 x 22 mm	A60S
MTP8125/1.0	€ 1,58	125 x 1,0 x 22 mm	A60S
MTP8125/1.3	€ 1,62	125 x 1,3 x 22 mm	A60S
MTP8125/1.6	€ 1,75	125 x 1,6 x 22 mm	A60S
MTP8230/2.0	€ 3,30	230 x 2,0 x 22 mm	A60S



MSD8x

PROFESSIONAL GRINDING DISC

FOR SPECIFIC USES. DESIGNED FOR PROFESSIONALS WHO NEED HIGH REMOVAL CAPACITY AND FATIGUE RESISTANCE. IDEAL ON PLATES WITH CALAMINE, FOR REMOVING IMPORTANT BEADS AND BURRS.

EN 12413 Depressed center

Art.	€	Dimensions	Specification
MSD8115/6.5	€ 2,25	115 x 6,5 x 22 mm	A-Q
MSD8125/6.5	€ 2,47	125 x 6,5 x 22 mm	A-Q
MSD8230/7.0	€ 6,00	230 x 7,0 x 22 mm	A-Q



MTP9x

INOX CUTTING DISC

FOR SPECIFIC USES. DESIGNED FOR PROFESSIONALS WORKING WITH STAINLESS STEEL WHO NEED A HIGH NUMBER OF HIGH QUALITY CUTS. IN THICKNESSES 1.3-1, 6- 2.0 MM THEY HAVE A RIBBED CONFORMATION ON BOTH SIDES THAT ALLOWS FOR A FASTER AND COLDER CUT.

EN 12413 Flat

Art.	€	Dimensions	Specification
MTP9115/1.0	€ 1,60	115 x 1,0 x 22 mm	A60SX
MTP9115/1.3	€ 1,70	115 x 1,3 x 22 mm	A60SX
MTP9115/1.6	€ 1,77	115 x 1,6 x 22 mm	A60SX
MTP9125/1.0	€ 1,75	125 x 1,0 x 22 mm	A60SX
MTP9125/1.3	€ 1,90	125 x 1,3 x 22 mm	A60SX
MTP9125/1.6	€ 1,95	125 x 1,6 x 22 mm	A60SX
MTP9230/2.0	€ 4,08	230 x 2,0 x 22 mm	A60SX



MTP7x

CAT 42

PROFESSIONAL CUTTING DISC FOR ALUMINIUM

For specific uses. Designed for professionals working with aluminium and frame makers. Ideal on aluminium boxes, light alloy foundries and a high number of high quality cuts is required. Available in the dimensions 115x1.3 and 125x 1.3 mm, in which it has a ribbed conformation on both sides that allows for a faster and colder cut, with low clogging.

EN 12413 Flat

Art.	€	Overall sizes	Specification
MTP7115/1.3	€ 1,63	115 x 1,3 x 22 mm	A-60-QAL
MTP7125/1.3	€ 2,00	125 x 1,3 x 22 mm	A-60-QAL



MTD7x

CAT 42

PROFESSIONAL CUTTING DISC FOR ALUMINIUM

FOR SPECIFIC USES. DESIGNED FOR PROFESSIONALS WORKING WITH ALUMINIUM AND FRAME MAKERS. IDEAL ON ALUMINIUM BOXES, LIGHT ALLOY FOUNDRIES AND A HIGH NUMBER OF HIGH QUALITY CUTS IS REQUIRED. THE 230X3.2 DIAMETER IS MADE WITHOUT THE RIBBED CONFORMATION BUT HAS SPECIFIC ANTI-CLOGGING ADDITIVES.

EN 12413 Depressed center

Art.	€	Overall sizes	Specification
MTD7230/3.2	€ 4,50	230 x 3,2 x 22 mm	A-30-36-QAL



MSD7x

CAT 42

PROFESSIONAL GRINDING DISC FOR ALUMINIUM

FOR SPECIFIC USES. DESIGNED FOR PROFESSIONALS WORKING WITH ALUMINIUM. IDEAL IN LIGHT ALLOY FOUNDRIES, ON ALUMINUM BOXES AND WHERE THE REMOVAL OF BURRS AND FILLINGS IS REQUIRED. IT HAS SPECIFIC ANTI-CLOGGING ADDITIVES.

EN 12413 Depressed center

Art.	€	Overall sizes	Specification
MSD7230/7.0	€ 8,30	230 x 7,0 x 22 mm	A-24-30-36-QAL



FDCx

CAT 42

VIPER SEMI FLEXIBLE FIBER DISC

INNOVATIVE SEMI FLEXIBLE DEPRESSED CENTER FIBERDISC WITH BUILT-IN BACKING PAD FOR A MORE PRECISE, FASTER AND COMFORTABLE GRINDING OF WELDING SEAMS, SHARP EDGES, FLAT AND CURVED SURFACES.

Art.	€	Overall sizes	Hardness	rpm max
FDC115/036	€ 4,03	115x22,23 mm	SG 36	13300
FDC115/060	€ 4,03	115x22,23 mm	SG 60	13300
FDC115/120	€ 4,03	115x22,23 mm	SG 120	13300
FDC125/036	€ 4,17	125x22.23 mm	SG 36	12250



MTP6x

***CAT 42**

PERFORMANCE CUTTING DISC

FOR GENERAL USES. DESIGNED FOR CRAFTSMEN AND SMALL BUSINESSES. IDEAL WHERE MASS PRODUCTION IS NOT REQUIRED WITH GOOD CUTTING QUALITY.

EN 12413 Flat

Art.	€	Dimensions	Specification
MTP6075/1.5	€ 1,33	75 x 1,5 x 10 mm	A46-S-BF 80
MTP6115/1.0	€ 1,17	115 x 1,0 x 22 mm	A46-R-BF 80
MTP6115/1.3	€ 1,17	115 x 1,3 x 22 mm	A46-R-BF 80
MTP6115/1.6	€ 1,17	115 x 1,6 x 22 mm	A46-R-BF 80
MTP6125/1.0	€ 1,25	125 x 1,0 x 22 mm	A46-S5-BF

Art.	€	Dimensions	Specification
MTP6125/1.3	€ 1,25	125 x 1,3 x 22 mm	A46-S5-BF
MTP6125/1.6	€ 1,25	125 x 1,6 x 22 mm	A46-S5-BF
MTP6230/2.0	€ 3,08	230 x 2,0 x 22 mm	A30-R-BF 80
MTP6350/3.0	€ 9,30	350 x 3,0 x 25.4 mm	A46-S-BF 80



MTD6x

PERFORMANCE CUTTING DISC

FOR GENERAL USES. DESIGNED FOR CRAFTSMEN AND SMALL BUSINESSES. IDEAL WHERE MASS PRODUCTION IS NOT REQUIRED WITH GOOD CUTTING QUALITY.

EN 12413 Depressed center

Art.	€	Dimensions	Specification
MTD6115/3.0	€ 1,33	115 x 3,0 x 22 mm	A30-R-BF 80
MTD6125/3.2	€ 1,58	125 x 3,2 x 22 mm	A30-S-BF
MTD6230/3.0	€ 2,67	230 x 3,0 x 22 mm	A30-R-BF 80



MSD6x

PERFORMANCE GRINDING DISC

FOR GENERAL USES. DESIGNED FOR CRAFTSMEN AND SMALL BUSINESSES. IDEAL WHERE MASS PRODUCTION WORK IS NOT REQUIRED WITH GOOD QUALITY ON WELD SEAMS, SHEETS WITH CALAMINE AND TRIMMING IN GENERAL.

EN 12413 Depressed center

Art.	€	Dimensions	Specification
MSD6115/6.0	€ 1,83	115 x 6,0 x 22 mm	A24-R-BF 80
MSD6125/6.5	€ 2,17	125 x 6,5 x 22 mm	A30-S-BF
MSD6230/6.0	€ 5,10	230 x 6,0 x 22 mm	A24-R-BF 80



MTP4x

CAT 42

STRONG CUT CUTTING DISC

FOR GENERAL USES. DESIGNED FOR HOBBYISTS, ARTISANS AND SMALL BUSINESSES. IDEAL FOR BOTH STEEL AND STAINLESS STEEL, IN JOBS THAT DO NOT REQUIRE MASS PRODUCTION WITH GOOD CUTTING QUALITY.

EN 12413

Art.	€	Dimensions	Specification
MTP4075/1.5	€ 0,83	75 x 1.5 x 9.53 mm	A60TBF
MTP4115/1.0	€ 0,75	115 x 1.0 x 22 mm	A60TBF
MTP4115/1.3	€ 0,75	115 x 1.3 x 22 mm	A60TBF
MTP4115/1.6	€ 0,75	115 x 1.6 x 22 mm	A46TBF
MTP4125/1.0	€ 0,83	125 x 1.0 x 22 mm	A60TBF

Art.	€	Dimensions	Specification
MTP4125/1.3	€ 0,83	125 x 1.3 x 22 mm	A60TBF
MTP4125/1.6	€ 0,83	125 x 1.6 x 22 mm	A46TBF
MTP4230/2.0	€ 2,67	230 x 2.0 x 22 mm	A46TBF
MTP4350/3.0	€ 7,10	350 x 3.0 x 22 mm	A30SBF



MTD4x

CAT 42

STRONG CUT CUTTING DISC

FOR GENERAL USES. DESIGNED FOR HOBBYISTS, ARTISANS AND SMALL BUSINESSES. IDEAL FOR BOTH STEEL AND STAINLESS STEEL, IN JOBS THAT DO NOT REQUIRE MASS PRODUCTION WITH GOOD CUTTING QUALITY.

EN 12413

Art.	€	Dimensions	Specification
MTD4115/3.0	€ 1,00	115 x 3.0 x 22 mm	A30SBF
MTD4125/3.0	€ 1,25	125 x 3.0 x 22 mm	A30SBF
MTD4180/3.0	€ 1,83	180 x 3.0 x 22 mm	A30SBF
MTD4230/3.0	€ 2,42	230 x 3.0 x 22 mm	A30SBF



MSD4x

CAT 42

STRONG CUT GRINDING DISC

FOR GENERAL USES. DESIGNED FOR HOBBYISTS, ARTISANS AND SMALL BUSINESSES. IDEAL WHERE SERIES WORK IS NOT REQUIRED WITH GOOD QUALITY ON WELD SEAMS, SHEETS WITH CALAMINE AND TRIMMING IN GENERAL.

EN 12413

Art.	€	Dimensions	Specification
MSD4115/6.0	€ 1,42	115 x 6.0 x 22 mm	A24RBF
MSD4125/6.0	€ 1,75	125 x 6.0 x 22 mm	A24RBF
MSD4180/6.0	€ 3,58	180 x 6.0 x 22 mm	A24RBF
MSD4230/6.0	€ 4,58	230 x 6.0 x 22 mm	A24RBF



M16x

GRINDING WHEELS

PINK CORUNDUM

Art.	€	Dimensions	Specifications
M159	€ 6,90	Ø 100 x 4,5 x 10 mm	GR80
M160	€ 6,90	Ø 100 x 3,2 x 10 mm	GR80
M163	€ 12,70	Ø 145 x 3,2 x 22,3 mm	GR 80
M162	€ 12,70	Ø 145 x 4,7 x 22,3 mm	GR80



MVx

GRINDING WHEEL

GREEN SILICON CARBIDE, HIGH CUTTING AND FINISHING, FOR ALLOY TOOL SHARPENING

***CAT 42**

Art.	€	Dimensions	Grit	Adapters
MV01/80	€ 11,00	150 x 20 x 32 mm	80	12,7 - 16 - 20 - 25 mm
MV02/80	€ 13,10	200 x 20 x 32 mm	80	12,7 - 16 - 20 - 25 mm
MV03/80	€ 16,00	200 x 25 x 32 mm	80	12,7 - 16 - 20 - 25 mm
MV04/80	€ 25,20	250 x 25 x 32 mm	80	12,7 - 16 - 20 - 25 mm



MGx

GRINDING WHEEL

GREY CORUNDUM, TOUGH HARD STEELS GRINDING

***CAT 42**

Art.	€	Dimensions	Grit	Adapters
MG01/36	€ 6,60	150 x 20 x 32 mm	36	12,7 - 16 - 20 - 25 mm
MG01/46	€ 6,60	150 x 20 x 32 mm	46	12,7 - 16 - 20 - 25 mm
MG01/60	€ 6,60	150 x 20 x 32 mm	60	12,7 - 16 - 20 - 25 mm
MG01/80	€ 6,60	150 x 20 x 32 mm	80	12,7 - 16 - 20 - 25 mm
MG02/36	€ 7,00	200 x 20 x 32 mm	36	12,7 - 16 - 20 - 25 mm
MG02/46	€ 7,00	200 x 20 x 32 mm	46	12,7 - 16 - 20 - 25 mm
MG02/60	€ 7,00	200 x 20 x 32 mm	60	12,7 - 16 - 20 - 25 mm
MG02/80	€ 7,00	200 x 20 x 32 mm	80	12,7 - 16 - 20 - 25 mm
MG03/36	€ 9,30	200 x 25 x 32 mm	36	12,7 - 16 - 20 - 25 mm
MG03/46	€ 9,30	200 x 25 x 32 mm	46	12,7 - 16 - 20 - 25 mm
MG03/60	€ 9,30	200 x 25 x 32 mm	60	12,7 - 16 - 20 - 25 mm
MG03/80	€ 9,30	200 x 25 x 32 mm	80	12,7 - 16 - 20 - 25 mm
MG04/36	€ 14,10	250 x 25 x 32 mm	36	12,7 - 16 - 20 - 25 mm
MG04/46	€ 14,10	250 x 25 x 32 mm	46	12,7 - 16 - 20 - 25 mm
MG04/60	€ 14,10	250 x 25 x 32 mm	60	12,7 - 16 - 20 - 25 mm
MG04/80	€ 14,10	250 x 25 x 32 mm	80	12,7 - 16 - 20 - 25 mm
MG06/80	€ 17,40	200 x 40 x 20 mm	80	- mm



MBx

GRINDING WHEEL

WHITE CORUNDUM, FOR STEEL FINISHING

***CAT 42**

Art.	€	Dimensions	Grit	Adapters
MB01/60	€ 6,90	150 x 20 x 32 mm	60	12,7 - 16 - 20 - 25 mm
MB02/60	€ 7,30	200 x 20 x 32 mm	60	12,7 - 16 - 20 - 25 mm
MB03/60	€ 9,80	200 x 25 x 32 mm	60	12,7 - 16 - 20 - 25 mm
MB04/60	€ 20,10	250 x 25 x 32 mm	60	12,7 - 16 - 20 - 25 mm



MCGxA

***CAT 42**

VITRIFIED MOUNTED POINTS

CYLINDRICAL SHAPE "A" SUITED FOR GRINDING AND FINISHING SMALL OR HARD TO REACH SURFACES: UNHARDENED STEELS, ALLOYED STEELS, CAST IRON.

PACKING OF 25* PIECES



Art.	€	Size	Shank	rpm max
MCG0306/03A	€ 0,48	Ø 3 x 6 mm	3 mm	50000
MCG0408/03A	€ 0,48	Ø 4 x 8 mm	3 mm	50000
MCG0510/03A	€ 0,48	Ø 5 x 10 mm	3 mm	50000
MCG0610/03A	€ 0,48	Ø 6 x 10 mm	3 mm	47750
MCG0610/06A	€ 0,48	Ø 6 x 10 mm	6 mm	47750
MCG0810/03A	€ 0,48	Ø 8 x 10 mm	3 mm	38590
MCG0810/06A	€ 0,48	Ø 8 x 10 mm	6 mm	38590
MCG1010/03A	€ 0,57	Ø 10 x 10 mm	3 mm	28640
MCG1010/06A	€ 0,75	Ø 10 x 10 mm	6 mm	28640
MCG1020/06A	€ 0,79	Ø 10 x 20 mm	6 mm	28640
MCG1520/06A	€ 0,84	Ø 15 x 20 mm	6 mm	19000
MCG1530/06A	€ 1,07	Ø 15 x 30 mm	6 mm	19000
MCG2020/06A	€ 1,07	Ø 20 x 20 mm	6 mm	14320
MCG2025/06A	€ 1,25	Ø 20 x 25 mm	6 mm	14320
MCG2030/06A	€ 1,36	Ø 20 x 30 mm	6 mm	14320
MCG2525/06A	€ 1,25	Ø 25 x 25 mm	6 mm	11460
MCG3030/06A	€ 1,74	Ø 30 x 30 mm	6 mm	9540
MCG4020/06A	€ 2,27	Ø 40 x 20 mm	6 mm	7150
MCG4040/06A	€ 3,27	Ø 40 x 40 mm	6 mm	7150
MCG5010/06A	€ 2,27	Ø 50 x 10 mm	6 mm	5750

MCG10/06S

CAT 42

VITRIFIED MOUNTED POINTS

PACKING OF 25* PIECES



Art.	€	Size	Shank	rpm max
MCG10/06S	€ 0,98	Ø 10 mm	6 mm	28640
MCG15/06S	€ 0,88	Ø 15 mm	6 mm	19000
MCG20/06S	€ 1,22	Ø 20 mm	6 mm	14320
MCG25/06S	€ 1,78	Ø 25 mm	6 mm	11460
MCG30/06S	€ 1,92	Ø 30 mm	6 mm	9540

MBGxA

RESINOID BAKELITE POINTS

CONICAL SHAPE "C" SUITED FOR GRINDING AND FINISHING SMALL OR HARD TO REACH SURFACES: UNHARDENED STEELS, ALLOYED STEELS, CAST IRON.



Art.	€	Size	Shank
MBG1030/06A	€ 1,36	Ø 10 x 30 mm	6 mm
MBG1530/06A	€ 1,48	Ø 15 x 30 mm	6 mm
MBG2020/06A	€ 1,32	Ø 20 x 20 mm	6 mm
MBG2030/06A	€ 1,53	Ø 20 x 30 mm	6 mm
MBG2040/06A	€ 1,94	Ø 20 x 40 mm	6 mm
MBG2525/06A	€ 1,53	Ø 25 x 25 mm	6 mm
MBG2535/06A	€ 1,82	Ø 25 x 35 mm	6 mm
MBG3010/06A	€ 1,25	Ø 30 x 10 mm	6 mm
MBG3030/06A	€ 1,76	Ø 30 x 30 mm	6 mm
MBG4020/06A	€ 2,22	Ø 40 x 20 mm	6 mm
MBG4035/06A	€ 2,90	Ø 40 x 35 mm	6 mm
MBG5010/06A	€ 2,22	Ø 50 x 10 mm	6 mm

MCGxC

VITRIFIED MOUNTED POINTS

CONICAL SHAPE "C" SUITED FOR GRINDING AND FINISHING SMALL OR HARD TO REACH SURFACES: UNHARDENED STEELS, ALLOYED STEELS, CAST IRON.

PACKING OF 25* PIECES



Art.	€	Size	Shank	rpm max
MCG1020/06C	€ 0,90	10 x 20 mm	6 mm	28640
MCG1520/06C	€ 0,98	15 x 20 mm	6 mm	19000
MCG1540/06C	€ 1,63	15 x 40 mm	6 mm	19000
MCG2030/06C	€ 1,36	20 x 30 mm	6 mm	14320
MCG2540/06C	€ 2,44	25 x 40 mm	6 mm	11460
MCG3040/06C	€ 2,20	30 x 40 mm	6 mm	9540

MCG2050/06G

CAT 42 € 2,17

VITRIFIED MOUNTED POINTS

OGIVE SHAPE "G" SUITED FOR GRINDING AND FINISHING SMALL OR HARD TO REACH SURFACES: UNHARDENED STEELS, ALLOYED STEELS, CAST IRON.

PACKING OF 25* PIECES



Size	Ø 20 x 50 mm
Shank	6 mm
rpm max	14320

MBGxC

RESINOID BAKELITE POINTS

CONICAL SHAPE "C" SUITED FOR GRINDING AND FINISHING SMALL OR HARD TO REACH SURFACES: UNHARDENED STEELS, ALLOYED STEELS, CAST IRON.



Art.	€	Size	Shank
MBG1540/06C	€ 2,31	Ø 15 x 40 mm	6 mm
MBG2040/06C	€ 2,49	Ø 20 x 40 mm	6 mm
MBG2535/06C	€ 2,31	Ø 25 x 35 mm	6 mm



0163

€ 7,50

10-PC MOUNTED GRINDING SET



Blister

Shank \varnothing 3 - 6 mm

0816

€ 5,80

SHARPENING STONE (SILICON CARBIDE)



Blister

Overall sizes 200 x 50 x 25h mm

0817

€ 5,50

SHARPENING STONE (ALUMINUM OXIDE)



Blister

Overall sizes 200 x 50 x 25h mm

D100

€ 41,70

**PEN TYPE DIAMOND DRESSER
NATURAL TYPE**



Shank \varnothing 10 mm
Length 48 mm
Carats 1

D100/S

€ 28,80

**PEN TYPE DIAMOND DRESSER
SINTETIC TYPE**



Shank \varnothing 10 mm
Length 48 mm
Carats 1

0833

€ 56,60

**TURBO POLISHING DIAMOND CUP WHEEL FOR GRANITE AND
STONE**



Dimension \varnothing 100 mm
Hole \varnothing 22,2 mm
Dry - Wet



D040-

CAT 42

DIAMOND CUP WHEEL



Art.	€	Diameter	Hole	Segments	rpm max
D040/115	€ 24,20	ø 115 mm	ø 22,2 mm	8 + 8	13300
D040/180	€ 48,50	ø 180 mm	ø 22,2 mm	12 + 12	8500

D045-

CAT 42

DIAMOND SAW BLADES CONTINUOUS RIM

Art.	€	Diameter	Hole	Diamond height	Cut thickness	rpm max
D045/115	€ 4,53	ø 115 mm	ø 22,2 mm	5 mm	2.0 mm	13300
D045/180	€ 13,20	ø 180 mm	ø 22,2 mm	5 mm	2.4 mm	8500
D045/230	€ 18,60	ø 230 mm	ø 22,2 mm	5 mm	2.8 mm	6600



D070-

CAT 42

PROFESSIONAL DIAMOND SAW BLADES FOR PORCELAIN GRES, TILES, HARD CERAMICS

Art.	€	Diameter	Hole	Diamond height	Cut thickness	rpm max
D070/115	€ 24,60	ø 115 mm	ø 22,2 mm	10 mm	1.3 mm	13300
D070/180	€ 50,90	ø 180 mm	ø 22,2 mm	10 mm	1.6 mm	8500
D070/230	€ 72,00	ø 230 mm	ø 22,2 mm	10 mm	2.0 mm	6600



D060-

CAT 42

PROFESSIONAL VENTILATED DIAMOND DISCS

Art.	€	Diameter	Hole	Diamond height	Cut thickness	rpm max
D060/115	€ 12,50	ø 115 mm	ø 22,2 mm	7 mm	1.4 mm	13300
D060/180	€ 44,50	ø 180 mm	ø 22,2 mm	7 mm	1.8 mm	8500
D060/230	€ 62,10	ø 230 mm	ø 22,2 mm	10 mm	2.4 mm	6600



D059-

CAT 42

VENTILATED DIAMOND SAW BLADES

Art.	€	Diameter	Hole	Diamond height	Cut thickness	rpm max
D059/115	€ 7,30	ø 115 mm	ø 22,2 mm	7 mm	2.0 mm	13300
D059/180	€ 18,60	ø 180 mm	ø 22,2 mm	7 mm	2.4 mm	8500
D059/230	€ 34,50	ø 230 mm	ø 22,2 mm	10 mm	2.8 mm	6600



D054-

CAT 42

SEGMENTED VENTILATED DIAMOND DISCS

Art.	€	Diameter	Hole	Diamond height	Segments	Cut thickness	rpm max
D054/115	€ 5,70	ø 115 mm	ø 22,2 mm	7 mm	9	2.0 mm	13300
D054/180	€ 16,10	ø 180 mm	ø 22,2 mm	7 mm	14	2.4 mm	8500
D054/230	€ 23,90	ø 230 mm	ø 22,2 mm	7 mm	18	2.8 mm	6600



D055-

CAT 42

PROFESSIONAL SEGMENTED VENTILATED DIAMOND DISCS

Art.	€	Diameter	Hole	Diamond height	Segments	Cut thickness	rpm max
D055/115	€ 14,00	ø 115 mm	ø 22,2 mm	7 mm	9	1.9 mm	13300
D055/180	€ 40,70	ø 180 mm	ø 22,2 mm	7 mm	14	2.2 mm	8500
D055/230	€ 62,10	ø 230 mm	ø 22,2 mm	7 mm	18	2.6 mm	6600



0350

€ 42,20

SUPER TURBO DIAMOND BLADE



Dimension	ø 230 mm
Hole	ø 22,2 mm
Dry - Wet	

0709

€ 11,50

SUPER TURBO DIAMOND BLADE



Dimension	ø 115 mm
Hole	ø 22,2 mm
Dry - Wet	



AxSC

CAT 42

SINGLE CUT ROTARY BURRS

Tungsten Carbide

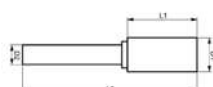

Art.	€	D1	L1	D2	L2
A02SC3	€ 3,75	ø2 mm	10 mm	3 mm	38 mm
A06SC6	€ 10,40	ø6 mm	16 mm	6 mm	61 mm
A08SC6	€ 11,70	ø8 mm	20 mm	6 mm	65 mm
A10SC6	€ 14,60	ø10 mm	20 mm	6 mm	65 mm
A12SC6	€ 21,30	ø12 mm	25 mm	6 mm	70 mm
A16SC6	€ 33,30	ø16 mm	25 mm	6 mm	70 mm

AxDC

CAT 42

DIAMOND CUT ROTARY BURRS

Tungsten Carbide

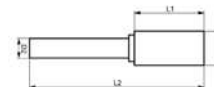

Art.	€	D1	L1	D2	L2
A02DC3	€ 3,75	ø2 mm	10 mm	3 mm	38 mm
A06DC6	€ 10,40	ø6 mm	16 mm	6 mm	61 mm
A08DC6	€ 11,70	ø8 mm	20 mm	6 mm	65 mm
A10DC6	€ 14,60	ø10 mm	20 mm	6 mm	65 mm
A12DC6	€ 21,30	ø12 mm	25 mm	6 mm	70 mm
A16DC6	€ 33,30	ø16 mm	25 mm	6 mm	70 mm

A12AL6

CAT 42 € 24,60

ROTARY BURRS FOR ALUMINIUM

Tungsten Carbide

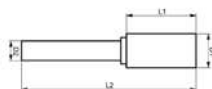

D1	ø12 mm
L1	25 mm
D2	6 mm
L2	70 mm

BxSC

CAT 42

SINGLE CUT ROTARY BURRS

Tungsten Carbide

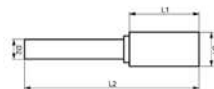

Art.	€	D1	L1	D2	L2
B02SC3	€ 3,75	ø2 mm	10 mm	3 mm	38 mm
B03SC3	€ 3,75	ø3 mm	13 mm	3 mm	38 mm
B04SC3	€ 7,90	ø4 mm	13 mm	3 mm	41 mm
B04SC6	€ 8,30	ø4 mm	13 mm	6 mm	58 mm
B06SC6	€ 10,40	ø6 mm	16 mm	6 mm	61 mm
B08SC6	€ 11,70	ø8 mm	20 mm	6 mm	65 mm
B10SC6	€ 14,60	ø10 mm	20 mm	6 mm	65 mm
B12SC6	€ 21,30	ø12 mm	25 mm	6 mm	70 mm
B16SC6	€ 33,30	ø16 mm	25 mm	6 mm	70 mm

BxDC

CAT 42

DIAMOND CUT ROTARY BURRS

Tungsten Carbide

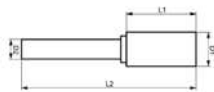

Art.	€	D1	L1	D2	L2
B02DC3	€ 3,75	ø2 mm	10 mm	3 mm	38 mm
B03DC3	€ 3,75	ø3 mm	13 mm	3 mm	38 mm
B04DC3	€ 7,90	ø4 mm	13 mm	3 mm	41 mm
B04DC6	€ 8,30	ø4 mm	13 mm	6 mm	58 mm
B06DC6	€ 10,40	ø6 mm	16 mm	6 mm	61 mm
B08DC6	€ 11,70	ø8 mm	20 mm	6 mm	65 mm
B10DC6	€ 14,60	ø10 mm	20 mm	6 mm	65 mm
B12DC6	€ 21,30	ø12 mm	25 mm	6 mm	70 mm
B16DC6	€ 33,30	ø16 mm	25 mm	6 mm	70 mm
B19DC6	€ 48,30	ø19 mm	25 mm	6 mm	70 mm
B22DC6	€ 74,20	ø22 mm	25 mm	6 mm	70 mm
B25DC6	€ 85,80	ø25 mm	25 mm	6 mm	70 mm



BxAL

CAT 42

ROTARY BURRS FOR ALUMINIUM

Tungsten Carbide

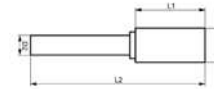

Art.	€	D1	L1	D2	L2
B06AL6	€ 12,10	ø6 mm	16 mm	6 mm	61 mm
B08AL6	€ 13,80	ø8 mm	20 mm	6 mm	65 mm
B10AL6	€ 16,70	ø10 mm	20 mm	6 mm	65 mm
B12AL6	€ 24,20	ø12 mm	25 mm	6 mm	70 mm



BxSCxL

CAT 42

SINGLE CUT LONG ROTARY BURRS

Tungsten Carbide

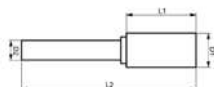

Art.	€	D1	L1	D2	L2
B02SC3L	€ 4,92	ø2 mm	10 mm	3 mm	65 mm
B03SC3L	€ 4,92	ø3 mm	13 mm	3 mm	65 mm
B08SC6L	€ 15,00	ø8 mm	20 mm	6 mm	120 mm
B10SC6L	€ 18,80	ø10 mm	20 mm	6 mm	120 mm
B12SC6L	€ 22,90	ø12 mm	25 mm	6 mm	120 mm



BxDCxL

CAT 42

CARBIDE ROTARY BURRS

Tungsten Carbide

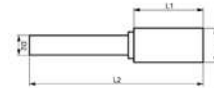

Art.	€	D1	L1	D2	L2
B02DC3L	€ 4,92	ø2 mm	10 mm	3 mm	65 mm
B03DC3L	€ 4,92	ø3 mm	13 mm	3 mm	65 mm
B08DC6L	€ 15,00	ø8 mm	20 mm	6 mm	120 mm
B10DC6L	€ 18,80	ø10 mm	20 mm	6 mm	120 mm
B12DC6L	€ 22,90	ø12 mm	25 mm	6 mm	120 mm



CxSC

CAT 42

SINGLE CUT ROTARY BURRS

Tungsten Carbide

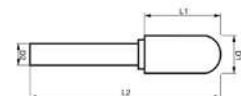

Art.	€	D1	L1	D2	L2
C02SC3	€ 3,75	ø2 mm	10 mm	3 mm	38 mm
C03SC3	€ 3,75	ø3 mm	13 mm	3 mm	38 mm
C04SC3	€ 7,90	ø4 mm	13 mm	3 mm	58 mm
C04SC6	€ 8,30	ø4 mm	13 mm	6 mm	58 mm
C06SC6	€ 10,40	ø6 mm	16 mm	6 mm	61 mm
C08SC6	€ 11,70	ø8 mm	20 mm	6 mm	65 mm
C10SC6	€ 14,60	ø10 mm	20 mm	6 mm	65 mm
C12SC6	€ 21,30	ø12 mm	25 mm	6 mm	70 mm
C16SC6	€ 33,30	ø16 mm	25 mm	6 mm	70 mm



CxDC

CAT 42

DIAMOND CUT ROTARY BURRS

Tungsten Carbide

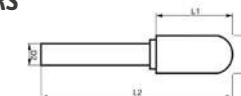

Art.	€	D1	L1	D2	L2
C02DC3	€ 3,75	ø2 mm	10 mm	3 mm	38 mm
C03DC3	€ 3,75	ø3 mm	13 mm	3 mm	38 mm
C04DC3	€ 7,90	ø4 mm	13 mm	3 mm	38 mm
C04DC6	€ 8,30	ø4 mm	13 mm	6 mm	38 mm
C06DC6	€ 10,40	ø6 mm	16 mm	6 mm	61 mm
C08DC6	€ 11,70	ø8 mm	20 mm	6 mm	65 mm
C10DC6	€ 14,60	ø10 mm	20 mm	6 mm	65 mm
C12DC6	€ 21,30	ø12 mm	25 mm	6 mm	70 mm
C16DC6	€ 33,30	ø16 mm	25 mm	6 mm	70 mm
C19DC6	€ 48,30	ø19 mm	25 mm	6 mm	70 mm
C22DC6	€ 74,20	ø22 mm	25 mm	6 mm	70 mm
C25DC6	€ 85,80	ø25 mm	25 mm	6 mm	70 mm



CxAL

CAT 42

ROTARY BURRS FOR ALUMINIUM

Tungsten Carbide

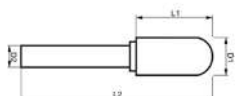

Art.	€	D1	L1	D2	L2
C06AL6	€ 11,70	ø6 mm	16 mm	6 mm	61 mm
C08AL6	€ 13,80	ø8 mm	20 mm	6 mm	65 mm
C10AL6	€ 16,70	ø10 mm	20 mm	6 mm	65 mm
C12AL6	€ 24,20	ø12 mm	25 mm	6 mm	70 mm



DxSC

CAT 42

SINGLE CUT ROTARY BURRS

Tungsten Carbide



Art.	€	D1	L1	D2	L2
D03SC3	€ 3,75	ø3 mm	2.7 mm	3 mm	38 mm
D04SC6	€ 8,30	ø4 mm	3.6 mm	6 mm	38 mm
D06SC6	€ 8,30	ø6 mm	5.4 mm	6 mm	50 mm
D08SC6	€ 9,20	ø8 mm	7.2 mm	6 mm	52 mm
D10SC6	€ 12,10	ø10 mm	9 mm	6 mm	54 mm
D12SC6	€ 17,10	ø12 mm	10.8 mm	6 mm	56 mm
D16SC6	€ 23,30	ø16 mm	14.4 mm	6 mm	60 mm



DxDC

CAT 42

DIAMOND CUT ROTARY BURRS

Tungsten Carbide



Art.	€	D1	L1	D2	L2
D03DC3	€ 3,75	ø3 mm	2.7 mm	3 mm	38 mm
D04DC6	€ 8,30	ø4 mm	3.6 mm	6 mm	38 mm
D06DC6	€ 8,30	ø6 mm	5.4 mm	6 mm	50 mm
D08DC6	€ 9,20	ø8 mm	7.2 mm	6 mm	52 mm
D10DC6	€ 12,10	ø10 mm	9 mm	6 mm	54 mm
D12DC6	€ 17,10	ø12 mm	10.8 mm	6 mm	56 mm
D16DC6	€ 23,30	ø16 mm	14.4 mm	6 mm	60 mm
D19DC6	€ 48,30	ø19 mm	17.4 mm	6 mm	64 mm

DxAL

CAT 42

ROTARY BURRS FOR ALUMINIUM

Tungsten Carbide

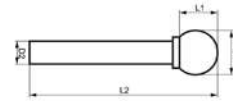

Art.	€	D1	L1	D2	L2
D06AL6	€ 9,60	ø6 mm	5.4 mm	6 mm	50 mm
D08AL6	€ 10,00	ø8 mm	7.2 mm	6 mm	52 mm
D10AL6	€ 14,20	ø10 mm	9 mm	6 mm	54 mm

ExSC

CAT 42

SINGLE CUT ROTARY BURRS

Tungsten Carbide

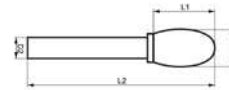

Art.	€	D1	L1	D2	L2
E08SC6	€ 11,70	ø8 mm	13 mm	6 mm	58 mm
E10SC6	€ 14,60	ø10 mm	16 mm	6 mm	61 mm
E12SC6	€ 21,30	ø12 mm	20 mm	6 mm	65 mm
E16SC6	€ 33,30	ø16 mm	25 mm	6 mm	70 mm

ExDC

CAT 42

DIAMOND CUT ROTARY BURRS

Tungsten Carbide

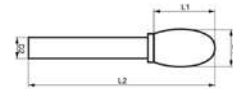

Art.	€	D1	L1	D2	L2
E08DC6	€ 11,70	ø8 mm	13 mm	6 mm	58 mm
E10DC6	€ 14,60	ø10 mm	16 mm	6 mm	61 mm
E12DC6	€ 21,30	ø12 mm	20 mm	6 mm	65 mm
E16DC6	€ 33,30	ø16 mm	25 mm	6 mm	70 mm

ExAL

CAT 42

ROTARY BURRS FOR ALUMINIUM

Tungsten Carbide

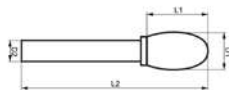

Art.	€	D1	L1	D2	L2
E10AL6	€ 16,70	10 mm	16 mm	6 mm	61 mm
E12AL6	€ 24,60	12 mm	20 mm	6 mm	65 mm

FxSC

CAT 42

SINGLE CUT ROTARY BURRS

Tungsten Carbide

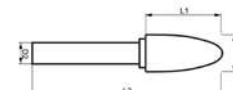

Art.	€	D1	D2	L1	L2
F03SC3	€ 3,75	ø3 mm	13 mm	3 mm	38 mm
F06SC6	€ 10,40	ø6 mm	18 mm	6 mm	63 mm
F08SC6	€ 11,70	ø8 mm	20 mm	6 mm	65 mm
F10SC6	€ 14,60	ø10 mm	20 mm	6 mm	65 mm
F12SC6	€ 21,30	ø12 mm	25 mm	6 mm	70 mm

FxDC

CAT 42

DIAMOND CUT ROTARY BURRS

Tungsten Carbide

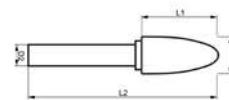

Art.	€	D1	D2	L1	L2
F03DC3	€ 3,75	ø3 mm	13 mm	3 mm	38 mm
F06DC6	€ 10,40	ø6 mm	18 mm	6 mm	63 mm
F08DC6	€ 11,70	ø8 mm	20 mm	6 mm	65 mm
F10DC6	€ 14,60	ø10 mm	20 mm	6 mm	65 mm
F12DC6	€ 21,30	ø12 mm	25 mm	6 mm	70 mm
F16DC6	€ 33,30	ø16 mm	25 mm	6 mm	70 mm
F19DC6	€ 48,30	ø19 mm	25 mm	6 mm	70 mm

FxAL

CAT 42

ROTARY BURRS FOR ALUMINIUM

Tungsten Carbide

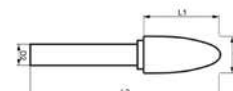

Art.	€	D1	L1	D2	L2
F10AL6	€ 16,70	ø10 mm	20 mm	6 mm	65 mm
F12AL6	€ 24,60	ø12 mm	25 mm	6 mm	70 mm

GxSC

CAT 42

SINGLE CUT ROTARY BURRS

Tungsten Carbide

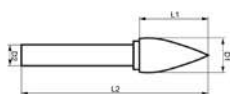

Art.	€	D1	L1	D2	L2
G03SC3	€ 3,75	ø3 mm	13 mm	3 mm	38 mm
G06SC6	€ 10,40	ø6 mm	18 mm	6 mm	65 mm
G10SC6	€ 14,60	ø10 mm	20 mm	6 mm	65 mm
G12SC6	€ 21,30	ø12 mm	25 mm	6 mm	70 mm

GxAL

CAT 42

ROTARY BURRS FOR ALUMINIUM

Tungsten Carbide

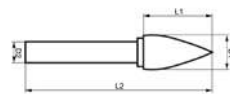

Art.	€	D1	L1	D2	L2
G10AL6	€ 16,70	ø10 mm	20 mm	6 mm	65 mm
G12AL6	€ 24,60	ø12 mm	25 mm	6 mm	70 mm

HxDC

CAT 42

DIAMOND CUT ROTARY BURRS

Tungsten Carbide

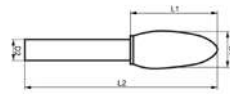

Art.	€	D1	D2	L1	L2
H06DC6	€ 10,40	ø6 mm	16 mm	6 mm	61 mm
H08DC6	€ 11,30	ø8 mm	20 mm	6 mm	65 mm
H10DC6	€ 12,90	ø10 mm	25 mm	6 mm	70 mm
H12DC6	€ 24,20	ø12 mm	32 mm	6 mm	77 mm

LxSC

CAT 42

SINGLE CUT ROTARY BURRS

Tungsten Carbide

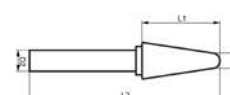

Art.	€	D1	L1	D2	L2
L03SC3	€ 3,75	ø3 mm	13 mm	3 mm	38 mm
L06SC6	€ 10,40	ø6 mm	16 mm	6 mm	61 mm

GxDC

CAT 42

DIAMOND CUT ROTARY BURRS

Tungsten Carbide

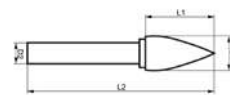

Art.	€	D1	L1	D2	L2
G03DC3	€ 3,75	ø3 mm	13 mm	3 mm	38 mm
G06DC6	€ 10,40	ø6 mm	18 mm	6 mm	65 mm
G10DC6	€ 14,60	ø10 mm	20 mm	6 mm	65 mm
G12DC6	€ 21,30	ø12 mm	25 mm	6 mm	70 mm
G16DC6	€ 33,30	ø16 mm	25 mm	6 mm	70 mm
G19DC6	€ 48,30	ø19 mm	25 mm	6 mm	70 mm

HxSC

CAT 42

SINGLE CUT ROTARY BURRS

Tungsten Carbide

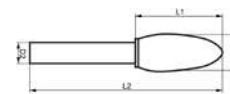

Art.	€	D1	L1	D2	L2
H08SC6	€ 11,30	ø8 mm	20 mm	6 mm	65 mm
H10SC6	€ 12,90	ø10 mm	25 mm	6 mm	70 mm
H12SC6	€ 24,20	ø12 mm	32 mm	6 mm	77 mm

HxAL

CAT 42

ROTARY BURRS FOR ALUMINIUM

Tungsten Carbide

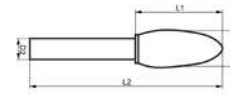

Art.	€	D1	D2	L1	L2
H08AL6	€ 12,90	ø8 mm	20 mm	6 mm	65 mm
H10AL6	€ 16,70	ø10 mm	25 mm	6 mm	70 mm
H12AL6	€ 28,30	ø12 mm	32 mm	6 mm	77 mm

LxDC

CAT 42

DIAMOND CUT ROTARY BURRS

Tungsten Carbide

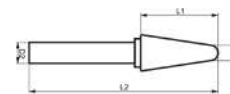

Art.	€	D1	L1	D2	L2
L03DC3	€ 3,75	ø3 mm	13 mm	3 mm	38 mm
L06DC6	€ 10,40	ø6 mm	16 mm	6 mm	61 mm
L08DC6	€ 12,50	ø8 mm	22 mm	6 mm	65 mm
L10DC6	€ 15,80	ø10 mm	25 mm	6 mm	70 mm
L12DC6	€ 21,30	ø12 mm	25 mm	6 mm	70 mm

L10AL6

CAT 42

ROTARY BURRS FOR ALUMINIUM

Tungsten Carbide

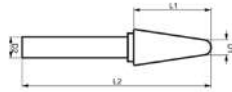

D1	ø10 mm
L1	25 mm
D2	6 mm
L2	70 mm

MxSC

CAT 42

SINGLE CUT ROTARY BURRS

Tungsten Carbide

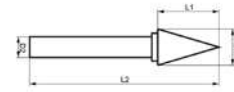

Art.	€	D1	L1	D2	L2
M08SC6	€ 11,70	ø8 mm	20 mm	6 mm	65 mm
M10SC6	€ 15,00	ø10 mm	20 mm	6 mm	65 mm
M12SC6	€ 21,30	ø12 mm	25 mm	6 mm	70 mm

MxDC

CAT 42

DIAMOND CUT ROTARY BURRS

Tungsten Carbide

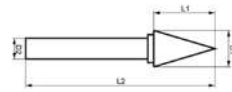

Art.	€	D1	L1	D2	L2
M03DC3	€ 3,75	ø3 mm	11 mm	3 mm	38 mm
M03DC6	€ 7,00	ø3 mm	11 mm	6 mm	38 mm
M06DC6	€ 10,40	ø6 mm	18 mm	6 mm	60 mm
M08DC6	€ 11,70	ø8 mm	20 mm	6 mm	65 mm
M10DC6	€ 15,00	ø10 mm	20 mm	6 mm	65 mm
M12DC6	€ 21,30	ø12 mm	25 mm	6 mm	70 mm
M16DC6	€ 33,30	ø16 mm	25 mm	6 mm	70 mm

M10AL6

CAT 42

ROTARY BURRS FOR ALUMINIUM

Tungsten Carbide

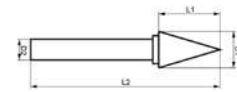

D1	ø10 mm
L1	20 mm
D2	6 mm
L2	65 mm

NxSC

CAT 42

SINGLE CUT ROTARY BURRS

Tungsten Carbide



Art.	€	D1	L1	D2	L2
N12SC6	€ 21,30	ø12 mm	13 mm	6 mm	58 mm
N16SC6	€ 30,00	ø16 mm	16 mm	6 mm	58 mm

N12DC6

CAT 42

DIAMOND CUT ROTARY BURRS

Tungsten Carbide



D1	ø12 mm
L1	13 mm
D2	6 mm
L2	58 mm

JxSC

CAT 42

SINGLE CUT ROTARY BURRS

Tungsten Carbide



Art.	€	D1	L1	D2	L2
J03SC3	€ 3,75	ø3 mm	2.5 mm	3 mm	38 mm
J06SC6	€ 10,40	ø6 mm	5.2 mm	6 mm	54 mm
J10SC6	€ 14,60	ø10 mm	8 mm	6 mm	58 mm
J16SC6	€ 33,30	ø16 mm	13 mm	6 mm	62 mm

JxDC

CAT 42

DIAMOND CUT ROTARY BURRS

Tungsten Carbide



Art.	€	D1	L1	D2	L2
J03DC3	€ 3,75	ø3 mm	2.5 mm	3 mm	38 mm
J06DC6	€ 10,40	ø6 mm	5.2 mm	6 mm	54 mm
J10DC6	€ 14,60	ø10 mm	8 mm	6 mm	58 mm
J16DC6	€ 33,30	ø16 mm	13 mm	6 mm	62 mm



KxSC

CAT 42

SINGLE CUT ROTARY BURRS

Tungsten Carbide

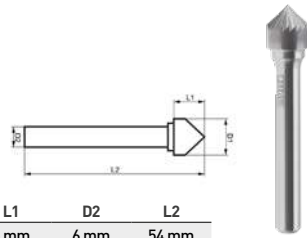

Art.	€	D1	L1	D2	L2
K10SC6	€ 14,60	ø10 mm	5 mm	6 mm	54 mm
K16SC6	€ 30,00	ø16 mm	8 mm	6 mm	58 mm

KxDC

CAT 42

DIAMOND CUT ROTARY BURRS

Tungsten Carbide

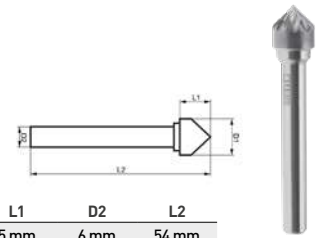

Art.	€	D1	L1	D2	L2
K10DC6	€ 14,60	ø10 mm	5 mm	6 mm	54 mm
K16DC6	€ 30,00	ø16 mm	8 mm	6 mm	58 mm

F008DC

CAT 42

HARD METAL ROTARY BURR SET WITH DIAMOND CUT



5 Tungsten Carbide

Sizes	10 x 20 mm
Type	B, C, D, G, M
Shank	6 mm

F008SC

CAT 42

HARD METAL ROTARY BURR SET WITH SINGLE CUT



5 Tungsten Carbide

Sizes	10 x 20 mm
Type	B, C, D, G, M
Shank	6 mm

F008-

CARBIDE ROTARY FILE SET

CROSS CUT



8 Pcs Tungsten Carbide

Art.	€	Shank
F008/3	€ 50,50	Ø 3 mm
F008/6	€ 85,50	Ø 6 mm



MFDxZ

MINI FLAP DISC

FAST LOCK. LONG LIFE, DEBURRING AND BLENDING SMALL AREAS, GRINDING EDGES.

PACKING OF 10* PIECES



Zirconia

Art.	€	Diameter ø	Grit	rpm max
MFD050/040Z	€ 1,98	50 mm	40	25000
MFD050/060Z	€ 1,98	50 mm	60	25000
MFD050/080Z	€ 1,98	50 mm	80	25000
MFD050/120Z	€ 1,98	50 mm	120	25000
MFD075/040Z	€ 3,35	75 mm	40	20000
MFD075/060Z	€ 3,35	75 mm	60	20000
MFD075/080Z	€ 3,35	75 mm	80	20000
MFD075/120Z	€ 3,35	75 mm	120	20000

MCDxZ

MINI CUP FLAP DISC

FAST LOCK. SUITED FOR CONTOURED SURFACES. MORE FLEXIBLE AND CONFORMABLE COMPARED TO MINI DISCS.

PACKING OF 10* PIECES



Zirconia

Art.	€	Diameter ø	Grit	rpm max
MCD050/040Z	€ 2,95	50 mm	40	25000
MCD050/060Z	€ 2,95	50 mm	60	25000
MCD050/080Z	€ 2,95	50 mm	80	25000
MCD050/120Z	€ 2,95	50 mm	120	25000

MSCx

CAT 42

FAST LOCK SURFACE CONDITIONING



Art.	€	Diameter ø	Grit	rpm max
MSC050/C	€ 1,75	50 mm	Coarse	25000
MSC050/M	€ 1,75	50 mm	Medium	25000
MSC050/VF	€ 1,67	50 mm	Very Fine	25000
MSC075/C	€ 2,22	75 mm	Coarse	20000
MSC075/M	€ 2,22	75 mm	Medium	20000
MSC075/VF	€ 2,22	75 mm	Very Fine	20000

MFDxZC

CERAMIC MINI FLAP DISC

FAST LOCK. CERAMIC ABRASIVE IS HARD AND SELF SHARPENING, WITH FASTER STOCK REMOVAL AND MUCH LONGER LIFE COMPARED TO ZIRCONIA. IDEAL TO WORK ON EDGES OR WITH HEAVY PRESSURE.

PACKING OF 10* PIECES

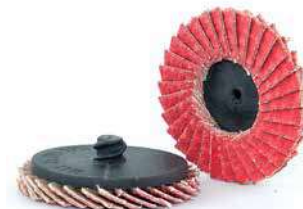

Ceramic

Art.	€	Diameter ø	Grit	rpm max
MFD050/040ZC	€ 2,15	50 mm	40	25000
MFD050/060ZC	€ 2,15	50 mm	60	25000
MFD050/080ZC	€ 2,15	50 mm	80	25000

MDAxZT

CAT 42

FAST LOCK ZIRCONIA TOP SIZE

PACKING OF 25* PIECES



Zirconia

Art.	€	Diameter ø	Grit	rpm max
MDA050/036ZT	€ 0,68	50 mm	36	25000
MDA050/060ZT	€ 0,67	50 mm	60	25000
MDA050/080ZT	€ 0,67	50 mm	80	25000
MDA050/120ZT	€ 0,67	50 mm	120	25000
MDA075/036ZT	€ 1,13	75 mm	36	20000
MDA075/060ZT	€ 1,07	75 mm	60	20000
MDA075/080ZT	€ 1,07	75 mm	80	20000
MDA075/120ZT	€ 1,07	75 mm	120	20000

MDUx

CAT 42

FAST LOCK UNITIZED



Art.	€	Diameter ø	Grit	rpm max
MDU075/2SF	€ 9,30	75 mm	2SF	20000
MDU075/6SF	€ 10,60	75 mm	6SF	20000
MDU075/6AM	€ 12,50	75 mm	6AM	20000

MDFx

CAT 42

FAST LOCK FELTRO

PACKING OF 10* PIECES



Art.	€	Diameter ø	rpm max
MDF050	€ 2,40	50 mm	25000
MDF075	€ 3,30	75 mm	20000

RMTx

MICRO FLAP WHEELS

PACKING OF 25* PIECES



Art.	€	Diameter ø	H	Shank	Grit	rpm max
RMT1010/060	€ 2,22	10 mm	10 mm	3 mm	60	26000
RMT1010/080	€ 2,22	10 mm	10 mm	3 mm	80	26000
RMT1010/120	€ 2,22	10 mm	10 mm	3 mm	120	26000
RMT1515/060	€ 1,87	15 mm	15 mm	3 mm	60	26000
RMT1515/080	€ 1,87	15 mm	15 mm	3 mm	80	26000
RMT1515/120	€ 1,87	15 mm	15 mm	3 mm	120	26000

SGFx

RUBBER HOLDER



Plastic bag

Art.	€	Diameter ø	Shank	rpm max
SGF050/06	€ 7,80	50 mm	6 mm	30000
SGF075/06	€ 9,00	75 mm	6 mm	28000

SFFx

RUBBER HOLDER

FIXING M14



Plastic bag

Art.	€	Diameter ø	Thread	rpm max
SFF050/M14	€ 11,80	50 mm	M14	30000
SFF075/M14	€ 13,30	75 mm	M14	28000

ADR3/6

€ 9,40

ADAPTER FROM SHAFT 3MM TO 6MM



RGTx

*CAT 42

ALUMINIUM OXIDE SHAFT-MOUNTED CLOTH WHEELS

PACKING OF 10* PIECES



Cloth: Aluminium oxide

Art.	€	Dimensions	Shank	Grit	rpm max	Art.	€	Dimensions	Shank	Grit	rpm max
RGT2010/40	€ 2,03	20 x 10 mm	6 mm	40	26000	RGT4015/60	€ 2,17	40 x 15 mm	6 mm	60	17100
RGT2010/60	€ 2,03	20 x 10 mm	6 mm	60	26000	RGT4015/80	€ 2,23	40 x 15 mm	6 mm	80	17100
RGT2010/80	€ 2,03	20 x 10 mm	6 mm	80	26000	RGT4015/120	€ 2,23	40 x 15 mm	6 mm	120	17100
RGT2010/120	€ 2,03	20 x 10 mm	6 mm	120	26000	RGT4020/40	€ 2,23	40 x 20 mm	6 mm	40	17100
RGT2015/40	€ 2,03	20 x 15 mm	6 mm	40	25000	RGT4020/60	€ 2,23	40 x 20 mm	6 mm	60	17100
RGT2015/60	€ 2,03	20 x 15 mm	6 mm	60	25000	RGT4020/80	€ 2,23	40 x 20 mm	6 mm	80	17100
RGT2015/80	€ 2,03	20 x 15 mm	6 mm	80	25000	RGT4020/120	€ 2,23	40 x 20 mm	6 mm	120	17100
RGT2015/120	€ 2,03	20 x 15 mm	6 mm	120	25000	RGT4030/40	€ 2,55	40 x 30 mm	6 mm	40	17100
RGT2515/60	€ 1,93	25 x 15 mm	6 mm	60	25000	RGT4030/60	€ 2,55	40 x 30 mm	6 mm	60	17100
RGT2515/80	€ 1,93	25 x 15 mm	6 mm	80	25000	RGT4030/80	€ 2,55	40 x 30 mm	6 mm	80	17100
RGT2515/120	€ 1,93	25 x 15 mm	6 mm	120	25000	RGT4030/120	€ 2,55	40 x 30 mm	6 mm	120	17100
RGT2525/40	€ 1,92	25 x 25 mm	6 mm	40	25000	RGT5020/40	€ 2,33	50 x 20 mm	6 mm	40	13700
RGT2525/60	€ 1,92	25 x 25 mm	6 mm	60	25000	RGT5020/60	€ 2,33	50 x 20 mm	6 mm	60	13700
RGT2525/80	€ 1,92	25 x 25 mm	6 mm	80	25000	RGT5020/80	€ 2,33	50 x 20 mm	6 mm	80	13700
RGT2525/120	€ 1,92	25 x 25 mm	6 mm	120	25000	RGT5020/120	€ 2,33	50 x 20 mm	6 mm	120	13700
RGT3010/40	€ 1,85	30 x 10 mm	6 mm	40	22900	RGT5030/40	€ 2,75	50 x 30 mm	6 mm	40	11400
RGT3010/60	€ 1,85	30 x 10 mm	6 mm	60	22900	RGT5030/60	€ 2,75	50 x 30 mm	6 mm	60	11400
RGT3010/80	€ 1,85	30 x 10 mm	6 mm	80	22900	RGT5030/80	€ 2,75	50 x 30 mm	6 mm	80	11400
RGT3010/120	€ 1,85	30 x 10 mm	6 mm	120	22900	RGT5030/120	€ 2,75	50 x 30 mm	6 mm	120	11400
RGT3015/40	€ 2,03	30 x 15 mm	6 mm	40	22900	RGT6020/40	€ 3,08	60 x 20 mm	6 mm	40	11400
RGT3015/60	€ 2,03	30 x 15 mm	6 mm	60	22900	RGT6020/60	€ 3,08	60 x 20 mm	6 mm	60	11400
RGT3015/80	€ 2,03	30 x 15 mm	6 mm	80	22900	RGT6020/80	€ 3,08	60 x 20 mm	6 mm	80	11400
RGT3015/120	€ 2,03	30 x 15 mm	6 mm	120	22900	RGT6020/120	€ 3,08	60 x 20 mm	6 mm	120	11400
RGT3020/40	€ 2,15	30 x 20 mm	6 mm	40	22900	RGT6030/40	€ 3,38	60 x 30 mm	6 mm	40	11400
RGT3020/60	€ 2,15	30 x 20 mm	6 mm	60	22900	RGT6030/60	€ 3,38	60 x 30 mm	6 mm	60	11400
RGT3020/80	€ 2,15	30 x 20 mm	6 mm	80	22900	RGT6030/80	€ 3,38	60 x 30 mm	6 mm	80	11400
RGT3020/120	€ 2,15	30 x 20 mm	6 mm	120	22900	RGT6030/120	€ 3,38	60 x 30 mm	6 mm	120	11400
RGT4015/40	€ 2,17	40 x 15 mm	6 mm	40	17100						

RGMx

MIXED NONWOVEN AND CLOTH WHEELS WITH SHAFT

MADE OF NONWOVEN FLAPS INTERSPERSED WITH ABRASIVE CLOTH FLAPS ARRANGED RADIALLY.

PACKING OF 10* PIECES



Cloth: Aluminium oxide

Art.	€	Dimensions	Shank	Cloth	Grit	Art.	€	Dimensions	Shank	Cloth	Grit
RGM030/20M	€ 4,08	30 x 20 mm	6 mm	A/O-M	60	RGM050/30VF	€ 5,40	50 x 30 mm	6 mm	A/O-VF	150
RGM030/20F	€ 4,08	30 x 20 mm	6 mm	A/O-F	100	RGM060/30M	€ 4,20	60 x 30 mm	6 mm	A/O-M	60
RGM030/20VF	€ 4,08	30 x 20 mm	6 mm	A/O-VF	150	RGM060/30F	€ 4,20	60 x 30 mm	6 mm	A/O-F	100
RGM040/20M	€ 4,87	40 x 20 mm	6 mm	A/O-M	60	RGM060/30VF	€ 4,20	60 x 30 mm	6 mm	A/O-VF	150
RGM040/20F	€ 4,87	40 x 20 mm	6 mm	A/O-F	100	RGM080/50M	€ 8,10	80 x 50 mm	6 mm	A/O-M	60
RGM040/20VF	€ 4,87	40 x 20 mm	6 mm	A/O-VF	150	RGM080/50F	€ 8,10	80 x 50 mm	6 mm	A/O-F	100
RGM050/30M	€ 5,40	50 x 30 mm	6 mm	A/O-M	60	RGM080/50VF	€ 8,10	80 x 50 mm	6 mm	A/O-VF	150
RGM050/30F	€ 5,40	50 x 30 mm	6 mm	A/O-F	100						

RGPx

NONWOVEN WHEELS WITH SHAFT

FLAPS ARRANGED RADIALY

PACKING OF 10* PIECES



Cloth: Aluminium oxide

Art.	€	Dimensions	Shank	Grit
RGPO30/20C	€ 3,54	30 x 20 mm	6 mm	COARSE
RGPO30/20M	€ 3,54	30 x 20 mm	6 mm	MEDIUM
RGPO30/20F	€ 3,54	30 x 20 mm	6 mm	FINE
RGPO30/20VF	€ 3,54	30 x 20 mm	6 mm	VERY FINE
RGPO40/20C	€ 3,78	40 x 20 mm	6 mm	COARSE
RGPO40/20M	€ 3,78	40 x 20 mm	6 mm	MEDIUM
RGPO40/20F	€ 3,78	40 x 20 mm	6 mm	FINE
RGPO40/20VF	€ 3,78	40 x 20 mm	6 mm	VERY FINE
RGPO50/30C	€ 4,79	50 x 30 mm	6 mm	COARSE
RGPO50/30M	€ 4,79	50 x 30 mm	6 mm	MEDIUM

Art.	€	Dimensions	Shank	Grit
RGPO50/30F	€ 4,79	50 x 30 mm	6 mm	FINE
RGPO50/30VF	€ 4,79	50 x 30 mm	6 mm	VERY FINE
RGPO60/30C	€ 4,97	60 x 30 mm	6 mm	COARSE
RGPO60/30M	€ 4,97	60 x 30 mm	6 mm	MEDIUM
RGPO60/30F	€ 4,97	60 x 30 mm	6 mm	FINE
RGPO60/30VF	€ 4,97	60 x 30 mm	6 mm	VERY FINE
RGPO80/50C	€ 7,70	80 x 50 mm	6 mm	COARSE
RGPO80/50M	€ 7,70	80 x 50 mm	6 mm	MEDIUM
RGPO80/50F	€ 7,70	80 x 50 mm	6 mm	FINE
RGPO80/50VF	€ 7,70	80 x 50 mm	6 mm	VERY FINE

RFTx

ALUMINIUM OXIDE CLOTH WHEELS WITH HOLE

THE WHEEL CAN BE CONFIGURED ON THE PROFILE OF THE WORKPIECE. LUBRICATING THE WHEEL WITH OIL OR FAT, IT IMPROVES THE DEGREE OF FINISH, THE DURATION OF THE WHEEL AND IS HELD ACTION DUSTPROOF.



Cloth: Aluminium oxide

Art.	€	Dimensions	Grit	rpm max
RFT165/25040	€ 19,00	165 x 25 x 54 mm	40	5200
RFT165/25060	€ 19,50	165 x 25 x 54 mm	60	5200
RFT165/25080	€ 19,70	165 x 25 x 54 mm	80	5200
RFT165/25120	€ 20,30	165 x 25 x 54 mm	120	5200
RFT165/25220	€ 25,70	165 x 25 x 54 mm	220	5200
RFT165/30040	€ 19,80	165 x 30 x 54 mm	40	5200
RFT165/30060	€ 32,00	165 x 30 x 54 mm	60	5200
RFT165/30080	€ 20,50	165 x 30 x 54 mm	80	5200
RFT165/30120	€ 21,30	165 x 30 x 54 mm	120	5200
RFT165/30220	€ 42,10	165 x 30 x 54 mm	220	5200
RFT165/50040	€ 37,60	165 x 50 x 54 mm	40	5200
RFT165/50060	€ 40,60	165 x 50 x 54 mm	60	5200
RFT165/50080	€ 41,40	165 x 50 x 54 mm	80	5200
RFT165/50120	€ 45,00	165 x 50 x 54 mm	120	5200

Art.	€	Dimensions	Grit	rpm max
RFT165/50220	€ 38,70	165 x 50 x 54 mm	220	5200
RFT165/50040A	€ 27,50	165 x 50 x 25 mm	40	5200
RFT165/50060A	€ 28,00	165 x 50 x 25 mm	60	5200
RFT165/50080A	€ 29,00	165 x 50 x 25 mm	80	5200
RFT165/50120A	€ 30,00	165 x 50 x 25 mm	120	5200
RFT165/50220A	€ 38,70	165 x 50 x 25 mm	220	5200
RFT200/50040	€ 32,70	200 x 50 x 54 mm	40	3800
RFT200/50060	€ 36,00	201 x 50 x 54 mm	60	3800
RFT200/50080	€ 37,30	202 x 50 x 54 mm	80	3800
RFT200/50120	€ 38,50	203 x 50 x 54 mm	120	3800
RFT250/50040	€ 62,20	204 x 50 x 100 mm	40	3400
RFT250/50060	€ 66,20	205 x 50 x 100 mm	60	3400
RFT250/50080	€ 107,00	250 x 50 x 100 mm	80	3400
RFT250/50120	€ 111,00	250 x 50 x 100 mm	120	3400

FRF54/20

CAT 42

PAIR OF FLANGES



Art.	€	Size	Hole
FRF54/20	€ 16,00	54 mm	20 mm
FRF54/25	€ 16,00	54 mm	25 mm

RLFx

THREADED BORE FLAP WHEEL

SUITED FOR ANGLE GRINDERS WITH M14 THREAD. REMOVE LIGHT WELD SEAMS ON ROUND AND IRREGULAR METAL SURFACES.



Art.	€	Size	Thread	Grit	rpm max
RLF115/040	€ 12,30	Ø 115 x 20 mm	M14	40	9000
RLF115/060	€ 12,30	Ø 115 x 20 mm	M14	60	9000
RLF115/080	€ 12,30	Ø 115 x 20 mm	M14	80	9000
RLF115/120	€ 12,30	Ø 115 x 20 mm	M14	120	9000
RLF125/040	€ 13,40	Ø 115 x 20 mm	M14	40	9000
RLF125/060	€ 13,40	Ø 125 X 20 mm	M14	60	9000
RLF125/080	€ 13,40	Ø 125 X 20 mm	M14	80	9000
RLF125/120	€ 13,40	Ø 125 X 20 mm	M14	120	9000

RFPx

NONWOVEN WHEELS WITH BORE

MADE OF NONWOVEN, FLAPS RADIALLY ARRANGED.



Cloth: Aluminium oxide

Art.	€	Dimensions	Grit
RFP165/50M	€ 15,20	165 x 50 x 55 mm	Medium
RFP165/50F	€ 15,20	165 x 50 x 55 mm	Fine
RFP165/50VF	€ 15,20	165 x 50 x 55 mm	Very Fine
RFP200/50M	€ 21,30	200 x 50 x 76 mm	Medium
RFP200/50F	€ 21,30	200 x 50 x 76 mm	Fine
RFP200/50VF	€ 21,30	200 x 50 x 76 mm	Very Fine

RLMx

MIXED NONWOVEN WHEELS



Art.	€	Dimensions	Cloth	Grit	Hole diameter
RLM100/060C	€ 17,00	110 x 100 mm	A/C	60	19 mm
RLM100/080M	€ 17,00	110 x 100 mm	A/M	80	19 mm
RLM100/150F	€ 17,00	110 x 100 mm	A/F	150	19 mm

RLTx

ABRASIVE CLOTH WHEELS



Art.	€	Dimensions	Grit	Hole diameter
RLT050/040	€ 10,80	100 x 50 mm	40	19 mm
RLT050/060	€ 10,80	100 x 50 mm	60	19 mm
RLT050/080	€ 11,70	100 x 50 mm	80	19 mm
RLT050/120	€ 11,70	100 x 50 mm	120	19 mm
RLT100/040	€ 20,80	100 x 100 mm	40	19 mm
RLT100/060	€ 20,80	100 x 100 mm	60	19 mm
RLT100/080	€ 21,70	100 x 100 mm	80	19 mm
RLT100/120	€ 21,70	100 x 100 mm	120	19 mm

RLPx

NONWOVEN WHEELS



Art.	€	Dimensions	Grit	Hole diameter
RLP100/C	€ 15,00	110 x 100 mm	A/O-C	19 mm
RLP100/M	€ 14,20	110 x 100 mm	A/O-M	19 mm
RLP100/F	€ 14,20	110 x 100 mm	A/O-F	19 mm
RLP100/VF	€ 14,20	110 x 100 mm	A/O-VF	19 mm



NAS100/040Z

CAT 42

ZIRCONIA CLOTH BELTS



Zirconia

Art.	€	Dimensions	Grit
NAS100/040Z	€ 2,47	90 x 100 mm	40
NAS100/060Z	€ 2,47	90 x 100 mm	60
NAS100/080Z	€ 2,47	90 x 100 mm	80
NAS100/120Z	€ 2,47	90 x 100 mm	120

NAS100/040C

CAT 42

CERAMIC BELTS



Ceramic

Art.	€	Dimensions	Grit
NAS100/040C	€ 4,97	90 x 100 mm	40
NAS100/060C	€ 4,50	90 x 100 mm	60
NAS100/080C	€ 4,28	90 x 100 mm	80
NAS100/120C	€ 3,88	90 x 100 mm	120

SCS100/C

CAT 42

SURFACE CONDITIONING BELTS



Surface conditioning

Art.	€	Dimensions	Grit
SCS100/C	€ 12,80	90 x 100 mm	Coarse
SCS100/M	€ 12,10	90 x 100 mm	Medium
SCS100/VF	€ 12,10	90 x 100 mm	Very fine

NAS100/180A

CAT 42

ALUMINIUM OXIDE CLOTH BELTS



Aluminium oxide

Art.	€	Dimensions	Grit
NAS100/180A	€ 2,23	90 x 100 mm	180
NAS100/240A	€ 2,23	90 x 100 mm	240

NAT100/A006

CAT 42

TRIZACT BELTS



Trizact

Art.	€	Dimensions	Grit
NAT100/A006	€ 8,00	90 x 100 mm	A6
NAT100/A016	€ 8,00	90 x 100 mm	A16
NAT100/A030	€ 8,00	90 x 100 mm	A30
NAT100/A045	€ 8,00	90 x 100 mm	A45
NAT100/A065	€ 8,00	90 x 100 mm	A65
NAT100/A100	€ 8,00	90 x 100 mm	A100
NAT100/A160	€ 8,00	90 x 100 mm	A160

RPW090

CAT 42 € 84,50

RUBBER PNEUMATIC WHEEL



Dimensions	90 x 90 mm
Hole	19.1 mm
rpm max	6000



ERW100

CAT 42 € 71,00

CENTRIFUGAL EXPANDING WHEEL



Dimensions	90 x 100 mm
Hole	19.1 - 35 mm
rpm max	6000

SWS100

CAT 42 € 77,20

BRASS STEEL WIRE WHEELS



Steel

Dimensions	100 x 100 mm
Hole	19.1 mm
Wire	0.3 mm
rpm max	6800

SWS100/M

CAT 42 € 89,10

BRASS STEEL WIRE WHEELS

SUITABLE FOR MAKITA MACHINES



Steel

Dimensions	100 x 100 mm
Hole	13 mm
Wire	0.3 mm
rpm max	6800

NWS100

CAT 42 € 133,00

ABRASIVE NYLON WIRE WHEELS



Nylon

Dimensions	100 x 100 mm
Hole	19.1 mm
Grit	80
rpm max	6800

NWS100/M

CAT 42 € 143,00

ABRASIVE NYLON WIRE WHEELS

SUITABLE FOR MAKITA MACHINES



Nylon

Dimensions	100 x 100 mm
Hole	13 mm
Grit	80
rpm max	6800



SRFx

*CAT 42

CIRCULAR BRUSHES

MEDIUM TO HEAVY BRUSH APPLICATIONS: LONG LIFE, AGGRESSIVE, VERY RESISTANT.

Box

Art.	€	Dimensions	Hole	Wire	Material	rpm max
SRF125/25	€ 5,80	Ø 125 x 20 mm	16, 12,7 mm	0,3 mm	Steel	6000
SRF150/25	€ 7,00	Ø 150 x 32 mm	25, 22, 20, 16, 12,7 mm	0,3 mm	Steel	6000
SRF175/25	€ 8,00	Ø 175 x 32 mm	25, 22, 20, 16 mm	0,3 mm	Steel	6000
SRF200/25	€ 10,00	Ø 200 x 32 mm	25, 22, 20, 16 mm	0,3 mm	Steel	4500
SRF250/25	€ 19,20	Ø 250 x 32 mm	25, 22, 20, 16 mm	0,3 mm	Steel	3000
SRF125/25I	€ 10,30	Ø 125 x 20 mm	16, 12,7 mm	0,3 mm	Stainless steel	6000
SRF150/25I	€ 12,70	Ø 150 x 32 mm	25, 22, 20, 16, 12,7 mm	0,3 mm	Stainless steel	6000
SRF175/25I	€ 15,20	Ø 175 x 32 mm	25, 22, 20, 16 mm	0,3 mm	Stainless steel	6000
SRF200/25I	€ 18,60	Ø 200 x 32 mm	25, 22, 20, 16 mm	0,3 mm	Stainless steel	4500
SRF250/25I	€ 28,50	Ø 250 x 32 mm	25, 22, 20, 16 mm	0,3 mm	Stainless steel	3000



STFx

CUP BRUSHES

SUITED FOR ANGLE GRINDERS. PAINT AND PRIMER REMOVAL, ROUGHING, LIGHT RUST REMOVAL.

Box

Art.	€	Diameter Ø	Thread	Wire	Material	rpm max
STF060	€ 2,85	60 mm	M14	0,3 mm	Steel	12500
STF080	€ 3,38	80 mm	M14	0,3 mm	Steel	11000
STF100	€ 4,95	100 mm	M14	0,3 mm	Steel	8500
STF120	€ 8,80	120 mm	M14	0,3 mm	Steel	6500
STF060I	€ 5,00	60 mm	M14	0,3 mm	Stainless steel	12500
STF080I	€ 6,30	80 mm	M14	0,3 mm	Stainless steel	11000
STF100I	€ 8,80	100 mm	M14	0,3 mm	Stainless steel	8500
STF120I	€ 13,00	120 mm	M14	0,3 mm	Stainless steel	6500



SCFx

BEVEL BRUSHES

SUITED FOR ANGLE GRINDERS.

Box

Art.	€	Thread	Wire	Material	rpm max	Diameter Ø
SCF090	€ 3,30	M14	0,3 mm	Steel	125000	90 mm
SCF120	€ 4,45	M14	0,3 mm	Steel	125000	120 mm
SCF150	€ 8,70	M14	0,3 mm	Steel	6500	150 mm
SCF090I	€ 4,95	M14	0,3 mm	Stainless steel	125000	90 mm
SCF120I	€ 6,70	M14	0,3 mm	Stainless steel	12500	120 mm
SCF150I	€ 13,00	M14	0,3 mm	Stainless steel	6000	150 mm



SRRx

TWISTED KNOTS CIRCULAR BRUSHES

SUITED TO CLEAN WELDS AND TO REMOVE PAINT, RUST, ENCRUSTATIONS AND BURRS. HIGH OPERATING SPEED.



Steel Box

Art.	€	Diameter Ø	Hole	Wire	rpm max
SRR100	€ 5,10	100 mm	22 mm	0,5 mm	12500
SRR150	€ 10,00	150 mm	22 mm	0,5 mm	9000
SRR200	€ 14,30	200 mm	22 mm	0,5 mm	6000

SRRx-M14

TWISTED KNOTS CIRCULAR BRUSHES

SUITED TO CLEAN WELDS AND TO REMOVE PAINT, RUST, ENCRUSTATIONS AND BURRS. HIGH OPERATING SPEED.



Steel Box

Art.	€	Diameter Ø	Thread	Wire	rpm max
SRR100/M14	€ 5,00	100 mm	M14	0,5 mm	12500
SRR115/M14	€ 6,20	115 mm	M14	0,5 mm	12500
SRR125/M14	€ 7,40	125 mm	M14	0,5 mm	11000

STRx

*CAT 42

TWISTED KNOTS CUP BRUSHES

SUITED TO REMOVE CARBON, RUST, PAINT AND OTHER CONTAMINATIONS

Steel  Box 

Art.	€	Diameter ø	Thread	Wire	Material	rpm max
STR065	€ 3,60	65 mm	M14	0,5 mm	Steel	12500
STR075	€ 6,50	75 mm	M14	0,5 mm	Steel	8500
STR080	€ 7,60	80 mm	M14	0,5 mm	Steel	8500
STR100	€ 10,00	100 mm	M14	0,5 mm	Steel	8500
STR120	€ 13,00	120 mm	M14	0,5 mm	Steel	6500
STR065I	€ 8,10	65 mm	M 14	0,5 mm	Stainless steel	12500
STR075I	€ 10,10	75 mm	M 14	0,5 mm	Stainless steel	8500
STR080I	€ 13,50	80 mm	M 14	0,5 mm	Stainless steel	8500
STR100I	€ 15,80	100 mm	M 14	0,5 mm	Stainless steel	8500
STR120I	€ 20,40	120 mm	M 14	0,5 mm	Stainless steel	6500



SCRx

TWISTED KNOTS BEVEL BRUSHES

SUITED TO REMOVE CARBON, RUST, PAINT AND OTHER CONTAMINATIONS. TAPERED BRUSH SHAPED TO REACH ANGLES.

Art.	€	Diameter ø	Thread	Wire	Material	rpm max
SCR100	€ 5,40	100 mm	M14	0,5 mm	Steel	12500
SCR120	€ 7,60	120 mm	M14	0,5 mm	Steel	12500
SCR100I	€ 8,10	100 mm	M14	0,5 mm	Stainless steel	12500
SCR120I	€ 11,30	120 mm	M14	0,5 mm	Stainless steel	12500



SRGx

CIRCULAR BRUSHES WITH SHAFT

CLEANING OF LIGHT RUST, PAINT, PRIMER.

PACKING OF 25* PIECES UNTIL Ø 70 MM, PACKING OF 10* PIECES FROM Ø 80 MM

Art.	€	Diameter ø	Thickness	Shank	Wire	Material	rpm max
SRG030/05	€ 0,80	30 mm	5 mm	6 mm	0,3 mm	Steel	4500
SRG040/05	€ 0,88	40 mm	5 mm	6 mm	0,3 mm	Steel	4500
SRG050/06	€ 1,07	50 mm	6 mm	6 mm	0,3 mm	Steel	4500
SRG060/06	€ 1,23	60 mm	6 mm	6 mm	0,3 mm	Steel	4500
SRG070/08	€ 1,44	70 mm	8 mm	6 mm	0,3 mm	Steel	4500
SRG080/08	€ 1,57	80 mm	8 mm	6 mm	0,3 mm	Steel	4500
SRG100/10	€ 1,70	100 mm	10 mm	6 mm	0,3 mm	Steel	4500
SRG100/15	€ 2,75	100 mm	15 mm	6 mm	0,3 mm	Steel	4500
SRG030/05I	€ 1,32	30 mm	5 mm	6 mm	0,3 mm	Stainless steel	4500
SRG040/05I	€ 1,42	40 mm	5 mm	6 mm	0,3 mm	Stainless steel	4500
SRG050/06I	€ 1,85	50 mm	6 mm	6 mm	0,3 mm	Stainless steel	4500
SRG060/06I	€ 1,94	60 mm	6 mm	6 mm	0,3 mm	Stainless steel	4500
SRG070/08I	€ 2,24	70 mm	8 mm	6 mm	0,3 mm	Stainless steel	4500
SRG080/08I	€ 3,11	80 mm	8 mm	6 mm	0,3 mm	Stainless steel	4500
SRG100/10I	€ 3,38	100 mm	10 mm	6 mm	0,3 mm	Stainless steel	4500
SRG100/15I	€ 4,52	100 mm	15 mm	6 mm	0,3 mm	Stainless steel	4500



SNGx

NYLON BRUSHES ON SHAFT

PACKING OF 10* PIECES

Art.	€	Diameter ø	Shank	Grit	Color	rpm max
SNG075/080R	€ 4,83	75 mm	6 mm	80	Red	4500
SNG075/180B	€ 4,83	75 mm	6 mm	180	Blue	4500
SNG100/080R	€ 5,50	100 mm	6 mm	80	Red	4500
SNG100/180B	€ 5,70	100 mm	6 mm	180	Blue	4500



SGRx

TWISTED KNOTS BRUSH WITH SHAFT

CLEANING, REMOVAL OF RUST AND WELD SEAMS

PACKING OF 10* PIECES

Art.	€	Diameter ø	Shank	Wire	Material	rpm max
SGR075	€ 3,19	75 mm	6 mm	0,5 mm	Steel	12000
SGR075I	€ 4,02	75 mm	6 mm	0,5 mm	Stainless steel	12000



SCGx

BEVEL BRUSHES WITH SHAFT

FOR LIGHT AND MEDIUM RUST AND VARNISH REMOVAL AND DEBURRING

PACKING OF 10* PIECES

Art.	€	Diameter ø	Shank	Wire	Material	rpm max
SCG090	€ 3,38	90 mm	6 mm	0,3 mm	Steel	12500
SCG090I	€ 4,86	90 mm	6 mm	0,3 mm	Stainless steel	12500



STGx

CUP BRUSHES WITH SHAFT

CUP SHAPE, TO REACH THE BOTTOMS AND TO WORK FRONTALLY

PACKING OF 25* PIECES

Art.	€	Diameter ø	Shank	Wire	Material	rpm max
STG050	€ 1,33	50 mm	6 mm	0,3 mm	Steel	6500
STG070	€ 1,72	70 mm	6 mm	0,3 mm	Steel	4500
STG050I	€ 2,03	50 mm	6 mm	0,3 mm	Stainless steel	6500
STG070I	€ 2,58	70 mm	6 mm	0,3 mm	Stainless steel	4500



SFGx

END BRUSHES

SUITED FOR HARD-TO-REACH SPOTS AND FRONTAL CLEANING.

PACKING OF 25* PIECES

Art.	€	Diameter ø	Shank	Wire	Material	rpm max
SFG010	€ 1,13	10 mm	6 mm	0,3 mm	Steel	20000
SFG015	€ 1,49	15 mm	6 mm	0,3 mm	Steel	20000
SFG020	€ 1,85	20 mm	6 mm	0,3 mm	Steel	20000
SFG025	€ 2,08	25 mm	6 mm	0,3 mm	Steel	20000
SFG030	€ 2,75	30 mm	6 mm	0,3 mm	Steel	20000
SFG010I	€ 1,47	10 mm	6 mm	0,3 mm	Stainless steel	20000
SFG015I	€ 2,07	15 mm	6 mm	0,3 mm	Stainless steel	20000
SFG020I	€ 2,55	20 mm	6 mm	0,3 mm	Stainless steel	20000
SFG025I	€ 2,75	25 mm	6 mm	0,3 mm	Stainless steel	20000
SFG030I	€ 4,08	30 mm	6 mm	0,3 mm	Stainless steel	20000



SFP012

CAT 42

TIP END BRUSHES

PACKING OF 25* PIECES FOR STEEL, PACKING OF 10* PIECES FOR STAINLESS STEEL

Art.	€	Diameter ø	Shank	Wire	Material	rpm max
SFP012	€ 1,75	12 mm	6 mm	0.3 mm	Steel	20000
SFP024	€ 2,55	24 mm	6 mm	0.3 mm	Steel	20000
SFP012I	€ 1,32	12 mm	6 mm	0.3 mm	Stainless steel	20000
SFP024I	€ 3,20	24 mm	6 mm	0.3 mm	Stainless steel	20000



SFRx

TWISTED KNOTS END BRUSHES

SUITED FOR HARD-TO-REACH SPOTS AND FRONTAL CLEANING.

PACKING OF 10* PIECES

Art.	€	Diameter ø	Shank	Wire	Material	rpm max
SFR019	€ 3,43	19 mm	6 mm	0,5 mm	Steel	20000
SFR022	€ 3,78	22 mm	6 mm	0,5 mm	Steel	20000
SFR019I	€ 5,30	19 mm	6 mm	0,5 mm	Stainless steel	20000
SFR022I	€ 5,80	22 mm	6 mm	0,5 mm	Stainless steel	20000



0331

€ 26,00

WIRE BRUSH SET FOR AUTOMOTIVE AND WORKSHOP

WITH EXTENSION AND PLASTIC HANDLE



Box

Sizes Ø 9 - 11 - 13 - 15 - 17 - 19 mm
Material Nylon - Steel - Brass

0251

€ 1,72

STEEL BRUSH



Box

Length 240 mm

SMCx

HAND BRUSHES

FOR HAND CLEANING OPERATIONS

Art.	€	Size	Material
SMC275	€ 1,38	275 mm	Steel
SMC275I	€ 2,78	275 mm	Stainless steel



CSCD-

ABRASIVE NYLON DISCS

FOR THE CLEANING OF WELDS ON STAINLESS STEEL, DEOXIDATION AND CLEANING OF WELDING, REMOVAL OF RUST AND CALAMINE, POLISHING SURFACES STUCK WITH RUBBER, PLASTIC MATERIALS AND OTHERS



PACKING OF 5* PIECES

Backings: Fiberglass Abrasive: Nylon & Silicon carbide \triangle Flat

Art.	€	Dimensions	rpm max
CSCD/F115	€ 5,50	115 x 22 mm	11000
CSCD/F180	€ 8,00	180 x 22 mm	7000
CSCD/F115HD	€ 6,10	115 x 22 mm	11000



CSDS-

FLAT DISCS WITH HOLE FOR DRILL

FLAT DISCS WITH HOLE FOR DRILL

Art.	€	Diameter	rpm max
CSDS/100	€ 3,67	100 mm	8000
CSDS/150	€ 6,00	150 mm	5350
CSDS/200	€ 9,20	200 mm	4000



CSF-

ABRASIVE NYLON BLACK CLEANER

FAST LOCK. SUITED FOR RUST, VARNISH AND OXIDATIONS REMOVAL.

PACKING OF 10* PIECES

Nylon & silicon carbide

Art.	€	Diameter ϕ	rpm max
CSF/050	€ 2,62	50 mm	12000
CSF/075	€ 4,03	75 mm	8000

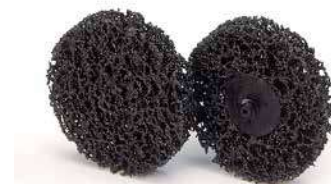

ADF-

FASTENING SHAFT

Art.	€	Dimensions	Type
ADF/01	€ 1,75	10 x 6 mm	25
ADF/02	€ 1,83	12,8 x 8 mm	24



DISCS MADE OF NYLON FIBERS VERY RESISTANT, ENRICHED WITH COARSE GRAIN SILICON CARBIDE ABRASIVE. OPERATING SPEED: BETWEEN 20 AND 25 M/SEC., DEPENDING ON THE PROCESSING TO CARRY OUT. FOR STAINLESS STEEL, STEEL, CAST METAL, NON-FERROUS METAL, ALUMINIUM



UNCD-

NON WOVEN ABRASIVE DISCS FOR SURFACE FINISHING

IMPREGNATED WITH RESIN AND COMPRESSED.

Available grits

- S/C-F (FINE) - ACCURATE FINISHING- LIGHT WORKING PRESSURE
- S/C-M (MEDIUM) - MEDIUM FINISHING- LIGHT WORKING PRESSURE
- A/O-C (COARSE) - MORE AGGRESSIVE CUTTING - MEDIUM WORKING PRESSURE



PACKING OF 5* PIECES

Backings: Fiberglass Abrasive: Silicon carbide Flat



Art.	€	Dimensions	Grit	rpm max
UNCD/F115F	€ 12,90	115 x 22 mm	S/C-F	11000
UNCD/F115M	€ 12,90	115 x 22 mm	S/C-M	11000
UNCD/F115C	€ 12,90	115 x 22 mm	A/O-C	11000

UNPx

UNITIZED FLAT DISCS

SUITED FOR CORNER BLENDING AND FINISHING, TO BE USED WITH LOW SPEED ANGLE GRINDERS. THE PRODUCT MUST WORK ON THE EDGE, DO NOT EXERT LATERAL PRESSURE

PACKING OF 5* PIECES

Backings: Silicon carbide



Art.	€	Diameter ø	Thickness	Hole	Grit	rpm max
UNP115/6/3SF	€ 10,00	115 mm	6 mm	22 mm	3 S.Fine	5000
UNP115/6/6SM	€ 11,60	115 mm	6 mm	22 mm	6 S.Medium	5000
UNP125/6/3SF	€ 11,60	125 mm	6 mm	22 mm	3 S.Fine	5000
UNP125/6/6SM	€ 13,50	125 mm	6 mm	22 mm	6 S.Medium	5000

UNFx

UNITIZED DISCS

3AM MEDIUM HARDNESS, MEDIUM GRIT SIZE BLENDING, REMOVAL GRINDING SCRATCHES, LIGHT DEBURRING OF EDGES. 6AC HARD, COARSE GRIT SIZE. DEBURRING, HEAVY BRUSHING, REMOVAL OF DEEP SCRATCHES AND OXIDATIONS. 6SF VERY HARD, FINE GRIT SIZE. LONGER LIFE AND BETTER REISTANCE BUT LESS CONFORMABILITY TO WORK PIECE.

PACKING OF 5* PIECES

Art.	€	Diameter ø	Thickness	Hole	Grit	rpm max
UNF150/6/3AM	€ 16,50	150 mm	6 mm	25 mm	3 A.Medium	5000
UNF150/6/6SF	€ 16,70	150 mm	6 mm	25 mm	6 S.Fine	5000
UNF150/6/6AC	€ 19,60	150 mm	6 mm	25 mm	6 A.Coarse	5000



FOR LIGHT DEBURRING, CLEANING, FINISHING, MARKS AND IMPERFECTIONS REMOVAL ON ALL TYPES OF METAL SUCH AS STAINLESS STEEL, IRON, ALUMINIUM, ALLOYS, TITANIUM. UNCD-F DISCS FIT PERFECTLY FOR PROCESSING PLASTIC AND COMPOSITES. IDEAL FOR FINISHING AFTER WORKING WITH FLAP DISCS AND FIBER DISCS.

SCDx

SURFACE CONDITIONING FLAP DISCS

FAST AND STEADY FINISH WITHOUT CLOGGING, COOLER CUT. INCREASED LIFETIME COMPARED TO STANDARD SURFACE CONDITIONING DISCS



PACKING OF 10* PIECES

Art.	€	Dimensions	Grit	rpm max
SCD115/C	€ 5,80	Ø 115 x 22 mm	Coarse	13300
SCD115/M	€ 5,80	Ø 115 x 22 mm	Medium	13300
SCD115/VF	€ 5,80	Ø 115 x 22 mm	Very Fine	13300
SCD125/C	€ 7,10	Ø 125 x 22 mm	Coarse	12200
SCD125/M	€ 7,10	Ø 125 x 22 mm	Medium	12200
SCD125/VF	€ 7,10	Ø 125 x 22 mm	Very Fine	12200

VSCx

SURFACE CONDITIONING DISCS

SURFACE PREPARATION FOR PAINTING, TO REPAIR DEFECTS WITH AN UNIFORM SATIN FINISH. REMOVES OXIDATION, SCRATCHES, VARNISHES, WELDING MARKS.

PACKING OF 10* PIECES



Art.	€	Diameter Ø	Grit	rpm max
VSC115/080C	€ 2,82	115 mm	Coarse (80)	5100
VSC115/120M	€ 2,82	115 mm	Medium (120)	5100
VSC115/240VF	€ 2,82	115 mm	Very Fine (240)	5100

PARx

NON WOVEN ROLLS

RESILIENT ROLLS OF NON-WOVEN STRUCTURE UNITED WITH ABRASIVE GRITS. WATER AND OIL RESISTANT, SUITABLE FOR CLEANING, SATINING, FINISHING, BLENDING, POLISHING: METAL, WOOD, PLASTIC, CERAMIC

Plastic bag

Art.	€	Dimensions	Grit
PAR115/120AM	€ 36,70	115 mm x 10 m	A.Medium (120)
PAR115/180AF	€ 36,70	115 mm x 10 m	A.Fine (180)
PAR115/320AVF	€ 36,70	115 mm x 10 m	A.Very Fine (320)
PAR115/600AUF	€ 36,70	115 mm x 10 m	A.Ultra Fine (600)



FPA120-

NONWOVEN SHEETS

PACKING OF 10* PIECES

Art.	€	Dimensions	Grit
FPA120/M	€ 1,50	115 x 280 mm	A.Medium (120)
FPA120/F	€ 1,50	115 x 280 mm	A.Fine (180)
FPA120/VF	€ 1,50	115 x 280 mm	A.Very Fine (320)
FPA120/UF	€ 1,50	115 x 280 mm	S.Ultra Fine (600)



BSAx

FOAM BLOCK

THICK FOAM, ABRASIVE ON FOUR SIDES. WOOD PREPARATION, DOORS AND WINDOWS, ANGLES, DE-NIBBING. DRY AND WET SANDING, CAN BE WASHED AND REUSED.

PACKING OF 20* PIECES



Art.	€	Dimensions	Grit
BSA100/060C	€ 0,82	98 x 69 x 26 mm	Coarse (60)
BSA100/100M	€ 0,82	98 x 69 x 26 mm	Medium (100)
BSA100/180F	€ 0,82	98 x 69 x 26 mm	Fine (180)

FSAx

FOAM PAD

VERY FLEXIBLE, ABRASIVE ON BOTH SIDES. DRY AND WET SANDING, CAN BE WASHED AND REUSED. FURNITURE INDUSTRY, AUTO BODY REPAIR, WOOD PREPARATION.

PACKING OF 20* PIECES



Art.	€	Dimensions	Grit
FSA120/060C	€ 0,77	120 x 98 x 13 mm	Coarse (60)
FSA120/100M	€ 0,77	120 x 98 x 13 mm	Medium (100)
FSA120/180F	€ 0,77	120 x 98 x 13 mm	Fine (180)

BGAx

CAT 42

ABRASIVE RUBBER BLOCKS

Art.	€	Dimensions	Grit
BGA8050/036	€ 8,40	80 x 50 x 20 mm	36
BGA8050/060	€ 8,40	80 x 50 x 20 mm	60
BGA8050/120	€ 8,40	80 x 50 x 20 mm	120
BGA8050/240	€ 8,40	80 x 50 x 20 mm	240



SALx

POLISHING SPONGES

AVAILABLE IN DIFFERENT FLEXIBILITY AND POROSITY, IDEAL FOR POLISHING WITH POLISHING PASTES. YELLOW: FIRST POLISHING, HIGH CUT. BLUE: FIRST POLISHING FAST CUT ORANGE: POLISHING, MEDIUM CUT WHITE: POLISHING, MEDIUM CUT BLACK: FINAL POLISHING

Plastic bag

Art.	€	Diameter ø	Thickness	Color	rpm max
SAL80Y	€ 4,33	80 mm	25 mm	Yellow	8000
SAL80B	€ 3,27	80 mm	25 mm	Blue	8000
SAL80O	€ 3,25	80 mm	25 mm	Orange	8000
SAL80W	€ 3,07	80 mm	25 mm	White	8000
SAL80K	€ 3,07	80 mm	25 mm	Black	8000
SAL150Y	€ 11,90	150 mm	50 mm	Yellow	4500
SAL150B	€ 9,30	150 mm	50 mm	Blue	4500
SAL150O	€ 9,00	150 mm	50 mm	Orange	4500
SAL150W	€ 7,50	150 mm	50 mm	White	4500
SAL150K	€ 7,50	150 mm	50 mm	Black	4500



PAS-

GRINDING PASTES

WHITE: FAT PASTE FOR ROUGHING-UP AND PRELIMINARY WORK WITH SISAL, TAMPICO, WIRE BRUSHES. SUITED FOR IRON, ALUMINIUM, ZAMAK STAINLESS STEEL, SILVER, BRASS. BLUE: FAT MEDIUM PASTE FOR POLISHING AND SECOND CUT ON MEDIUM SMOOTH SURFACES. FOR STEEL, ZAMAK, BRASS. PINK: MEDIUM FAT PASTE FOR BUFFING AND POLISHING. SUITED FOR SECOND CUT ON BRASS, ALUMINIUM, ZAMAK, SILVER, CHROME. GREEN: MEDIUM/FAT PASTE, SUITED TO BE USED WITH SISAL FOR STAINLESS FINISHING. YELLOW: CUTTING PASTE FOR PRECIOUS METAL. SILVER, GOLD.

Art.	€	Weight	Color
PAS/W	€ 5,80	900 / 950 g	White
PAS/B	€ 7,70	900 / 950 g	Blue
PAS/P	€ 7,50	900 / 950 g	Pink
PAS/Y	€ 6,60	900 / 950 g	Yellow
PAS/G	€ 6,30	900 / 950 g	Green



S169

€ 8,60

POLISHING KIT



Blister

Weight 250 g

DLFx

FELT FLAP DISCS

SUITED FOR MIRROR POLISHING, TO BE USED WITH COMPOUNDS OR ABRASIVE PASTES. FELT FLAPS ARE FLEXIBLE AND PREVENT OVERHEATING.

Made In RIFLEX



PACKING OF 10* PIECES

Art.	€	Dimensions	rpm max
DLF115	€ 4,50	Ø 115 x 22 mm	6000
DLF125	€ 5,30	Ø 125 x 22 mm	6000

RGFx

FELT FLAP WHEELS

SUITED FOR MIRROR POLISHING, TO BE USED WITH COMPOUNDS OR ABRASIVE PASTES. FELT FLAPS ARE FLEXIBLE AND PREVENT OVERHEATING OF NORMAL FELT WHEELS.

PACKING OF 10* PIECES

Art.	€	Diameter Ø	Thickness	Shank	rpm max
RGF030/30	€ 4,50	30 mm	30 mm	6 mm	12500
RGF040/30	€ 5,00	40 mm	30 mm	6 mm	9500
RGF050/30	€ 5,70	50 mm	30 mm	6 mm	7500
RGF060/30	€ 6,30	60 mm	30 mm	6 mm	6000
RGF080/30	€ 8,50	80 mm	30 mm	6 mm	4500

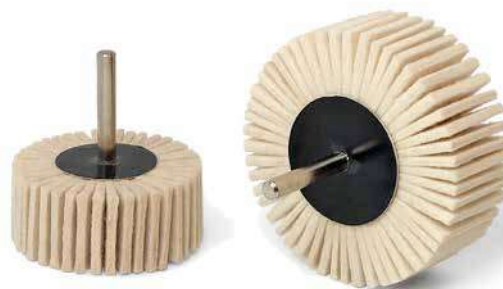

DFFx

FELT DISCS

SUITED FOR POLISHING . TO BE USED WITH COMPOUND OR DIAMOND PASTE. BEST PERIPHERAL SPEED 5-10 M/S

Plastic bag

Art.	€	Diameter Ø	Thickness	Hole
DFF100/13	€ 5,80	100 mm	13 mm	10 mm
DFF150/13	€ 10,40	150 mm	13 mm	15 mm
DFF150/25	€ 18,80	150 mm	25 mm	15 mm
DFF200/13	€ 16,00	200 mm	13 mm	15 mm
DFF200/25	€ 32,80	200 mm	25 mm	15 mm



MFGx

FELT POINT

SUITED FOR POLISHING CUT OFF FORMS. TO BE USED WITH DIAMOND PASTE. BEST PERIPHERAL SPEED 5-10 M/S.

PACKING OF 10* PIECES



Art.	€	Shape	Diameter ø	Thickness	Shank
MFG0610/03A	€ 1,17	A	6 mm	10 mm	3 mm
MFG0810/03A	€ 1,17	A	8 mm	10 mm	3 mm
MFG1014/06A	€ 1,22	A	10 mm	14 mm	6 mm
MFG1520/06A	€ 1,30	A	15 mm	20 mm	6 mm
MFG0812/03K	€ 1,23	K	8 mm	12 mm	3 mm
MFG1018/06K	€ 1,30	K	10 mm	18 mm	6 mm

Art.	€	Shape	Diameter ø	Thickness	Shank
MFG1530/06K	€ 2,23	K	15 mm	30 mm	6 mm
MFG1530/06C	€ 2,22	C	15 mm	30 mm	6 mm
MFG2025/06C	€ 2,35	C	20 mm	25 mm	6 mm
MFG2530/06C	€ 3,52	C	25 mm	30 mm	6 mm
MFG2025/06L	€ 2,27	L	20 mm	25 mm	6 mm
MFG2530/06L	€ 3,08	L	25 mm	30 mm	6 mm

VDFx

VELCRO FELT DISCS

SUITED FOR POLISHING. TO BE USED WITH COMPOUND OR DIAMOND PASTE.

PACKING OF 10* PIECES



Art.	€	Diameter ø	Thickness	rpm max
VDF075	€ 3,52	75 mm	5 mm	6000
VDF115	€ 4,10	115 mm	5 mm	4000
VDF125	€ 4,67	125 mm	5 mm	3500
VDF150	€ 6,50	150 mm	5 mm	3000
VDF180	€ 8,60	180 mm	5 mm	2500

DFC115/M14

€ 16,40

CONICAL FELT DISC

SUITED FOR POLISHING. TO BE USED WITH COMPOUND OR DIAMOND PASTE.



Diameter ø	115 mm
Thickness	12 mm
Thread	M14
rpm max	12500

RFF100

CAT 42 € 49,70

VENTILATED FELT WHEEL



Dimensions	110 x 100 mm
Hole diameter	19 mm

DCK100

€ 4,03

VENTILATED COTTON DISCS

MIRROR POLISHING. 10 DISCS TO GET A 100 MM WHEEL

PACKING OF 10* PIECES



Diameter ø	100 mm
Hole	19,1 mm

DSK100

€ 6,40

SISAL/COTTON DISCS

SUITED FOR INOX TO ELIMINATE ABRASIVE MERKS AND BEFORE POLISHING OPERATIONS WITH FELT OR COTTON. 7 DISCS TO GET A 100 MM WHEEL

PACKING OF 10* PIECES



Diameter ø	100 mm
Hole	19,1 mm

DSCx

SISAL & COTTON DISCS

SUITED FOR STAINLESS STEEL TO ELIMINATE ABRASIVE MARKS AND BEFORE POLISHING OPERATIONS WITH FELT OR COTTON. TO BE USED WITH PASTES.



Plastic bag

Art.	€	Diameter ø	Hole
DSC150	€ 5,80	150 mm	20 mm
DSC200	€ 11,30	200 mm	20 mm
DSC250	€ 14,40	250 mm	20 mm

DCVx

VENTILATED DISCS

VENTILATED COTTON DISCS.



Plastic bag

Art.	€	Diameter ø	Hole	Layers
DCV150	€ 3,88	150 mm	20 mm	8
DCV200	€ 10,40	200 mm	20 mm	16

DCTx

STITCHED COTTON DISCS

LAYERS OF COTTON BONDED TOGETHER BY CONCENTRIC STITCHING. SUITED FOR POLISHING, TO BE USED WITH PASTES.



Plastic bag

Art.	€	Diameter ø	Hole
DCT150	€ 4,42	150 mm	12 mm
DCT200	€ 7,00	200 mm	20 mm
DCT250	€ 12,80	250 mm	20 mm

DSTx

SISAL STITCHED DISCS

SUITED FOR STAINLESS STEEL TO ELIMINATE ABRASIVE MARKS AND BEFORE POLISHING OPERATIONS WITH FELT OR COTTON. TO BE USED WITH PASTES.



Plastic bag

Art.	€	Diameter ø	Hole
DST150	€ 6,00	150 mm	20 mm
DST200	€ 11,80	200 mm	20 mm
DST250	€ 17,20	250 mm	20 mm

DMV150

€ 4,50

VENTILATED DISCS

VENTILATED SISAL AND COTTON DISCS.



Plastic bag

Diameter ø	150 mm
Hole	20 mm
Layers	2

DC200

€ 19,70

CORRUGATED DISCS

CARDBOARD CORE



Plastic bag

Diameter ø	200 mm
Hole	20 mm
Layers	14

DCGx

SHAFT MOUNTED COTTON BUFFINGS

SUITED FOR POLISHING. TO BE USED WITH PASTES. BEST PERIPHERAL SPEED 5-10 M/S

PACKING OF 10* PIECES



Art.	€	Diameter ø	Thickness	Shank
DCG050	€ 3,18	50 mm	12 mm	6 mm
DCG080	€ 4,02	80 mm	12 mm	6 mm
DCG100	€ 4,83	100 mm	12 mm	6 mm

CCGx

DOME MOPS

FOR POLISHING, FOR USE WITH ABRASIVE PASTE. OPTIMAL PERIPHERAL SPEED 5-10 M/S.

PACKING OF 5* PIECES



Art.	€	Diameter ø	Shank
CCG50	€ 5,70	50 mm	6 mm
CCG75	€ 8,90	75 mm	6 mm

VLA200

€ 17,30

TWISTED LAMBS WOOL DISC

POLISHING OF PAINTED SURFACES AND MARBLE.



Plastic bag

Diameter ø	200 mm
------------	--------

DNW100

€ 2,55

WHITE NON WOVEN POLISHING DISCS

PACKING OF 10* PIECES



Diameter ø	100 mm
Hole	10 mm

FCGx

FLARE BUFFS

PACKING OF 10* PIECES



Art.	€	Diameter ø	Shank
FCG50	€ 3,87	50 mm	6 mm
FCG75	€ 5,80	75 mm	6 mm

PNS

€ 1,95

SHAFT

SHAFT FOR VENTILATED DISC DNW



PLV175

€ 23,30

BACKING PAD FOR LAMBS WOOL DISCS

BACKING PAD SUITED FOR VLA200



Plastic bag

Diameter ø	175 mm
------------	--------

VDLx
POLISHING LAMB'S WOOL

MERINOS LAMB WOOL. IDEAL FOR POLISHING ALL PAINTED SURFACES WITH VELCRO BACK



Plastic bag

Art.	€	Diameter ø
VDL075	€ 5,30	75 mm
VDL115	€ 6,50	115 mm
VDL125	€ 7,30	125 mm
VDL150	€ 8,80	150 mm
VDL180	€ 11,10	180 mm

VSPx
POLYURETHANE BACKING PADS

HIGH & MIDDLE PROFILE SOFT BACKING PADS FOR CONTOUR POLISHING. PUR MOLDED, SOFT, GOOD REBOUNDING AND DURABILITY. IDEAL FOR CONTOUR FACE POLISHING, E.G. CAR BODY, FIBERGLASS PIECE, BOAT, FLOOR ETC. SUGGESTED TO WORK WITH LAMBSWOOL PADS, FOAM PADS AND ABRASIVE DISCS.



Plastic bag

Art.	€	Diameter ø	Thread	rpm max
VSP075	€ 8,10	75 mm	M14	12200
VSP115	€ 8,80	115 mm	M14	10000
VSP125	€ 9,20	125 mm	M14	10000
VSP150	€ 10,60	150 mm	M14	7000
VSP180	€ 11,10	180 mm	M14	5000



D17x

ABRASIVE WHEELS

PACKING OF 10* PIECES

Aluminium oxide

Art.	€	Sizes	Grit
D174	€ 1,19	150 mm	60
D175	€ 1,19	150 mm	100
D178/060	€ 1,19	200 mm	60
D178/100	€ 1,19	200 mm	100
D176	€ 2,00	226 mm	60
D177	€ 2,00	226 mm	100



DFVx-xZ

VULCANISED FIBRE DISCS

FIBER DISCS ARE CONSTITUTED BY A VULCANISED CELLULOSE FIBER SUPPORT OF 0,8 MM. THICKNESS. VARIOUS TYPES OF ABRASIVE ARE DEPOSITED ON IT. THESE ARE FASTENED WITH A DOUBLE LAYER OF THERMOSETTING RESIN ADDED WITH ACTIVE FILLERS WHICH GIVE THE PRODUCTS COOLING AND ANTI-CLOGGING PROPERTIES. APPLIED TO A BACKING PAD AS SUPPORT, THE DISCS ARE USED ON PORTABLE SANDER.

Zirconia

Art.	€	Dimensions	Grit	rpm max
DFV115/036Z	€ 0,73	115 x 22 mm	36	13300
DFV115/040Z	€ 0,65	115 x 22 mm	40	13300
DFV115/060Z	€ 0,60	115 x 22 mm	60	13300
DFV115/080Z	€ 0,55	115 x 22 mm	80	13300
DFV115/120Z	€ 0,48	115 x 22 mm	120	13300
DFV180/036Z	€ 1,65	180 x 22 mm	36	8600
DFV180/040Z	€ 1,47	180 x 22 mm	40	8600
DFV180/060Z	€ 1,27	180 x 22 mm	60	8600
DFV180/080Z	€ 1,22	180 x 22 mm	80	8600
DFV180/120Z	€ 1,08	180 x 22 mm	120	8600



PACKING OF 25* PIECES

DFVx-xA

VULCANISED FIBRE DISCS

FIBER DISCS ARE CONSTITUTED BY A VULCANISED CELLULOSE FIBER SUPPORT OF 0,8 MM. THICKNESS. VARIOUS TYPES OF ABRASIVE ARE DEPOSITED ON IT. THESE ARE FASTENED WITH A DOUBLE LAYER OF THERMOSETTING RESIN ADDED WITH ACTIVE FILLERS WHICH GIVE THE PRODUCTS COOLING AND ANTI-CLOGGING PROPERTIES. APPLIED TO A BACKING PAD AS SUPPORT, THE DISCS ARE USED ON PORTABLE SANDER.

Aluminium oxide

Art.	€	Dimensions	Grit	rpm max
DFV115/024A	€ 0,52	115 x 22 mm	24	13300
DFV115/036A	€ 0,55	115 x 22 mm	36	13300
DFV115/060A	€ 0,52	115 x 22 mm	60	13300
DFV115/080A	€ 0,43	115 x 22 mm	80	13300
DFV115/120A	€ 0,43	115 x 22 mm	120	13300
DFV180/024A	€ 1,17	180 x 22 mm	24	8600
DFV180/036A	€ 1,13	180 x 22 mm	36	8600
DFV180/060A	€ 1,05	180 x 22 mm	60	8600
DFV180/080A	€ 1,00	180 x 22 mm	80	8600



PACKING OF 25* PIECES

PFBx

BACKING PADS

STANDARD BACKING PAD FOR FIBRE DISCS, PROFESSIONAL, HARD.



Plastic bag

Art.	€	Diameter ø	Thread	rpm max
PFB115	€ 4,50	115 mm	M14	13300
PFB180	€ 7,80	180 mm	M14	8500

PFSx

BACKING PADS

BACKING PADS WITH COOLING RIPS FOR ROUGH AND COOLING GRINDING, VERY HARD.



Plastic bag

Art.	€	Diameter ø	Thread	rpm max
PFS115	€ 8,70	115 mm	M14	13300
PFS180	€ 15,60	180 mm	M14	8500

VDAx

VELCRO DISCS

HIGH QUALITY F WEIGHT AL.OXIDE, FOR INDUSTRIAL APPLICATIONS.SANDING OF METAL, WOOD, LEATHER.

PACKING OF 100* PIECES

Aluminium oxide

Art.	€	Diameter ø	Holes	Grit
VDA115/040	€ 0,27	115 mm	-	40
VDA115/060	€ 0,27	115 mm	-	60
VDA115/080	€ 0,27	115 mm	-	80
VDA115/100	€ 0,27	115 mm	-	100
VDA115/120	€ 0,27	115 mm	-	120
VDA115/180	€ 0,27	115 mm	-	180
VDA115/220	€ 0,27	115 mm	-	220
VDA125/40F8	€ 0,33	125 mm	8	40
VDA125/60F8	€ 0,30	125 mm	8	60
VDA125/80F8	€ 0,30	125 mm	8	80
VDA125/100F8	€ 0,30	125 mm	8	100
VDA125/120F8	€ 0,30	125 mm	8	120
VDA125/180F8	€ 0,30	125 mm	8	180
VDA125/220F8	€ 0,30	125 mm	8	220
VDA150/040	€ 0,42	150 mm	-	40
VDA150/060	€ 0,38	150 mm	-	60
VDA150/080	€ 0,38	150 mm	-	80
VDA150/100	€ 0,38	150 mm	-	100
VDA150/120	€ 0,38	150 mm	-	120
VDA150/180	€ 0,38	150 mm	-	180
VDA150/220	€ 0,38	150 mm	-	220
VDA150/040F6	€ 0,42	150 mm	6	40
VDA150/060F6	€ 0,38	150 mm	6	60
VDA150/080F6	€ 0,38	150 mm	6	80
VDA150/100F6	€ 0,38	150 mm	6	100
VDA150/120F6	€ 0,38	150 mm	6	120
VDA150/180F6	€ 0,38	150 mm	6	180
VDA150/220F6	€ 0,38	150 mm	6	220



VDGx

CAT 42

VELCRO DISCS "GOLD"

PACKING OF 100* PIECES

Art.	€	Diameter	Grit	Holes
VDG150/060	€ 0,40	ø 150 mm	60	-
VDG150/080	€ 0,38	ø 150 mm	80	-
VDG150/120	€ 0,38	ø 150 mm	120	-
VDG150/150	€ 0,38	ø 150 mm	150	-
VDG150/180	€ 0,38	ø 150 mm	180	-
VDG150/220	€ 0,38	ø 150 mm	220	-
VDG150/320	€ 0,38	ø 150 mm	320	-
VDG150/400	€ 0,38	ø 150 mm	400	-
VDG150/600	€ 0,38	ø 150 mm	600	-
VDG150/800	€ 0,38	ø 150 mm	800	-
VDG150/060F6	€ 0,40	ø 150 mm	60	6
VDG150/080F6	€ 0,38	ø 150 mm	80	6
VDG150/120F6	€ 0,38	ø 150 mm	120	6
VDG150/150F6	€ 0,38	ø 150 mm	150	6
VDG150/180F6	€ 0,38	ø 150 mm	180	6
VDG150/220F6	€ 0,38	ø 150 mm	220	6
VDG150/320F6	€ 0,38	ø 150 mm	320	6
VDG150/400F6	€ 0,38	ø 150 mm	400	6
VDG150/600F6	€ 0,38	ø 150 mm	600	6
VDG150/800F6	€ 0,38	ø 150 mm	800	6
VDG150/060F8	€ 0,40	ø 150 mm	60	8
VDG150/080F8	€ 0,38	ø 150 mm	80	8
VDG150/120F8	€ 0,38	ø 150 mm	120	8
VDG150/150F8	€ 0,38	ø 150 mm	150	8
VDG150/180F8	€ 0,38	ø 150 mm	180	8
VDG150/220F8	€ 0,38	ø 150 mm	220	8
VDG150/320F8	€ 0,38	ø 150 mm	320	8
VDG150/400F8	€ 0,38	ø 150 mm	400	8
VDG150/600F8	€ 0,38	ø 150 mm	600	8
VDG150/800F8	€ 0,38	ø 150 mm	800	8

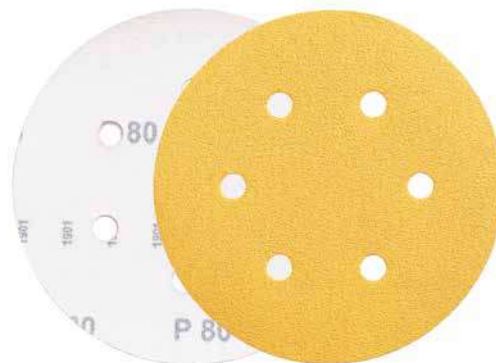

ZSAx

VELCRO DISCS

DOUBLE RESIN STEARATE C WEIGHT PAPER, OPEN COAT. DRY SANDING OF PRIMERS, FILLERS, PAINTS, PLASTIC.

Aluminium oxide stearate

Art.	€	Diameter ø	Holes	Grit
ZSA150/080	€ 0,38	150 mm	-	80
ZSA150/120	€ 0,35	150 mm	-	120
ZSA150/180	€ 0,35	150 mm	-	180
ZSA150/240	€ 0,35	150 mm	-	240
ZSA150/320	€ 0,35	150 mm	-	320
ZSA150/400	€ 0,35	150 mm	-	400
ZSA150/80F6	€ 0,38	150 mm	6	80
ZSA150/120F6	€ 0,35	150 mm	6	120
ZSA150/180F6	€ 0,35	150 mm	6	180
ZSA150/240F6	€ 0,35	150 mm	6	240
ZSA150/320F6	€ 0,35	150 mm	6	320
ZSA150/400F6	€ 0,35	150 mm	6	400

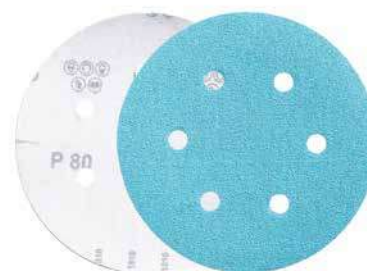

PACKING OF 100* PIECES

VDZx

VELCRO DISCS

ZIRCONIA CLOTH, CLOSED COATING. RAPID MATERIAL REMOVAL, VERY LONG LIFE. THE HEAVIER SUPPORT CAN RESIST TO HIGHER SPEED AND PRESSURE COMPARED TO PAPER BACKING. WET AND DRY WORKING ON STEELS, SPECIAL ALLOYS, LEATHER, HARD WOOD.

Zirconia

Art.	€	Diameter ø	Grit
VDZ115/040	€ 0,57	115 mm	40
VDZ115/060	€ 0,55	115 mm	60
VDZ115/080	€ 0,51	115 mm	80
VDZ115/120	€ 0,47	115 mm	120
VDZ125/040	€ 0,69	125 mm	40
VDZ125/060	€ 0,59	125 mm	60
VDZ125/080	€ 0,57	125 mm	80
VDZ125/120	€ 0,51	125 mm	120
VDZ150/040	€ 0,91	150 mm	40
VDZ150/060	€ 0,77	150 mm	60
VDZ150/080	€ 0,72	150 mm	80
VDZ150/120	€ 0,69	150 mm	120



PACKING OF 100* PIECES

VDRx

VELCRO SANDING SCREEN

ABRASIVES MESH IS COATED ON SCREEN, WHILE CONVENTIONAL ABRASIVES ARE COATED ON PAPERS, THIS GIVES THE FOLLOWING ADVANTAGES: 1. UP TO 90% DUST EXTRACTION, IT'S AN ENVIRONMENTALLY FRIENDLY PRODUCT. 2. NON CLOGGING. 3. HEAT RESISTANT, CAN BE USED ON HIGH-SPEED GRINDING MACHINES. 4. CAN BE USED DRY OR WET. 5. LONGER LIFE COMPARED TO TRADITIONAL SANDPAPER.

Art.	€	Diameter ø	Grit
VDR150/080	€ 0,72	150 mm	80
VDR150/120	€ 0,72	150 mm	120
VDR150/180	€ 0,72	150 mm	180
VDR150/240	€ 0,72	150 mm	240
VDR150/320	€ 0,72	150 mm	320
VDR150/400	€ 0,72	150 mm	400
VDR150/600	€ 0,72	150 mm	600

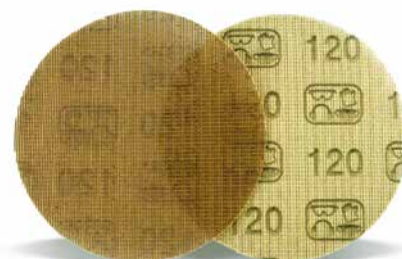

PACKING OF 50* PIECES

VDTx

VELCRO TRIZACT™ DISCS

ALUMINIUM OXIDE GRAINS WITH THE ADDITION OF REFRIGERANT FILLERS BOND TO EACH OTHER IN A PYRAMID SELF SHARPENING SHAPE, WITH A CONSISTENT HEIGHT THAT REMAINS CONSTANT DURING USAGE. THIS MAKES IT POSSIBLE TO REACH UNIFORM AND CONSISTENT FINISH IN A FEW STEPS, THE PERFECT PRODUCT FOR FINISHING. SUITED FOR ALL SORTS OF METAL SURFACES.

Art.	€	Diameter ø	Grit	rpm max
VDT115/A100	€ 3,63	115 mm	A100 (220)	5000
VDT115/A065	€ 3,63	115 mm	A65 (280)	5000
VDT115/A045	€ 3,63	115 mm	A45 (400)	5000
VDT115/A030	€ 3,63	115 mm	A30 (600)	5000
VDT115/A016	€ 3,63	115 mm	A16 (1200)	5000
VDT115/A006	€ 3,63	115 mm	A6 (2000)	5000



PDBx

BACKING PADS WITHOUT FOAM



Plastic bag

Art.	€	Diameter ø	Thread	rpm max
PDB115/M14	€ 8,10	115 mm	M14	13300
PDB125/M14	€ 9,30	125 mm	M14	12200
PDB150/M14	€ 12,50	150 mm	M14	10000

PDMx

BACKING PADS WITH FOAM



Plastic bag

Art.	€	Diameter ø	Thickness	Thread	rpm max
PDM115/12M14	€ 14,50	115 mm	12 mm	M14	13300
PDM125/12M14	€ 16,50	125 mm	12 mm	M14	12200
PDM150/12M14	€ 18,80	150 mm	12 mm	M14	10000

SPA115/M14

€ 17,80

BACKING PAD

BACKING PADS FOR SURFACE
CONDITIONING DISCS.



Plastic bag

Diameter ø	115 mm
Thread	M14
rpm max	13300

PMEx

BACKING PADS WITH FOAM



Plastic bag

Art.	€	Diameter ø	Thickness	rpm max
PME125/18M14	€ 4,50	125 mm	18 mm	6800
PME150/12M14	€ 6,40	150 mm	12 mm	10000

PDVx-M14

CAT 42

**BACKING PAD WITH
VENTILATION**



Art.	€	Diameter ø	Thread
PDV115/M14	€ 27,60	115 mm	M14
PDV125/M14	€ 28,30	125 mm	M14
PDV150/M14	€ 31,10	150 mm	M14

PPSx

POLYURETHANE BACKING PADS

SOFT VERSION



Plastic bag

Art.	€	Diameter ø	Thickness	rpm max
PPS125/27M14	€ 17,80	125 mm	27 mm	8000
PPS150/29M14	€ 19,10	150 mm	29 mm	7000

PFLx

BACKING PADS FOR ORBITAL SANDERS

Plastic bag

Art.	€	Diameter ø	Thickness	Shank	Holes	rpm max
PFL125/10F8	€ 13,00	125 mm	10 mm	5/16" mm	8	12000
PFL150/10	€ 15,10	150 mm	10 mm	5/16" mm	-	10000
PFL150/10F6	€ 16,30	150 mm	10 mm	5/16" mm	6	10000

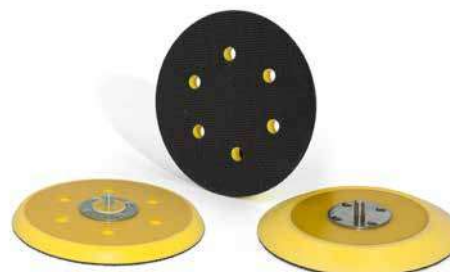

TEV120

CAT 42 € 8,70

BLOCK FOR VELCRO DISCS

ERGONOMIC SHAPE, QUICK CHANGE OF THE ABRASIVE SHEET



Size 70 x 120 mm

TDV

CAT 42 € 15,80

BLOCK FOR VELCRO DISCS

ALLOWS YOU TO USE VELCRO DISCS BY HAND



Size 150 mm

RASx

ANTI WASTE ROLLS

EXTRA FLEXIBLE WITH DOUBLE RESIN FOR MANUAL WORKS OF TO USE WITH ORBITAL SANDERS.

Aluminium oxide Box

Art.	€	Dimensions	Dimensions	Grit
RAS40	€ 23,80	50 mm x 25 m	50 mm x 25 m	40
RAS60	€ 21,40	50 mm x 25 m	50 mm x 25 m	60
RAS80	€ 20,30	50 mm x 25 m	50 mm x 25 m	80
RAS120	€ 17,80	50 mm x 25 m	50 mm x 25 m	120
RAS180	€ 17,80	50 mm x 25 m	50 x 25 mm	180
RAS220	€ 17,80	50 mm x 25 m	50 x 25 mm	220
RAS320	€ 17,80	50 mm x 25 m	50 x 25 mm	320
RAS400	€ 17,80	50 mm x 25 m	50 mm x 25 m	400



RSSx

CAT 42

ANTI-WASTE SPONGE ROLLS

Aluminium oxide

Art.	€	Dimensions	Grit
RSS150	€ 59,40	115 mm x 25 m	150
RSS180	€ 59,40	115 mm x 25 m	180
RSS240	€ 59,40	115 mm x 25 m	240
RSS320	€ 59,40	115 mm x 25 m	320
RSS400	€ 59,40	115 mm x 25 m	400
RSS500	€ 59,40	115 mm x 25 m	500
RSS600	€ 59,40	115 mm x 25 m	600
RSS800	€ 59,40	115 mm x 25 m	800
RSS1000	€ 59,40	115 mm x 25 m	1000



RSRx

CAT 42

VELCRO PAPER ROLLS

Aluminium oxide

Art.	€	Dimensions	Grit
RSR115/050/040	€ 54,30	115 x 50 m mm	40
RSR115/050/060	€ 46,90	115 x 50 m mm	60
RSR115/050/080	€ 43,50	115 x 50 m mm	80
RSR115/050/120	€ 42,50	115 x 50 m mm	120



RSAx

LUBRICANT VELCRO PAPER ROLLS

Aluminium oxide

Art.	€	Dimensions	Grit
RSA115/25/080	€ 41,80	115 mm x 25 m	80
RSA115/25/120	€ 41,80	115 mm x 25 m	120
RSA115/25/150	€ 41,80	115 mm x 25 m	150
RSA115/25/180	€ 41,80	115 mm x 25 m	180
RSA115/25/220	€ 41,80	115 mm x 25 m	220
RSA115/25/320	€ 41,80	115 mm x 25 m	320



FTRx

FLEXIBLE CLOTH

HIGHLY FLEXIBLE AL. OXIDE SHEETS ON A COTTON BACKING, PACKED IN BOXES. FOR HAND WORKING AND PORTABLE SANDERS.

PACKING OF 50* PIECES

Aluminium oxide

Art.	€	Dimensions	Grit
FTR230/040	€ 1,20	230 x 280 mm	40
FTR230/060	€ 1,07	230 x 280 mm	60
FTR230/080	€ 0,98	230 x 280 mm	80
FTR230/120	€ 0,87	230 x 280 mm	120
FTR230/180	€ 0,87	230 x 280 mm	180
FTR230/220	€ 0,87	230 x 280 mm	220
FTR230/320	€ 0,87	230 x 280 mm	320
FTR230/400	€ 0,87	230 x 280 mm	400
FTR230/600	€ 0,98	230 x 280 mm	600



RTFx

RESIN CLOTH ROLLS

HIGHLY FLEXIBLE AL. OXIDE RESIN BONDED CLOTH FOR HANDWORKING AND PORTABLE SANDERS. SUITABLE FOR POLISHING AND SANDING FLAT AND CONTOURED METAL AND WOOD PARTS.

PACKING OF 10* PIECES

Aluminium oxide Plastic bag

Art.	€	Dimensions	Grit
RTF120/005/040	€ 6,40	115 mm x 5 m	40
RTF120/005/060	€ 6,40	115 mm x 5 m	60
RTF120/005/080	€ 6,40	115 mm x 5 m	80
RTF120/005/100	€ 6,40	115 mm x 5 m	100
RTF120/005/120	€ 6,40	115 mm x 5 m	120
RTF120/050/040	€ 52,20	115 mm x 50 m	40
RTF120/050/060	€ 52,20	115 mm x 50 m	60
RTF120/050/080	€ 52,20	115 mm x 50 m	80
RTF120/050/100	€ 52,20	115 mm x 50 m	100
RTF120/050/120	€ 52,20	115 mm x 50 m	120



RCLx

LATEX WATERPROOF ROLLS

FOR WET AND DRY SANDING, USUALLY USED IN POLISHING AND SANDING METAL MOULDS, CARBON FIBER WORKPIECES, FIBER GLASS, COMPOSITE MATERIALS, AND PRECISION INSTRUMENTS.

Aluminium oxide Plastic bag

Art.	€	Dimensions	Grit
RCL115/100/080	€ 103,00	115 mm x 100 m	80
RCL115/100/100	€ 103,00	115 mm x 100 m	100
RCL115/100/120	€ 103,00	115 mm x 100 m	120
RCL115/100/150	€ 103,00	115 mm x 100 m	150
RCL115/100/180	€ 103,00	115 mm x 100 m	180



RCSx

STEARATE ROLLS

STEARATE ROLLS, PREVENT CLOGGING AND STATIC, FLEXIBLE AND HIGH WEAR RESISTANT, IDEAL FOR PAINT SANDING.

Aluminium oxide stearate Plastic bag

Art.	€	Dimensions	Grit
RCS115/050/150	€ 56,70	115 mm x 50 m	150
RCS115/050/180	€ 56,70	115 mm x 50 m	180
RCS115/050/240	€ 56,70	115 mm x 50 m	240
RCS115/050/320	€ 56,70	115 mm x 50 m	320
RCS115/050/400	€ 56,70	115 mm x 50 m	400
RCS115/050/600	€ 56,70	115 mm x 50 m	600



FLIx

LATEX WATERPROOF SHEETS

WET AND DRY SANDING, USUALLY USED IN POLISHING AND SANDING PAINTS, PRECISION INSTRUMENT, METAL, COMPOSITE MATERIALS, AUTOMOBILE PRODUCTION AND REPAIR, ELECTRON.

PACKING OF 100* PIECES

Silicon carbide

Art.	€	Dimensions	Grit
FLI230/240	€ 0,53	230 x 280 mm	240
FLI230/320	€ 0,53	230 x 280 mm	320
FLI230/400	€ 0,53	230 x 280 mm	400
FLI230/600	€ 0,53	230 x 280 mm	600
FLI230/800	€ 0,53	230 x 280 mm	800
FLI230/1000	€ 0,53	230 x 280 mm	1000
FLI230/1200	€ 0,53	230 x 280 mm	1200



SPIxZ

REINFORCED ABRASIVE SPIRABANDS

PACKING OF 100* PIECES

Art.	€	Dimensions	Grit	rpm max
SPI1020/040Z	€ 0,28	10 x 20 mm	40	36000
SPI1020/060Z	€ 0,27	10 x 20 mm	60	36000
SPI1020/080Z	€ 0,27	10 x 20 mm	80	36000
SPI1020/120Z	€ 0,27	10 x 20 mm	120	36000
SPI1530/040Z	€ 0,38	15 x 30 mm	40	26000
SPI1530/060Z	€ 0,37	15 x 30 mm	60	26000
SPI1530/080Z	€ 0,37	15 x 30 mm	80	26000
SPI1530/120Z	€ 0,37	15 x 30 mm	120	26000
SPI2030/040Z	€ 0,45	20 x 30 mm	40	18000
SPI2030/060Z	€ 0,43	20 x 30 mm	60	18000
SPI2030/080Z	€ 0,43	20 x 30 mm	80	18000
SPI2030/120Z	€ 0,43	20 x 30 mm	120	18000
SPI2220/040Z	€ 0,37	22 x 20 mm	40	17000
SPI2220/060Z	€ 0,37	22 x 20 mm	60	17000
SPI2220/080Z	€ 0,37	22 x 20 mm	80	17000
SPI2220/120Z	€ 0,37	22 x 20 mm	120	17000
SPI2525/040Z	€ 0,48	25 x 25 mm	40	15000
SPI2525/060Z	€ 0,45	25 x 25 mm	60	15000
SPI2525/080Z	€ 0,45	25 x 25 mm	80	15000
SPI2525/120Z	€ 0,45	25 x 25 mm	120	15000
SPI3030/040Z	€ 0,53	30 x 30 mm	40	13000
SPI3030/060Z	€ 0,52	30 x 30 mm	60	13000
SPI3030/080Z	€ 0,52	30 x 30 mm	80	13000
SPI3030/120Z	€ 0,52	30 x 30 mm	120	13000
SPI4530/040Z	€ 0,72	45 x 30 mm	40	8500
SPI4530/060Z	€ 0,65	45 x 30 mm	60	8500
SPI4530/080Z	€ 0,65	45 x 30 mm	80	8500
SPI4530/120Z	€ 0,65	45 x 30 mm	120	8500



SGCx

RUBBER HOLDERS

EXPANSION RUBBER HOLDERS, USED TO FIX SPIRABANDS.

Art.	€	Dimensions	Shank	rpm max
SGC1020	€ 5,80	10 x 20 mm	6 mm	36000
SGC1530	€ 5,30	15 x 30 mm	6 mm	26000
SGC2030	€ 7,40	20 x 30 mm	6 mm	18000
SGC2220	€ 5,50	22 x 20 mm	6 mm	17000
SGC2525	€ 7,40	25 x 25 mm	6 mm	15000
SGC3030	€ 7,60	30 x 30 mm	6 mm	13300
SGC4530	€ 9,20	45 x 30 mm	6 mm	8500



CRDxC

CAT 42

CARTRIDGE ROLLS

PACKING OF 50* PIECES



Aluminium oxide

Art.	€	Dimensions	Grit	Shape
CRD0638/060C	€ 0,45	6 x 38 mm	60	Cylindrical
CRD0638/080C	€ 0,45	6 x 38 mm	80	Cylindrical
CRD0638/120C	€ 0,45	6 x 38 mm	120	Cylindrical
CRD1038/040C	€ 0,60	10 x 38 mm	40	Cylindrical
CRD1038/060C	€ 0,60	10 x 38 mm	60	Cylindrical
CRD1038/080C	€ 0,60	10 x 38 mm	80	Cylindrical
CRD1038/120C	€ 0,60	10 x 38 mm	120	Cylindrical

CRDxT

CAT 42

CARTRIDGE ROLLS

PACKING OF 50* PIECES



Aluminium oxide

Art.	€	Dimensions	Grit	Shape
CRD1038/060T	€ 0,68	10 x 38 mm	60	Conical
CRD1038/080T	€ 0,68	10 x 38 mm	80	Conical
CRD1038/120T	€ 0,68	10 x 38 mm	120	Conical
CRD1238/060T	€ 0,82	12 x 38 mm	60	Conical
CRD1238/080T	€ 0,82	12 x 38 mm	80	Conical
CRD1238/120T	€ 0,82	12 x 38 mm	120	Conical

PCR6338

CAT 42 € 7,50

PIN FOR CARTRIDGE ROLLS



NTxA

ABRASIVE BELTS

PACKING OF 10* PIECES



Aluminium oxide

Art.	€	Dimensions	Grit
NT0440/035/040A	€ 1,58	440 x 35 mm	40
NT0440/035/060A	€ 1,58	440 x 35 mm	60
NT0440/035/080A	€ 1,58	440 x 35 mm	80
NT0440/035/120A	€ 1,58	440 x 35 mm	120
NT0533/075/040A	€ 3,01	533 x 75 mm	40
NT0533/075/060A	€ 3,01	533 x 75 mm	60
NT0533/075/080A	€ 3,01	533 x 75 mm	80
NT0533/075/120A	€ 3,01	533 x 75 mm	120
NT0686/050/040A	€ 4,43	686 x 50 mm	40
NT0686/050/060A	€ 4,43	686 x 50 mm	60
NT0686/050/080A	€ 4,43	686 x 50 mm	80
NT0686/050/100A	€ 4,43	686 x 50 mm	100
NT0686/050/120A	€ 4,43	686 x 50 mm	120
NT0914/100/040A	€ 6,20	914 x 100 mm	40
NT0914/100/060A	€ 6,20	914 x 100 mm	60
NT0914/100/080A	€ 6,20	914 x 100 mm	80
NT0914/100/100A	€ 6,20	914 x 100 mm	100
NT0914/100/120A	€ 6,20	914 x 100 mm	120
NT1000/100/040A	€ 6,40	1000 x 100 mm	40
NT1000/100/060A	€ 6,40	1000 x 100 mm	60

Art.	€	Dimensions	Grit
NT1000/100/080A	€ 6,40	1000 x 100 mm	80
NT1000/100/120A	€ 6,40	1000 x 100 mm	120
NT1075/025/040A	€ 3,88	1075 x 25 mm	40
NT1075/025/060A	€ 3,88	1075 x 25 mm	60
NT1075/025/080A	€ 3,88	1075 x 25 mm	80
NT1075/025/100A	€ 3,88	1075 x 25 mm	100
NT1075/025/120A	€ 3,88	1075 x 25 mm	120
NT1219/152/040A	€ 7,00	1219 x 152 mm	40
NT1219/152/060A	€ 7,00	1219 x 152 mm	60
NT1219/152/080A	€ 7,00	1219 x 152 mm	80
NT1219/152/100A	€ 7,00	1219 x 152 mm	100
NT1219/152/120A	€ 7,00	1219 x 152 mm	120
NT1500/120/040A	€ 5,90	1500 x 120 mm	40
NT1500/120/060A	€ 5,90	1500 x 120 mm	60
NT1500/120/080A	€ 5,90	1500 x 120 mm	80
NT1500/120/120A	€ 5,90	1500 x 120 mm	120
NT1750/150/040A	€ 8,70	1750 x 150 mm	40
NT1750/150/060A	€ 8,70	1750 x 150 mm	60
NT1750/150/080A	€ 8,70	1750 x 150 mm	80
NT1750/150/120A	€ 8,70	1750 x 150 mm	120

NTxZ

ABRASIVE BELTS

*CAT 42

PACKING OF 10* PIECES



Zirconia

Art.	€	Dimensions	Grit
NT0330/010/040Z	€ 0,67	330 x 10 mm	40
NT0330/010/060Z	€ 0,58	330 x 10 mm	60
NT0330/010/080Z	€ 0,58	330 x 10 mm	80
NT0330/010/120Z	€ 0,58	330 x 10 mm	120
NT520/020/040Z	€ 0,90	520 x 20 mm	40
NT520/020/060Z	€ 0,77	520 x 20 mm	60
NT520/020/080Z	€ 0,68	520 x 20 mm	80
NT520/020/120Z	€ 0,60	520 x 20 mm	120
NT0610/100/040Z	€ 3,38	610 x 100 mm	40
NT0610/100/060Z	€ 2,98	610 x 100 mm	60
NT0610/100/080Z	€ 2,82	610 x 100 mm	80
NT0610/100/120Z	€ 2,77	610 x 100 mm	120
NT0760/040/040Z	€ 1,83	760 x 40 mm	40
NT0760/040/060Z	€ 1,58	760 x 40 mm	60
NT0760/040/080Z	€ 1,58	760 x 40 mm	80
NT0760/040/120Z	€ 1,58	760 x 40 mm	120
NT0914/100/040Z	€ 4,42	914 x 100 mm	40
NT0914/100/060Z	€ 4,25	914 x 100 mm	60
NT0914/100/080Z	€ 4,25	914 x 100 mm	80
NT0914/100/120Z	€ 4,25	914 x 100 mm	120
NT1000/100/040Z	€ 4,33	1000 x 100 mm	40
NT1000/100/060Z	€ 3,67	1000 x 100 mm	60

Art.	€	Dimensions	Grit
NT1000/100/080Z	€ 3,67	1000 x 100 mm	80
NT1000/100/120Z	€ 3,58	1000 x 100 mm	120
NT1219/152/040Z	€ 9,20	1219 x 152 mm	40
NT1219/152/060Z	€ 7,50	1219 x 152 mm	60
NT1219/152/080Z	€ 7,50	1219 x 152 mm	80
NT1219/152/120Z	€ 7,50	1219 x 152 mm	120
NT1500/120/040Z	€ 7,30	1500 x 120 mm	40
NT1500/120/060Z	€ 6,20	1500 x 120 mm	60
NT1500/120/080Z	€ 6,20	1500 x 120 mm	80
NT1500/120/120Z	€ 6,20	1500 x 120 mm	120
NT1750/150/040Z	€ 7,50	1750 x 150 mm	40
NT1750/150/060Z	€ 6,80	1750 x 150 mm	60
NT1750/150/080Z	€ 6,80	1750 x 150 mm	80
NT1750/150/120Z	€ 6,80	1750 x 150 mm	120
NT2000/050/040Z	€ 4,17	2000 x 50 mm	40
NT2000/050/060Z	€ 3,33	2000 x 50 mm	60
NT2000/050/080Z	€ 3,33	2000 x 50 mm	80
NT2000/050/120Z	€ 3,33	2000 x 50 mm	120
NT2000/150/040Z	€ 13,30	2000 x 150 mm	40
NT2000/150/060Z	€ 11,70	2000 x 150 mm	60
NT2000/150/080Z	€ 11,70	2000 x 150 mm	80
NT2000/150/120Z	€ 11,70	2000 x 150 mm	120



ART	PAG
"A" DRAWER DIVIDERS	417
"B" DRAWER DIVIDERS	417
"C" DRAWER DIVIDERS	418
"GO" SCREW GAUGE	276
"L" HEX SOCKET SPANNER	345
0° ÷ 90° TILTING ROTARY TABLE	148
0° ÷ 90° TILTING TOOL	165
1/2" & 1/4" DR. SOCKET SET	348
1/2" DR. 6 POINT SAE SOCKET SET	347
1/2" DR. SOCKET SET	347
1/4" & 1/2" DR. SOCKET SET	348
1/4" DR. 6 POINT SAE SOCKET SET	346
1/4" DR. DRILL BIT HOLDER SET	232
1/4" DR. SOCKET SET	346
1/4" DR. SPINNER HANDLE	335
1/4" DRIVE DIAMOND CORE DRILL BIT SET	230
1/4 SHANK MAGNETIC HANDLE	366
1/4", 3/8" & 1/2" DR. SOCKET SET	349
1/4" L-SHAPED DRIVER	365
1/4-1/2 BSF THREAD REPAIR F-COIL SET	249
1/4-1/2 BSW THREAD REPAIR F-COIL SET	249
1/4-1/2 UNC THREAD REPAIR F-COIL SET	250
1/4-1/2 UNF THREAD REPAIR F-COIL SET	251
1 1/4" OILER	462
1 1/4" REVERSIBLE AIR SCREWDRIVER	458
1 1/4", 3/8", 1/2" DRIVE QUICK-RELEASE RATCHETS	335
10 + 1 LED MAGNETIC WORK LIGHT	488
10 PC SCREWS SET	185
10" WOOD BAND SAW	089
10" WOOD LATHE	077
10.5" HAND RIVETER	372
10.5" HAND RIVETER SET	372
10PC BAG SET	111
10-PC MOUNTED GRINDING SET	538
10PC PAPER BAG SET FOR VACUUM CLEANER	111
10-PC PAPER CUTTER BLADE SET	389
10W LED FLOODLIGHT WITH MOTION AND BRIGHTNESS SENSOR	484
10W LED FLOODLIGHT WITH STAND	483
10W LED FLOODLIGHT WITH TRIPOD	484
12 + 1 LED POCKET TORCH LIGHT WITH MAGNET	488
12" PLANER & THICKNESSER	080
12 V - 2 A INTELLIGENT DIGITAL BATTERY CHARGER	125
12 V - 8 A INTELLIGENT DIGITAL BATTERY CHARGER	125
12 V ELECTRIC WINCH - DIRECT CURRENT	123
12 V ELECTRIC WINCH - DIRECT CURRENT	124
12" WOOD LATHE	077
120 PCS ALUMINUM NUT RIVET SET	399
12V DC DIESEL PUMP	481
13 GAUGE SEAMLESS POLYESTER GLOVE / NITRILE	500
1300 W INFRARED HEATER WITH SUPPORT FOR WALL MOUNTING	482
13-GAUGE SEAMLESS GLOVE WITH DYNEEMA® + LYCRA® / POLYURETHANE	500
14" WOOD BAND SAW	089
150 PCS CARBON STEEL NUT RIVET SET	398
150 PCS STAINLESS STEEL NUT RIVET SET	399
15-GAUGE SEAMLESS NYLON-ELASTANE GLOVE / NITRILE FOAM	500
1800 W INFRARED HEATER WITH SUPPORT FOR WALL MOUNTING	482
2 - WAY CROSS VICE	146
2 - WAY CROSS VICE WITH SWIVEL BASE	146
2 DOOR TALL CABINET	410
2 FLUTE STRAIGHT SHANK END MILL	236
2 IN 1 AIR STAPLER AND BRAD NAILER	453
2 IN 1 CREEPER AND SEAT	128

ART	PAG
2 IN 1 SPINDLE MOULDER AND SPINDLE SANDER	082
2 IN 1 TOOL ROLLING BOX	420
2 JAW GEAR PULLER	357
2 PC CAR RAMPS SET	124
2 PCS SET GERMAN TYPE FEMALE PLUG	468
2 PCS SET HARD-METAL POINT	114
2 STEEL ARMS PENDING	134
2000 W INFRARED HEATER WITH SUPPORT FOR WALL MOUNTING	482
20W 600/1450 LM RECHARGEABLE LED FLOODLIGHT	491
24 + 3 LED MAGNETIC LIGHT	489
24 LED MAGNETIC LIGHT	489
2-BIT SET FOR CALIPER C010/200	070
2PC BICYCLE LED LIGHT SET	487
2-PC PLASTIC PROTECTIONS	134
2-PC SET MAGNETIC QUICK PLANER KNIFE SETTING JIG	081
2-PCS BLADE SET	391
3 HOLE MAGNETIC SPRAY CANS AND 7 SCREWDRIVERS HOLDER	436
3 IN 1 DRILLING - TAPPING - DEBURRING M3 TOOL	243
3 IN 1 DRILLING - TAPPING - DEBURRING TOOL	243
3 IN 1 DRILLING-TAPPING-DEBURRING TOOL AND BIT SET	243
3 IN 1 DRILLING-TAPPING-DEBURRING M4 TOOL	243
3 IN 1 DRILLING-TAPPING-DEBURRING M6 TOOL	243
3 IN 1 DRILLING-TAPPING-DEBURRING M8 TOOL	243
3 IN 1 DRILLING-TAPPING-DEBURRING TOOL M5	243
3 IN 1 QUICK CHANGE DRIVE RATCHET HANDLE	334
3 JAW GEAR PULLER	357
3 PC ALUMINUM CASE SET	420
3 PC KNIVES SET	081
3 PC STEEL CASE SET	420
3 SOFT JAWS SET	160
3 SOLID SOFT JAWS SET	160
3/4" DR. SOCKET SET	348
3/8" AND 1/4" DR. SOCKET SET	347
3/8" BIT SET AND 3/8"-1/2" SOCKET	368
30 + 7 LED MAGNETIC LIGHT	489
3PC INLET SPONGE FILTER SET	111
3PC INLET SPONGE FILTER SET FOR VACUUM CLEANER	111
3PC PLASTIC TUBE SET	111
3-WAY SPEEDY HEX KEY WRENCH SET	325
4 FEET SET	168
4 FLUTE STRAIGHT SHANK END MILL	236
4 FLUTE STRAIGHT SHANK ROUGHING END MILL	236
4 JAW INDEPENDENT CHUCK	159
4 JAW SELF-CENTERING CHUCK	078
4 POSITIONS ADJUSTABLE LOCK WRENCH	377
4 SOFT JAWS SET	160
4 SOLID SOFT JAWS SET	160
45° BENT NOSE PIPE WRENCH	378
45° EXTERNAL TOOL HOLDER	176
48 LED MAGNIFIER LAMP	485
4-WAY CLAMPING SYSTEM	450
5 BUSHING SET	184
5 CARBIDE BASE 16MM	185
5 CARBIDES	185
5 ITALIAN AND GERMAN TYPE POWER SOCKET AND ITALIAN PLUG 16A	493
5 RHOMBIC BASES 11 MM	184
5 SQUARE BASE 12MM	184
5" AIR ANGLE DIE GRINDER	459
500 CC HAND OPERATED LEVER GREASE GUN	475
58 BLADE SCREW PITCH GAUGE SET	285
5-PC 1/4" CONNECTION HSS SCREW EXTRACTOR SET	357
5PCS MILL SCREWS	190
6 - 12 V - 4 A INTELLIGENT DIGITAL BATTERY CHARGER	125

ART	PAG
6" AIR ORBIT SANDER WITH SELF-INTEGRATED SUCTION	461
6" AIR ORBIT SANDER WITH SUCTION	461
6 ITALIAN AND GERMAN TYPE POWER SOCKET AND ITALIAN PLUG 16A	493
6 ITALIAN AND GERMAN TYPE POWER SOCKET, WITH OVERLOAD PROTECTION AND GERMAN PLUG	493
6 WHEELS CAR CREEPER	128
60L 2 MOTORS WET AND DRY VACUUM CLEANER	110
6G "GO" ISOMETRIC SCREW GAUGE	276
6H "GO" & "NO GO" ISOMETRIC THREAD PLUG GAUGE	276
7 DRAWERS ROLLER CABINET	422
7 DRAWERS ROLLER CABINET WITH TOOLS	425
7 LED POCKET TORCH LIGHT	488
7-PC COUNTERBORER WITH SOLID PILOT STRAIGHT SHANK	234
8 FUNCTIONS COMBINE MACHINE	079
80L 2 MOTORS INDUSTRIAL WET AND DRY VACUUM CLEANER	110
80L 3 MOTORS INDUSTRIAL WET AND DRY VACUUM CLEANER	110
9" EPOXY SEAL CAUL KING GUN	495
9" EPOXY SEAL CAUL KING GUN	496
9" HEAVY DUTY CAULKING GUN	495
9" RATCHET CAUL KING GUN BARREL TYPE	495
9" REINFORCED CAUL KING GUN SKELETON TYPE EXAGONAL ROD	495
90° AIR DIE GRINDER	460
90° BENT NOSE PIPE WRENCH	378
90° BLOCK AND CLAMP	286
90° EXTERNAL TOOL HOLDER	175
90° MAGNETIC SQUARE	283
90° SQUARE	281
90° SQUARE	282
90° THREE FLUTE COUNTERSINK SET	238
90° THREE FLUTES COUNTERSINK	237
93° EXTERNAL TOOL HOLDER	176
95° EXTERNAL TOOL HOLDER	175
ABRASIVE BELTS	575
ABRASIVE CLOTH WHEELS	551
ABRASIVE NYLON BLACK CLEANER	558
ABRASIVE NYLON DISCS	558
ABRASIVE NYLON WIRE WHEELS	553
ABRASIVE RUBBER BLOCKS	561
ABRASIVE WHEELS	567
ABS TOOL CASE	443
ADAPTER	337
ADAPTER	340
ADAPTER	343
ADAPTER	344
ADAPTER FROM SHAFT 3MM TO 6MM	549
ADDITIONAL TOOLS SERIES FOR AUTOMOTIVE IN FOAM TRAY	435
ADJUSTABLE ANGLE PLATE	153
ADJUSTABLE AUTOMATIC WIRE STRIPPER	396
ADJUSTABLE HEIGHT ROLLER STAND	061
ADJUSTABLE HEIGHT TRIPOD	483
ADJUSTABLE LOCK WRENCH	377
ADJUSTABLE SAFETY LANYARD	502
ADJUSTABLE TAILSTOCK	149
ADJUSTABLE TAP HOLDER	243
ADJUSTABLE WRENCHES	321
AIR BELT SANDER	460
AIR BRAD NAILER	453
AIR BRAD NAILER	454
AIR BRADDER FOR MINI PINS	453
AIR BRADDER FOR MINI PINS	454
AIR CLEAN	477

ART	PAG
AIR DIE GRINDER	459
AIR DIE GRINDER	460
AIR DIE GRINDER SET	459
AIR IMPACT WRENCH	455
AIR IMPACT WRENCH	456
AIR IMPACT WRENCH	457
AIR IMPACT WRENCH SET	457
AIR OPERATED GREASE GUN	475
AIR PALM NAILER	454
AIR RATCHET WRENCH SET	458
AIR STAPLER	453
ALLOY TOOL STEEL TAPS AND DIE METRIC SET	241
ALUMINIUM CASE SET	420
ALUMINIUM AND PLASTIC CARBIDE TIPPED SAW BLADE	258
ALUMINIUM CROSS WORKING TABLE	152
ALUMINIUM CROSS WORKING TABLE	153
ALUMINIUM LEVER ACTION HAND PUMP	480
ALUMINIUM MAGNETIC JAW PAIR	449
ALUMINIUM MAGNETIC JAW PAIR WITH FIBER FACE	450
ALUMINIUM MAGNETIC JAW PAIR WITH RUBBER FACE	449
ALUMINIUM OXIDE CLOTH BELTS	552
ALUMINIUM OXIDE CLOTH WHEELS WITH HOLE	550
ALUMINIUM OXIDE SHAFT-MOUNTED CLOTH WHEELS	549
ALUMINIUM TOOL CASE	443
ALUMINUM CASE	420
ALUMINUM HAND TORCH WITH 1 LED AND MANUAL ZOOM	489
ALUMINUM HAND TRUCK WITH PNEUMATIC WHEELS	132
ALUMINUM MAGNETIC JAW COUPLE	449
ALUMINUM NOZZLE OIL GUN	481
ALUMINUM RAMPS	124
ALUMINUM ROTARY HAND OIL PUMP	480
ALUMINUM TORCH	488
ALUMINUM WHITE LED FLASHLIGHT WITH EXTRA BRIGHTNESS	488
ANATOMIC PLASTIC FILE HANDLE	386
ANGLE BLOCK	286
ANGLE PRECISION VICE	142
ANTI WASTE ROLLS	571
ANTI-WASTE SPONGE ROLLS	571
ANVIL FOR CONCRETE TEST HAMMER SETTING	300
ARBOR ADAPTER FOR HOLE SAWS	225
ARBOR FOR HOLE CUTTERS FOR MANSONRY	227
ARBOR FOR MILLING CUTTER	164
ARBOR FOR MILLING CUTTERS	162
ARBOR FOR MILLING CUTTERS	164
AUTO RE-ENTERING CABLE REEL	492
AUTO REPAIRING PLIERS SET	376
AUTO REWIND AIR HOSE REEL	468
AUTO REWIND AIR HOSE REEL	469
AUTOLEVELLING LASER LEVEL	287
AUTOMATIC CABLE REEL WITH LAMP HOLDER	492
AUTOMATIC CENTER PUNCH	383
AUTOMATIC DIESEL GUN	481
AUTOMATIC LOCK WRENCH	378
AUTOMATIC PRECISION BORING HEAD	169
AUTOMATIC SNAP-OFF UTILITY KNIFE BLADES INCLUDED	388
AUTOMATIC SNAP-OFF UTILITY KNIFE, BLADES INCLUDED	389
AUTOMOTIVE CIRCUIT TESTER	293
AXE WITH FIBRE-GLASS HANDLE	397
BACKING PAD	570
BACKING PAD FOR LAMBS WOOL DISCS	565
BACKING PAD WITH VENTILATION	570
BACKING PADS	567
BACKING PADS FOR ORBITAL SANDERS	570



ART	PAG
BACKING PADS WITH FOAM	570
BACKING PADS WITHOUT FOAM	570
BALL POINT HEX KEY SET , LONG TYPE	323
BASE	184
BASE	185
BASE	190
BASE BRACKET SCREW KIT	184
BATTERIES FOR DIGITAL INSTRUMENTS	402
BATTERY AND CHARGING SYSTEM TESTER	293
BELT AND DISC SANDER	092
BELT OIL FILTER WRENCH	329
BENCH CHAMFERING MACHINE	070
BENCH GRINDER	065
BENCH GRINDER SAFETY GUARD WITH LEXAN SCREEN	173
BENCH GRINDER WITH BELT	065
BENCH GRINDER WITH BRUSH	065
BENCH LATHE	022
BENCH LATHE	023
BENCH LATHE	024
BENCH LATHE STAND	023
BENCH LATHE STAND	025
BENCH LATHE WITH INVERTER	022
BENCH MICRO CLEANER	108
BENCH PART WASHER	107
BENCH SANDBLAST	102
BENCH SANDBLAST CABINET	102
BENCH SANDBLAST CABINET	103
BENDING MACHINE	073
BENT NOSE DIAMOND NEEDLE FILE SET	385
BENT NOSE PLIERS	374
BENT NOSE PLIERS 45°	373
BENT NOSE PLIERS 45°	375
BEVEL BRUSHES	554
BEVEL BRUSHES WITH SHAFT	556
BEVEL SQUARE	282
BIG BRUSH FOR VACUUM CLEANER	111
BI-HEXAGONAL HAND SOCKET SET IN FOAM TRAY	433
BIKE/POCKET LED FLASHLIGHT SET	487
BI-METAL BLADE FOR METAL	258
BI-METAL HACK SAW BLADE	393
BIMETAL HOLE SAWS WITH VARIABLE TEETH	223
BI-METAL HSS M3 HOLE SAW VARIABLE TEETH	224
BIT HOLDER	366
BIT SET	366
BIT SET	367
BIT SET	369
BLADE	092
BLADE ADAPTER	092
BLADE FOR WOOD	258
BLADE SET	074
BLADES FOR WOOD	258
BLADES SET	092
BLIND HOLE THREE POINT INSIDE MICROMETER	273
BLIND HOLE THREE POINT INSIDE MICROMETER SET	273
BLOCK FOR VELCRO DISCS	571
BLOW GUN	463
BLOW GUN	464
BODY HARNESS	503
BOLT CUTTER	396
BOLT REMOVER SET	357
BORE GAUGE SET WITH DIAL INDICATOR	270
BORON CARBIDE NOZZLE	106
BOTTLE JACK	129
BOW HANDSAW FOR WOOD	393
BRAD POINT WOODWORKING DRILLS	231
BRAD POINT WOODWORKING DRILLS SET	231

ART	PAG
BRAKE CLEANER, CARBURETORS AND THROTTLE BODIES	478
BRASS STEEL WIRE WHEELS	553
BRICKLAYING TROWEL ROUND NOSE	496
BRICKLAYING TROWELS ROUND NOSE	496
BRIX REFRACTOMETER	298
BSF F-COIL STI TAP	256
BSF THREAD REPAIR F-COIL SET	250
BSP F-COIL STI 2PCS TAPS	256
BSP THREAD REPAIR F-COIL SET	250
BSW F-COIL STI TAP	256
BSW THREAD REPAIR F-COIL SET	249
'C' NOSE AUTOMATIC LOCK WRENCH	378
C50 HARDENED STEEL ANVIL	452
CABINET	417
CABLE HOIST	133
CABLE REEL	492
CABLE REEL	493
CABLE WIRE STRIPPER	396
CAMP AXE	397
CAMP AXE WITH FIBRE-GLASS HANDLE	397
CANADIAN BOOT MADE OF TEFAPRENE	509
CANADIAN BOOT MADE OF TEFAPRENE,	509
CAR EMERGENCY DIGITAL TIRE GAUGE	462
CAR FUSE SET	402
CARBIDE BASE LEFT TOOL	184
CARBIDE BASE RIGHT TOOL	184
CARBIDE ROTARY BURRS	542
CARBIDE ROTARY FILE SET	546
CARBIDE TIPPED DEAD CENTER	155
CARBIDE TIPPED HAMMER TWIST DRILL AND CHISEL SET	227
CARBIDE TIPPED HOLE CUTTER SET FOR MASONRY	228
CARBIDE TIPPED HOLE CUTTERS FOR MASONRY	227
CARBIDE TIPPED LATH E TOOL SET	205
CARBIDE TIPPED PILOT DRILL FOR HOLE CUTTERS FOR MASONRY	227
CARBIDE TIPPED ROUTER BIT SET	239
CARBIDE TIPPED SDS PLUS SHANK TYPE HAMMER TWIST DRILL	226
CARBIDE TIPPED TOOL FOR BLIND HOLES	205
CARBIDE TIPPED TOOL FOR CUTTING OFF	206
CARBIDE TIPPED TOOL FOR EXTERNAL THREAD	205
CARBIDE TIPPED TOOL FOR FACING	205
CARBIDE TIPPED TOOL FOR INTERNAL SLOTS	205
CARBIDE TIPPED TOOL FOR INTERNAL THREAD	205
CARBIDE TIPPED TOOL FOR OUTSIDE ROUGHING	206
CARPENTER PINCER	377
CARPENTER TRY SQUARE	282
CART WITH WOODEN SHELF	131
CARTRIDGE ROLLS	574
CARVING CHISEL SET	384
CARVING KNIFE SET	392
CAST IRON ANVIL	452
CBN WHEEL	069
CENTER DRILL	218
CENTER DRILL	221
CENTER DRILL	222
CENTER DRILL SET	218
CENTER PUNCH	382
CENTRIFUGAL EXPANDING WHEEL	553
CERAMIC BELTS	552
CERAMIC MINI FLAP DISC	547
CERAMIC NOZZLE SET	106
CHAIN HOIST	132
CHAIN SLINGS	134
CHIPPING HAMMER	380

ART	PAG
CHISEL FOR METAL	382
CHISEL SET FOR METAL	383
CHISEL SET FOR WOOD	384
CHROMED METAL JOINTED TUBE FOR REFRIGERATING LIQUIDS	173
CHROMED OUTSIDE MICROMETER	272
CHROMED OUTSIDE MICROMETER	273
CHROMED VERNIER CALIPER	263
CHROMED VERNIER CALIPER	264
CHROMED VERNIERE DEPTH GAUGE	264
CHUCK FOR LATHE	078
CHUCK HOLDER	165
CIRCLIP PLIERS	376
CIRCUIT TESTER SCREWDRIVER	293
CIRCULAR BRUSHES	554
CIRCULAR BRUSHES WITH SHAFT	555
CIRCULAR SAW BENCH EQUIPPED WITH CARBIDE TIPPED SAW BLADE	084
CLA W HAMMER	379
CLAMPING KIT	154
CLAMPING SET	154
CLAW HAMMER ITALIAN TYPE	380
CO-AX INDICATOR	271
COB LED TECHNOLOGY RECHARGEABLE LAMP	490
COLD GALVANIZER	476
COLLET CHUCK	166
COLORLED HEX KEY SERIES	323
COLORLED TORX KEY SERIES	326
COMBINATION PLIERS	311
COMBINATION PLIERS	373
COMBINATION PLIERS	375
COMBINATION SPANNER	318
COMBINATION SPANNER SET	315
COMBINATION SPANNER SET IN FOAM TRAY	430
COMBINATION SPANNER SET IN FOAM TRAY	434
COMBINATION WRENCHES	307
COMBINED BENCH GRINDER	064
COMBINED PLANER AND THICKNESSER	080
COMBINED PLANER AND THICKNESSER	081
COMPOSITE NOZZLE	106
CONCRETE TEST HAMMER	300
CONICAL FELT DISC	563
CONNECTING PLATE AND SCREW ASSORTMENT	401
CONTACT AND OPTICAL TYPE DIGITAL TACHOMETER	297
CONTACT TYPE DIGITAL TACHOMETER	297
COOLING HOSE	172
COOLING SYSTEM FOR MACHINES	172
COPING END MILL	189
COPING END MILLL	189
COPPER GREASE	477
COPPER TUBE BENDER	075
COPPER TUBE CUTTER	395
COPPER WASHER SET	399
COPY DEVICE FOR WOOD LATHE	077
CORNER FOR WORKSHOP MODULAR FURNITURES	406
CORNER SLIDES	414
CORRUGATED DISCS	565
COTTER PIN SET	399
COUNTERBORER WITH SOLID PILOT STRAIGHT SHANK MEDIUM TYPE	234
COUNTERSINK SET WITH HEX SHANK	238
COUNTERSINK WITH HEX SHANK	238
COUPLE JACK STAND	121
COUPLE OF SUPPORTS	168
COW GRAIN LEATHER GLOVE	498
COW GRAIN/SPLIT LEATHER GLOVE	498
CRIMPING PLIER AND WIRE STRIPPER	376

ART	PAG
CRIMPING PLIERS FOR END SLEEVES TERMINALS	375
CROSS BITS PH	370
CROSS BITS PH	371
CROSS BITS PH ANTI SLIP	370
CROSS BITS PZ	370
CROSS BITS PZ	371
CROSS BITS PZ ANTI SLIP	370
CROSS FEED MOTOR	172
CROSS RIM WRENCH	330
CROSS SCREWDRIVER PH WITH DIAMOND TIP	360
CROSS SCREWDRIVER PH, HANGING PACKAGE	361
CROSS SCREWDRIVER PH, HANGING PACKAGE	362
CROSS SCREWDRIVER PZ WITH DIAMOND TIP	360
CROSS SCREWDRIVER PZ WITH DIAMOND TIP	361
CROSS SCREWDRIVER PZ, HANGING PACKAGE	362
CROSS WORKING TABLE	151
CROSS WORKING TABLE	152
CROSSTIP (PH) SCREWDRIVERS	309
CROSSTIP SCREWDRIVER SET IN FOAM TRAY	432
CROSSTIP SCREWDRIVER SET WITH DIAMOND TIP IN FOAM TRAY	432
CRYSTAL LENS	486
CRYSTAL LENS SET	486
CUP BRUSHES	554
CUP BRUSHES WITH SHAFT	556
CUT-OFF MACHINE	062
CUTTING INSERTS	204
CUTTER HEAD SET FOR MACHINE	239
CUTTER HOLDERS	393
CUTTING BAND SAW	060
CUTTING INSERTS	204
CUTTING OIL	477
CYCLONE FILTER	105
CYCLONE FOR SAND BLAST CABINET	104
DEAD BLOW Mallet	381
DEAD BLOW NYLON Mallet	381
DEAD BLOW RUBBER Mallet	380
DEBURRING TOOL WITH 1 BLADE	390
DEBURRING TOOL WITH 2 BLADE	390
DEEP 12 POINT HAND SOCKET	341
DEEP 6 POINT HAND SOCKET	336
DEEP 6 POINT HAND SOCKET	338
DEEP 6 POINT HAND SOCKET	341
DEEP IMPACT HEX SOCKET SET WITH PLASTIC SLEEVE	353
DEEP IMPACT SOCKET	349
DEEP IMPACT SOCKET	351
DEEP IMPACT SOCKET	352
DEGREASER CLEANING PNEUMATIC TANK	108
DEGREASER CLEANING TANK	107
DEGREASER CLEANING TANK WITH WHEEL	108
DE-OXIDIZING AGENT FOR ELECTRIC CONTACTS	478
DEPTH MICROMETER	273
DETACHABLE CROSS RIM WRENCH	330
DETERGENT LIQUID	108
DIAGONAL CUTTING NIPPERS	311
DIAGONAL SIDE CUTTING NIPPERS	373
DIAGONAL SIDE CUTTING NIPPERS	374
DIAGONAL SIDE CUTTING NIPPERS	375
DIAL DEPTH GAUGE	271
DIAL GAUGE STAND	280
DIAL INDICATOR	268
DIAL INDICATOR	269
DIAL INDICATOR HOLDER	277
DIAL INSIDE GAUGE	270
DIAL INSIDE GAUGE	271
DIAL TEST INDICATOR	269
DIAL TEST INDICATOR	270



ART	PAG	ART	PAG
DIAL TEST INDICATOR WITH LONG CONTACT POINT	269	DOUBLE OPEN END MIRROR POLISH LONG PATTERN WRENCH SET	315
DIAL THICKNESS GAUGE	270	DOUBLE OPEN END WRENCH	317
DIAMOND CUP WHEEL	539	DOUBLE OPEN END WRENCH SET	317
DIAMOND CUT ROTARY BURRS	541	DOUBLE RATCHET HAND PULLER	136
DIAMOND CUT ROTARY BURRS	542	DOUBLE X LONG REACH PLIER	373
DIAMOND CUT ROTARY BURRS	543	DOUBLE X LONG REACH PLIER LONG BENT NOSE 45°	373
DIAMOND CUT ROTARY BURRS	544	DOUBLE X LONG REACH PLIER LONG NOSE	373
DIAMOND CUT ROTARY BURRS	545	DOUBLE-CROSSTIP (PZ) SCREWDRIVERS	310
DIAMOND CUT ROTARY BURRS	546	DRAWER RACK WITH LOCK	415
DIAMOND DRILL BIT AND CORE DRILL WITH CONTINUOUS EDGE SET	228	DRAWER UNITS WITH TRANSPARENT PULL-OUT DRAWERS	418
DIAMOND DRILL BIT AND CORE DRILL WITH CONTINUOUS EDGE SET	229	DRIFT PIN	382
DIAMOND DRILL BIT SET WITH CONTINUOUS EDGE	230	DRIFT PIN SET	382
DIAMOND DRILL BITS AND CORE DRILLS WITH CONTINUOUS EDGE	228	DRIFT PIN SET IN FOAM TRAY	434
DIAMOND DRILL BITS WITH CONTINUOUS EDGE	229	DRIFT PIN SET WITH HAMMER IN FOAM TRAY	434
DIAMOND DRILL BITS WITH CONTINUOUS EDGE	230	DRIFT PIN SET WITH PLASTIC HOLDER	382
DIAMOND FLAT FILE	385	DRIFT SLEEVES	156
DIAMOND MOUNTED POINT AND DISC SET	238	DRILL BIT	225
DIAMOND MOUNTED POINT SET	238	DRILL PRESS VICE	145
DIAMOND NEEDLE FILE SET	385	DRILL PRESS WITH DRIVE BELT	053
DIAMOND SAW BLADES CONTINUOUS RIM	539	DRILL PRESS WITH DRIVE BELT	054
DIAMOND TIP SCREWDRIVER SET	361	DRILL PRESS WITH DRIVE BELT	055
DIAMOND WHEEL	069	DRILL PUMP	481
DIE GAS THREAD	244	DRILL SUCTION CUP WITH ADJUSTABLE HOLE FRAME	230
DIGITAL ANEMOMETER	296	DRILL SUCTION CUP WITH GUIDING HOLES	230
DIGITAL ANGLE FINDER AND LEVEL WITH 2 VIALS	290	DRILLING MACHINE	044
DIGITAL CLAMP METER	292	DRILLING MILLING MACHINE	038
DIGITAL COATING THICKNESS GAUGE FOR FERROUS AND NON-FERROUS BASES	298	DRY BRUSH FOR VACUUM CLEANERS	111
DIGITAL DIAL THICKNESS GAUGE	270	DRY PT FE LUBRICANTING AGENT	477
DIGITAL DYNAMOMETERS	302	DUST COLLECTOR	094
DIGITAL HOT AIR GUN SET	472	DUST PROOF ERGONOMIC RATCHET HANDLE	334
DIGITAL LEVEL	288	E SOCKET SET	345
DIGITAL LEVEL - INCLINOMETER AND GONIOMETER WITH MAGNET	288	EARPLUGS WITH BOW	505
DIGITAL LEVEL BOX	289	ECCENTRIC BENCH TESTER	280
DIGITAL LEVEL WITH LASER	288	E-CLIP SET	399
DIGITAL LUXMETER	296	ELECTRIC BARBECUE LIGHTER	472
DIGITAL MULTI-FUNCTION SENSOR	297	ELECTRIC CHAINSAW SHARPENER	067
DIGITAL MULTIMETER	292	ELECTRIC ENGRAVER	113
DIGITAL MULTIMETER	293	ELECTRIC RADIANT INFRARED HEATER WITH STAND	482
DIGITAL PRESSURE GAUGE	462	ELECTRIC SLIP ROLLING MACHINE	071
DIGITAL ROUGHNESS TESTER	300	ELECTRIC VIBRATING ENGRAVER	114
DIGITAL TORQUE SCREWDRIVER	331	ELECTRICIAN FLAT SCREWDRIVER WITH DIAMOND TIP	360
DIGITAL TORQUE WRENCH	331	ELECTRICIAN SCISSORS	394
DIGITAL TORQUE WRENCH FOR WHEEL	330	ELECTRICIAN SCREWDRIVER, HANGING PACKAGE	361
DIGITAL TYRE GAUGE	463	ELECTRICIAN'S SCREWDRIVER	364
DISC MICROMETER	273	ELECTRO-HYDRAULIC ATV & MOTORCYCLE LIFT	126
DISC TYPE GEAR SHAPER CUTTER	235	ELECTRO-HYDRAULIC MOTORCYCLE LIFT	126
DISK BLADE SET	391	ELECTRONIC CUTTING BAND SAW FOR BENCH	060
DISPOSABLE COVERALL WITH HOOD	505	ELECTRONIC DIGITAL MICROMETER	272
DISPOSABLE EARPLUGS IN POLYURETHANE FOAM	505	ELECTRONIC DIGITAL MULTI FUNCTION HEIGHTGAUGE	265
DIVIDER FOR DOT MARKING MACHINE	112	ELECTRONIC DIGITAL SCALE	301
DIVIDING PLATES FOR ROTARY TABLE	148	ELECTRONIC DIGITAL SCALE WITH DOUBLE DISPLAY	301
DOME MOPS	565	ELECTRONIC DIGITAL TORQUE - ANGLE WRENCH	330
DOOR CABINET	410	ELECTRONIC DIGITAL TORQUE WRENCH	331
DOUBLE DEBURRER WITH HSS DISK BLADE	391	ELECTRONIC EDGE FINDER	271
DOUBLE HAND NUT RIVETER	371	EMPTY FOAM TRAY FOR SMALL ITEMS	435
DOUBLE HAND RIVETER	372	EMPTY FOAM TRAY FOR SMALL ITEMS	436
DOUBLE HAND RIVETER WITH ROTATING HEAD	372	EMULSIFYING OIL	476
DOUBLE HEAD SCREWDRIVER BIT SET	365	END BRUSHES	556
DOUBLE HEAD SOCKET WRENCH SET	321	END CUTTING NIPPERS	374
DOUBLE JOINT LONG PLIER SET	373	END TERMINAL SET	402
DOUBLE OPEN END MIRROR POLISH LONG PATTERN WRENCH	315	ENGINE STAND	122
		ENGINE SUPPORT	122
		ENGINEER' S SCRIBER WITH METAL BODY AND HARD-METAL POINT	113

ART	PAG
ENGINEER' S SCRIBER WITH METAL BODY AND HARD-METAL POINT	114
ENVIRONMENTAL OR IMMERSION THERMOCOUPLE "K" TYPE	295
ENVIRONMENTAL TEMPERATURE AND HUMIDITY DIGITAL TESTER	296
ENVIRONMENTAL THERMOCOUPLE "K" TYPE	295
ER16 SPRING COLLET SET	166
ER20 SPRING COLLET SET	167
ER25 SPRING COLLET SET	167
ER32 SPRING COLLET SET	167
ERGONOMIC RATCHET HANDLE	334
ERGONOMIC RATCHET HANDLE	335
EXTENDED JAWS	357
EXTENDED MORSE TAPER ADAPTERS	156
EXTENSIBLE DEBURRING TOOL WITH 3 BLADES	390
EXTENSION BAR	337
EXTENSION BAR	340
EXTENSION BAR	343
EXTENSION BAR	344
EXTERNAL LOCK RINGS PLIERS, BENT	313
EXTERNAL LOCK RINGS PLIERS, STRAIGHT	312
EXTERNAL THREAD INSERTS	204
EXTERNAL THREAD TOOL HOLDER	181
EXTERNAL THREAD TOOL HOLDER	182
EXTERNAL TOOL HOLDER	176
EXTERNAL TOOL HOLDER	177
EXTERNAL TOOL HOLDER	178
EXTERNAL TOOL HOLDER WITH INSERTS	175
EXTRA LONG INTERCHANGEABLE SCREWDRIVER SET	362
EXTRA LONG NOSE MINI PLIERS	374
EXTRA LONG TYPE STRAIGHT SHANK TWIST DRILL	213
EXTRA LONG TYPE STRAIGHT SHANK TWIST DRILL	214
EYEGLOSS TEMPLE	502
FACE MILLING	188
FACE MILLING CUTTER	186
FACE MILLING CUTTER	187
FACE MILLING CUTTER	188
FACE MILLING CUTTER	189
FACE MILLING CUTTER	190
FACE MILLING CUTTER FOR BLIND SIDE'S INSERT	187
FACE MILLING CUTTERS	188
FAST HEATING SOLDERING GUN	471
FAST LOCK FELTRO	548
FAST LOCK SURFACE CONDITIONING	547
FAST LOCK UNITIZED	547
FAST LOCK ZIRCONIA TOP SIZE	547
FASTENING SHAFT	558
F-COIL MOUNTING TOOL	257
F-COIL MOUNTING TOOL HEXAGONAL DRIVE	257
F-COIL PULLER	257
F-COIL TANG BREAKING TOOL	257
FEELER	283
FEELER GAUGE SET	284
FEELER GAUGE SET, STAINLESS STEEL	284
FELT DISCS	562
FELT FLAP DISCS	562
FELT FLAP WHEELS	562
FELT POINT	563
FILE SET FOR METAL WITH ANATOMIC HANDLE	385
FILTER BAG	095
FILTER FOR VACUUM CLEANER	111
FINE POLISHED MINI PLIER SET	374
FINGER RATCHET SCREWDRIVERS	366
FIRST AID PRODUCTS	504
FITTER TOOL BAG	445
FITTING WITH 4 DIAMETERS	095

ART	PAG
FIXED GUN	106
FLARE BUFFS	565
FLARE NUT WRENCH SET	321
FLAT DISCS WITH HOLE FOR DRILL	558
FLAT NOSE MINI PLIERS	374
FLAT POINT COLD CHISEL WITH HAND GUARD	383
FLAT POLYGONAL WRENCH	320
FLAT RING SPANNER SET	320
FLAT SCREWDRIVER SET IN FOAM TRAY	431
FLAT SCREWDRIVER SET WITH DIAMOND TIP IN FOAM TRAY	432
FLAT SCREWDRIVER WITH DIAMOND TIP	360
FLAT SCREWDRIVERS	309
FLAT TYPE TOOL HOLDERS	170
FLAT TYPE TOOL HOLDERS	171
FLEXIBLE ARM LAMP	485
FLEXIBLE ARM LAMP WITH MAGNIFYING LENS	485
FLEXIBLE CLOTH	572
FLEXIBLE ENDOSCOPE FOR MECHANICAL USE	291
FLEXIBLE EXTENSION	291
FLEXIBLE HOSE FOR VACUUM CLEANER	111
FLEXIBLE MAGNETIC LED FLASHLIGHT WITH MAGNETIC BASE	356
FLEXIBLE MASK IN NONWOVEN FABRIC	506
FLEXIBLE NUT DRIVER	365
FLEXIBLE NUT DRIVER SET IN FOAM TRAY	433
FLEXIBLE NUT DRIVER SET WITH PLASTIC HANDLE	359
FLEXIBLE NUT DRIVER WITH PLASTIC HANDLE	358
FLEXIBLE OIL-CAN	474
FLEXIBLE PNEUMATIC MICROGRINDING WHEEL	459
FLEXIBLE PROBE	291
FLEXIBLE SHAFT GRINDER	062
FLOOR DRILL PRESS WITH DOUBLE TABLE	049
FLOOR DRILL PRESS WITH DRIVE BELT	046
FLOOR DRILL PRESS WITH DRIVE BELT	047
FLOOR DRILL PRESS WITH DRIVE BELT	049
FLOOR DRILL PRESS WITH DRIVE BELT	050
FLOOR DRILL PRESS WITH DRIVE BELT	051
FLOOR DRILLING MACHINE WITH BELT DRIVE	048
FLOOR DRILLING MACHINE WITH DRIVE BELT	047
FLOOR DRILLING MACHINE WITH DRIVE BELT	048
FLOOR DRILLING MILLING MACHINE	032
FLOOR DRILLING MILLING MACHINE	033
FLOOR DRILLING MILLING MACHINE	037
FOAM BLOCK	561
FOAM PAD	561
FOLDABLE HEAVY DUTY WORKBENCH	414
FOLDABLE UTILITY KNIFE, BLADES INCLUDED	389
FOLDING ANTISLIP PLATFORM	132
FOLDING STAND	061
FOOT CONTROL FOR DOT MARKING MACHINE	112
FOOTBOARDS	414
FORGED STEEL VICE	448
FORGING FURNACE	074
FOUR JAWS ADJUSTABLE LOCK WRENCH	377
FUEL CAN RUBBER GASKET	479
FULLY GROUND FROM THE SOLID	215
FULLY GROUND FROM THE SOLID 135° SPLIT POINT TWIST DRILL	215
FULLY GROUND FROM THE SOLID COBALT TWIST DRILL SET	215
FULLY GROUND FROM THE SOLID COBALT TWIST DRILL SET	216
FULLY GROUND FROM THE SOLID TWIST DRILL	210
FULLY GROUND FROM THE SOLID TWIST DRILL	215
FULLY GROUND FROM THE SOLID TWIST DRILL	216
FULLY GROUND FROM THE SOLID TWIST DRILL SET	210



ART	PAG
FULLY GROUND STRAIGHT SHANK TWIST DRILL SET	210
GARAGE WALL GUARD	124
GARDEN CABLE REEL	493
GAS SOLDERING IRON	471
GAS SPANNER	322
GAUGE BLOCK ACCESSORIES	281
GEAR BENCH LATHE	023
GEAR HEAD LATHE	012
GEAR HEAD LATHE	014
GEAR HEAD LATHE	017
GEAR HEAD LATHE	019
GEAR HEAD LATHE	020
GEAR HEAD LATHE	021
GEAR HEAD LATHE 230 V	015
GEAR HEAD LATHE WITH INVERTER	007
GEAR HEAD LATHE WITH INVERTER	009
GEAR HEAD LATHE WITH INVERTER	016
GEAR HEAD LATHE WITH INVERTER	019
GEAR HEAD LATHE WITH INVERTER	020
GEAR HEAD LATHE WITH READ OUT	006
GEAR HEAD LATHE WITH READ OUT	008
GEAR HEAD LATHE WITH READ OUT	010
GEAR HEAD LATHE WITH READ OUT	012
GEAR HEAD LATHE WITH READ OUT	014
GEAR HEAD LATHE WITH READ OUT	015
GEAR HOB 20° PRESSURE ANGLE	235
GEARED DRILLING MACHINE	045
GEARED DRILLING MACHINE	046
GEARED DRILLING MILLING MACHINE	034
GEARED DRILLING MILLING MACHINE	035
GEARED DRILLING MILLING MACHINE	036
GEARED DRILLING MILLING MACHINE EQUIPPED	035
GEARED DRILLING MILLING MACHINE EQUIPPED	036
GEARED HAND WINCH	136
GEARED MILLING DRILLING MACHINE	033
GEARED MILLING DRILLING MACHINE	034
GENERAL USE STEEL CLAMP RATCHET	451
GENERAL USE STEEL CLAMP WITH T-SPINDLE	450
GENERAL USE STEEL CLAMP WITH T-SPINDLE	451
GLASS FUSE SET	401
GLUE GUN TRIGGER FED	473
GLUE GUN TRIGGER FEED	473
GRANITE INSPECTION PLATE	281
GRANITE SQUARE	281
GRANITE SURFACE STAND WITH TWO DRAWERS	281
GRAVITY FEED SPRAY GUN	465
GRAVITY FEED SPRAY GUN	466
GREASE CARTRIDGE	475
GREASE FITTING SET	402
GRINDFLEX FLAP DISC BIGGER	519
GRINDFLEX FLAP DISC CLASSIC	518
GRINDFLEX FLAP DISC CLASSIC	519
GRINDFLEX FLAP DISC CLASSIC	520
GRINDFLEX FLAP DISC DUAL FLAP	519
GRINDFLEX FLAP DISC DUAL FLAP	520
GRINDFLEX FLAP DISC REAL FLAT	519
GRINDING PASTES	562
GRINDING WHEEL	536
GRINDING WHEEL STAND	066
GRINDING WHEELS	536
GROOVE INSERTS	204
GUN	105
H7 HOLE PLAIN GAUGE SET "GO" & "NO GO"	275
H7 HOLE PLAIN GAUGE WITH "GO" & "NO GO" CHECKS MADE OF HARDENED ALLOY STEEL	275
HACKSAW BLADE	393
HACKSAW FRAME WITH ALUMINUM ALLOY HANDLE	392

ART	PAG
HACKSAW WITH BLADE	392
HALF MOON RING SPANNERS	321
HALF PANEL CONNECTOR	412
HAND BRUSHES	557
HAND NUT RIVETER	371
HAND OPERATED LEVER GREASE GUN	475
HAND OPERATED WINCH WITH BRAKE	136
HAND PUNCH	118
HAND RIVETER	372
HAND RIVETER SET	371
HAND RIVETER WITH MULTI-SIDES BLOCKER	372
HAND SHEAR	074
HAND TRUCK WITH PNEUMATIC WHEELS	132
HANDSAW FOR JOINER WITH TRIPLE DRESSED SHARPENING DIAMOND TYPE	392
HANGING PANEL	411
HARD METAL ROTARY BURR SET	546
HARDENED AND GROUNDED TOOL BITS	206
HARDNESS TESTING MACHINE	300
HEAD LAMP WITH SENSOR	487
HEAD LIGHT WITH MAGNIFYING LEN SET	486
HEADLESS PINS	398
HEAVY DUTY AIR HAMMER WITH 4 HEXAGONAL CHISELS	460
HEAVY DUTY DIAGONAL CUTTING NIPPERS	311
HEAVY DUTY PIPE WRENCH	378
HEAVY DUTY PRY BAR SET	387
HEAVY DUTY STAPLE GUN TACKER	453
HELECTRIC CABLE HOIST	133
HEPA FILTER	111
HEPA FILTER FOR VACUUM CLEANER	111
HEX BIT AND SOCKET SET	368
HEX BIT AND SOCKET SET	369
HEX BIT SET	368
HEX BIT SOCKET	336
HEX BIT SOCKET	339
HEX BIT SOCKET	342
HEX KEY SET	323
HEX KEY SET	325
HEX KEY SET WITH DIAMOND TIP	323
HEXAGONAL BITS	370
HEXAGONAL HAND SOCKET SET IN FOAM TRAY	432
HEXAGONAL HAND SOCKET SET IN FOAM TRAY	433
HEXAGONAL HEAD SCREWDRIVERS WITH T-HANDLE	308
HEXAGONAL IMPACT SOCKET SET IN FOAM TRAY	435
HEXAGONAL PRECISION SCREWDRIVER	364
HEXAGONAL TUBULAR SOCKET AND FLARE NUT WRENCH SET IN FOAM TRAY	434
HEXAGONAL TUBULAR SOCKET WRENCH	322
HEXAGONAL TUBULAR SOCKET WRENCH SET	321
HEXAGONAL TUBULAR SOCKET WRENCH SET	322
HEXAGONAL TUBULAR SOCKET WRENCHES	322
HIGH ACCURACY DIGITAL POCKET SCALE	301
HIGH LIFT TROLLEY	130
HIGH LIFT TRUCK-PALLET	138
HIGH POWERFUL LED TORCH	487
HIGH PRECISION 3 JAWS KEYLESS DRILL CHUCK	157
HIGH PRECISION STEEL MODULAR VICE	143
HIGH PRECISION STEEL VICE	142
HIGH PRECISION TEMPERATURE -CONTROLLED SOLDERING IRON STATION	470
HITCH PIN SET	399
HOIST ARM	133
HOLDER FOR FEELER GAUGE BLADES	285
HOLE CUTTER	222
HOLE CUTTER SHANK WITH COOLANT SYSTEM AND WELDON SHANK	161
HOLE CUTTERS ARBOR	222

ART	PAG
HOLE SAW ARBOR WITH DRILL BIT	225
HOLE SAW SET	223
HOLE SAW SET	224
HOLE SAW SET	225
HOLE SAW SET FOR WOOD	231
HOLLOW NUT DRIVER SET WITH PLASTIC HANDLE	359
HOLLOW NUT DRIVER WITH PLASTIC HANDLE	358
HOLLOW PUNCH SET	395
HOOK AND LOOP PAD	462
HOOK SET	414
HOOKS	421
HOOKS SET	416
HORIZONTAL AND VERTICAL DIRECT DIVIDING HEAD	147
HORIZONTAL AND VERTICAL RATCHET DIVIDING HEAD	147
HORIZONTAL AND VERTICAL ROTARY TABLE	149
HORIZONTAL MAGNETIC DRILL	057
HORIZONTAL ROTARY TABLE	148
HOSE CLIP SET	401
HOSE REELS CABINET	410
HOT AIR GUN	471
HOT AIR GUN SET	472
HOT KNIFE FOR POLYSTYRENE WITH ADJUSTABLE TEMPERATURE	472
HOT KNIFE FOR POLYSTYRENE WITH ADJUSTABLE TEMPERATURE	473
HOT MELT GLUE STICKS	473
HRC 58-60 LETTERS	113
HRC58-60 LETTERS	113
HSS BIDIRECTIONAL BLADE SET	390
HSS HOLE CUTTER SET	222
HSS LONG SHANK BLADE SET	390
HYDRAULIC BODY FRAME REPAIR KIT	119
HYDRAULIC BOTTLE JACK	129
HYDRAULIC FOLDING CRANE	122
HYDRAULIC JACK	121
HYDRAULIC LIFT TABLE	127
HYDRAULIC MOTORCYCLE LIFT TABLE	127
HYDRAULIC PUMP	119
HYDRAULIC PUMP WITH PNEUMATIC PEDAL CONTROL	119
HYDRAULIC RAM	129
HYDRAULIC SHOP PRESS	116
HYDRAULIC SHOP PRESS	117
HYDRAULIC SHOP PRESS	118
HYDRAULIC SHOP PRESS WITH MANUAL PNEUMATIC CONTROL	116
HYDRAULIC TROLLEY JACK	120
HYDRAULIC TROLLEY JACK	121
HYDRAULIC TUBE BENDER 1/2 - 2"	075
HYDRAULIC UNIVERSAL MAGNETIC STAND	279
HYGIENIC MASK	506
I12 V 2 - 6 - 12A INTELLIGENT DIGITAL BATTERY CHARGER	125
IMPACT 6 POINT BIT SOCKET	350
IMPACT ADAPTER	355
IMPACT DRIVER	364
IMPACT EXTENSION BAR	350
IMPACT EXTENSION BAR	351
IMPACT EXTENSION BAR	355
IMPACT HEX BIT SOCKET	350
IMPACT HEX BIT SOCKET SET	353
IMPACT HEX SOCKET SET WITH PLASTIC SLEEVE	354
IMPACT HEX SOCKET WITH PLASTIC SLEEVE	353
IMPACT RIBE BIT SOCKET	350
IMPACT SOCKET SET	355
IMPACT TORX BIT SOCKET	350
IMPACT TORX BIT SOKET SET	353
IMPACT UNIVERSAL JOINT	355

ART	PAG
IMPACT XEX BIT SOCKET	350
IMPACT XZN BIT SOCKET	350
INCH CHROMED STEEL BALL SET	400
INDEXABLE CARBIDE TOOL HOLDER SET	175
INDUCTIVE MOISTURE METER FOR MEASURING HUMIDITY	296
INDUSTRIAL WET AND DRY VACUUM CLEANER EQUIPPED OF ACCESSORIES	109
INFRARED BULB	483
INNER-OUTER REAMER	391
INOX CUTTING DISC	533
INOX SCISSORS	394
INSERTS COUNTER SINKS SET	189
INSIDE CALIPER	285
INSULATED CROSS SCREWDRIVER	363
INSULATED ELECTRICIAN SCISSORS	394
INSULATED SCREWDRIVER SET	363
INSULATED SCREWDRIVER SET IN FOAM TRAY	433
INSULATED SLOT SCREWDRIVER	363
INSULATED TERMINAL SET	402
INTERNAL AND EXTERNAL GROOVING TOOL HOLDER SET	182
INTERNAL LOCK RINGS PLIERS, BENT	313
INTERNAL LOCK RINGS PLIERS, STRAIGHT	313
INTERNAL THREAD INSERTS	204
INTERNAL THREAD TOOL HOLDER	182
INTERNAL TOOL HOLDER	179
INVERTER GEAR HEAD LATHE	011
INVERTER GEAR HEAD LATHE WITH READ OUT	013
INVERTER GENERATOR	494
INVERTER GENERATOR WITH ELECTRIC STARTER AND WHEELS	494
INVERTER GENERATOR WITH WHEELS	494
INVERTER MILLING MACHINE	031
INVERTER VERTICAL MILLING MACHINE	028
IRON BENDER	074
IRON PLANER FOR WOOD	384
KEYLESS CHUCK	156
KEYLESS CHUCK WITH LOCK	156
KIT PARTS	184
KNIFE FOR PLANER	081
KNIFE FOR PLANER	082
KNIFE SET FOR THICKNESSER	082
KNURLING TOOL WITH 3 PAIRS OF KNURLING WHEELS, WITH DIAMOND PATTERN	178
LAMP PROTECTION SET	105
LARGE AMERICAN TOOL CABINET	411
LASER DISTANCE METER	294
LASER METER	294
LASER POINTER INFRARED TEMPERATURE METER	294
LASER POINTER ULTRASONIC DISTANCE METER	294
LASHING SYSTEM WITH POLYESTER RIBBON DRAFT	134
LASHING SYSTEM WITH POLYESTERE RIBBON DRAFT	134
LATEX GLOVE	501
LATEX WATERPROOF ROLLS	572
LATEX WATERPROOF SHEETS	573
LATH E CHUCK SAFETY GUARD STEEL FRAME WITH LEXAN SCREEN	173
LATHE MILL TABLE UNIVERSAL DEVICE	170
LED FLASHLIGHT SET WITH TELESCOPIC MAGNET	489
LED FLOODLIGHT WITH MAGNETIC BASE	484
LED FLOODLIGHTS	483
LED HEADLIGHT	487
LED LICHT MASCHINEN BETRIEBSLAMPE	174
LED LIGHT FOR WORKSHOP MODULAR FURNITURES	412
LED LIGHT MACHINE OPERATION LAMP	174
LED LIGHT POWER SUPPLY	412
LED MAGNIFIER	486



ART	PAG
LEFT HAND AVIATION TIN SNIP	393
LEFT TOOL BRACKET	184
LEVEL	289
LEVER ACTION HAND OIL PUMP	480
LEVER CHAIN HOIST	133
LIFT TROLLEY	130
LINEAR LEVEL	289
LITHIUM GREASE	478
LOCK RING DRIVING KEY	167
LOCK RING PLIER SET IN FOAM TRAY	435
LOCKING L-GRIP CLAMP	377
LONG ARBOR FOR HOLE CUTTERS FOR MANSORNY	227
LONG BIT SET	367
LONG FLAT NOSE PLIERS	312
LONG HEX BIT SOCKET	339
LONG HEX BIT SOCKET	342
LONG HEXAGONAL SOCKET WRENCH	341
LONG IMPACT HEX SOCKET WITH PLASTIC SLEEVE	354
LONG IMPACT SOCKET SET	354
LONG NOSE AUTOMATIC LOCK WRENCH	378
LONG NOSE BLOW GUN	464
LONG NOSE MINI PLIERS	374
LONG NOSE PLIERS	373
LONG NOSE PLIERS	375
LONG NOSE PLIERS WITH SIDE CUTTER AND PIPE GRIP, BENT	312
LONG NOSE PLIERS WITH SIDE CUTTER AND PIPE GRIP, STRAIGHT	311
LONG RIBE BIT SOCKET	339
LONG RIBE BIT SOCKET	342
LONG ROUND NOSE PLIERS	312
LONG TAPE	287
LONG TORX BIT SOCKET	339
LONG TORX BIT SOCKET	342
LONG TWIST DRILLS WELDON SHANK	220
LONG TYPE AIR DIE GRINDER	461
LONG TYPE STRAIGHT SHANK TWIST DRILL	213
LONG TYPE UNIVERSAL HOLE CUTTERS WITH WELDON SHANK	220
LONG TYPE WELDON SHANK CORE DRILL SET	221
LONG XZN BIT SOCKET	340
LONG XZN BIT SOCKET	343
LOW CONSUMPTION LAMP	485
LOW PROFILE 12 POINT SOCKET SET	345
LOW PROFILE GO-THROUGH SPLINE SOCKET SET	346
LOW PROFILE HYDRAULIC TROLLEY JACK	120
LOW PROFILE JACK	120
LOWERED MANUAL PALLET TRUCK	138
LUBRICANT VELCRO PAPER ROLLS	572
M14 DIAMOND DRILL BIT AND CORE DRILL WITH CONTINUOUS EDGE SET	230
M14 DIAMOND DRILL BITS AND CORE DRILLS WITH CONTINUOUS EDGE	229
MACHINE REAMER	233
MACHINE TAP SET FOR BLIND HOLES 35° WITH REINFORCED SHANK	240
MACHINE TAP SET FOR THROUGH HOLES WITH REINFORCED SHANK	240
MACHINE TAPS SPIRAL FLUTE FOR BLIND HOLES 35°	242
MACHINE TAPS SPIRAL FLUTE FOR BLIND HOLES 35°	243
MACHINE TAPS STRAIGHT FLUTE SPIRAL POINTED FOR THROUGH HOLES	242
MACHINE TAPS STRAIGHT FLUTE, SPIRAL POINTED FOR THROUGH HOLES	241
MACHINE TAPS STRAIGHT FLUTE, SPIRAL POINTED FOR THROUGH HOLES	242
MACHINE TOOL OPERATION LAMP	174
MACHINE TOOL SAFETY GUARD	173

ART	PAG
MACHINIST'S HAMMER GERMAN TYPE	379
MAGNETIC BASE	277
MAGNETIC CHUCK	153
MAGNETIC DRILL	056
MAGNETIC DRILL	057
MAGNETIC EXTRACTOR WITH LIGHT	356
MAGNETIC HANGING TRAY WITH SCREWDRIVERS HOLDER	436
MAGNETIC HOLDER FOR IMPACT WRENCH	436
MAGNETIC LEVEL	289
MAGNETIC LIFTER	133
MAGNETIC PRECISION TAPE	287
MAGNETIC SCREWDRIVER WITH 6 BITS	367
MAGNETIC SCREWDRIVERS HOLDER	436
MAGNETIC SOCKETS HOLDER	436
MAGNETIC STAND	277
MAGNETIC STAND	278
MAGNETIC STAND	279
MAGNETIC TAPPING/DRILL	057
MAGNETIC TOOL TRAY SET	436
MAGNETIC VEE BLOCK	286
MAGNIFIER FOR MEASURING	291
MALE "T" HANDLE HEX WRENCHES	324
MALE "T" HANDLE TORX WRENCH	327
MALE "T" HANDLE TORX WRENCH SET	327
MALE HEX KEY SET	325
MALE "T" HANDLE HEX WRENCH	324
MALE "T" HANDLE HEX WRENCH SET	324
MALE T-HANDLE HEX WRENCH SET IN FOAM TRAY	430
MALE T-HANDLE TORX WRENCH SET IN FOAM TRAY	430
MALLET	380
MANUAL GRINDER FOR SAW BLADE	068
MANUAL LOG SPLITTER	093
MANUAL STACKER	139
MANUAL TRUCK -PALLET	138
MASK IN NONWOVEN FABRIC	506
MASK IN NONWOVEN FABRIC WITH ACTIVE CARBONS	506
MASONRY DRILL	226
MEASURING INSTRUMENTS FOR AUTOMOTIV IN FOAM TRAY	435
MEASURING JUG	474
MECHANIC CHISEL, PIN PUNCH AND CENTER PUNCH SET WITH HAND GUARD	383
MECHANIC CHISEL, PIN PUNCH AND CENTER PUNCH SET WITH PLASTIC HOLDER	383
MECHANICAL EDGE FINDER	271
METAL BAND SAW	060
METAL BAND SAW WITH MANUAL AND HYDRAULIC FEED	059
METAL DETECTOR	297
METAL EXTENSION PIPE FOR VACUUM CLEANER	111
METAL FUEL TANK	479
METAL POURING SPOUT	479
METRIC CHROMED STEEL BALL SET	400
METRIC COMBINED TAP FOR SOLID INSERT	248
METRIC DIE COARSE PITCH	244
METRIC F-COIL 2 PCS STI TAPS	255
METRIC F-COIL STI COMBINED TAP	255
METRIC F-COIL STI TAP	255
METRIC GAUGE BLOCK SET	274
METRIC GLOW PLUG SOLID THREAD REPAIR SET	249
METRIC SPARK PLUG SOLID THREAD REPAIR SET	248
METRIC STANDARD IMPACT SOCKET SET	354
METRIC THREAD REPAIR F-COIL SET	245
METRIC THREAD REPAIR F-COIL SET	246
METRIC THREAD REPAIR F-COIL SET	247
MICRO FLAP WHEELS	549
MICRO GLASS BEADS	104

ART	PAG
MICROMETER STAND	281
MILL SCREW 040/063	190
MILL SCREW 080/125	190
MILLING CUTTER WITH NEGATIVE INSERTS FOR FACE MILLING	188
MILLING DRILLS	218
MILLING INSERTS	201
MILLING INSERTS	202
MILLING INSERTS	203
MILLING MACHINE	032
MILLING MACHINE VICE WITH 360° SWIVEL BASE	143
MILLING MACHINE VICE WITH 360° SWIVEL BASE	144
MINI AIR DIE GRINDER	460
MINI BENCH SANDBLAST	103
MINI CUP FLAP DISC	547
MINI FLAP DISC	547
MINI HACKSAW WITH BLADE	392
MINI HAND BRAKE	071
MINI HAND ROLL FORMING MACHINE	071
MINI HAND SHEAR BRAKE	071
MINI LASER LEVEL	288
MINI LATHE	024
MINI MAGNETIC STAND	280
MINI SPRAY GUN	466
MINI WELDING HOLDER	283
MIRROR POLISH LONG PATTERN COMBINATION SPANNER	316
MIRROR POLISH LONG PATTERN COMBINATION SPANNER	317
MIRROR POLISH LONG PATTERN COMBINATION SPANNER SET	316
MIRROR POLISH LONG PATTERN COMBINATION SPANNER SET	317
MITRE SAW	085
MITRE SQUARE	282
MIXED NONWOVEN AND CLOTH WHEELS WITH SHAFT	549
MIXED NONWOVEN WHEELS	551
MIXED SCREWDRIVER SET IN FOAM TRAY	432
MIXED SCREWDRIVER SET WITH DIAMOND TIP IN FOAM TRAY	432
MOBILE PARTS WASHER	108
MODULAR DRAWER UNIT WITH PULL-OUT DRAWERS	419
MODULAR DRAWER UNIT WITH PULL-OUT TRAYS	419
MODULAR PLUG CRIMPING TOOL	375
MONOBLOCK STAINLESS STEEL CHROMED VERNIER CALIPER	263
MONOBLOCK STAINLESS STEEL CHROMED VERNIER CALIPER	264
MONOBLOCK STAINLESS STEEL ELECTRONIC DIGITAL CALIPER	262
MORSE TAPER ADAPTER	162
MORSE TAPER ADAPTER	163
MORSE TAPER ADAPTER WITH THREAD	162
MORSE TAPER ADAPTER WITH THREAD	163
MORSE TAPER ADAPTER WITH THREAD	164
MORSE TAPER SHANK TWIST DRILL SET , BLACK FINISHED	218
MORSE TAPER SHANK TWIST DRILL, BLACK FINISHED	217
MORTISING DRILL SET	231
MORTISING MACHINE	081
MOTORCYCLE DOLLY	127
MOTORCYCLE SCISSORS LIFT	127
MOTORCYCLE TYRE LEVER	387
MOTORCYCLE WHEEL BLOCK	127
MOTORIZED 3 ROLL PIPE & PROFILE BENDING MACHINES	073
MOUNTING WITH STUD	157
MPACT ADAPTER SET	356
MPACT XZN BIT SOCKET	350

ART	PAG
MULTI CUTTING POWER TOOLS SET	062
MULTI FUNCTION BRUSH FOR VACUUM CLEANER	111
MULTIFUNCTION CABINET	410
MULTIFUNCTION HAND TRUCK	132
MULTIFUNCTION PLIER	392
MULTI-FUNCTION SPRAY	476
MULTIFUNCTION USB RECHARGEABLE LED LIGHT	490
MULTIFUNCTIONAL ELECTRONIC DIGITAL INDICATOR LARGE DISPLAY	268
MULTILOCK COMBINATION SPANNER SET	320
MULTILOCK SOCKET SET	345
MULTIPURPOSE GREASE	476
MULTIPURPOSE SCISSORS	394
MULTIPURPOSE SHARPENER	068
MULTITOOL BACKPACK	445
NAILS	398
NBR COATED COTTON JERSEY GLOVE	498
NEEDLE FILE SET	385
NIBBLER FOR POWER DRILL	393
NITRILE GLOVE	500
NITRILE GLOVE	501
NITRILE GLOVE CLEAN MONKEY	501
NITRILE GLOVE GREASE MONKEY	501
NON WOVEN ABRASIVE DISCS FOR SURFACE FINISHING	559
NON WOVEN ROLLS	560
NONWOVEN SHEETS	560
NONWOVEN WHEELS	551
NONWOVEN WHEELS WITH BORE	551
NONWOVEN WHEELS WITH SHAFT	550
NOTCHED TROWEL WITH ABS HANDLE	496
NUMBERS HRC 58-60	113
NUT DRIVER SET IN FOAM TRAY	433
NUT DRIVER SET WITH PLASTIC HANDLE	359
NUT DRIVER WITH PLASTIC HANDLE	358
NYLON BRUSHES ON SHAFT	555
NYLON CABLE TIE SET	401
NYLON CLAMP SET	376
O RING HOOK SET	357
OIL DRAIN PAN	474
OIL DRAINER	123
OIL DRAINER WITHOUT TANK	123
OIL FILTER CHAIN WRENCH	329
OIL FILTER STEEL BELT WRENCH	329
OIL FILTER WRENCH SET	329
OPEN END WRENCHES	307
OPEN END WRENCHES SET IN FOAM TRAY	430
O-RING REMOVAL SET	356
O-RING SET	400
OUTSIDE CALIPER	285
OUTSIDE MICROMETER SET	272
PAINT SCRAPER WITH 25 MM CARBIDE BLADE THREE CUTTING EDGES	391
PAINT SCRAPER WITH 50 MM CARBIDE BLADE TWO CUTTING EDGES	391
PAINT SCRAPER WITH 65 MM CARBIDE BLADE TWO CUTTING EDGES	391
PAIR OF FLANGES	550
PAIR OF GLOVES	105
PAIR OF METAL TUBES FOR VACUUM CLEANER	111
PAIR OF PLASTIC TUBES FOR VACUUM CLEANER	111
PANEL SAW	083
PANEL SAW	084
PANEL SAW MOULDER	083
PANELS CONNECTOR	411
PAPER CUTTER BLADE SET	389
PAPER CUTTER BLADE SET	390
PARALLEL KEY SET	400



ART	PAG
PARALLEL VEE BLOCKS	286
PARKING GUIDE MAT	124
PART WASHER WITH HEATING SYSTEM	107
PARTIALLY ASSEMBLED DUST COLLECTOR	094
PARTIALLY ASSEMBLED PANEL SAW	083
PARTS WASHER WITH DUAL PUMP	107
PEN TYPE DIAMOND DRESSER	538
PERCUSSION OPEN WRENCHES	319
PERFORMANCE CUTTING DISC	534
PERFORMANCE CUTTING DISC	535
PERFORMANCE FLAP DISC BIGGER	523
PERFORMANCE FLAP DISC CLASSIC	522
PERFORMANCE FLAP DISC CLASSIC	523
PERFORMANCE FLAP DISC CLASSIC	525
PERFORMANCE FLAP DISC DUAL FLAP	523
PERFORMANCE FLAP DISC DUAL FLAP	525
PERFORMANCE FLAP DISC REAL FLAT	523
PERFORMANCE FLAP DISC TIGER	524
PERFORMANCE GRINDING DISC	535
PERMANENT MAGNETIC CHUCKS	153
PHILLIPS PRECISION SCREWDRIVER	364
PHOTO TYPE DIGITAL TACHOMETER	297
PILOT PIN	220
PILOT TIP	228
PIN FOR CARTRIDGE ROLLS	574
PINK GRINDING WHEEL	069
PIPE CUTTER FOR COPPER AND IRON	395
PIPE CUTTER FOR COPPER AND PLASTIC	395
PIPE FLARING TOOL FOR COPPER AND ALUMINUM	395
PLASTERING TROWEL WITH ABS HANDLE	496
PLASTIC BAG SET	095
PLASTIC CAN WITH SPOUT	474
PLASTIC CREEPER	128
PLASTIC FUEL TANK	479
PLASTIC FUNNEL	475
PLASTIC HOSE FITTING	095
PLASTIC OILER WITH FLEXIBLE SPOUT	474
PLASTIC OILER WITH VERTICAL FLEXIBLE SPOUT	474
PLASTIC PANORAMIC GOGGLES	502
PLASTIC SLEEVE FOR HEX IMPACT SOCKETS	354
PLASTIC SUCTION DISCHARGE GUN	475
PLATFORM STACKER WITH FORKS	139
PLIER SET IN FOAM TRAY	434
PLIER SET IN FOAM TRAY	435
PNEUMATIC AXIAL GRINDING WHEEL	460
PNEUMATIC DOT MARKING MACHINE	112
PNEUMATIC HYDRAULIC SHOP PRESS	116
PNEUMATIC OIL DRAINER	123
PNEUMATIC SERIES FOR AUTOMOTIVE IN FOAM TRAY	435
POCKET DIGITAL MULTIMETER	292
POCKET DIGITAL TEMPERATURE METER	294
POINT COLD CHISEL WITH HAND GUARD	383
POINT DEEP IMPACT SOCKET	349
POINTED PRY BAR	387
POLISHING KIT	562
POLISHING LAMB'S WOOL	566
POLISHING SPONGES	561
POLYCARBONATE EYEGLASS TEMPLE	502
POLYESTER COLORED SLINGS	135
POLYESTER ROUND SLINGS	135
POLYETHYLENE BUCKET	496
POLYETHYLENE PROTECTION COVER SHEET, TWO COLOURS: GREEN - BLUE	497
POLYETHYLENE PROTECTION COVER SHEET, TWO-COLOUR GREEN - BLUE	497
POLYGONAL PERCUSSION WRENCHES	319
POLYPROPYLENE BLISTER SET	441

ART	PAG
POLYPROPYLENE SLIDE	414
POLYPROPYLENE SPRING CLAMPS SET	452
POLYTHENE HELMET	502
POLYURETHANE AND RUBBER HOSE CUTTER	395
POLYURETHANE AND RUBBER HOSE CUTTER	396
POLYURETHANE BACKING PADS	566
POLYURETHANE BACKING PADS	570
POLYURETHANE FOAM GUN	495
POLYURETHANE SPIRAL HOSE WITH SWIVEL MALE FITTING	467
POLYURETHANE WHEEL	132
PORTABLE CHAMFERING MACHINE	070
PORTABLE DIGITAL TEMPERATURE METER	295
PORTABLE DUST COLLECTOR	094
PORTABLE NEON LAMP WITH HOOK	491
PORTABLE PNEUMATIC DOT MARKING MACHINE	112
PORTABLE UNIVERSAL MITRE SAW STAND	085
POSITIONING BELT	502
POWER CHAINSAW SHARPENER	067
PP TWO SHELVES TOOL CART	131
PPL FILM	497
PPL FILM HANDLE DISPENSERS	497
PPL TAPE HAVANA COLOR	497
PRECISION BORING HEAD	169
PRECISION DIVIDER	285
PRECISION DRILL CHUCK SHANK	156
PRECISION LIVE CENTER SET	155
PRECISION MEASURING MILLING VICE	142
PRECISION MITRE SAW	092
PRECISION MORSE TAPER REDUCTION SLEEVE	156
PRECISION SCREWDRIVER AND SPANNER SET	365
PRECISION SCREWDRIVER SERIES	364
PRECISION SCREWDRIVER SET	365
PRECISION SELF CENTERING	158
PRECISION SELF CENTERING CHUCK	159
PRECISION TAPE	287
PRESSURE REGULATOR	467
PRESSURE SANDBLAST CABINET	097
PRESSURE SANDBLAST CABINET	099
PRESSURE SPRAYER WITH BRASS LANCE PIPE	479
PRESSURE SPRAYER WITH BRASS NOZZLE	479
PRESSURE SPRAYER WITH BRASS NOZZLE	480
PRISMATIC ALUMINIUM MAGNETIC JAW PAIR	450
PRISMATIC TYPE TOOL HOLDERS	170
PROFESSIONAL BENCH GRINDER	064
PROFESSIONAL BOOT MADE OF NITRILE RUBBER	508
PROFESSIONAL COMBINED BENCH GRINDER	064
PROFESSIONAL COMBINED BENCH GRINDER WITH LONG ARMS	064
PROFESSIONAL CUTTING DISC	533
PROFESSIONAL CUTTING DISC FOR ALUMINIUM	534
PROFESSIONAL DIAMOND SAW BLADES FOR PORCELAIN GRES, TILES, HARD CERAMICS	539
PROFESSIONAL FLAP DISC BIGGER	527
PROFESSIONAL FLAP DISC CLASSIC	526
PROFESSIONAL FLAP DISC CLASSIC	527
PROFESSIONAL FLAP DISC CLASSIC	529
PROFESSIONAL FLAP DISC DUAL FLAP	527
PROFESSIONAL FLAP DISC DUAL FLAP	529
PROFESSIONAL FLAP DISC REAL FLAT	527
PROFESSIONAL FLAP DISC TIGER	528
PROFESSIONAL GRINDING DISC	533
PROFESSIONAL GRINDING DISC FOR ALUMINIUM	534
PROFESSIONAL SEGMENTED VENTILATED DIAMOND DISCS	539
PROFESSIONAL VENTILATED DIAMOND DISCS	539
PROFESSIONAL ZIRCONIA CUTTING DISC	533

ART	PAG
PROFESSIONAL ZIRCONIA GRINDING DISC	533
PROTECTIVE EARMUFF	505
PROTECTIVE HIGH SHOE	507
PROTECTIVE LOW SHOE	507
PROTECTIVE LOW SHOE	508
PROTRACTOR	290
PRY BAR	386
PRY BAR SET GO THROUGH TYPE	387
PULL BACK RAM2	119
PUNCH PLIER	395
PURE SILICONE OIL	476
PURE ZINC	478
PUTTY KNIFE WITH CLIPPED PLASTIC HANDLE MIRROR POLISH	496
PVC DIESEL GUN	480
PVC PLATFORM TROLLEY	131
PVC SHRINKABLE TUBE ASSORTMENT	402
QUICK ACTING DRILL PRESS VICE	146
QUICK ADJUSTABLE CLAMP	451
QUICK CHANGE 6 POINT BIT HOLDER SET	366
QUICK CHANGE TOOL POST	170
QUICK CHANGE TOOL POST	171
QUICK RELEASE IMPACT EXTENSION BAR	350
RACK WITH 4 PLASTIC TOOL ORGANIZER BOXES	441
RADIAL DRILLING MACHINE	042
RADIAL DRILLING MACHINE	043
RADIAL FLOOR DRILL PRESS WITH DRIVE BELT	051
RATCHET ARBOR PRESS	118
RATCHET BIT HOLDER	366
RATCHET COMBINATION SPANNER SET	314
RATCHET CRIMPING TOOL	375
RATCHET FLEXIBLE HEAD COMBINATION SPANNER	314
RATCHET FLEXIBLE HEAD COMBINATION SPANNER SET	314
RATCHET GEAR WRENCHES	314
RATCHET HAND CABLE CUTTER	396
RATCHET HANDLE	335
RATCHET PLASTIC TUBE CUTTER	395
RATCHET PRUNING SHEARS	397
RATCHET TAP HOLDER	243
RECHARGEABLE ELECTRONIC DIGITAL COUNTER SCALE	302
RECHARGEABLE ELECTRONIC DIGITAL COUNTER SCALES	302
RECHARGEABLE LED LAMP	490
RECHARGEABLE LED LAMP WITH ADJUSTABLE HOOKS AND MAGNETS	491
RECHARGEABLE LED LIGHT WITH MAGNET	489
RECHARGEABLE LED LIGHT WITH MAGNET	490
RED AND WHITE SIGNAL TAPE	497
REDUCER WITH GAUGE AND FILTER	469
REDUCER WITH GAUGE, FILTER AND OILER	469
REDUCTION SLEEVE	170
REFRACTOMETER	298
REFRACTOMETER TO MEASURE FREEZING POINT	298
REINFORCED ABRASIVE SPIRABANDS	573
RESIN CLOTH ROLLS	572
RESINOID BAKELITE POINTS	537
REVERSIBLE AIR DRILL	458
REVERSIBLE AIR DRILL	461
REVERSIBLE TAPPING CHUCK WITH ADJUSTABLE CLUTCH	161
RIBE BIT SOCKET	339
RIBE BIT SOCKET	342
RIBE BITS SET	367
RIGHT HAND AVIATION TIN SNIP	393
RIGHT TOOL BRACKET	184
RING GAUGE FOR ZERO SETTING	275
RING SPANNER SET	319

ART	PAG
RING SPANNER SET IN FOAM TRAY	433
RING SPANNER SET IN FOAM TRAY	434
RING SPANNERS	318
RIVET SET	398
ROCKWELL HARDNESS TESTING MACHINE	299
ROLL FORMING MACHINE	073
ROLL FORMING MACHINE	074
ROLL PIN SET	399
ROLLER STAND	061
ROLLING CABINET	411
ROTARY BURRS FOR ALUMINIUM	541
ROTARY BURRS FOR ALUMINIUM	542
ROTARY BURRS FOR ALUMINIUM	543
ROTARY BURRS FOR ALUMINIUM	544
ROTARY BURRS FOR ALUMINIUM	545
ROTARY LIVE CENTER	155
ROTARY TABLE	104
ROTARY TABLE FOR SANDBLAST CABINET	100
ROUND BRUSH FOR VACUUM CLEANER	111
ROUND DIE-STOCK	243
ROUND HANDLE NEEDLE FILE SET	385
RUBBER GROMMET ASSORTMENT	401
RUBBER HOLDER	548
RUBBER HOLDERS	574
RUBBER MALLET	380
RUBBER PNEUMATIC WHEEL	552
SAFE SPRING HOOK	381
SAFETY BOOT MADE OF NITRILE RUBBER	508
SAFETY BOOT MADE OF PVC	508
SAFETY LANYARD WITH ENERGY ABSORBER	503
SANDBLAST CABINET	102
SANDBLAST CABINET WITH 2 DUST COLLECTORS	099
SANDBLAST CABINET WITH DUST COLLECTOR	100
SANDBLAST CORUNDUM	104
SANDBLAST CYCLON	104
SANDBLAST CYCLON	105
SANDBLAST GUN	105
SANDBLAST MACHINE WITH VACUUM	103
SANDING DISC	567
SANDING DRUM	082
SATIN FINISH COMBINATION SPANNER SET	315
SCALE WITH MULTIFUNCTION DIGITAL READOUT	267
SCORING BLADE WITH CARBIDE TIPPED TEETH	081
SCRAP DUMPING CONTAINER EQUIPPED WITH WHEELS	139
SCRATCH VERNIER CALIPER	264
SCREW AND U TYPE CUSHIONS ASSORTMENT	401
SCREW EXTRACTOR SET	357
SCREWDRIVER BIT AND SOCKET SET	367
SCREWDRIVER SET	362
SCREWDRIVER SET	363
SCREWDRIVER TORX SET	363
SCREWDRIVERS MAGNETIZER/DEMAGNETIZER	365
SCREWS 10PCS	185
SCROLL SAW VARIABLE SPEED	092
SDC WHEEL	069
SEAMLESS COTTON-POLYESTER GLOVE / LATEX	499
SEAMLESS NYLON GLOVE / LATEX	499
SEAMLESS NYLON GLOVE / LATEX	500
SEAMLESS NYLON GLOVE / POLYURETHANE	499
SEAMLESS NYLON GLOVE / POLYURETHANE NINJA LITE	499
SEAMLESS NYLON GLOVE/POLYURETHANE	499
SEAMLESS POLYESTER GLOVE / NITRILE	498
SEAMLESS POLYESTER GLOVE / NITRILE	499
SEAMLESS POLYESTER GLOVE/POLYURETHANE	499
SECURITY SNAP-OFF UTILITY KNIFE, BLADES INCLUDED	389
SEGMENTED VENTILATED DIAMOND DISCS	540



ART	PAG
SELF CENTERING CHUCK	158
SELF-CLOSING CONNECTOR	503
SELF-LOCK STAINLESS STEEL THREAD REPAIR INSERT H=1.5XD	253
SEMI UNIVERSAL DIVIDING HEAD WITH TAILSTOCK AND DIVIDING PLATES	151
SERIES OF ALUMINUM MAGNETIC JAW PAIRS	450
SET 2 PCS OF GERMAN TYPE MALE PLUG	468
SET 2 PCS UNIVERSAL FEMALE QUICK COUPLER	467
SET 2 PCS UNIVERSAL MALE QUICK COUPLER	467
SET 5 BASES 12 MM	184
SET 5 BASES 16 MM	184
SET 5 BASES 16MM	184
SET 5 BASES 9MM	184
SET 5 MOLE	069
SET OF BALL END HEXAGON WRENCHES, LONG TYPE	309
SET OF COMBINATION WRENCHES	307
SET OF HALF MOON RING SPANNERS	321
SET OF HEXAGON WRENCHES	309
SET OF HEXAGONAL HEAD SCREWDRIVERS WITH T-HANDLE	308
SET OF HEXAGONAL HEAD SCREWDRIVERS WITH T-HANDLE IN FOAM TRAY	431
SET OF OPEN END WRENCHES	307
SET OF SCREWDRIVERS	310
SET OF TORX HEAD SCREWDRIVERS WITH T-HANDLE IN FOAM TRAY	431
SET OF TORX SCREWDRIVERS WITH T HANDLE	308
SET STRAIGHT SHANK MULTIFLUTE ROUGHING END MILLS	235
SET TWO AND FOUR FLUTE STRAIGHT SHANK END MILLS	235
SG IRON BENCH VICE	449
SG IRON PARALLEL BENCH VICE	449
SHAFT	565
SHAFT MOUNTED COTTON BUFFINGS	565
SHAFTS SUPPORT FOR DOT MARKING MACHINE	112
SHARPENING STONE (ALUMINUM OXIDE)	538
SHARPENING STONE (SILICON CARBIDE)	538
SHEAR MACHINE BENCH TYPE	072
SHEAR MACHINE WITH STAND	072
SHEAR PRESS BRAKE AND SLIP ROLL	072
SHEEP GRAIN LEATHER-COTTON GLOVE	498
SHOCKPROOF AND SPLASHPROOF DIAL INDICATOR	268
SHOP CRANE LEVELER	122
SHOP PRESS PIN SET	118
SHOP SEAT	128
SHORE "A" DUROMETER TEST BLOCK	299
SHORE "A" DIGITAL DUROMETER	299
SHORE "A" DUROMETER	298
SHORE "D" DIGITAL DUROMETER	299
SHORT TIP FOR VACUUM CLEANER	111
SINGLE CUT LONG ROTARY BURRS	542
SINGLE CUT ROTARY BURRS	541
SINGLE CUT ROTARY BURRS	542
SINGLE CUT ROTARY BURRS	543
SINGLE CUT ROTARY BURRS	544
SINGLE CUT ROTARY BURRS	545
SINGLE CUT ROTARY BURRS	546
SISAL & COTTON DISCS	564
SISAL STITCHED DISCS	564
SISAL/COTTON DISCS	564
SLEDGE HAMMER	379
SLIDE COMPOUND MITRE SAW	084
SLIDING T BAR	338
SLIDING T BAR	340
SLIDING T BAR	343
SLIDING T BAR	344

ART	PAG
SLIM INSPECTION CORDLESS LED LIGHT	490
SLOT PRECISION SCREWDRIVER	364
SLOTTED BITS	370
SLOTTED BITS	371
SLOTTED SCREWDRIVER, HANGING PACKAGE	361
SMALL BRUSH	111
SMARTFLEX FLAP DISC CLASSIC	514
SMARTFLEX FLAP DISC CLASSIC	515
SMARTFLEX FLAP DISC CLASSIC	516
SMARTFLEX FLAP DISC DUAL FLAP	515
SNAP RING SET	400
SNAP-OFF UTILITY KNIFE, BLADES INCLUDED	388
SNAP-OFF KNIFE SET	389
SNAP-OFF UTILITY KNIFE BLADES INCLUDED	388
SNAP-OFF UTILITY KNIFE, BLADES INCLUDED	388
SOCKET LOCKING PIN	356
SOCKET O-RING	356
SOCKET TORX BIT SET	348
SODA BLASTER	103
SODA BLASTING MEDIA	104
SOFT TOP JAW FOR CHUCKS	160
SOLDERING GUN	471
SOLDERING IRON	470
SOLDERING IRON COMBINATION SET	471
SOLDERING IRON SPARE PART TIP	471
SOLDERING IRON TIP SET	470
SOLID BORING BAR	179
SOLID BORING BAR	180
SOLID BORING BAR	181
SOLID BORING BAR SET 90°	178
SOLID BORING BAR SET 90°	179
SOLID BORING BAR SET 95°	178
SOLID BORING BAR SET FOR PRECISION BORING HEADS	169
SOLID CAP SCREW COUNTER BORE BEFORE THREAD GRADE	233
SOLID CAP SCREW COUNTER BORE FINE GRADE	234
SOLID CAP SCREW COUNTER BORE SET BEFORE THREAD	234
SOLID CAP SCREW COUNTER BORE SET FINE GRADE	234
SOLID CAP SCREW COUNTER BORE SET MEDIUM GRADE	234
SOLID THREAD INSERT SPARK PLUG SET	248
SOLVENT AND RELEASING	476
SOUND LEVEL METER	296
SPAR K PLUG WRENCH	328
SPARE BLADE	473
SPARE PART BATTERY	302
SPARE PART BIT SET	114
SPARE PART HEAD	381
SPARE PART INSERT	070
SPARE PART JAWS	142
SPARE PART JAWS	143
SPARE PART POINT	237
SPARE RING	167
SPARK PLUG METRIC THREAD REPAIR F-COIL SET	248
SPARK PLUG SOCKET	340
SPARK PLUG SOCKET	343
SPECIAL VICE FOR 90° WELDING	450
SPECIALTY ALU FLAP DISC CLASSIC	532
SPIRAL BENDER	075
SPIRAL POINT TAP AND DRILL SET	240
SPOT DRILLS	218
SPOUT RUBBER GASKET	479
SPRAY GUN WITH FLUID CUP PROVIDED WITH BAYONET LOCK	466
SPRAY GUN WITH FLUID CUP PROVIDED WITH RAPID LOCK	466
SPRAY GUN WITH GRAVITY FLOW CUP	466

ART	PAG
SPRAY STAINLESS STEEL	477
SPRING	221
SPRING	222
SPRING CLAMP	452
SPRING COLLET	167
SPRING SET	400
SQUARE LEVEL	289
SQUARE TROWELS	496
STAINLESS STEEL 90° KNIFE EDGE SQUARE	282
STAINLESS STEEL DIAL CALIPER	262
STAINLESS STEEL DIAL CALIPER	263
STAINLESS STEEL ELECTRONIC DIGITAL CALIPER	262
STAINLESS STEEL ELECTRONIC DIGITAL DEPTH GAUGE	264
STAINLESS STEEL RULE	265
STAINLESS STEEL RULE	266
STAINLESS STEEL RULE MID	266
STAINLESS STEEL RULE MID	267
STAINLESS STEEL RULE WITH HOOK 90°	267
STAINLESS STEEL SNAP-OFF UTILIY KNIFE	388
STAINLESS STEEL SNAP-OFF UTILIY KNIFE	389
STAINLESS STEEL THREAD REPAIR INSERT	248
STAINLESS STEEL THREAD REPAIR INSERT BSF H=1.5XD	253
STAINLESS STEEL THREAD REPAIR INSERT BSP H=1.5XD	254
STAINLESS STEEL THREAD REPAIR INSERT BSW H=1.5XD	253
STAINLESS STEEL THREAD REPAIR INSERT H=1.5XD	252
STAINLESS STEEL THREAD REPAIR INSERT H=1XD	251
STAINLESS STEEL THREAD REPAIR INSERT H=2.5XD	252
STAINLESS STEEL THREAD REPAIR INSERT H=2XD	252
STAINLESS STEEL THREAD REPAIR INSERT H=3XD	253
STAINLESS STEEL THREAD REPAIR INSERT SET	245
STAINLESS STEEL THREAD REPAIR INSERT SET M5 - M12	245
STAINLESS STEEL THREAD REPAIR INSERT UNC H=1.5XD	254
STAINLESS STEEL THREAD REPAIR INSERT UNF H=1.5XD	254
STANDARD & DEEP IMPACT SOCKET SET	353
STANDARD 12 POINT HAND SOCKET	336
STANDARD 12 POINT HAND SOCKET	338
STANDARD 12 POINT HAND SOCKET	341
STANDARD 12 POINT HAND SOCKET	344
STANDARD 6 POINT HAND SOCKET	336
STANDARD 6 POINT HAND SOCKET	338
STANDARD 6 POINT HAND SOCKET	341
STANDARD 6 POINT HAND SOCKET	344
STANDARD IMPACT SOCKET	349
STANDARD IMPACT SOCKET	351
STANDARD IMPACT SOCKET	352
STANDARD IMPACT SOCKET SET	353
STANDARD IMPACT SOCKET SET	355
STAPLES	398
STEARATE ROLLS	573
STEEL BRUSH	557
STEEL CASE	420
STEEL ENGINEER'S SCRIBER	113
STEEL FILE	386
STEEL PARALLEL COUPLE SET	144
STEEL PARALLEL COUPLE SET	145
STEEL PLUG GAUGE SET	276
STEEL STORAGE CHEST WITH PLASTIC CASES	418
STEEL VICE	448
STEEL VICE WITH PIPE JAW	448
STEEL VICE WITH SWIVEL BASE	449
STEEL WORKBENCH KIT	415
STEPPED CUTTER	237
STEPPED CUTTER SET	237

ART	PAG
STEREO MICROSCOPE	291
STITCHED COTTON DISCS	564
STONING CHISEL SET WITH HAND GUARD	383
STONING HAMMER	379
STRAIGHT AVIATION TIN SNIP	393
STRAIGHT SHANK FACE MILLING CUTTER	186
STRAIGHT SHANK TWIST DRILL	208
STRAIGHT SHANK TWIST DRILL	209
STRAIGHT SHANK TWIST DRILL	212
STRAIGHT SHANK TWIST DRILL SET	210
STRAIGHT SHANK TWIST DRILL SET	211
STRAIGHT SHANK TWIST DRILL SET	214
STRETCH FILM HANDLE DISPENSER	497
STRONG CUT CUTTING DISC	535
STRONG CUT GRINDING DISC	535
STUBBY CROSSTIP (PH) SCREWDRIVER	310
STUBBY DOUBLE-CROSSTIP (PZ) SCREWDRIVER	310
STUBBY FLAT SCREWDRIVERS	309
STUBBY MIRROR POLISH COMBINATION SPANNER SET	320
STUBBY MIRROR POLISH COMBINATION SPANNERS	320
STUBBY RATCHET SCREWDRIVERS	366
SUCTION SPRAY GUN	465
SUPER TURBO DIAMOND BLADE	540
SUPPORT FOR PLATES FOR DOT MARKING MACHINE	112
SURFACE CONDITIONING BELTS	552
SURFACE CONDITIONING DISCS	560
SURFACE CONDITIONING FLAP DISCS	560
T HANDLE MAGNETIC SWIVEL HEX SOCKET	328
T HANDLE MAGNETIC SWIVEL HEX SOCKET SET IN FOAM TRAY	431
TABLE LAMP	486
TABLE TOOL RACK KIT	168
TABLE VICE WITH SWIVEL BASE	448
TALL CABINET	410
TAP AND DIE METRIC SET	240
TAP AND DIE SET	241
TAPE FILM DISPENSER	497
TAPE OIL FILTER WRENCH	329
TAPER DRILL	236
TAPER DRILLS SET	237
TAPER SHANK SHELL END MILL ADAPTER	165
TAPER SHANK SHELL END MILL ADAPTER	165
TAPPING CHUCK	161
TCT HOLE CUTTER	221
TCT HOLE CUTTER SET	221
TEAR-DOWN WORKBENCH WITH FLUID RECOVERY	108
TELESCOPIC RATCHET LOPPING SHEARS TEFLON COATED HARDENED BLADE	397
T-HANDLE DEEP SOCKET WRENCHES	328
T-HANDLE SPARK PLUG SOCKET WRENCH	327
T-HANDLE SWIVEL HEX SOCKET	328
T-HANDLE SWIVEL HEX SOCKETS	328
THERMOCOUPLE "K" TYPE	295
THICKNESS GAUGE FOIL	284
THICKNESSER	080
THREAD PLUG GAUGE "GO" & "NO GO"	276
THREADED BORE FLAP WHEEL	550
THREE SHELVES TROLLEY	131
THREE-DRAWER CAR SEAT	128
TILTING BELT DISC SANDER	091
TILTING BELT SANDER	069
TILTING BELT SANDER	070
TILTING BELT SANDER WITH BENCH	070
TILTING BENCH BELT SANDER	091
TILTING MILLING MACHINE VICE WITH 360° SWIVEL BASE	144
TILTING ROTARY TABLE	147



ART	PAG
TILTING ROTARY TABLE WITH CHUCK	147
TILTING VICE	146
TINMAN'S SNIPS	394
TIP	163
TIP	164
TIP END BRUSHES	557
TITLTABLE MAGNETIC SQUARE	283
TOMMY BAR	322
TOOL BAG	445
TOOL BOX	441
TOOL BOX	442
TOOL BOX WITH ACCESSORIES	438
TOOL BOX WITH ACCESSORIES	440
TOOL BOX WITH TOOLS AND ACCESSORIES	439
TOOL BOX WITH TROLLEY, TOOLS AND ACCESSORIES	437
TOOL BRACKET	184
TOOL BRACKET 16 - 20	184
TOOL BRACKET 25 - 32	184
TOOL CABINET	417
TOOL CABINET WITH 4 DRAWERS	410
TOOL CABINET WITH 5 DRAWERS	410
TOOL CABINET WITH 7 DRAWERS	410
TOOL CABINET WITH 9 DRAWERS	411
TOOL CHEST	423
TOOL CHEST	441
TOOL CUTTING SET	183
TOOL FOR EXTERNAL CUTTING - BLADE	183
TOOL FOR EXTERNAL CUTTING - BLADE TOOL HOLDER	183
TOOL HOLDER SET	168
TOOL HOLDER SHELF	168
TOOL HOLDERS FOR SOCKET	170
TOOL ORGANIZER BOX	441
TOOL ROLLING CABINET	420
TOOL ROLLING CABINET	421
TOOL ROLLING CABINET	424
TOOL ROLLING CABINET KIT	168
TOOL ROLLING CABINET WITH 6 DRAWERS	422
TOOL ROLLING CABINET WITH 6 DRAWERS	423
TOOL ROLLING CABINET WITH 7 DRAWERS	422
TOOL ROLLING CABINET WITH 7 DRAWERS	423
TOOL ROLLING CABINET WITH 8 DRAWERS	422
TOOL ROLLING CABINET WITH 8 DRAWERS	423
TOOL ROLLING CABINET WITH AUTOMOTIVE TOOLS	429
TOOL ROLLING CABINET WITH TOOLS	425
TOOL ROLLING CABINET WITH TOOLS	426
TOOL ROLLING CABINET WITH TOOLS	427
TOOL ROLLING CABINET WITH TOOLS	428
TOOL SCREW	184
TOOL TROLLEY WITH ACCESSORIES	437
TOOL-BOX	442
TORQUE MULTIPLIER	333
TORQUE WRENCH	331
TORQUE WRENCH	332
TORQUE WRENCH SET	332
TORQUE WRENCH SET	333
TORQUE WRENCHES	332
TORX BIT SOCKET	337
TORX BIT SOCKET	339
TORX BIT SOCKET	342
TORX BITS	370
TORX BITS	371
TORX KEY SET	326
TORX KEY SET LONG TYPE	325
TORX KEY SET WITH DIAMOND TIP	326
TORX PRECISION SCREWDRIVER	364
TORX PRECISION SCREWDRIVER SERIES	364

ART	PAG
TORX SCREWDRIVER SET	365
TORX SCREWDRIVERS WITH T-HANDLE	308
TOWER PINNERS	377
TRANSMISSION JACK	122
TRANSPORT TROLLEY	137
TRIPOD ELECTRIC RADIANT INFRARED HEATER	482
TRIZACT BELTS	552
TROLLEY	411
TROLLEY ABS TOOL CASE	443
TROLLEY PRESSURE SPRAYER WITH BRASS LANCE PIPE	479
TRUCK PALLET WITH SCALE	137
TRUCK PALLET WITH SCALE AND PRINTER	137
TUBE ROTARY LIVE CENTER	155
TUBE SUPPORT FOR DOT MARKING MACHINE	112
TUNGSTEN CARBIDE TIPPED HOLE CUTTER	221
TUNGSTEN STEEL TAP AND DIE METRIC SET	240
TURBO POLISHING DIAMOND CUP WHEEL FOR GRANITE AND STONE	538
TURNING INSERTS	195
TURNING INSERTS	196
TURNING INSERTS	197
TURNING INSERTS	198
TURNING INSERTS	199
TURNING INSERTS	200
TWIST DRILL AND COUNTERSINK SET WITH 1/4" HEX SHANK	232
TWIST DRILL GRINDING MACHINE	067
TWIST DRILL GRINDING MACHINE	068
TWIST DRILL SET	209
TWIST DRILL SET	211
TWIST DRILL SET WITH COUNTERSINK FOR WOOD	231
TWIST DRILLS GRINDING MACHINE	067
TWIST DRILLS WELDON SHANK	218
TWIST DRILLS WELDON SHANK	219
TWISTED KNOTS BEVEL BRUSHES	555
TWISTED KNOTS BRUSH WITH SHAFT	556
TWISTED KNOTS CIRCULAR BRUSHES	554
TWISTED KNOTS CUP BRUSHES	555
TWISTED KNOTS END BRUSHES	557
TWISTED LAMBS WOOL DISC	565
TWO WAY HEX KEY WITH ANATOMIC PLASTIC HANDLE	324
TWO WAY HEX KEY WITH ANATOMIC PLASTIC HANDLE SET IN FOAM TRAY	431
TWO WAY HEX KEY WITH PLASTIC HANDLE	324
TWO WAY MALLETT	380
TWO WAY RUBBER MALLETT	380
TWO WAY TORX AND TAMPERED KEY WITH ANATOMIC PLASTIC HANDLE	326
TWO WAY TORX KEY WITH ANATOMIC PLASTIC HANDLE SET IN FOAM TRAY	431
TWO WAY TORX KEY WITH PLASTIC HANDLE	327
TYRE INFLATING GUN	463
TYRE INFLATING GUN	464
TYRE LEVER	387
ULTRASONIC THICKNESS GAUGE	298
UNC F-COIL STI TAP	256
UNC THREAD REPAIR F-COIL SET	250
UNF F-COIL STI TAP	257
UNF THREAD REPAIR F-COIL SET	251
UNITIZED DISCS	559
UNITIZED FLAT DISCS	559
UNIVERSAL BENCH FOR DRILLING MILLING MACHINES	036
UNIVERSAL BENDER	074
UNIVERSAL BEVEL PROTRACTOR	290
UNIVERSAL CRIMPING PLIER SET	376
UNIVERSAL CYLINDER CARBIDE TIPPED BORING BIT	231
UNIVERSAL DIVIDING HEAD WITH TAILSTOCK, CHUCK AND DIVIDING PLATES	150

ART	PAG
UNIVERSAL GRAFTING MACHINE	397
UNIVERSAL HOLE CUTTER WITH WELDON SHANK	220
UNIVERSAL HOLE CUTTERS WITH WELDON SHANK	219
UNIVERSAL JOINT	337
UNIVERSAL JOINT	340
UNIVERSAL JOINT	343
UNIVERSAL JOINT	344
UNIVERSAL MECHANICAL ARM STAND	279
UNIVERSAL MILLING MACHINE	031
UNIVERSAL STORAGE BIN	420
UNIVERSAL SUPPORT UNIT FOR LATHE WITH CHUCK SAFETY GUARD WITH MICROSWITCH	173
UNIVERSAL TELESCOPIC CART	128
VACUUM SANDBLAST CABINET	098
VASELINE OIL	478
VEHICLE POSITIONING JACK	127
VELCRO DISCS	568
VELCRO DISCS	569
VELCRO DISCS "GOLD"	568
VELCRO FELT DISCS	563
VELCRO PAPER ROLLS	571
VELCRO SANDING SCREEN	569
VELCRO TRIZACT™ DISCS	569
VENTILATED COTTON DISCS	563
VENTILATED DIAMOND SAW BLADES	539
VENTILATED DISCS	564
VENTILATED FELT WHEEL	563
VERNIER HEIGHTGAUGE CHROME PLATED	265
VERTICAL HEAVY DUTY LOG SPLITTER	093
VERTICAL MILLING MACHINE	029
VERTICAL MILLING MACHINE	030
VERTICAL SANDBLAST CABINET	102
VERTICAL SANDBLAST CABINET WITH VACUUM	101
VIBRATION TESTER	297
VINYL GLOVE	501
VIPER SEMI FLEXIBLE FIBER DISC	534
VITRIFIED MOUNTED POINTS	537
VULCANISED FIBRE DISCS	567
WALL CABINET	411
WALLCABINET KIT	416
WASHER SET	399
WASHING GUN	463
WASHING GUN	464
WATER PROOF TOOL CASE	442
WATER PUMP PLIERS	377
WATERPROOF LED TORCH	486
WATERPROOF PORTABLE BATTERY LAMP	486
WATERPROOF TOOL CASE	442
WATERPROOF TOOL CASE	443
WATERPROOF TOOL CASE WITH TROLLEY	443
WELDING ANTIADHESIVE	477
WELDING HOLDER	283
WELDON SHANK CORE DRILL SET	219
WELDON SHANK TOOL HOLDER	162
WELDON SHANK TOOL HOLDER	163
WELDON SHANK TOOL HOLDER	165
WESTCOTT CHUCK	081
"WESTCOTT" CHUCK	081
WET AND DRY VACUUM CLEANER	109
WET BRUSH FOR VACUUM CLEANER	111
WET DRY BENCH GRINDER	065
WET DRY BENCH GRINDER	066
WHITE GRINDING WHEEL	069
WHITE NON WOVEN POLISHING DISCS	565
WINDOW PROTECTION SET	105
WINTER BOOT	509
WIRE BRUSH SET FOR AUTOMOTIVE AND WORKSHOP	557

ART	PAG
WIRE CONTROL FOR DOT MARKING MACHINE	112
WIRE ROPE PULLING HOIST	136
WOBBLE EXTENSION BAR	337
WOBBLE EXTENSION BAR	340
WOBBLE EXTENSION BAR	343
WOOD BAND SAW	087
WOOD BAND SAW	088
WOOD BAND SAW	089
WOOD BAND SAW	090
WOOD CARBIDE TIPPED SAW BLADES	258
WOOD CHISEL	384
WOOD CHISEL SET	384
WOOD CHISEL SET FOR LATHE	384
WOOD HANDLE CLAMP	451
WOOD LATHE	076
WOOD LATHE	077
WOOD LATHE WITH COPY DEVICE	076
WOOD RASP SET WITH PLASTIC HANDLE	385
WOOD-BURNING PEN SET WITH 6 PINS OF DIFFERENT SHAPE	470
WOODRUFF METRIC KEY SET	400
WORK PLATES	412
WORKBENCH KIT	415
WORKBENCH KIT	416
WORKING BOOT MADE OF PVC	509
WORKING LAMP HOLDER WITH 5 M POWER CORD	491
WORKSHOP MODULAR FURNITURES	405
WORKSHOP MODULAR FURNITURES	406
WORKSHOP MODULAR FURNITURES	407
WORKSHOP MODULAR FURNITURES	408
WORKSHOP MODULAR FURNITURES	409
WRECKING BAR	387
XZN BIT SOCKET	337
XZN BIT SOCKET	340
XZN BIT SOCKET	343
Y FITTING	095
YELLOW PAINTED JOINER SQUARE	282
ZERO SETTING WITH DIAL INDICATOR WITH MAGNETIC BASE	271
ZINC ADHESIVE LUBRICANT FOR CHAINS	478
ZIRCOCER FLAP DISC CLASSIC	530
ZIRCOCER FLAP DISC CLASSIC	531
ZIRCOCER FLAP DISC RAPTOR	531
ZIRCONIA CLOTH BELTS	552



ART	PAG	ART	PAG	ART	PAG	ART	PAG
0010	130	0083	364	0144	092	0214	385
0011	055	0085	495	0147	122	0217	127
0012	054	0086	367	0149	453	0219	385
0020	374	0087	231	0150	398	0220	325
0022	070	0088	356	0151	398	0221	317
0023	065	0089	366	0152	383	0222	317
0024	471	0090	325	0159	393	0223	318
0026	471	0091	495	0160	385	0226	392
0028	138	0092	395	0161	392	0228	335
0029	293	0094	122	0162	384	0229	399
0031	470	0095	389	0163	538	0231	399
0034	473	0096	388	0165	440	0232	108
0035	389	0102	074	0166	384	0233	108
0037	471	0103	497	0168	384	0234	495
0038	107	0104	368	0173	335	0235	071
0043	497	0105	438	0176	402	0236	133
0044	457	0106	066	0177	400	0238	231
0045	457	0107	489	0178	399	0241	127
0046	458	0109	288	0179	400	0242	053
0047	458	0110	438	0180	400	0244	365
0048	466	0112	288	0181	348	0245	365
0049	462	0113	075	0186	051	0250	450
0050	459	0115	459	0187	320	0251	557
0051	459	0116	400	0190	325	0253	396
0052	457	0117	134	0192	387	0254	445
0058	372	0118	377	0195	345	0255	060
0059	460	0119	377	0196	320	0257	400
0060	121	0120	377	0197	074	0258	383
0063	122	0121	377	0198	387	0259	383
0064	138	0122	376	0200	315	0260	054
0065	120	0123	490	0201	315	0261	401
0066	136	0124	372	0202	387	0263	400
0067	121	0125	463	0203	107	0264	445
0070	136	0126	382	0204	316	0266	322
0071	473	0127	383	0205	450	0267	387
0073	318	0128	488	0206	377	0268	331
0075	130	0132	060	0207	365	0269	325
0076	329	0133	061	0208	316	0270	330
0077	329	0136	376	0209	488	0271	119
0080	330	0137	331	0210	326	0272	481
0081	395	0138	092	0211	108	0273	059
0082	365	0141	394	0212	283	0274	479

ART	PAG	ART	PAG	ART	PAG	ART	PAG
0277	369	0356	479	0416	460	0472	395
0280	084	0358	367	0417	461	0476	319
0289	480	0360	333	0418	461	0477	319
0290	105	0362	060	0419	461	0478	125
0291	489	0365	085	0420	390	0479	125
0293	402	0366	485	0421	461	0480	487
0294	399	0367	392	0424	395	0483	071
0295	398	0369	120	0428	492	0484	367
0296	399	0371	174	0429	491	0485	118
0297	395	0372	174	0430	127	0486	107
0298	399	0377	064	0431	473	0487	102
0300	384	0379	377	0432	125	0490	103
0303	479	0380	402	0433	298	0491	487
0304	366	0381	383	0434	439	0492	489
0305	107	0384	391	0436	486	0495	094
0306	384	0385	480	0437	487	0496	094
0308	335	0386	480	0441	472	0498	079
0310	103	0387	297	0442	321	0499	080
0311	489	0390	445	0443	471	0500	060
0312	298	0391	383	0444	472	0502	067
0313	459	0392	108	0446	293	0503	066
0315	440	0393	345	0447	125	0504	083
0316	067	0395	445	0449	288	0505	091
0317	402	0396	383	0451	330	0506	024
0318	402	0397	488	0452	127	0507	094
0320	387	0398	401	0453	372	0508	473
0321	473	0399	439	0454	372	0510	065
0322	397	0400	324	0455	371	0511	379
0325	394	0401	490	0456	357	0512	049
0327	393	0402	368	0457	120	0513	397
0329	333	0403	368	0458	461	0515	397
0331	557	0404	368	0459	462	0516	485
0332	227	0405	327	0460	461	0519	385
0333	473	0406	366	0461	132	0521	495
0338	489	0407	366	0462	103	0522	061
0339	458	0408	445	0463	231	0523	091
0341	353	0409	445	0465	401	0524	232
0342	491	0411	390	0467	130	0526	232
0343	485	0412	464	0468	401	0529	230
0344	485	0413	460	0469	371	0530	485
0350	540	0414	460	0470	372	0536	174
0355	364	0415	390	0471	356	0543	462



ART	PAG	ART	PAG	ART	PAG	ART	PAG
0544	315	0603	376	0670	393	0784	460
0546	315	0604	495	0672	394	0786	457
0547	366	0605	099	0673	394	0787	488
0548	366	0606	496	0677	475	0789	372
0549	366	0607	463	0678	495	0792	389
0551	064	0608	463	0679	347	0793	470
0552	064	0609	464	0682	443	0796	076
0553	064	0610	464	0683	443	0801	396
0554	064	0611	389	0684	081	0804	068
0555	066	0612	388	0687	101	0813	375
0556	064	0613	388	0688	170	0814	375
0557	445	0614	321	0693	490	0816	538
0559	082	0615	099	0694	472	0817	538
0560	070	0617	388	0696	389	0822	496
0565	062	0618	348	0697	081	0823	496
0567	120	0620	347	0706	473	0826	376
0568	062	0622	348	0708	023	0828	401
0570	459	0623	388	0709	540	0829	365
0571	457	0624	346	0710	023	0830	239
0573	456	0625	486	0716	024	0833	538
0574	458	0626	367	0718	239	0834	377
0575	102	0627	388	0720	092	0836	462
0576	457	0628	375	0725	464	0840	491
0580	103	0629	392	0747	497	0841	375
0581	104	0632	108	0748	497	0842	397
0583	298	0633	362	0749	080	0843	375
0585	453	0634	363	0750	053	0844	395
0586	454	0640	369	0751	076	0847	375
0587	453	0641	459	0752	050	0849	420
0589	346	0642	062	0755	481	0853	356
0590	136	0644	460	0756	094	0855	089
0592	124	0648	077	0757	055	0857	051
0593	346	0657	023	0758	076	0861	496
0594	123	0658	121	0759	094	0862	396
0595	123	0659	486	0760	497	0863	397
0596	123	0661	486	0764	087	0864	471
0597	489	0662	070	0765	092	0865	472
0598	124	0663	119	0775	073	0869	392
0599	036	0664	119	0776	074	0871	084
0600	133	0665	083	0780	379	0876	401
0601	100	0666	288	0781	379	0877	402
0602	133	0668	074	0782	139	0878	101

ART	PAG	ART	PAG	ART	PAG	ART	PAG
0887	362	0096/L	390	0199x	316	0323/55	441
0888	365	0101/500	397	0201-	315	0333/150	473
0889	490	0105T	437	0205/120	450	0334/0750	072
0890	243	0110T	437	0208-	316	0334/1000	072
0891	485	0116P	400	0215x	323	033x	380
0892	071	0129-	282	0216/400	380	0340S	321
0893	075	0130-	378	0218-	483	0341-	353
0013/142	293	0132-	282	0218/50T	484	0341/3LS	354
0013/185	293	0134-	320	0218-xB	483	0341/5S	354
0018/15	329	0134S	320	0218-xS	484	0341-5x	354
0018/30	329	0135-	448	0222-	317	0341-xL	354
0019-	335	0139-	282	0224-	318	0352-	329
0020/1	374	0140-	448	0225-	378	0353/085	452
0020/2	374	0142-	145	0227-	378	0353/110	452
0020/3	374	0143/25	139	0237-	133	0357-	329
0020/4	374	0143A	139	0239/400	380	0359-	327
0020/5	374	0145-	448	0240/15	469	035x	452
0020/6	374	0146/60	449	0243-	380	0363-	420
0027/30W	470	0148/500	380	024x	376	0368-	378
0027/40W	470	0148/64	504	0252/230V	049	0370-	378
0027/40W/TIP	470	0148/72	504	0252/400V	049	0373-	378
0028R	138	0148/73	504	0256-	129	0375A	120
0033A	470	0153-	379	0265/05	452	0376/AC	398
0033A/TIP	470	0154-	379	0278-	223	0376/AI	399
0036-	448	0156-	474	0278/002S	223	0376/AL	399
0036-xG	448	0157-	452	0278/005S	223	0378/1510	468
0037/TIP	471	0158/500	474	0278/008S	223	0382-	420
0042-	449	0164/250	474	0278/009S	223	0389-	392
0054-	119	0167-	451	0285/75	071	0394-	451
0056-	132	0169-	380	0286-	282	0400-	324
0062-	129	0171-	474	0287-	396	0405-	327
0068/S	137	0172/150	475	028x	497	0422-	441
0068L	137	0174-	449	0292-	075	0423/1	441
0069-	121	0183/750	474	0299-	400	0423/2	441
0070/C	136	0184-	496	0301-	384	0425-	078
0072A	122	0188-	146	0302/200	090	0426-	330
007x	328	0188-xG	146	0302/245	090	0427-	449
0084-	321	0189-	479	0302/305	090	0439-	334
0087/35	231	0192-	387	0307/1	401	0440-	335
0090-	325	0194x	479	0307/2	401	0442-	322
0093/22	395	0196-	320	0310B	104	0445/20	491
0093/42	395	0199P-	317	0323/45	441	0442/55	106



ART	PAG	ART	PAG	ART	PAG	ART	PAG
0466/4V	436	0520-xP	450	0630/2200	123	0677/SO	475
0466/C	436	0520-xS	450	0630/2720	123	0686/200	081
0466/CV	436	0531A	174	0632-	108	0686/200C	082
0466/DM	365	0532A	174	0635/25	134	0687/005	105
0466/PB	436	0532A/230V	174	063x	376	0687/029	105
0466/SA	436	0537A	174	0643-	486	0687/041	105
0466/SC	436	0538A	174	0645/C	128	0687/102	106
0473-	474	0540-	322	0645/CC	128	068x	443
0474/PA	481	0540/3	322	0645/CP	128	0690-	314
0474/PE	481	0540S	322	0645/CS	128	0690/07P	314
0474/PP	480	0541S	321	0645/S	128	0690/12P	314
0476-	318	0545/EF	323	0645/SS	128	0691/400V	069
0481/15	468	0545/TF	326	0646/A	287	0692/230V	059
0482/3	487	0552/400V	064	0647/25	391	0692/400V	059
0490/03	105	0554/400V	064	0647/25L	391	0696/L	389
0490/11	105	0558/EM	323	0647/50	391	0698/100	146
0490/20	106	0558/EP	323	0647/50L	391	0699/240	394
0493/1	487	0558/GE	323	0647/65	391	06x	134
0493/2	487	0558/TX	326	0647/65L	391	0700-	314
0494-	334	0559/T	082	0649-	124	0700/07P	314
0495/24	095	0561/B	302	0651/5	493	0700/12P	314
0497-	077	0575/04	105	0651/6	493	0712-	224
0499/C	081	0575/0580/12	106	0651/6S	493	0712/002	224
0507/07	095	0575S	102	0654-xF	137	0712/005	224
0507/14	095	0577/17	106	0654-xL	137	0712/008	224
0507/15	095	0580/01-6	105	0655/L	393	0712/009	224
0507/4R	095	0580S	102	0655/R	393	0712/010	225
0509/245	088	0582-	104	0655/S	393	0712/900	225
0509/305	088	0584-	398	0656/254	083	0712-x0	225
0509/340	088	0585-	398	0656/310	084	0712-x00	225
0514-	379	0587-	398	0657/B	023	0713/15	484
0517/59	082	0588-	398	0659-	486	0713/18	484
0517A	080	0588/6	454	0660-	479	0713/27	484
0518/20	056	0591-	448	0667/100	069	0716/B	025
0518/30	056	05x	105	0667/150	070	0716S	024
0518/38M	057	0601/24	105	0670/U	393	0717A	090
0518/50	056	0601/30	105	0671/1P	488	0720/L	092
0518/55H	057	0614-	321	0671/8	488	0724/B	393
0518/80	057	0621/A3	492	0672/B	394	0725L	464
0520-xA	449	0626L	367	0677/500	475	072x	381
0520-xF	450	0627/L	389	0677/CG	475	073x	381
0520-xG	449	0630/0900	124	0677/IA	475	0742-	386

ART	PAG	ART	PAG	ART	PAG	ART	PAG
0749/C	081	0806/020	331	1-xA	162	A007C	405
0749/M	081	0806/200	330	1-xD	163	A007D	405
0749/MC	081	0807/150	288	2622x	160	A007E	406
074x	386	0808-	380	2-xA	162	A007F	406
0750CM3	053	0809-	331	2-xB	164	A007G	406
0751/A4	078	0815-	332	2-xD	163	A007H	406
0751/P	078	0818/250	394	3/B/40	166	A007I	407
0752CM3	050	0819-	496	3A40-	166	A007L	407
0753/A	092	0820-	496	3-CM	166	A007M	407
0753/L	092	0821/14	496	3D40-	166	A007N	407
0754/230V	050	0824-	289	4-	162	A007P	408
0754/400V	050	0831-	377	4-xB	165	A007Q	408
0756/F	095	0835/15	239	4-xD	163	A007R	408
0756/S	095	0839-	381	A001-	156	A007S	408
0756/T	095	0839-xT	381	A003/13A	068	A007T	409
0756/Y	095	0846/150	396	A003/13ACBN	069	A007U	409
0758/C	077	0855-	326	A003/13ASDC	069	A007UF	409
0759/F	095	0856-	324	A003/32	067	A007V	409
0759/S	095	0870/250	085	A003/32CBN	069	A007xP	412
0762-	258	0872/OPD	373	A003/32SDC	069	A008A	405
0764/455	087	0872/P	373	A005	296	A008B	405
0773-	074	0872/PCD	373	A007/01	411	A008C	405
0773/05L	074	0872/PDD	373	A007/02	410	A008D	405
0773/10L	074	0873/TF	374	A007/03	410	A008E	406
0777/2	469	0873/TL	373	A007/04	410	A008F	406
0777/3	469	0873-BC	373	A007/05	410	A008G	406
0783-xF	468	0873-BD	373	A007/06	410	A008H	406
0783-xM	468	0873-U	373	A007/07	411	A008I	407
0785-xF	467	0880/307	363	A007/10	411	A008L	407
0785-xM	467	0881/008	363	A007/11	412	A008M	407
0791-	136	0890-	243	A007/16	411	A008N	407
0792/L	390	0895-	319	A007/17	410	A008P	408
0794-	380	0896-	319	A007/18	410	A008Q	408
0795/1	345	08x	375	A007/20	411	A008R	408
0795/2	345	08xx	375	A007/21	411	A008S	408
0799-	231	165x	204	A007/21I	411	A008T	409
07x	258	16Ax	162	A007/22	411	A008U	409
0803-	332	16-B	164	A007/23	410	A008UF	409
0803/S080	333	16-CM	165	A007/LED	412	A008V	409
0803/S210	332	16-D	164	A007/LED/C	412	A009	281
0804/MD	069	16ERx	204	A007A	405	A010-	492
0805/400	289	16IRx	204	A007B	405	A010/20G	493



ART	PAG	ART	PAG	ART	PAG	ART	PAG
A010/30	493	A601DS	465	B004/150	302	BE20/10S	308
A010/30T	493	A602A	465	B005-	205	BE21-	308
A010-x	492	A901A	466	B006-	382	BE21/10S	308
A013/26	067	A902A	466	B007-	175	BE22/S9	309
A013/26M	069	ACAS/001	111	B009/A1	416	BE23/S9	309
A0132A	068	ACAS/002	111	B009/A2	416	BE30-	311
A0132A/MB	069	ACAS/003	111	B009/B1	416	BE31-	311
A0132A/MR	069	ACAS/004	111	B009/B2	416	BE32-	311
A014-	236	ACAS/005	111	B010	280	BE33-	311
A014/03-30S	237	ACAS/006	111	B012-	206	BE34-	312
A014/06-20E	236	ACAS/007	111	B013-	206	BE35-	312
A015-	275	ACAS/008	111	B014-	206	BE36-	312
A016-	270	ACAS/009	111	B015	415	BE37-	312
A017x	276	ACAS/010	111	B015/10	415	BE38-	313
A018x	276	ACAS/011	111	B017	415	BE39-	313
A019-	280	ACAS/012	111	B017/C	415	BE40-	313
A020	271	ACAS/013	111	B018	301	BE50-	309
A024/10	109	ACAS/014	111	B019	414	BE50-2	309
A024/602	110	ACAS/015	111	B019/G030	414	BE51-	309
A025/30	109	ACAS/016	111	B021	301	BE51/2025	310
A040/30A	109	ACAS/017	111	B022/10	415	BE52-	310
A040/60A	109	ADF-	558	B022/15	415	BE52/2025	310
A040/802	110	ADLTx	201	B025	280	BE53/07S	310
A040/8029	111	ADLTxA	201	B031	301	BGAx	561
A040/803	110	ADLTxA1	201	B040-	281	BI413L0x	350
A040/8037	111	ADR3/6	549	B0x	274	BI423Lx	350
A040/8040	111	AI401NAx	356	B100	277	BI433Mx	350
A040/8046	111	AI401NSx	356	B201/1	277	BI443Mx	350
A040/8047S	111	AN2G/12/1	134	B201/2	277	BI4E1Lx	352
A040/8047U	111	AP01	455	B201/3	277	BI4E1Nx	352
A040/8048	111	AP02	455	B201/4	277	BI4E2Lx	351
A059	068	AP03	455	B609	483	BI4E2Nx	351
A059/M	069	AP04	455	B610	483	BI4E3Lx	349
A100	417	AP05	456	BASECKJNL	184	BI4E3Nx	349
A12AL6	541	AP05/150	456	BASECKJNR	184	BN413Lx	342
A162A	466	AP06	456	BE10-	307	BN413Nx	342
A162C	466	APKTx	201	BE10/08S	307	BN414Lx	339
A162DS	466	AxDC	541	BE10/12S	307	BN414Nx	339
A208B-	233	AxSC	541	BE11-	307	BN415Nx	336
A212-	233	B001-	169	BE11/17S	307	BN423Lx	342
A300	417	B003/5/1	301	BE11/26S	307	BN423Nx	342
A601A	465	B004-	302	BE20-	308	BN424Lx	339

ART	PAG	ART	PAG	ART	PAG	ART	PAG
BN424Nx	339	BU4050	184	C039/15	121	C1102	132
BN425Nx	337	BU4560	184	C039/25	121	C163	442
BN433Lx	342	BxAL	542	C041/150	262	C165	442
BN433Nx	342	BxDC	542	C043-	262	C182	132
BN434Lx	339	BxDCxL	542	C044-	264	C189	132
BN434Nx	339	BxSC	541	C046-	155	C190	422
BN443Lx	343	BxSCxL	542	C047/500	262	C190C	425
BN443Nx	343	C001-	235	C048	269	C245-	328
BN444Lx	340	C002	268	C049/300	264	C312	441
BN444Nx	340	C002/42	269	C050-	155	C313	441
BN445Nx	337	C003-	235	C051	149	C315	441
BN4C3Lx	343	C004	268	C052	149	C360	442
BN4C4Lx	340	C005/150	262	C053-	155	C371	442
BN4E2Nx	344	C006-	263	C054	149	C391-	328
BN4E3Lx	341	C007-	264	C055-	155	C395-	328
BN4E3Nx	341	C009	131	C056/200	263	C586	453
BN4E4Lx	338	C010/200	264	C057/150	263	C589	454
BN4E4Nx	338	C010/200P	070	C058	285	C600	417
BN4E5Lx	336	C011-	263	C060	268	C600-	417
BN4E5Nx	336	C012-	382	C061	271	C603	417
BN4P2Nx	344	C013/10/30	270	C062	271	C603-	418
BN4P3Lx	341	C014-	271	C063	271	C648	442
BN4P3Nx	341	C015	382	C063/L	271	C650	131
BN4P4Nx	338	c015-	382	C064	268	C655	424
BN4P5Nx	336	C016	271	C065/2	131	C660	421
BRAS4103x	206	C017	268	C067	297	C670	421
BRAS4104x	205	C018-	263	C069	297	C700	418
BRAS4109x	206	C019/150	263	C070	297	C750	131
BRAS4111x	205	C020-	264	C075/2	131	C800	417
BRCIx	205	C021-	264	C076/30	073	C800-	417
BRFEx	205	C022/100	073	C080-	418	C855-	327
BRFlix	205	C023-	268	C081	420	C856-	324
BSAx	561	c025-	275	C085-	418	C880/006	362
BSCL09	184	C025-3x	275	C086/01C	419	C882-	361
BSCL12	184	C026-	285	C086/01T	419	C882/2038	362
BSDJ11	184	C027-	285	C086/02C	419	C883-	361
BSER16	185	C028-	285	C086/02T	419	C884-	361
BSNR16	185	C029-	285	C086/04C	419	C884/6038	361
BSSS12	184	C030-	139	C086/04T	419	C885-	362
BSTG16	184	C031/150	262	C086/12C	419	C885/2038	362
BSVJ16	184	C033-	262	C087	420	C900/A	423
BU3550	184	C038/30	120	C090-	420	C900/B	424



ART	PAG	ART	PAG	ART	PAG	ART	PAG
C900/BE01	426	CNMGxF25	195	D17x	567	DFC115/M14	563
C900/BE02	427	CNMGxM25	195	D880/006	361	DFFx	562
C900/CC01	428	CNMGxM35	196	D882-	360	DFVx-xA	567
C902/B	424	CR20x	402	D882/2038	360	DFVx-xZ	567
C960/AM01	429	CRDxC	574	D883-	360	DLFx	562
C960/B6	423	CRDxT	574	D884-	360	DMV150	564
C960/B7	423	CSCD-	558	D884/6038	360	DN2100-A	516
C960/B8	423	CSDS-	558	D885-	360	DN2100-Z	515
C960/BE01	426	CSF-	558	D885/2038	361	DN2300-Z	515
C960/CC01	428	CTFP10/12	184	DC200	565	DN4100-A	520
C960/F6	422	CTFPBASE25/32	185	DCGx	565	DN4100-Z	519
C960/F7	422	CTFPx	181	DCK100	563	DN4300-A	520
C960/F8	422	CTMTMC16/20	184	DCMTx	196	DN4300-Z	519
C960C	425	CTMTMC25/32	184	DCMTxA	196	DN4550-Z	519
C980	421	Cx	131	DCTx	564	DN6100-A	525
C980/CC01	427	CxAL	542	DCVx	564	DN6100-Z	523
C980/G1	421	CxDC	542	DF2100-A	516	DN6300-A	525
C980/G2	421	CxSC	542	DF2100-Z	514	DN6300-Z	523
C980/G3	421	D001	299	DF2150-A	516	DN6550-Z	523
CB01-	358	D003	147	DF2150-Z	514	DN8100-A	529
CB01/04P	359	D004-	150	DF4100-A	520	DN8100-Z	527
CB01/07P	359	D005-	148	DF4100-Z	518	DN8300-A	529
CB01/11P	359	D006-	151	DF4150-A	520	DN8300-Z	527
CB02-	358	D007/A	298	DF4150-Z	518	DN8550-Z	527
CB02/04P	359	D009/5-12	230	DF4600-Z	519	DN9100-ZC	531
CB02/07P	359	D009/5-85	230	DF6100-A	525	DNMGx	196
CB02/11P	359	D011/A	299	DF6100-Z	522	DNMGxM25	196
CBF1-	358	D011/D	299	DF6150-A	525	DNMGxM35	196
CBF1/10P	359	D012-	302	DF6150-Z	522	DNW100	565
CCGx	565	D018	300	DF6600-Z	523	DSCx	564
CCMTx	195	D020	238	DF6700-Z	524	DSK100	564
CCMTxA	195	D023	147	DF8100-A	529	DSTx	564
CHERx	167	D040-	539	DF8100-Z	526	DxAL	543
CI80/006	363	D045-	539	DF8150-A	529	DxDC	543
CI82-	363	D050	238	DF8150-Z	526	DxSC	542
CI83-	363	D054-	540	DF8600-Z	527	E001	357
CKJNx	177	D055-	539	DF8700-Z	528	E002-	156
CKUNR	181	D059-	539	DF9100-ZC	530	E003	357
CN450N0/0	334	D060-	539	DF9103-M	532	E005	357
CN450Nx	334	D070-	539	DF9150-ZC	530	E010	245
CNMGx	195	D100	538	DF9153-M	532	E010-	245
CNMGxF15	195	D100/S	538	DF9800-ZC	531	E010B	245

ART	PAG	ART	PAG	ART	PAG	ART	PAG
E010-BSFxEEx	253	E011-UNFxE	251	F015/005	222	F407-	188
E010-BSPxEEx	254	E011-UNFxE M	257	F015/006S	222	F430	237
E010-BSWxEEx	253	E011-UxE	257	F015/007	222	F585	453
E010E	245	E022/12	291	F015/008S	222	F588/6	453
E010-MxE1	251	E022/5	291	F015-A	222	F639	237
E010-MxE15	252	E022/P	291	F018	394	F68x	287
E010-MxE2	252	E023/5	291	F019-	221	F80x	287
E010-MxE25	252	E190-	357	F019/005	221	FC94/245	089
E010-MxE3	253	E190-BxE	357	F019/006	221	FC94/350	089
E010-MxExA	253	E191-	357	F019/007	221	FCGxE	565
E010-MxExE	248	EN403NxE	343	F019/008	221	FD0xE-	157
E010-UNCxEEx	254	EN404NxE	340	F025	237	FDCxE	534
E010-UNFxEEx	254	EN405NxE	337	F050	032	FGxE	284
E011/BSF	249	ERW100	553	F050I	031	FGxE-AI	284
E011/BSW	249	EW152	502	F050U	031	FLxE	573
E011/M140X125B	248	EW154	502	F060	030	FP120	502
E011/M140X125MCB	248	EW207	502	F060I	028	FP144	503
E011/MC	249	EW210	502	F060V	029	FP166	503
E011/UNC	250	EW213	502	F090-	334	FP190	502
E011/UNF	251	ExAL	543	F121-	244	FP192	503
E011A	246	ExDC	543	F122-	244	FP194	502
E011-AxE	257	ExSC	543	F23xE	237	FPA120-	560
E011B	246	F001/10	235	F256-	188	FRFxE	550
E011-BSFxE	250	F001/20	235	F256/644	190	FSAxE	561
E011-BSFxE M	256	F002-	220	F256/648	190	FTRxE	572
E011-BSPxE	250	F002/6	221	F2GxE	287	FTxE-1000	135
E011-BSPxE M	256	F002/P	220	F300-	186	FTxE-2000	135
E011-BSWxE	249	F002/PL	220	F301-	186	FTxE-3000	135
E011-BSWxE M	256	F002-xL	220	F302-	186	FW008-	508
E011C	246	F002-xP	219	F303-	188	FW010-	507
E011D	246	F002-xPL	220	F304-	187	FW031-	507
E011-Ex	257	F005-	236	F306-	186	FW035-	507
E011-M140X125Ex	248	F006-	236	F307/16/22	189	FW505-	507
E011-MxE1	247	F007-	236	F308-	188	FxEAL	543
E011-MxE2	247	F008-	546	F32xE	287	FxEDC	543
E011-MxE	248	F008DC	546	F400-	187	FxE SC	543
E011-MxE M	255	F008SC	546	F401-	187	G001-	243
E011-MxE M2	255	F010	296	F402-	187	G002-	243
E011-MxE MC	255	F011-	219	F403-	190	G003-	243
E011-UMxE	257	F011/6	219	F404-	189	G005	290
E011-UNCxE	250	F011-xP	218	F405-	189	G006-	290
E011-UNCxE M	256	F015-	222	F406-	189	G007-	178



ART	PAG	ART	PAG	ART	PAG	ART	PAG
G008	290	HxAL	544	L006	486	M011-	142
G009	381	HxDC	544	L007	387	M011-xG	142
G030-	476	HxSC	544	L008	490	M012-	142
G090-	334	I002	296	L011	385	M013/0/100	273
G0x	167	I109	355	L012	385	M015S	240
GCMX	204	I217	354	L012/PIA	385	M018-	451
GCMxA	204	I306	354	L013	385	M019-	273
GI01/20	494	I340	353	L014	296	M019-x	273
GI01/32	494	IS25-ESx	370	L018-	233	M020	241
GI01/32AE	494	IS25-PHx	370	L018S	234	M021-	272
GL230-	501	IS25-PHxAS	370	L019-	234	M022-	272
GL320-	501	IS25-PZx	370	L019S	234	M023-	143
GL340-	501	IS25-PZxAS	370	L020	234	M024-	144
GL343-	501	IS25-TGx	370	L020-	234	M026-	272
GL345-	498	IS25-TXx	370	L020S	234	M027-	145
GL346-	501	IS50-ESx	370	L080	289	M028-	143
GL349-	498	IS50-PHx	371	L085	289	M028-xG	143
GL365-	499	IS50-PZx	371	L090A	288	M029	241
GL373-	498	IS50-TGx	371	L10AL6	545	M030	241
GL386-	500	IS50-TXx	371	L150	289	M032	240
GL396-	500	J140xL	355	L200	289	M033	272
GL398-	500	J140xN	355	LBx	258	M033-	272
GL503-	500	JN402NA	344	LN400N1/2A	343	M033-x	272
GL515-	499	JN403NA	343	LN400N1/4A	338	M034/120	146
GL516-	499	JN404NA	340	LN400N3/4A	344	M035	294
GL626-	501	JN405NA	337	LN400N3/8A	340	M036	241
GL642-	498	JxDC	545	LxDC	544	M038	172
GL650-	498	JxSC	545	LxSC	544	M040	112
GL722-	499	K001-	154	M001-	145	M040/CF	112
GL750-	500	k002-	154	M001-x	242	M040/CP	112
GL762-	499	KICAN	182	M001-xV	241	M040/D	112
GL764-	499	KISCLCR	178	M002-	242	M040/SA	112
GL814-	498	KISER	181	M002-xV	242	M040/SP	112
GL918-	500	KISNR	182	M003-	242	M040/ST	112
Gx	416	KISTCMT	178	M003-xV	242	M041	112
GxAL	544	KISTFCR	179	M003-xxV	242	M049-	158
GxDC	544	KITCKJ	175	M003-xxx	243	M049-xGBD	160
GxSC	544	KNUX	197	m004-	161	M049-xST	160
HP205	505	KVx	185	M005-	159	M050-	156
HP207	505	KxDC	546	M006-	450	M051-	157
HP601	505	KxSC	546	M007-	451	M055	270
HP603	505	L002-	386	M009-	273	M055/120	270
HT125	285	L005	486	M010-	273	M057/16	081

ART	PAG	ART	PAG	ART	PAG	ART	PAG
M059-	161	ML80A	294	P005	113	P033/03S	229
M060-	161	MSCx	547	P007-	286	P034-	229
M061	142	MSD4x	535	P008/102	073	P034/05S	230
M062	270	MSD6x	535	P009	416	P034/06S	230
M069	291	MSD7230/7.0	534	P010/41	210	P035-	230
M071	291	MSD8x	533	P010/51	210	P035/04S	230
M072	291	MTD4x	535	P011-	286	P036-	218
M080-	156	MTD6x	535	P012-L	113	P037-	218
M100	240	MTD7230/3.2	534	P012-LxP	113	P039	114
M101	241	MTFNBASE25/32	184	P012-N	113	P039/PR	114
M10AL6	545	MTFNx	181	P012-NxP	113	P045	209
M13x	442	MTP4x	535	P013	299	P046	209
M16x	536	MTP6x	535	P014	144	P049-	226
M218	240	MTP7x	534	P015	144	P04x	281
M300/B	442	MTP8x	533	P017	145	P050-	226
M312/C	240	MTP9x	533	P018-	172	P051-	226
M312/P	240	MVx	536	P019	132	P052-	231
M430/B	442	Mx	173	P020	114	P052/08S	231
M449-	158	MxDC	545	P020/P	114	P056-	218
M449-xGBD	160	MxSC	545	P021	113	P056/10S	218
M449-xST	160	N12DC6	545	P022-	118	P057	218
M505/B	443	N7x	258	P023-	212	P058-	210
M530-	144	N7x1	258	P023/19	214	P058/170	210
M540/BT	443	NASx-A	552	P023/25	214	P061	211
MBGxA	537	NASx-C	552	P023-xC	212	P062	210
MBGxC	537	NASx-Z	552	P023-xL	213	P063-	226
MBx	536	NATx	552	P023-xL1	213	P064-	216
MCDxZ	547	NTxA	575	P023-xL2	213	P064/19A	216
MCG2050/06G	537	NTxZ	575	P023-xL3	214	P064/25A	216
MCGxA	537	NWS100	553	P024/06	480	P065-	215
MCGxC	537	NWS100/M	553	P024/15	480	P067	215
MCGxS	537	NxSC	545	P028-	118	P068	211
MCLNBASE25/32	184	OFEXx	201	P029-	118	P069	215
MCLNx	180	OFEXxA	201	P031-	228	P075	292
MD01	297	ONMxxA	202	P031/03S	228	P076-	227
MDAxZT	547	P001/04	118	P031/05S	229	P076/006S	228
MDFx	548	P001/10	117	P031/06P	228	P076/008S	228
MDUx	547	P001/12	117	P031/06S	229	P076-Gx	227
MFDxZ	547	P001/20	117	P031-xL	228	P076-Gx400	227
MFDxZC	547	P001/30	116	p032-	167	P076-Px	227
MFGx	563	P001/45	116	P032/18P	167	P07x	153
MGx	536	P001/75	116	P032/7P	167	P080	292
ML40	294	P002	113	P033-	229	P100/250	173



ART	PAG	ART	PAG	ART	PAG	ART	PAG
P101-	173	PI453x	350	RFF100	563	S004	298
P20x	286	PIF1	365	RFPx	551	S005	391
P30x	286	PLV175	565	RFTx	550	S005/R	391
P340	168	PMEx	570	RGFx	562	s007-	165
P350	168	PN402Nx	344	RGMx	549	S008/M	127
P40VD	414	PN403Nx	343	RGPx	550	S009	093
P440	168	PN404Nx	340	RGTx	549	S013	127
P444-	159	PN405Nx	337	RI40x	355	S014-	165
P450	168	PNS	565	RICAPCLN	184	S015	093
P4CS	168	PPSx	570	RICAPSSN	184	S017	128
P770-	153	PR16/10P	166	RICAPTGN	184	S018	371
P880/06S	364	PR20/12P	167	RLAx-RD-MID	267	S019	122
P881-	364	PR25/15P	167	RLAx-RS-MID	267	S022-	382
P881/06S	364	PSSNx	177	RLFx	550	S023	065
P882-	364	PSV-F	414	RLMx	551	S024	122
P883-	364	PSV-M	414	RLPx	551	S026-	238
P886-	364	PTGNx	177	RLTx	551	S026/06-20S	238
PARx	560	PVC300	497	RMTx	549	S026/06-20SM	238
PAS-	562	PVC300/125	497	RN4023NA	344	S027	126
PAV	414	PWLNRKIT	184	RN4032NA	343	S027ATV	126
PC40	168	PWLNx	178	RN4034NA	343	S029	126
PC40/R	168	R001-	061	RN4043NA	340	S029P	126
PC4P	168	R002	300	RN4045NA	340	S035D	098
PC50	168	R008	298	RN4054NA	337	S035P	097
PC50/R	168	R015	124	RP100	506	S041/1	280
PCLNx	176	R0x	287	RP120	506	S041/2	280
PCR6338	574	R607	482	RP123	506	S042/1	279
PDBx	570	R608	482	RP124	506	S042/2	279
PDC1-	134	R609	482	RP126	506	S042/3	279
PDC2-	134	R60xA	482	RP127	506	S045	279
PDC4-	134	R60xB	482	RP133	506	S046	279
PDJNRKIT	184	R610	482	RPMTx	202	S047	278
PDJNx	177	RASx	571	RPW090	552	S048-	282
PDMx	570	RCLx	572	RSAx	572	S049	278
PDVx-M14	570	RCSx	573	RSRx	571	S050-	281
PFBx	567	RDHTx	202	RSSx	571	S051	281
PFLx	570	REAx-FD	265	RTFx	572	S051-	282
PFSx	567	REAx-FS	265	Rx	267	S052/2	278
PG707-	505	REAx-RD	266	S001	238	S052/3	278
PG760-	505	REAx-RD-MID	266	S002	390	S052/4	278
PI401x	355	REAx-RS	266	S002/E100	390	S054	278
PI402x	351	REAx-RS-MID	266	S002/E200	390	S055	279
PI403x	350	REGx-FS	267	S002/E300	390	S056-	283

ART	PAG	ART	PAG	ART	PAG	ART	PAG
S057/060S	283	SCFx	554	SNMGxM35	198	T004-	153
S057/125	283	SCGx	556	SNMXx	203	T005	269
S058	283	SCLCx	179	SNRx	182	T006	269
S06x	281	SCLCxE	175	SP01-	508	T007-	269
S075-	467	SCMTx	197	SP02-	508	T008	152
S091-	276	SCMTxA1	197	SP03-	508	T009	277
S0x	237	SCMTxA2	197	SP04-	509	T00A1	171
S100	173	SCMTxA3	197	SP05-	509	T00A1/PP	171
S108	348	SCRx	555	SP06-	509	T00Ax	171
S110	300	SCSx	552	SP07-	509	T00Ax-PP	171
S111	300	SDJcX	176	SPA115/M14	570	T00x	170
S169	562	SDUCx	180	SPIxZ	573	T00x-B	170
S179	349	SEHTx	202	SPKNx	203	T00x-D	170
S2/800	138	SEHTxA	202	SPMRx	198	T00x-LC	170
S328	347	SEHXx	203	SPUN13P	070	T00x-S	170
S383	065	SEHXxA	203	SR44W	402	T010-	169
S401/00	476	SEKNx	202	SRFx	554	T011	270
S401/01	476	SERx	182	SRGx	555	T012-	148
S401/02	476	SFFx	548	SRRx	554	T013	151
S401/03	476	SFGx	556	SRRx-M14	554	T014G	151
S401/04	476	SFPx	557	SSSCRx	179	T015	152
S401/05	477	SFRx	557	SSSCxE	176	T015/E	152
S401/06	477	SGCx	574	ST1Ax	208	T016/100	147
S401/07	478	SGFx	548	ST1AxC	209	T017/100	147
S401/08	477	SGIH	183	ST1AxR10	208	T018/330	153
S401/09	477	SGRx	556	ST1AxR13	208	T018/350	152
S401/10	477	SGTBK	183	ST2Ax	217	T021-	169
S401/11	477	SI40N006	356	ST45-	156	T032	047
S401/12	478	SI413M006	353	ST45-xL	156	T032DA	046
S401/13	478	SI423M006	353	STAFCKJNL	184	T034/065	072
S401/14	478	SI4E1N008	355	STAFCKJNR	184	T034/105	072
S401/15	478	SI4E2N008	355	STFCx	180	T041	046
S401/16	478	SI4E3N013	353	STFx	554	T041DA	045
S503	065	SMCx	557	STGCx	175	T044/230V	034
S510	065	SN4E3C015	345	STGx	556	T044/400V	034
S520	346	SN4E4C013	345	STRx	555	T045	038
SA01/A	104	SN4E5C012	345	SVJBx	176	T046	038
SA01/C	104	SN4P3N027	347	SWS100	553	T047/230V	034
SA01/F	105	SNGx	555	SWS100/M	553	T047/400V	034
SA01/TR	104	SNMGx	197	Sx	133	T047/400VDA	033
SA01-CTRx	100	SNMGxF15	198	T001-	148	T048x	276
SALx	561	SNMGxF25	198	T002-	149	T049x	276
SCDx	560	SNMGxM25	198	T003-	269	T050	292



ART	PAG	ART	PAG	ART	PAG	ART	PAG
T051	292	T609	483	TM01/011	431	TNMGxF25	200
T052/400V	037	T660	022	TM01/012	431	TNMGxM25	200
T052/400VDA	037	T660I	022	TM01/013	431	TNMGxM35	200
T053	293	T700	021	TM01/014	431	TPKNx	203
T054	294	T700V	021	TM01/015	431	TPMRx	200
T055	295	T750	020	TM01/016	431	TR01/180	043
T056/TP01	295	T750I	020	TM01/017	431	TR01/200	042
T056/TP02	295	T900	019	TM01/018	432	Tx	173
T056/TP03	295	T900I	019	TM01/019	432	U003	106
T057	296	T940/230V	017	TM01/020	432	U004	106
T058	036	T940/230VI	016	TM01/021	432	UNCD-	559
T059/16V	036	T940/230VI3A	016	TM01/022	432	UNFxA	559
T059/28V	035	T940/400V	017	TM01/023	433	UNPxA	559
T061A	035	T998/230V	014	TM01/024	433	V002	297
T062	045	T998/230V3A	014	TM01/025	433	VBMTx	200
T063	295	T998/400V	014	TM01/026	433	VBMTxA	200
T064	294	T998/400V3A	014	TM01/027	433	VDAx	568
T066	044	T998/400VI3A	013	TM01/028	433	VDFxA	563
T068	294	T999/230V	015	TM01/029	433	VDGxA	568
T069/400V	012	T999/230V3A	015	TM01/030	433	VDLX	566
T069/400V3A	012	T999/400V	015	TM01/031	434	VDRx	569
T069/400VI3A	011	T999/400V3A	015	TM01/032	434	VDTx	569
T070/400V3A	010	TCMTx	198	TM01/033	434	VDZx	569
T070/400V3A15	008	TCMTxA	199	TM01/035	434	VITECKJN	184
T070/400VI3A	009	TDV	571	TM01/036	434	VLA200	565
T071	048	TEV120	571	TM01/037	434	VSCx	560
T072	048	TGx-AE	284	TM01/038	434	VSPx	566
T072DA	047	TH250	467	TM01/039	434	VT00440	190
T073	032	TH500	467	TM01/040	435	W021PA	463
T073DA	033	TH601A	465	TM01/041	435	W021PG	463
T075I	007	TH602A	465	TM01/042	435	W021PN	463
T080F	006	TH901A	465	TM01/043	435	WNMGx	199
T088	183	TIPAx	163	TM01/044	432	WNMGxM25	199
T089	183	TIPDx	164	TM01/045	432	WNMGxM35	199
T092-	265	TM01/001	430	TM01/046	432	WSSP	190
T09x	183	TM01/002	430	TM01/050	435	x-1000	135
T0Ax	171	TM01/004	430	TM01/052	435	x-2000	135
T0Ax-D	171	TM01/005	430	TM01/053	435	x-3000	135
T100-	265	TM01/006	430	TM01/100	435	ZSAx	569
T145	044	TM01/007	430	TM01/110	436	ZSD8x	533
T200	172	TM01/008	430	TM01/120	436	ZTD8x	533
T201	172	TM01/009	430	TNMGx	199		
T338-	173	TM01/010	431	TNMGxF15	199		

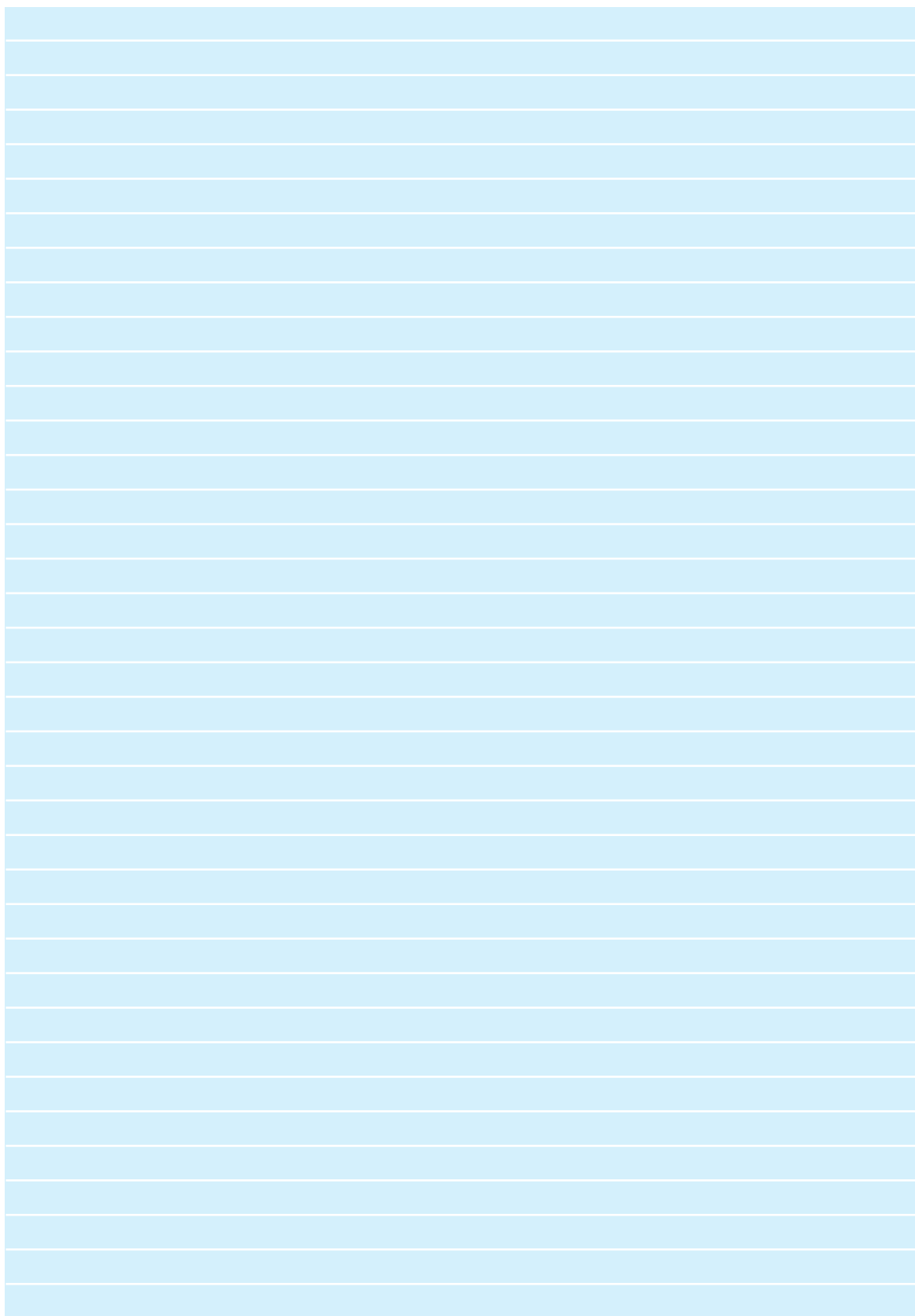

A large rectangular area filled with horizontal light blue lines, resembling a sheet of lined paper. The lines are evenly spaced and extend across the width of the page, leaving a small margin at the top and bottom.

1. GENERAL REGULATIONS

Fervi SpA is a company that markets its own products such as machine tools, accessories, measurement instruments and products generically called hardware items. The general conditions of sale, reported below, are undertaken by Fervi SpA and are considered valid for any order received and to be applied to all sales of products by the same.

Fervi reserves the right to modify these general conditions of sale at any time and without prior notice. Any amendments, exemptions and/or particular conditions in regards to these clauses deriving from the Client shall not be in any way binding for Fervi unless expressly agreed in writing and duly signed by both parties.

2. DEFINITIONS

For the purposes of these general conditions of the contract of sale (hereinafter referred to as "Conditions of Sale"), the following terms are understood as follows:

- "Fervi/The Vendor": Fervi SpA;
- "Client(s)/Purchaser(s)": any company, body or registered entity that purchases Fervi products;
- "Product(s)": the goods produced, assembled, sold and/or distributed by Fervi;
- "Order(s)": each and any written request and/or offer of purchase of the products forwarded from the Client to Fervi by fax, email, sales representative or by any other means recognised by Fervi;
- "Sale(s)": each contract of sale concluded by Fervi and the Client, also through a sales representative;
- "Goods": quantity and type of product contained in the Client order;
- "Catalogue": illustrative volume of the Fervi products;
- "Returns": all products and goods returned by means of the procedure provided by Fervi
- "Trademark(s)": all of the trademarks of which Fervi is owner, title holder and/or licensee;
- "Intellectual Property Rights": all intellectual and industrial property right of Fervi including, without any limitation, the rights pertaining to licences for inventions, drawings or models, utility models, trademarks, logos, knowhow, technical specifications, data, whether registered rights or not, in addition to any application or registration relative to said right and every other right or form of protection of a similar nature or having an equivalent effect.

3. PRODUCTS AND MODIFICATIONS

The weights, dimensions, prices, colours and any other characteristic and date even of a figurative nature inserted in the catalogue, price lists, brochures, illustrations, flyers, offers, advertising material in general and/or other illustrative documents by Fervi, are approximate indications and are not in any case binding for Fervi.

The Vendor reserves the right to vary its products' technical or manufacturing data at any time and without prior notice and to perform any modifications considered necessary.

The Vendor is not required to make modifications that have subsequently been agreed upon to an order should the products have been already produced or be in the process of production.

The type of products and their availability may vary at any time without this incurring any liability for Fervi.

Any modification to the products by Fervi does not give the client grounds to file complaints in any case.

4. PRICES

The price is expressed in Euros and the price for each individual product is indicated in the catalogue and/or on the Fervi website; it is merely indicative and can therefore be subject to change without prior notification to the client.

In the event of promotional offers by Fervi, the price will be that indicated in these offers and may be subject to change for certain products, where specified.

Unless agreed otherwise in writing between the parties, the goods will be invoiced at the prices applicable at the time of the order.

The prices are net of VAT, taxes, tolls, customs and tax charges or any type arising from the contract which are the exclusive responsibility of the Client.

The cost of packaging is included in the price while shipping costs are always excluded.

5. ORDERS

These conditions of sale are read and approved by the Client upon the submission of the order, which is in any case received by Fervi with the clause "Subject to Company Approval."

The order must be defined in all its parts and all of the technical and administrative indications must be completed, including any tax relief. The item code and the relative quantities must be specified.

The minimum order quantities for each item are indicated in the catalogue/website.

Orders that do not correspond to this, or multiples of these amounts, will be automatically adjusted by Fervi without prior client authorisation.

Unless otherwise agreed in writing between the parties, the order is deemed irrevocable pursuant to and in accordance with Article 1331 of the Italian Civil Code.

Fervi reserves the right, at its sole discretion, to refuse or accept, in whole or in part, any variations to the order proposed by the purchaser after the submission of the order.

Fervi confirms that the client is prohibited from unilaterally withdrawing from an order and sale. In the event that the client withdraws from the order confirmed by Fervi, the client is liable in any case for the full amount of the goods.

6. ORDER ACCEPTANCE/CONFIRMATION

Upon submission of the order, the client remains committed to the prices and conditions indicated in the catalogue applicable at the time of the order.

Fervi can accept the order by shipping the goods pursuant to Article 1327 of the Italian Civil Code, without any obligation to notify the client, notwithstanding the provision in the 2nd paragraph of the aforementioned article. Fervi has the right, following the acceptance of the order, if deemed appropriate, to send the client an order confirmation by way of acceptance.

7. PARTIAL PROCESSING OF THE ORDER

Fervi reserves the right to process the order in full or in part or in various batches, taking into account the availability of products, without guaranteeing the final balance.

The remaining products will be sent to the Client, based on Fervi's availability, in accordance with the terms and conditions agreed upon by the parties in writing.

8. RETURNS

The Client is required to inform Fervi (fax: +39 059 763 037; email: assistenza@fervi.com) if the goods are returned within 8 days of receipt.

Fervi shall accept any return of goods only if approved and authorised in advance by the vendor in writing and the relative costs are fully incurred of the client.

In any case the reason for the return, the authorisation number received and the purchase invoice must be specifically indicated in the accompanying document.

The goods must be returned in their original packaging.

Unauthorised returns or returns performed using different methods from those agreed upon will not be accepted by Fervi and will be returned to the clients at their own expense.

Damaged, altered and/or modified products will not be accepted.

The aforementioned returns must be sent to Fervi SpA, Via del Commercio No. 81, 41058 Vignola (MO) Italy.

9. CLAIMS/COMPLAINTS/NON-COMPLIANT PRODUCTS

The client, through the people assigned to receive the goods, is required to check the goods, the state of the packaging or any other faults that are evident at the time of delivery in the presence of the transporter in addition to verifying the integrity of the parcels delivered and their corresponding number.

If the packaging is damaged, goods are missing or other faults are detected, the purchaser is required to file a claim in writing with the transporter immediately upon receipt of the goods at the designated space provided on the transporter slip, specifying the grounds for the claim.

The aforementioned slip, duly signed with a legible signature, must be delivered directly to the transporter.

Upon completion of the aforementioned procedure, the client is required to inform the vendor about problems in writing by fax or email, upon penalty of expiry, within 4 days from the date of receipt of the goods, indicating the order number and the date of receipt of the goods.

Any complaints regarding defects that cannot be identified through a diligent check upon receipt of the goods (visible faults) must be reported in writing to the vendor by fax or email, under penalty of expiry, within 15 days from the date the fault is discovered and, in any case, no later than twelve months from the date of receipt of the goods.

The complaint must, in any case, specify the fault encountered, the products to which it refers and the details of the purchase invoice.

If the products delivered do not comply with the order, the purchaser is required to inform the vendor, in writing, under penalty of expiry, within 8 days from the date of receipt of the goods in order to arrange the replacement.

The goods returned must be accompanied by the corresponding delivery slip with the words "goods non-compliant with order".

The return of the goods to Fervi by the purchaser, regardless of the reason, is in any case subject to written authorisation by the vendor, which will report the return method and schedule.

The goods must be returned in their original packaging, accompanied by the authorisation number received from Fervi.

Any complaints and/or disputes do not give the purchaser the right to suspend or, in any way, delay payment of the products that are the subject of the complaint and/

or dispute or other supplies.

Unauthorised returns and/or returns carried out in a method that differs to those agreed will not be accepted by Fervi and the goods will be returned to the client at the client's expense.

Product returns will not be accepted if products have been tampered with, altered, modified or are old or no longer offered by Fervi.

If the claim is not submitted in accordance with the methods and timeframes specified above, the products shall be considered compliant with those ordered by the client and the client is required to pay for the goods.

10. PAYMENT CONDITIONS/OWNERSHIP OF GOODS

Payments must be made in accordance with the methods and under the terms indicated in the invoice issued by Fervi.

The purchaser is not required to authorise any deduction or modification to the price, unless previously agreed upon in writing with the vendor.

The purchaser shall acquire ownership of the goods only upon full payment of the invoice issued by the vendor. The purchaser will, however, assume all risks pertaining to it at the time of delivery to the courier.

In the case of late payments, the vendor shall unilaterally modify the terms of any other supply and/or suspend execution until obtaining the appropriate guarantee of payment (i.e. surety or bank guarantee).

11. SHIPPING AND TRANSPORT

The client is solely responsible for shipping and transportation costs.

Fervi reserves the right to choose the carrier, to whom Fervi is not required to report the value of the goods. If the client intends to insure the shipment, it is required to expressly request this insurance upon placing the order, assuming payment of all relative charges.

The transfer of risk for the goods takes place upon their delivery to the carrier: consequently the goods always travel at the full risk and peril of the client, even in the event of carriage paid by Fervi.

Shipping of the goods, as well as any order confirmation is subject to a minimum order of €1000. If the client purchases goods directly from the sales desk at the Fervi Distribution Centre, the minimum order amount is reduced to €500. Direct shipping to Client's Customers is excluded.

12. DELIVERY TERMS

Any terms to process the order, where provided, are calculated for business days and are understood in any case as purely indicative, not mandatory or legally binding for Fervi.

Therefore, in consideration of the purely indicative nature of the terms indicated above, Fervi is not liable for damages caused directly or indirectly by the delayed execution or delayed or non-delivery of the goods.

Fervi shall not in any case be held liable for delayed or non-delivery resulting from acts of God or force majeure.

13. PRODUCT GUARANTEE/TECHNICAL COMPLIANCE

All Fervi products are covered by a manufacturer's guarantee and have all the certifications and technical compliance certificates required by law.

This guarantee is time-specific and applies to the specific product sold, excluding any other service such as any indemnity and/or compensation. This guarantee shall be applied to the product that has compliance issues and/or malfunctions not detected at the time of purchase, provided that said product is used correctly, with due diligence and with respect for its uses provided in any technical documentation, with strict compliance with the utility function as described in the manuals.

The aforementioned guarantee shall not, however, be applicable in the case of negligence or negligent product use and maintenance. In all cases, Fervi cannot be held liable for the use, applications and/or operations of the product by the client or assistant in the event of use for purposes other than and not related to those set forth in the catalogue and/or in the instructions for use/technical manual.

14. REPAIRS/TECHNICAL INTERVENTIONS/ASSISTANCE

Fervi also carries out technical assistance and repair centre services for its products.

Clients requiring interventions are required to submit their intervention request to Fervi in writing by fax or email, expressly indicating the reason for the request, the product type, the date of purchase and any other information necessary for the purpose of determining the intervention methods.

Fervi's assistance department, having examined the request, shall inform the client about the intervention to be conducted and the corresponding timeframes.

The intervention costs shall be calculated following receipt of the request and may vary based on whether the product has a valid guarantee or not.

The guarantee is effective on the date indicated on the purchase invoice. The requesting party is required to provide proof of guarantee by submitting the purchase document.

Fervi shall provide an estimate of the repair costs if the guarantee does not apply; if the guarantee is applicable, Fervi is liable for the intervention costs.

In any case, intervention is subjected to authorisation by Fervi: the client, therefore, may not send the material without Fervi's prior acceptance unless accepting the risk of incurring return costs.

The goods shall be returned by the clients at the Fervi warehouse at their own costs.

15. CHANGE TO CLIENT OWNERSHIP CONDITIONS

Fervi shall have the right to withdraw from the contract, in addition to suspending fulfilment of the obligations deriving from the sale of the products, at no charge if it becomes aware of any changes to the ownership conditions that put the products' performance at serious risk unless a suitable guarantee is provided. Fervi has this right if it becomes aware, for example and without this list being exhaustive, of a dishonoured checks or bills, or the initiation of legal, summary, ordinary or insolvency proceedings, including in tort proceedings, filed by the client.

16. INTELLECTUAL PROPERTY RIGHTS

The intellectual property rights are the complete and exclusive property of Fervi and their communication or use in connection with the Conditions of Sale does not result in any right or claim for the client.

The client is required in all cases to refrain from performing any act that is not in line with ownership of the intellectual property rights.

The client hereby declares that: Fervi is the exclusive owner of the intellectual property rights; the client shall refrain from using and registering trademarks that are similar to and/or could be confused with the trademarks that Fervi owns and/or holds the licence for; said client shall use the trademarks exclusively in compliance with Fervi instructions and exclusively for the purposes contained in these Conditions of Sale.

In all cases, the Fervi's products catalogue is, for all intents and purposes, protected by the copyright laws and, therefore, any reproduction and/or use not expressly authorised in writing is prohibited.

17. APPLICABLE LAW AND COMPETENT COURT

This contract is regulated by Italian law and for any dispute regarding its validity, interpretation or execution, the client accepts the jurisdiction of the Italian state and, in any case, the application of the Italian law in effect at the moment the dispute arises, in addition to the applicable norms on sales regulated by articles 1470 and the following of the Italian Civil Code. Any dispute arising involving the interpretation, application, execution, termination of the contract and/or these general conditions of contract, or in any way related thereof, shall be under the exclusive jurisdiction of the Court of Modena.

18. PERSONAL DATA PROCESSING

Fervi guarantees that the data provided on this contract shall be processed with the utmost confidentiality and in full respect for the regulations in effect on the protection of personal data (Legislative Decree of 30 June 2003, No. 196). In any case, processing this data follows the principles of correctness, lawfulness and transparency. All data is processed by Fervi, the data controller, in order to send the catalogue (considered pre-contractual activity), acquire, manage and process orders for the post-contractual activities and comply with the administrative, legal and tax obligations and requirements.

Data processing can be carried out both in hardcopy and through automated methods and instruments, located in and outside Italy and with electronic tools at the data controller's offices. Upon submitting the purchase order, the client is required to provide the data for administrative, legal and tax purposes and requirements.

Any refusal to provide the data will hinder the order processing. The data will not be circulated but may be distributed to Fervi employees, partners and consultants, parties who are legally permitted to accept them based on legal provisions, regulations and EU regulations and, as strictly necessary, share them with subjects that, for the purposes indicated herein, need to supply goods and/or perform services in relation to Fervi services or work. The data may be transferred to European Union countries and third party countries within the scope indicated above.

At any time, the client may exercise the rights pursuant to article 7 of the Legislative Decree No. 196/2003 or access personal data in order to learn about the use of said data, request a cancellation, correction, modification, update or integration or object to the processing by writing by sending notice to the Fervi offices at Via del Commercio No. 81, 41058, Vignola (Mo).

WARNING - ALWAYS CHECK THE INTEGRITY OF THE PARCELS AT THE TIME OF RECEIPT. IN THE EVENT OF DAMAGE, INCLUDE AN INTELLIGIBLE CLAIM ON OUR DELIVERY SLIP OR INVOICE. FERVISpa CANNOT BE HELD LIABLE FOR ANY DAMAGES CAUSED DURING TRANSPORT.

MINIMUM ORDER QUANTITY PER ITEM

All our products can be purchased in quantities of 1 (one) piece, with the exception of items with a specific indication, which can only be purchased in the minimum quantity indicated.

P023-

*CAT 42

STRAIGHT SHANK TWIST DRILL

FULLY GROUND, RIGHT HAND, SHORT LENGTH, TO CUT MATERIALS WITH RESISTANCE R= 800 N/MM2, TWIST DRILL HARDNESS HV= 770 ÷ 830

- PACKING OF 10* PIECES UNTIL Ø 7,90 mm
- PACKING OF 5* PIECES FROM Ø 8,00 mm

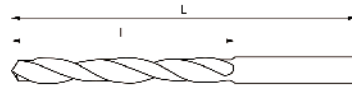

HSS DIN 338 135°

Art.	€	ø	L	l	Art.	€	ø	L	l	Art.	€	ø	L	l
P023/00.30	€ 0,33	0.30 mm	19 mm	3 mm	P023/03.80	€ 0,71	3.80 mm	75 mm	43 mm	P023/07.80	€ 2,04	7.80 mm	117 mm	75 mm
P023/00.35	€ 0,33	0.35 mm	19 mm	4 mm	P023/03.90	€ 0,71	3.90 mm	75 mm	43 mm	P023/07.90	€ 2,04	7.90 mm	117 mm	75 mm
P023/00.40	€ 0,33	0.40 mm	20 mm	5 mm	P023/04.00	€ 0,83	4.00 mm	75 mm	43 mm	P023/08.00	€ 2,70	8.00 mm	117 mm	75 mm
P023/00.45	€ 0,33	0.45 mm	20 mm	5 mm	P023/04.10	€ 0,79	4.10 mm	75 mm	43 mm	P023/08.10	€ 2,31	8.10 mm	117 mm	75 mm
P023/00.50	€ 0,33	0.50 mm	22 mm	6 mm	P023/04.20	€ 0,79	4.20 mm	75 mm	43 mm	P023/08.20	€ 2,31	8.20 mm	117 mm	75 mm
P023/00.55	€ 0,33	0.55 mm	24 mm	7 mm	P023/04.25	€ 1,13	4.25 mm	75 mm	43 mm	P023/08.25	€ 3,45	8.25 mm	117 mm	75 mm
P023/00.60	€ 0,33	0.60 mm	24 mm	7 mm	P023/04.30	€ 0,83	4.30 mm	80 mm	47 mm	P023/08.30	€ 2,31	8.30 mm	117 mm	75 mm
P023/00.65	€ 0,33	0.65 mm	26 mm	8 mm	P023/04.40	€ 0,83	4.40 mm	80 mm	47 mm	P023/08.40	€ 2,31	8.40 mm	117 mm	75 mm
P023/00.70	€ 0,33	0.70 mm	28 mm	9 mm	P023/04.50	€ 0,98	4.50 mm	80 mm	47 mm	P023/08.50	€ 3,38	8.50 mm	117 mm	75 mm
P023/00.75	€ 0,33	0.75 mm	28 mm	9 mm	P023/04.60	€ 0,97	4.60 mm	80 mm	47 mm	P023/08.60	€ 2,69	8.60 mm	125 mm	81 mm
P023/00.80	€ 0,33	0.80 mm	30 mm	10 mm	P023/04.70	€ 0,97	4.70 mm	80 mm	47 mm	P023/08.70	€ 2,69	8.70 mm	125 mm	81 mm
P023/00.85	€ 0,33	0.85 mm	30 mm	10 mm	P023/04.75	€ 1,13	4.75 mm	80 mm	47 mm	P023/08.75	€ 3,68	8.75 mm	125 mm	81 mm
P023/00.90	€ 0,33	0.90 mm	32 mm	11 mm	P023/04.80	€ 0,97	4.80 mm	86 mm	52 mm	P023/08.80	€ 2,69	8.80 mm	125 mm	81 mm
P023/00.95	€ 0,33	0.95 mm	32 mm	11 mm	P023/04.90	€ 0,97	4.90 mm	86 mm	52 mm	P023/08.90	€ 2,69	8.90 mm	125 mm	81 mm
P023/01.00	€ 0,75	1.00 mm	34 mm	12 mm	P023/05.00	€ 1,05	5.00 mm	86 mm	52 mm	P023/09.00	€ 3,53	9.00 mm	125 mm	81 mm
P023/01.10	€ 0,39	1.10 mm	36 mm	14 mm	P023/05.10	€ 1,21	5.10 mm	86 mm	52 mm	P023/09.10	€ 2,97	9.10 mm	125 mm	81 mm
P023/01.20	€ 0,39	1.20 mm	38 mm	16 mm	P023/05.20	€ 1,21	5.20 mm	86 mm	52 mm	P023/09.20	€ 2,97	9.20 mm	125 mm	81 mm
P023/01.25	€ 0,75	1.25 mm	38 mm	16 mm	P023/05.25	€ 1,43	5.25 mm	86 mm	52 mm	P023/09.25	€ 4,13	9.25 mm	125 mm	81 mm
P023/01.30	€ 0,39	1.30 mm	38 mm	16 mm	P023/05.30	€ 1,21	5.30 mm	86 mm	52 mm	P023/09.30	€ 2,97	9.30 mm	125 mm	81 mm
P023/01.40	€ 0,39	1.40 mm	40 mm	18 mm	P023/05.40	€ 1,21	5.40 mm	93 mm	57 mm	P023/09.40	€ 2,97	9.40 mm	125 mm	81 mm
P023/01.50	€ 0,68	1.50 mm	40 mm	18 mm	P023/05.50	€ 1,35	5.50 mm	93 mm	57 mm	P023/09.50	€ 3,75	9.50 mm	125 mm	81 mm
P023/01.60	€ 0,44	1.60 mm	43 mm	20 mm	P023/05.60	€ 1,27	5.60 mm	93 mm	57 mm	P023/09.60	€ 3,33	9.60 mm	133 mm	87 mm
P023/01.70	€ 0,44	1.70 mm	43 mm	20 mm	P023/05.70	€ 1,27	5.70 mm	93 mm	57 mm	P023/09.70	€ 3,33	9.70 mm	133 mm	87 mm
P023/01.75	€ 0,60	1.75 mm	46 mm	22 mm	P023/05.75	€ 1,58	5.75 mm	93 mm	57 mm	P023/09.75	€ 4,43	9.75 mm	133 mm	87 mm
P023/01.80	€ 0,44	1.80 mm	46 mm	22 mm	P023/05.80	€ 1,27	5.80 mm	93 mm	57 mm	P023/09.80	€ 3,33	9.80 mm	133 mm	87 mm
P023/01.90	€ 0,44	1.90 mm	46 mm	22 mm	P023/05.90	€ 1,27	5.90 mm	93 mm	57 mm	P023/09.90	€ 3,33	9.90 mm	133 mm	87 mm
P023/02.00	€ 0,60	2.00 mm	49 mm	24 mm	P023/06.00	€ 1,43	6.00 mm	93 mm	57 mm	P023/10.00	€ 4,05	10.00 mm	133 mm	87 mm
P023/02.10	€ 0,48	2.10 mm	49 mm	24 mm	P023/06.10	€ 1,31	6.10 mm	101 mm	63 mm	P023/10.25	€ 5,60	10.25 mm	133 mm	87 mm
P023/02.20	€ 0,48	2.20 mm	53 mm	27 mm	P023/06.20	€ 1,31	6.20 mm	101 mm	63 mm					

Some items also include quantity and packaging information. This information is designed to facilitate storage and stocking of material and **should not be considered binding.**

MINIMUM ORDER €

The **minimum billable is €1.000** (one thousand Euros, excluding VAT – Article 11 of the Fervi SpA General Conditions of Sale.

This amount is reduced to €500 (five hundred Euros), excluding VAT, if the client picks up the material directly from the sales desk at the Fervi Distribution Centres – see Article 11 of the Fervi SpA General Conditions of Sale.

