

INNOVATIVE TOOLS EXPERTS



DIAGNOSTIC



CHASSIS



SIMULATOR



VIDEOSCOPE



MITYVAC



PRESSURE DIAG

HU35025

Kit includes:

- 7" Color TFT display with resistive touch panel
- Sensor -1 to 3bar
- Sensor 0 to 300bar
- Universal Diesel Compression Adaptor
- Universal Petrol Compression Adaptor
- 9 specific professional quick coupling adaptors
- Vacuum adaptors
- Battery: LiPo 3,7V / 2000mA
- PC connection by USB port
- ABS enclosure with rubber bumper (Hubitools design)

REPLACES **DOZENS** OF
STANDARD DIAGNOSIS KITS
IN JUST **ONE** SET

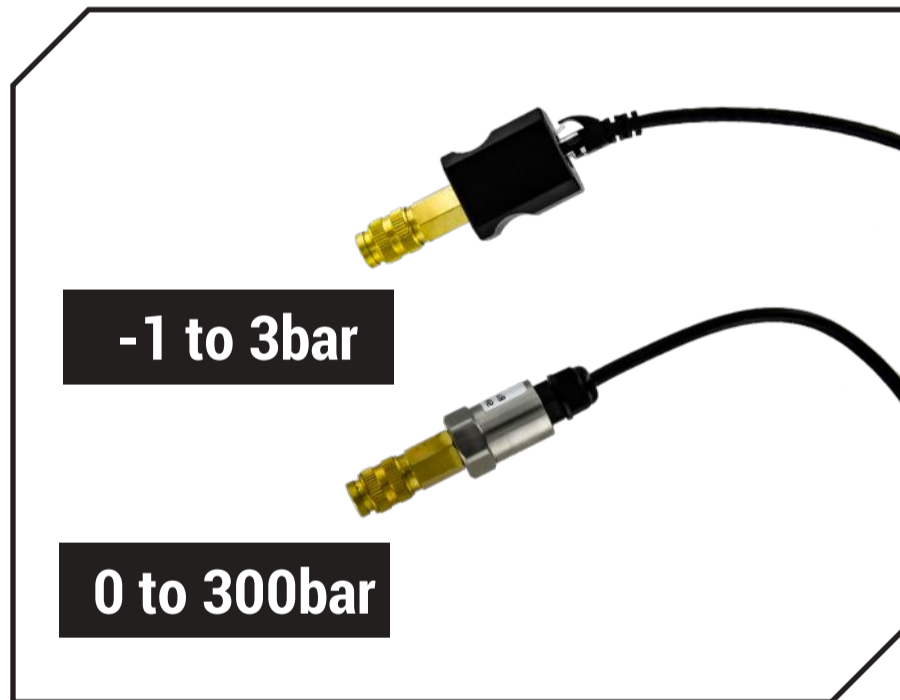

ALL APPLICATIONS YOU NEED



Vacuum pressure



AdBlue pressure



Compression PETROL
& DIESEL



Oil pressure



Cooling system
pressure



Particle filter pressure



Fuel low pressure



Turbo pressure

SAVE, EXPORT, PRINT
AND SHARE YOUR **RESULTS!**



DIESEL GLOW PLUG COMPRESSION ADAPTER

HU35039

- Universal false glow plug to be mounted in place of the OEM glow plug to perform a Diesel compression test
- Simply select the right thread adaptor and the right sealing cone to copy the OEM glow plug

Kit includes :

- 4 x Screw-in adaptor (M8x1, M9x1, M10x1 and M10x1,25)
- 4 x Sealing cones (Ø 8.2/60°, Ø 8.2/90°, Ø 6.8/90°, Ø 6.8/120°)



NEW



THIS KIT REPLACES **DOZENS OF COMPRESSION GLOW PLUGS ADAPTERS**

DIESEL INJECTOR COMPRESSION ADAPTER

HU35037

- Universal false injector to be mounted in place of the OEM injector to perform a Diesel compression test
- Copy the length and sealing part of the OEM injector using the different heads and spacers
- Can be used either with the bridge included or with the OEM bridge
- Also works for engines with one bridge for 2 injectors

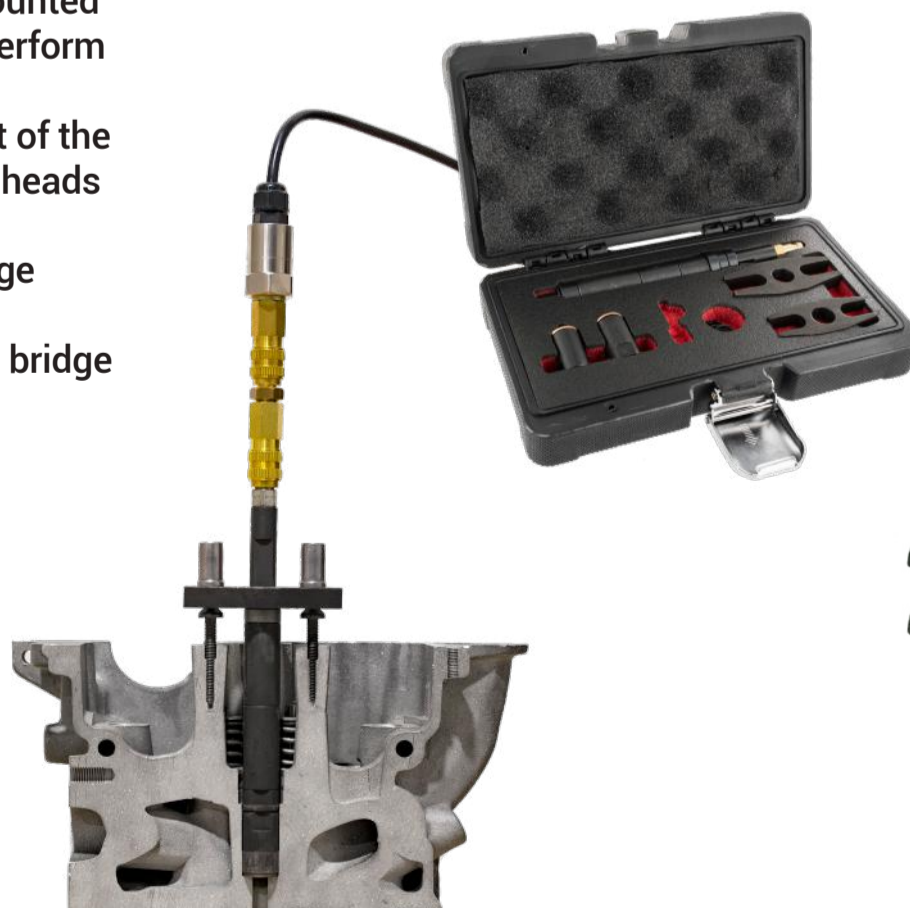

NEW



SCHRADER ADAPTERS

- These adapters allow for fuel low pressure testing of engines using Schrader type connectors inlets for pressure testing (Ford, GM, ..)
- Also allow for cooling system pressure testing on cars equipped with Schrader type coolant bleeding valve

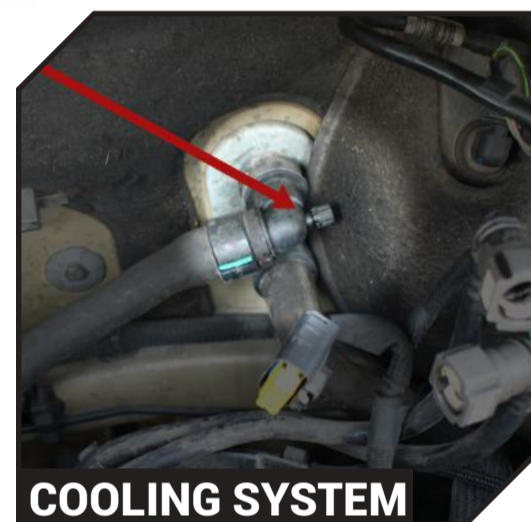
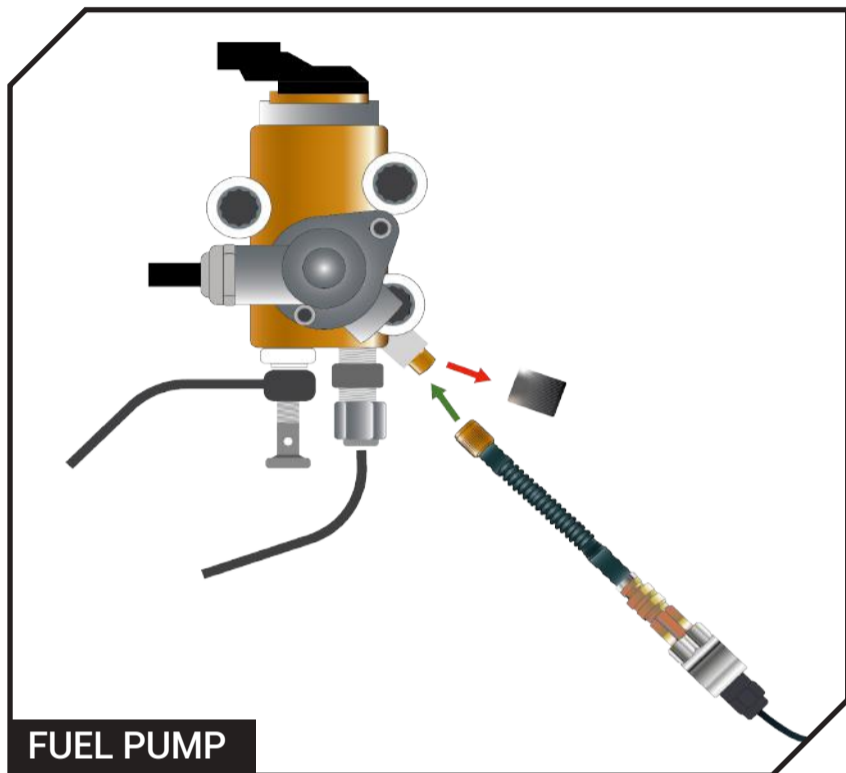

COOLING SYSTEM ADAPTER

HU35025-13

- This adapter can be used either along with the T adapters already included in the Pressure Diag or alone to perform a pressure test of the cooling system
- Its design reproduces the OEM connection allowing it to connect to various spots in the cooling system. It help locate an issue by bypassing some elements
- Example of use : connect to the line that goes to :
EGR coolant port, radiator pressure release port, controlled thermostat port, coolant reservoir port,...

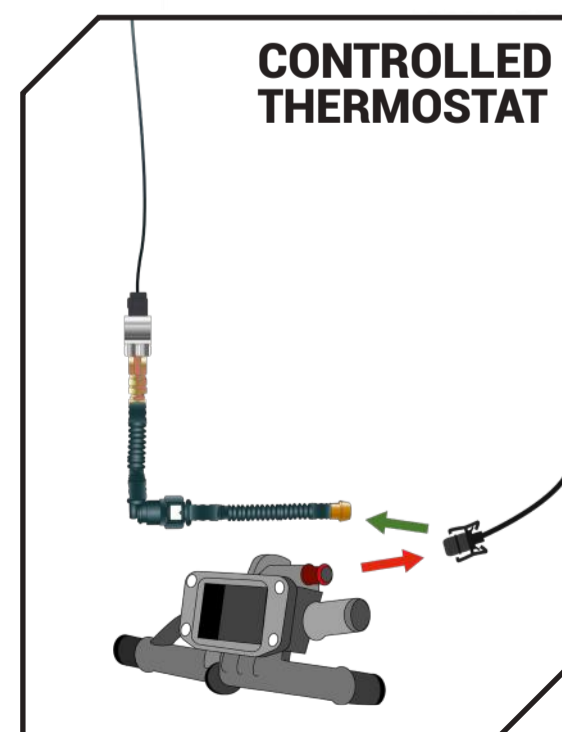

GASOLINE HIGH PRESSURE ADAPTERS

HU35029

- This kit allows, using the 0-300bars sensor included in the Pressure Diag, to test the Gasoline High pressure of most popular gasoline (Petrol) engines (FSI, TFSI, TCe, T-Jet, Etc.) Both using the sensor location or the dedicated plug location
- Kit includes the following adapters :

| | |
|---------------|---------------|
| HP1 = M12x150 | HP4 = M10x100 |
| HP2 = M12x125 | HP5 = M8x100 |
| HP3 = M14x150 | |



ONLY UNIVERSAL KIT IN THE MARKET

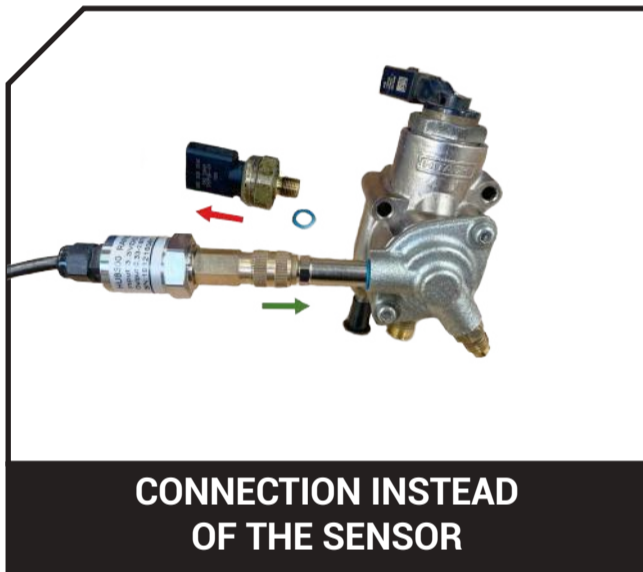

CONNECTION INSTEAD OF THE SENSOR

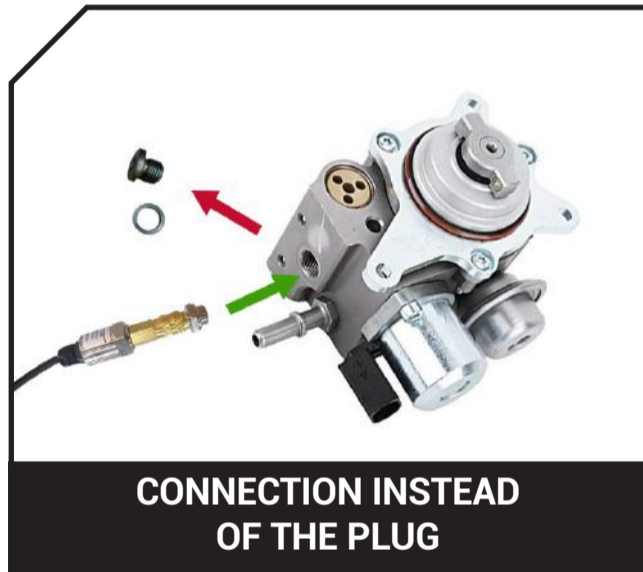

CONNECTION INSTEAD OF THE PLUG

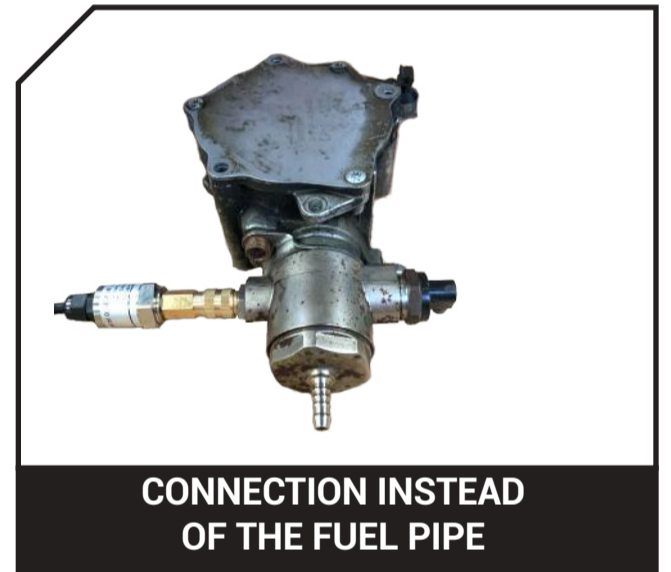

CONNECTION INSTEAD OF THE FUEL PIPE

UNIVERSAL T ADAPTERS (2PCS)

HU35041

- Those T-Fitting "Barb" adapters allow you to connect to any soft low pressure line on cars, trucks, tractors, etc easily when there is no quick connector to fit the plastic T's included in the Pressure Diag kit
- Fit soft lines from internal diameter from 6mm to 15mm
- Used along with the electronic sensors included in the Pressure Diag

NEW



Max : 15 mm



Min : 6 mm

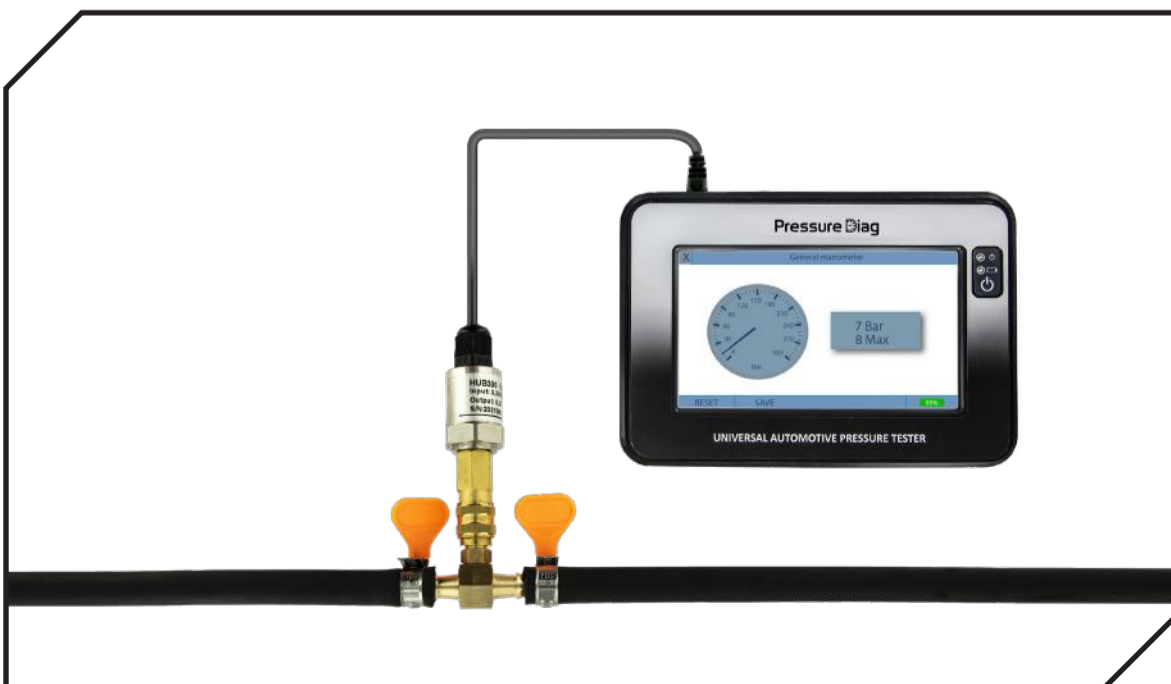

DIESEL HIGH PRESSURE KIT

HU35026

- Easily and safely test the diesel common rail pressure
- The mechanic will be able to safely test the diesel common rail pressure, both in line in serie with engine running and for direct pump pressure (Cranking the engine)
- Unlike simply having the pressure information with the sensor of the car (this sensor may have an issue), our set provides all the hardware (special sensor, plugs, hoses) to perform a very precise and accurate test in association with our digital Pressure Tester. The hoses in the set allow measurement and diagnoses of most usual common rail engines
- Kit includes a 2000bar sensor, a sensor plug for direct pump pressure, 2x M12 x 150 hoses for most common applications and a retrieving reservoir

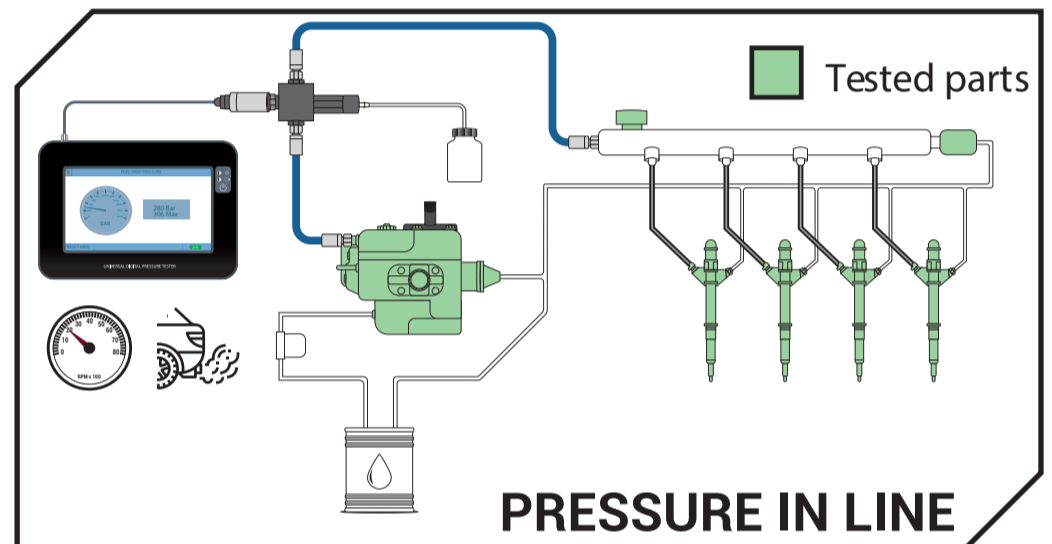
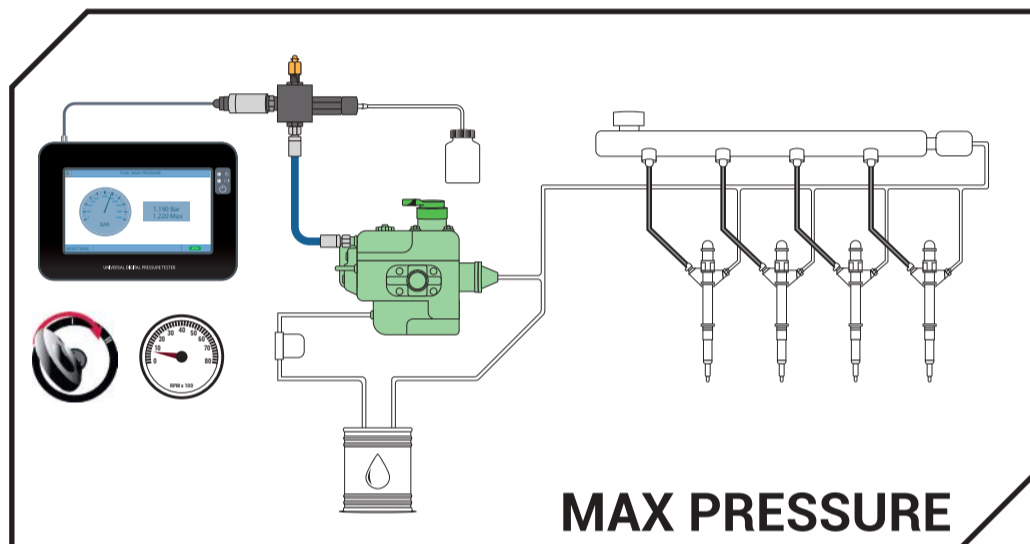

LAST GENERATION DIESEL ADAPTERS

HU35028

- This set, in association with the diesel high pressure kit will allow to testing the diesel high pressure of most popular cars in the market. (Delphi, Siemens, Bosch and Denso pumps)
- One end of the adapters always has a M12x150 thread to fit our hoses. The other ends are :
 - M12x125 (2x)
 - M14x150 (2x)
 - M14x100 (1x)
 - M16x100 (1x)

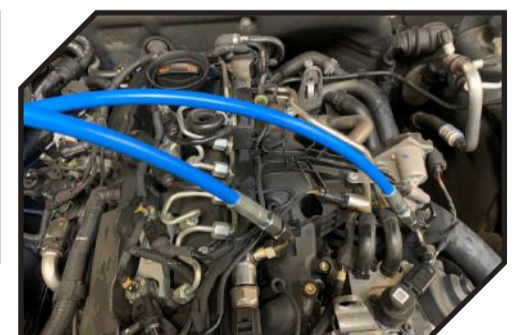
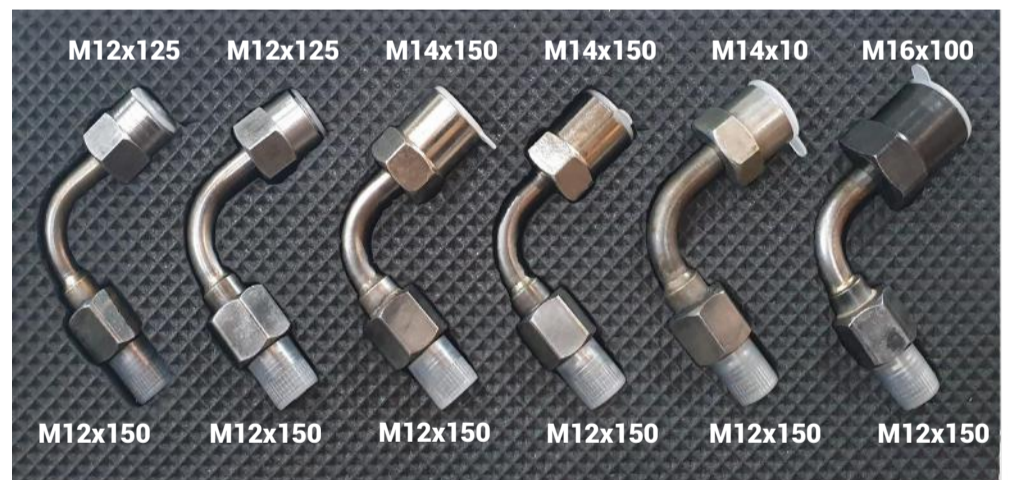

COMMON RAIL DUMMY REGULATOR SET

HU35031

- This set, used in association with Diesel high pressure kit, allows bypassing of the pump's regulator and measurement the pressure to diagnose any regulator or pump issue
- After observing the weak pump pressure : Simply remove the regulator, and choose the right dummy plug to bypass and seal the port. If the pressure comes back to normal, the regulator causes the loss of pressure. If the pressure stays too low, the pump is defective. This test is recommended by manufacturers of high-pressure pumps
- Kit includes 8 different dummies to seal any regulator ports



COMMON RAIL CAPS SET

HU35030

- Used in association with Diesel high pressure kit, this set will allow the closure of the injector's fuel inlets directly on the common rail. The purpose of this operation is to identify if an injector is leaking or not
- Works for 3, 4, 5 and 6 cylinders engines
- Kit includes 6x M12x150 plugs and 6x M14x150 plugs



CYLINDER LEAKAGE TESTER

HU35027

Do you know what downsizing is?
Producing smaller engines that generate the same power!
Problems: Even small differences in compression can significantly affect the behavior of these engines.
The cylinder leakage test is therefore unavoidable !

- Connects either directly to the Pressure Diag or to the pressure gauge, which is included, for stand-alone use
- Ideal for warranty and traceability purposes with the ability to save and print the test reports
- Delivered with M14, M12 and M10 petrol fittings
- Connects to all Pressure Diag gasoline and diesel compression fittings

NEW



CYLINDER LEAK TEST FOR A BETTER COMPRESSION DIAGNOSTIC

THE COMPRESSION TEST WILL QUICKLY TELL YOU WHICH CYLINDER IS THE PROBLEM

THE LEAK TEST WILL QUICKLY TELL YOU WHAT THE PROBLEM IS (INTAKE, EXHAUST,..)

SAVE AND SHARE THE TEST RESULTS

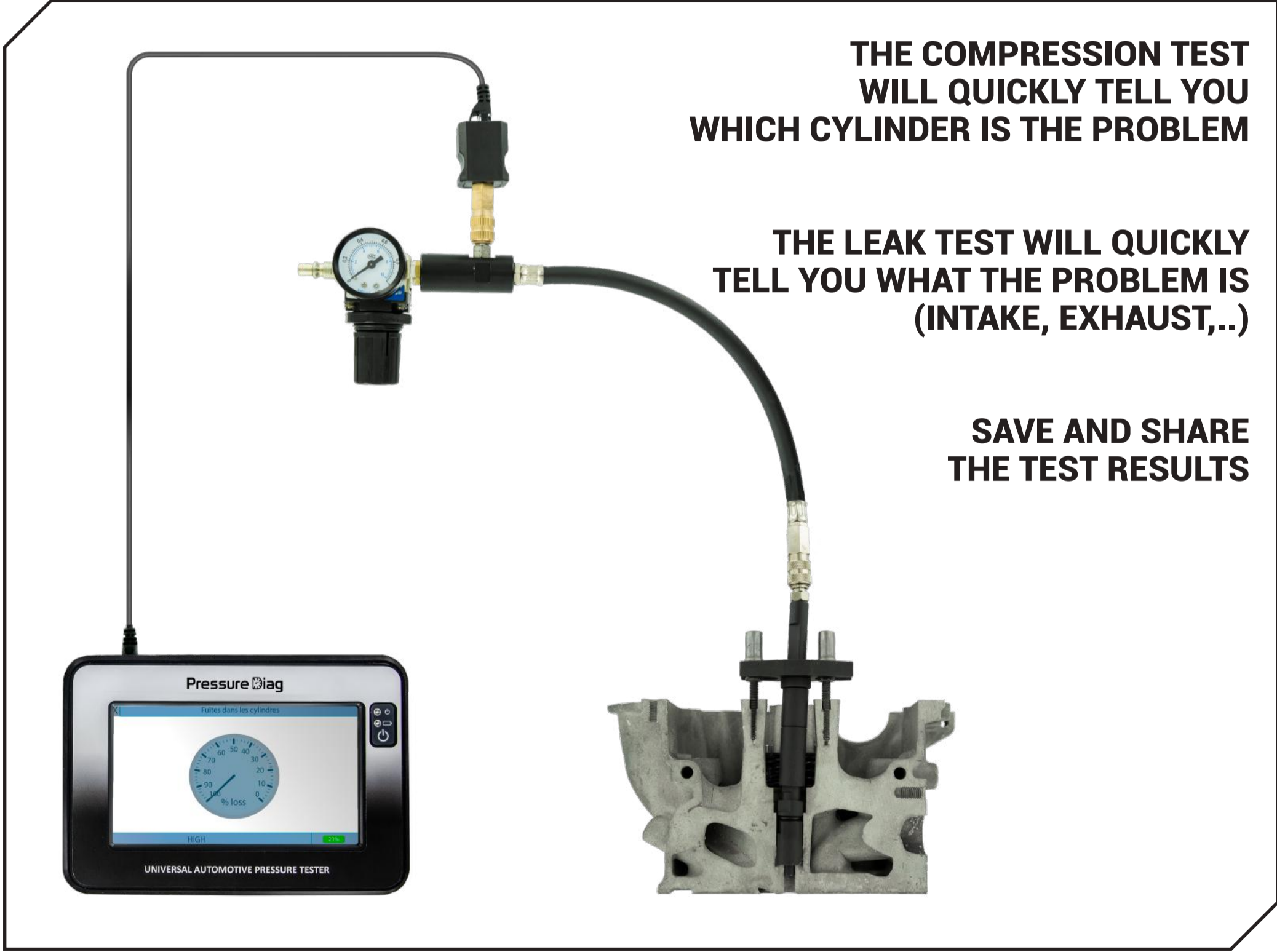

ENGINE & TURBO OIL PRESSURE ADAPTERS SET(15 PCS)

NEW

HU35033

- This kit allows, using the 0-300bars sensor included in the Pressure Diag kit, to test the engine & turbo oil pressure of most popular engines
- 10 x adapters to fit most of the oil pressure sensor
- 4 x adapters fit the most turbo banjo
- 1 x 90° quick connector



INCLUDING ADAPTERS TO MEASURE THE **OIL PRESSURE** DIRECTLY ON THE **TURBO**

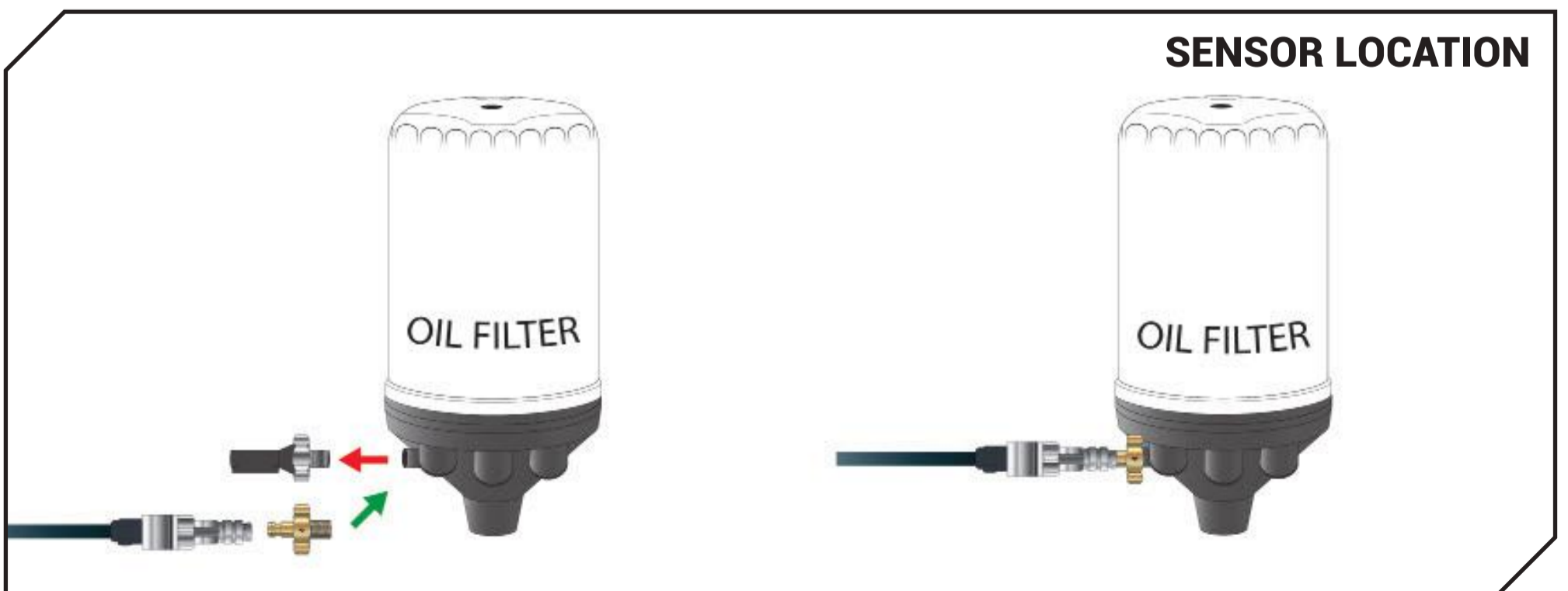
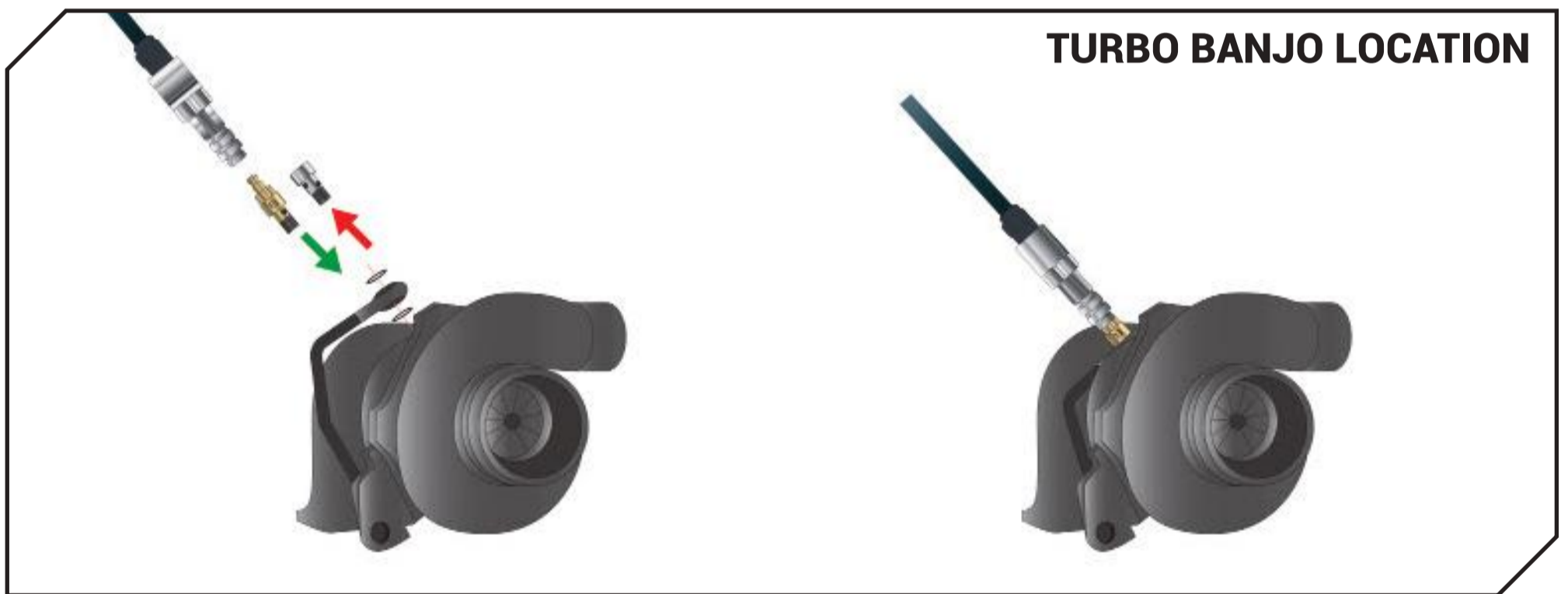

ADAPTOR MITYVAC 2.0

HU35025-12

USE THE **MITYVAC PUMP** IN COMBINATION WITH THE **PRESSURE DIAG**

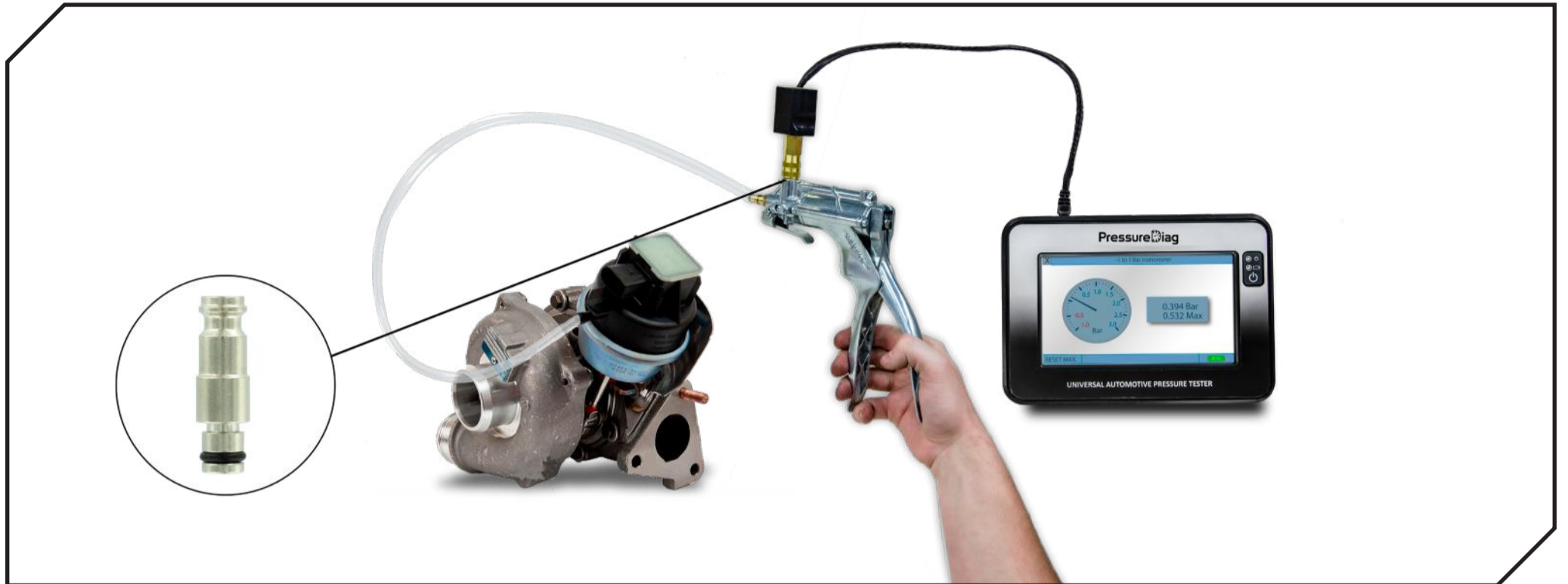

MITYVAC METAL HANDPUMP KIT

MI8550

The only hand pump that can produce and measure vacuum OR pressure with equal performance and precision
Ergonomically designed handle

GENERATE A **VACUUM AND PRESSURE**

- Single-hand vacuum/pressure release action allows multiple tests without disconnecting
- Protective rubber boot surrounds high quality gauge
- Gauge is angled and swivels 360° for improved visibility
- Large reservoir design (480 ml) with quick connector
- Great performance : -980 mBar to more than 4 Bar
- Common applications : Emission control systems (EGR, RCV, BPV) testing, Turbocharger wastegate testing, vacuum and pressure brake and hydraulic, clutch bleeding, ignition system diagnostics, fluid transfer/evacuation, automatic transmission service



SMOKE MACHINE

HU12020

Specifications:

- Rated voltage: DC12V
- Rated power: 100W
- Smoke output: 20-30L/MIN

Working pressure: 1,3 Bar Delivery (0-18PSI)

- Smoke Leak Detector One Set
- Valve core
- Smoke pipe
- Power cord
- Universal inflatable adapter
- One large, medium and small taper joint
- 250ML bottle of smoke oil
- Hook



NEW



OEM-APPROVED VAPOR PRODUCING FLUID

HU12011-13

- Our OEM-Approved Vapor Producing Fluid is designed specifically for automotive smoke machines
- One 8 fl oz (29.6 ml) bottle can service over 1000 vehicles
- Made with Mineral Oil USP or NF, white medicinal or Food Grade Type H1



Scope +

HU31025

- Solely designed for automotive electrical circuits' trouble shooting !
- Easy and simple to use; no extensive electrical knowledge needed
- Fully protected. Will not cause damage even if accidentally using OHM measurement to measure Volts
- Ideal to locate parasitic draw

Measures :

- Amps measurement (0 to 30 Amp !!)
- Voltage (max. 50VDC)
- Cranking volts with auto hold function
- Resistance [Ohms] (from 0.0 Ω up to 1.0 M Ω)
- Frequency with peak to peak volts (up to 20KHz)
- Duty cycle (%)

In addition, it performs:

- Continuity test
- Diode/ LED test

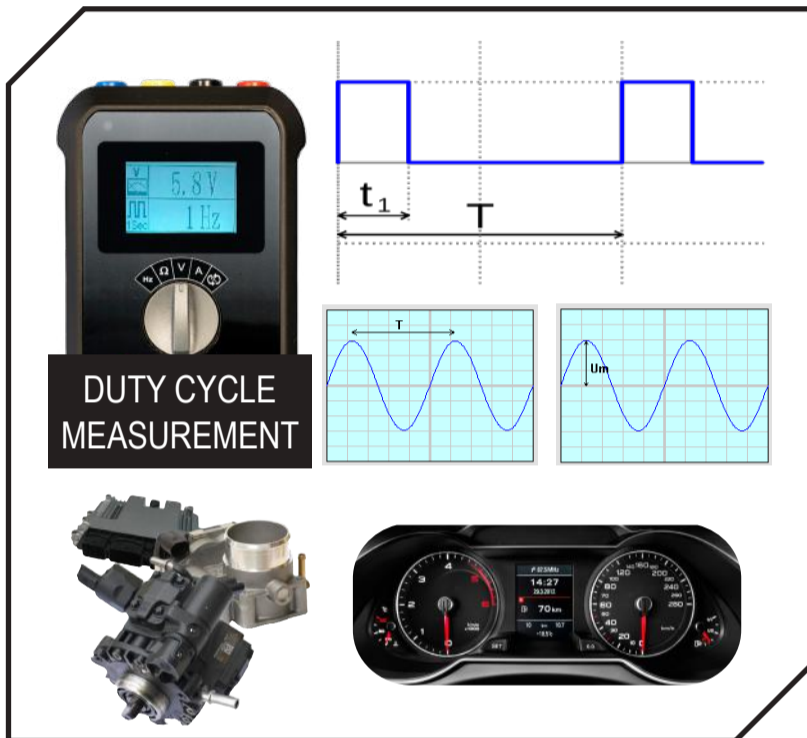

EASY TO USE - AUTORANGE
IDEAL TO LOCATE PARASITIC DRAW

DIAGNOSTIC TEST LEAD SET

HU31022

- Complete lead kit for Automotive diagnostics
- Content almost all connection leads for connecting to sensors, valves, connectors, injectors ...
- All leads are arranged properly in pairs "Male & Female" and by terminal sizes
- Includes ATC adapter Mini and Maxi fuses and ATC Current loop to be used with an Amp Clamp
- Includes Piercing Extra Sharp Probes. This innovative design gives enough retention force to pierce through the wire's insulator
- Airbags simulator : Used to confirm SRS Airbag power input by connecting it first to check for any short circuit before installing new SRS
- Replaceable resistors ! 3 ohms, 2 ohms, 2.2 ohms and 2.7 ohms
- LED Stroboscope: For checking series of terminals for correct wiring. Also for pulse or signal comparison between injectors. LED turns red for reverse polarity. LED turns green for correct polarity
- Also includes general purpose components, alligator clips, Banana plug to be used with multimeters, 3 way extension plugs and detachable test probes

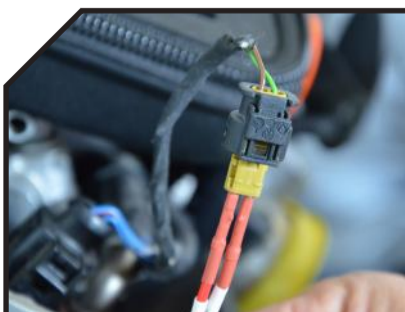

ULTRA THIN LEAD FOR MULTIPINS CONNECTOR.

SENSOR SIMULATOR

HU31035

- It will help you in your diagnostic when scan tool diagnosis ends. Sensors, injector actuators will inform the scan tools that something is wrong but Sensor simulator will allow the technician to know if the faulty operation is a faulty sensor, a defect in the wiring or a problem in the computer itself
- The product is mainly used for wiring tests. This is because the device can simulate the signal and compare to the scan tool
- You can simulate most sensors, injectors or actuators as ABS sensor, lambda sensor, EGR sensor, CKP sensor, knock sensor and map sensor
- Eliminates need to replace non-defective sensors, by the time you have changed a couple of un-needed sensors the device has paid for itself
- Now also able to generate up to 4amps to activate flaps, actuators, valves, small DC motors, injectors, light bulbs, ...

Simulator functions :

1. Simulated resistance
2. Simulated voltage
3. Simulated sine wave
4. Simulated square wave
5. Simulated temperature coefficient sensors
6. Simulated throttle & pedal sensor sequences
7. Oxygen sensor : testing mode : and simulated mode



SIMULATE AND ACTUATE THE OUTPUT SIGNAL FROM AUTOMOTIVE SENSORS: FREQUENCY, VOLTAGE AND TEST SEQUENCES

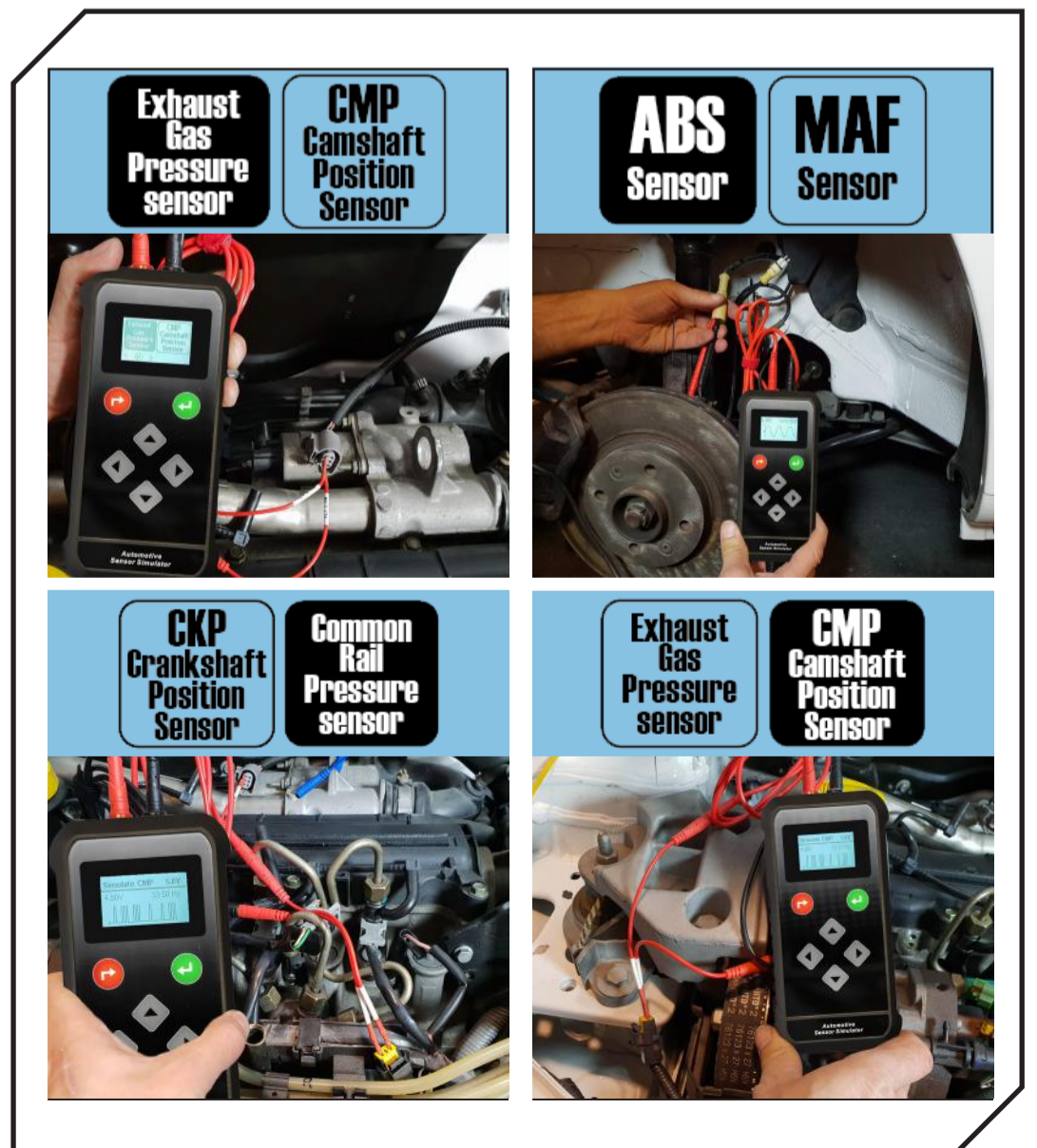

WIRELESS ELECTRONIC STETHOSCOPE

STE97216

Quickly pinpoints source and location of noise during a road test, even on long vehicles such as trucks, buses...

Clamps can be fixed onto springs, shocks, body mounts, brakes, engine blocks, etc.

INCLUDES:

- A receiver with 4 channels
- 4 transmitters
- 4 sensor clamps



**LOCALISE NOISE
DURING A ROAD TEST
AND RECORD IT**

RECORDING CABLE

HU97001

- Using this special cable, record the noise of the stethoscope on any smartphone while listening live
- Works on android and iOS (Iphone)
- Reasons to record the noise : warranty proof, traceability, customer proof of repair etc.

**SHARE EASILY
YOUR RECORDINGS !**

NEW



**THANKS TO THIS SPECIAL CABLE
MAKE ANY STETHOSCOPE'S
SOUND RECORDABLE !**

E85 ETHANOL TESTER

HU35034

NEW

Due to the huge price difference between E85 and regular petrol, vehicles owners tend to fill E85 in non-adapted vehicles which leads to:

- Engine misfires
- Knocking
- Degraded mode
- Engine dash light
- Unable to start

The default feedback (OBD2) does not refer to the real failure of the vehicle and leads to changing expensive parts that are not necessarily faulty

- This handheld tester is delivered with OEM type quick connection adapters
- No need to extract fuel from the tank. No risk of fire
- Simply connect the tester using the right adapter and let the engine idle for a few seconds. Tester will give you the accurate percentage of Ethanol in the fuel
- Powered by the vehicle's 12v battery

**QUICKLY & SAFELY CHECK
THE ETHANOL % IN THE FUEL**

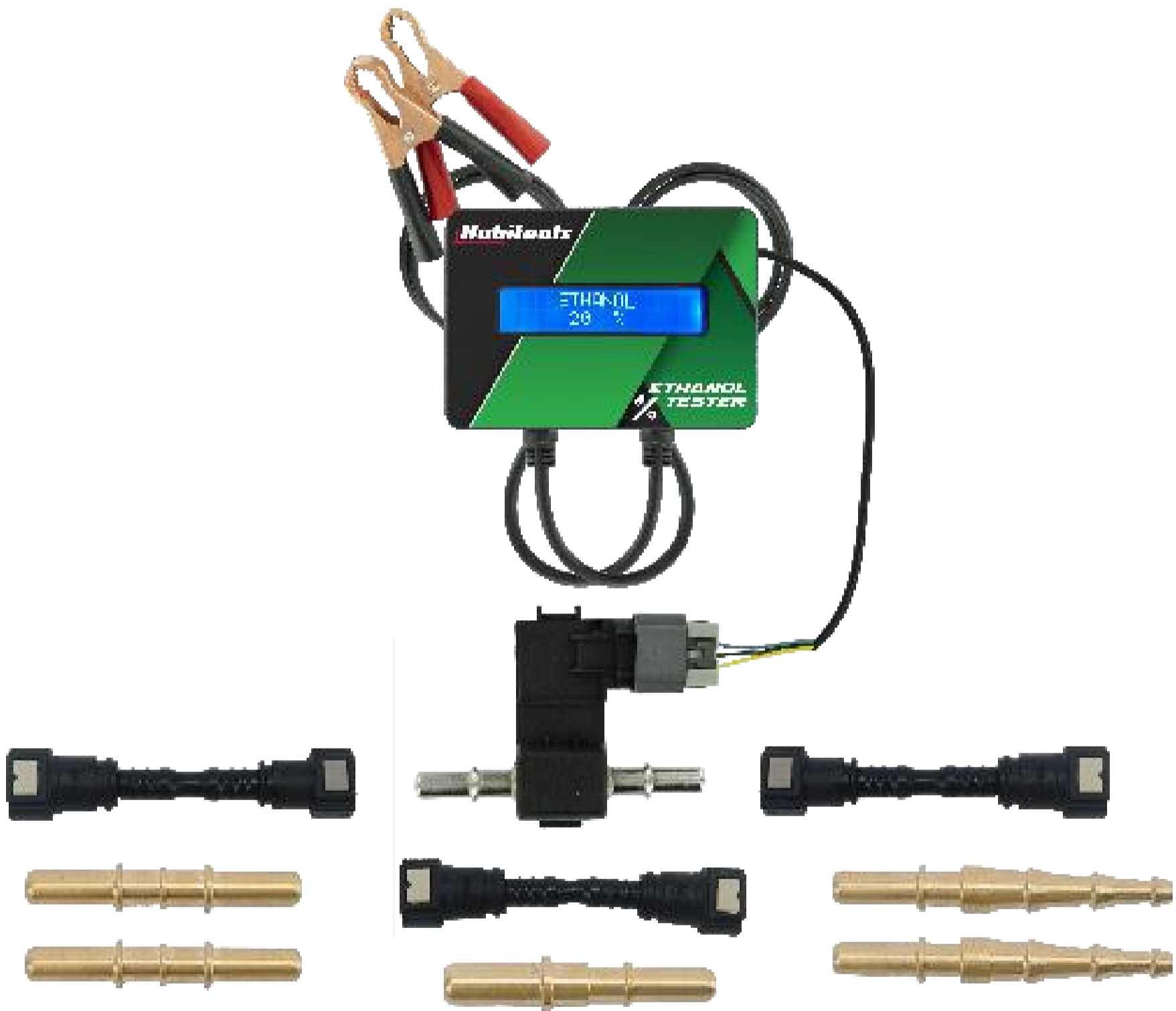

VIBROSHOCK

HU41045

- Vibroshock is the ideal tool to untighten frozen screws, nuts or glow plugs without any damage
- To be used with an Air-hammer (not included)
- Applications : brake screws, exhaust screws, rounded lugs, glow plugs, clamp-on injectors...

Kit includes:

- Vibro-shaft with 3/8" square drive
- Articulated wrench
- 7 impact sockets with internal edge



UNIVERSAL GLOW PLUG TIPS PULLER M8, M9 & M10

HU41050

- Easy to use in hard-to-reach places
- Enables broken glow plug tips stuck in the cylinder head to be easily removed
- The kit comprises 4 easily identifiable guides
- The tap, drill bit and extractor holders reproduce the shape of original glow plug for perfect centering and avoid any damage in the cylinder head
- Self-centering industrial taps
- The size of the drill bits and the shoulder of their holder prevents any risk of drilling or tapping too far into the cylinder head without prior measurement
- In the event of the tips being flared in the cylinder head, the kit has an ejector that enables the tip to be pushed back into the cylinder before retrieving it with the appropriate magnet included in the kit
- Easy 4 step operation



REMOVES **BROKEN TIPS**



SELF-CENTERING TAP



STOP BLOCK
-> NO MEASURING NEEDED



PUNCH FOR FLARED TIPS

- 1 = M8 x 100
- 2 = M9 x 100
- 3 = M10 x 100
- 4 = M10 x 125

UNIVERSAL DIESEL GLOW PLUG PULLER M8, M10X100, M10X125

HU41051

- Minimal space needed for use : ideal when glow plug compartment is not easily reachable
- Enables glow plugs broken in the top of the cylinder head to be easily removed without any damage
- Usable in narrow engine bay and engine with glow plugs on the firewall's side
- High quality material for professional use !
- Unique design of electrode puller to tear out the longest part of the electrode as possible
- Easy to use :
 - The kit includes 1 electrode puller and 1 electrode reinforced drill with 2 guides
 - It includes 2 special centered mills with one mill support that prevent any damage to the head
 - A tap and a slide-hammer extractor to pull out the broken glow plug
 - 3 refreshing taps : M8 , M10x100 and M10x125 with Hex Drive to be used with any ratchet and self-centering feature



**SPECIAL
CENTERED MILLS**

MINIMAL SPACE NEEDED FOR USE

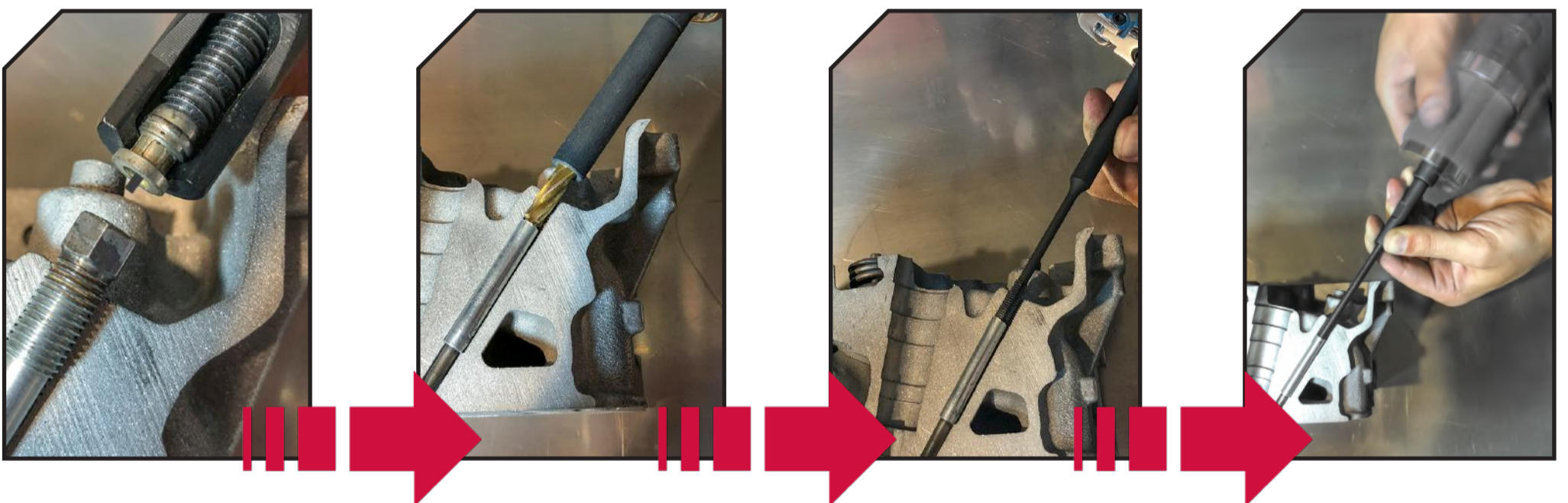

GLOW PLUG THREAD REPAIR KIT M8, M9, M10X100, M10X125

HU41058

- This kit is designed to repair the engine glow plug threads M8x100, M9x100, M10x100 & M10x125 quickly, professionally and permanently. It fits perfectly modern vehicles with very little space and access to glow plugs
- Each tool (reamers & Taps) is self-guided !
- No need for glue or thread seal
- Ream ! Tap ! And replace !

The kit includes :

- 2 cylinder head reamers: 9mm and 11mm
- 4 special taps 4 mounting tools
- 4 spare thread repair inserts of each size M8 x 100 (short & long) ; M9 x 100; M10 x 100; M10 x 125

Spare Thread inserts available separately (see below)



REAM



TAP



REPLACE WITH INSERT

THE ONLY PROFESSIONAL AND UNIVERSAL KIT FOR GLOWPLUG THREAD REPAIR ON THE MARKET !



EACH TOOL IS SELF-GUIDED

EACH TOOL IS HEX-DRIVEN

UNIVERSAL INJECTOR EXTRACTOR

HU41055

- Single universal kit that enables all types of moderately frozen injectors to be removed without removing the electrical part, even on the latest vehicles
- For Denso, Siemens, Bosch and Delphi common rail or piezo injectors from 1999 till today
- Extraction of the injector by the fuel inlet port
- The kit also includes two couplings (M12 and M14) in the event that the original coupling cannot be removed
- Two ways of extracting the injector.
By rotating (handle)
By rotating AND axial extraction (mass to inertia) in the most difficult cases

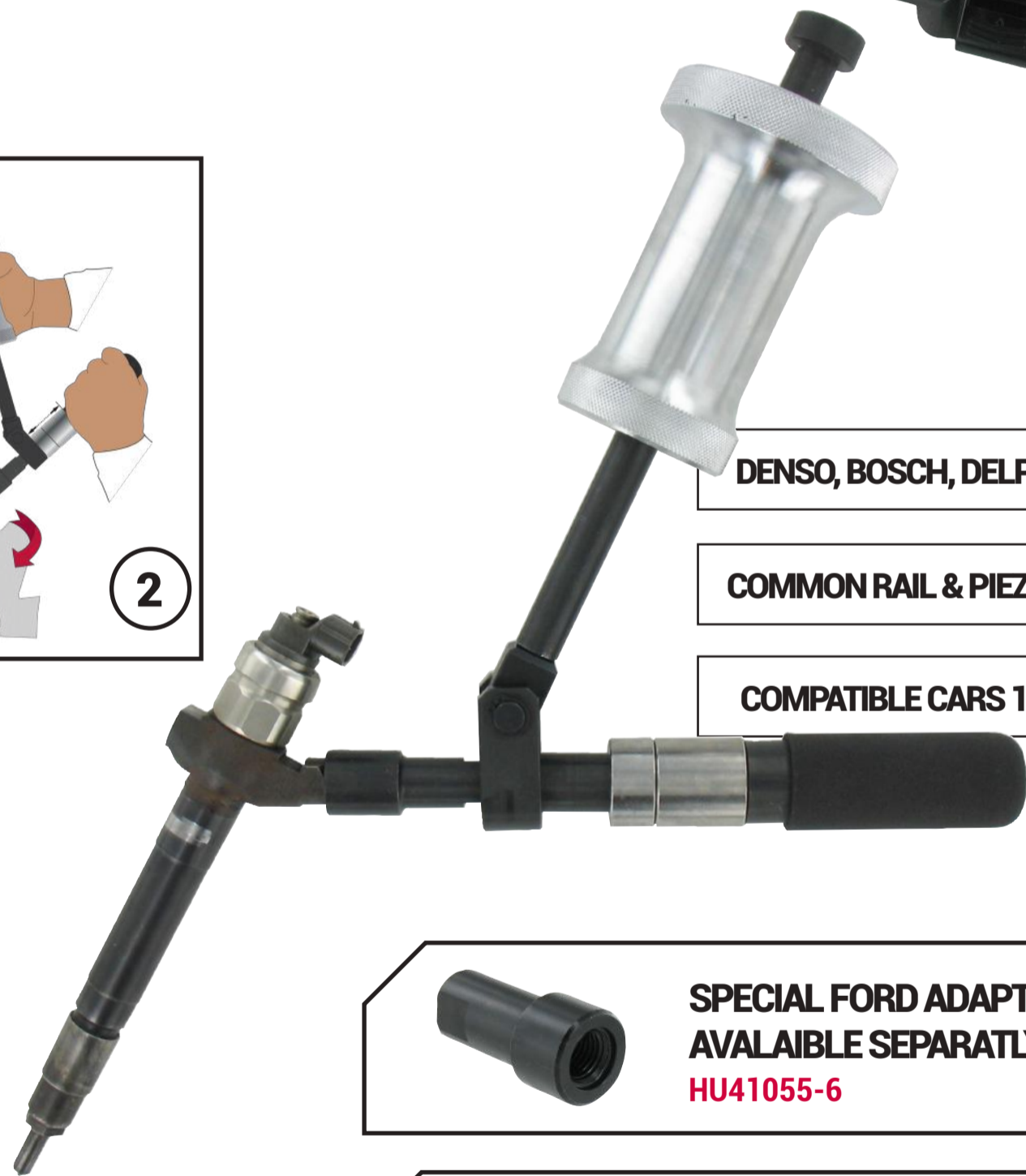
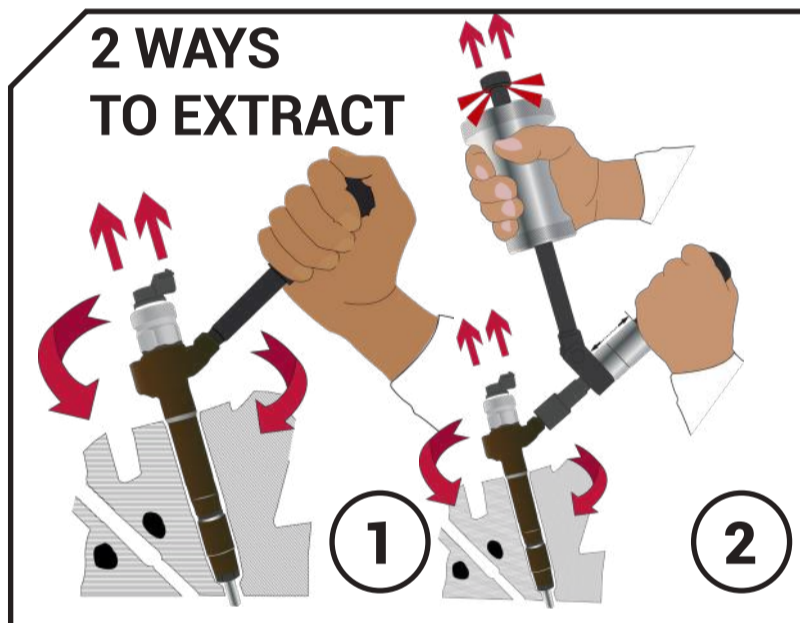

DENSO, BOSCH, DELPHI, SIEMENS

COMMON RAIL & PIEZO INJECTORS

COMPATIBLE CARS 1999 > TODAY

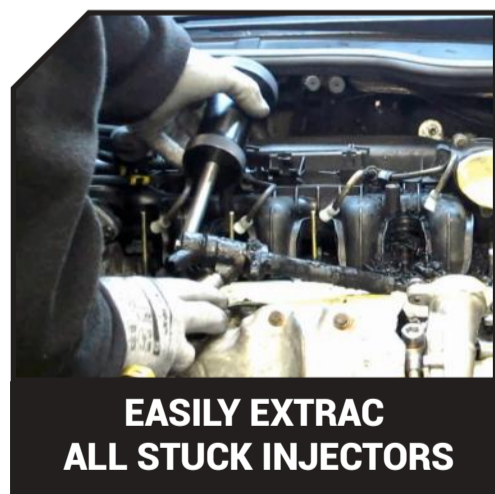

DIESEL INJECTOR SEAL EXTRACTOR

HU41010

- Removal of diesel injector seal that is completely clogged and stuck in the housing
- Slide hammer of 1000 grams to remove the most difficult seals
- Integrated hexagonal socket in the slide hammer to screw the extractor into the seal (left-handed thread)
- Conical remover with double thread entry
- Provided with two removers: One for light vehicles (LV) and the other for light utility vehicles (LUV)
- No risk of parts dropping into the cylinder
- No adjustment
- Very easy to use
- Very quick
- High quality equipment for professional use

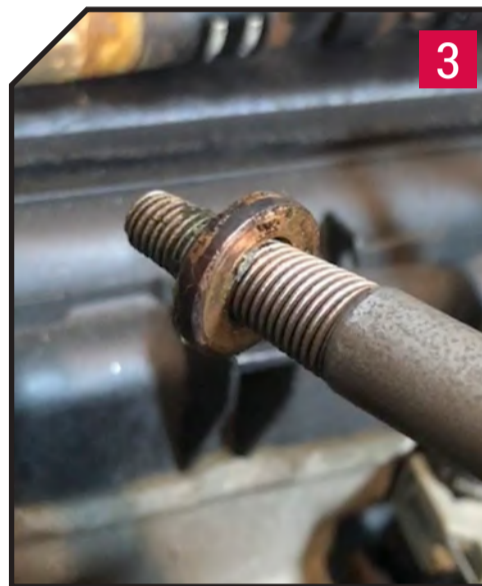
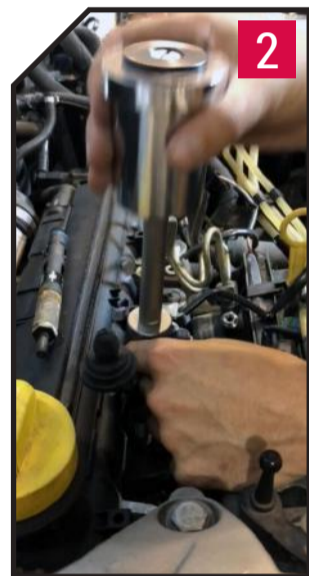
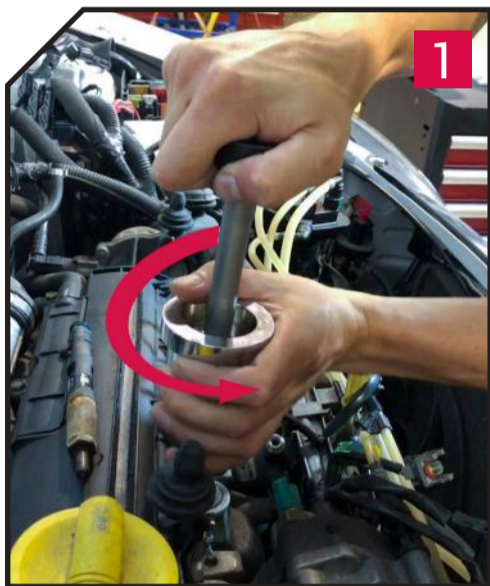

UNIVERSAL INJECTOR SEAT CLEANING SET

HU41039

Kit includes :

- 2 metal brushes Ø 20mm and 25mm for injector hole cleaning
 - 2 front brushes for injector seat cleaning
 - 1 front brush extension
 - 2 seal plugs to close the injector hole while cleaning
 - 1 seal plug holder to place and remove the plug
 - 1 sanding kit (paper and paper support)
- This set will allow the technician to make a perfect job before placing the new injector !
 - Cleaning the injectors holes after the extraction is extremely important

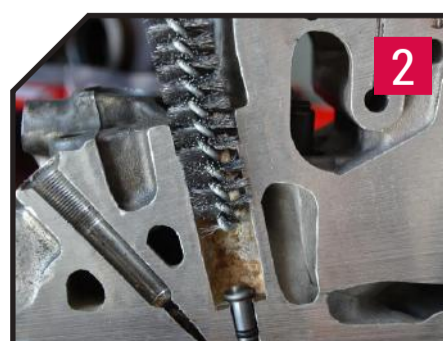

CLEAN FUEL EXTRACTOR

HU46005

- To retrieve fuel following a filling error (gasoline instead of diesel, etc.), remove a submerged fuel pump, change or check the fuel gauge, rinse the fuel tank, during body work, etc.
- Operates off workshop compressed air (no risk of sparks)
- Mobile 45-litre tank (on wheels)
- Cleanly draws up or pushes out fuel thanks to a venturi system
- 2 anti-static ground cables, overflow line and 3 fuel probes
- Emptying via the tank filler neck or fuel lines
- Made of stainless steel
- Meets the ATEX standards

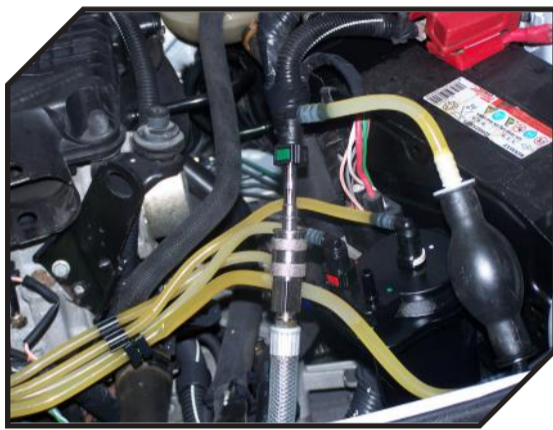

QUICKFLOW DRILL PUMP TRANSMISSION KIT

AB71197

- The QuickFlow pump is a high efficiency gear type pump
- It is fitted with a folding engagement bracket to allow the pump to be driven by a 3/8" air ratchet
- Using the included universal adaptor allows the pump to be driven by most cordless drills

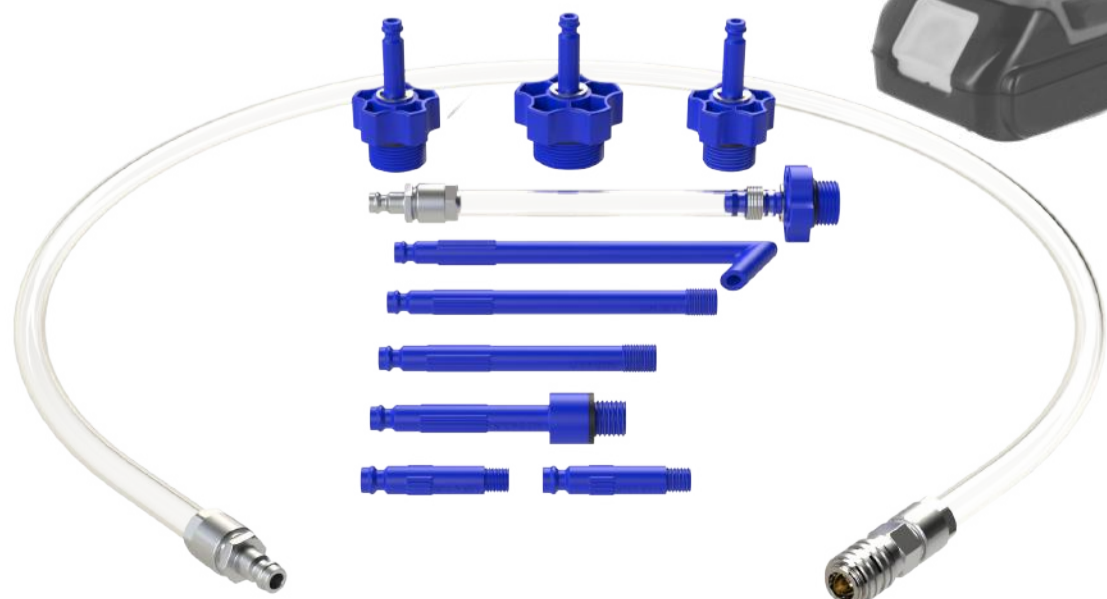

LUGDRILLER: LOCKING LUG NUT REMOVAL KIT

HU42025

- The Lugdriller™ is the ultimate tool to remove the most difficult locking lug nuts in the quickest and safest way
- Over the years the locking lug nuts have been dramatically improved. Their design is more and more complex and the material itself harder and harder. Problems with damaged lug nuts or keys are wellknown in the tire repair shops business
- Professional kit : made of solid material that can work on the hardest lugs
- Removes the most difficult locking lug nuts
- Very easy and quick to use : +/- 8 minutes per wheel only!

UNIVERSAL :

- Works on all types of sockets from any brand
- Also works on all modern cars with oddly shaped lugs
- Also works on damaged lugs



THE ONLY UNIVERSAL KIT

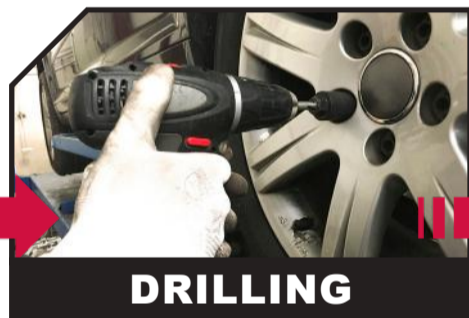

SILENT TYRE VALVE DEFLATOR

HU43012

- Deflating operation by unscrewing the tire valves (Car, Truck, bus) exposes technicians to noises that can lead to deafness
- The Silent Tire Deflator patented by INRS allow to reduce noises emissions during tire deflation

Features:

- The Silent tire Deflator is equipped with a filter cartridge that reduce the noise from 115db to 85db!
- His retractable screwdriver allow the technician to dismount easily and with one hand only the tire valve
- Furthermore the use of this avoid the ejection of the valve during its dismounting



85 DB Max



STRUT LIFTER

HU43025

- Supports the strut on the vehicle: 500Kg
- To be mounted on 30mm Hydraulic transmission
- POM (polyoxymethylene) clamping jaws to avoid damage to the strut. 3 Sizes of Jaws (Light vehicle , Light commercial vehicle , rear shock absorbers)
- Depth and tilt adjustment

Ideal for the following operations :

- Removal and installation of struts
- Removal and installation of drive shaft
- Removal and installation of arms and Hub ball joint separation
- 100% safe Work
- Operator has both hands free to work safely.

No risk of damage to parts as :

- Sensors
- Wiring harness
- Plastic protection, Body

NEW

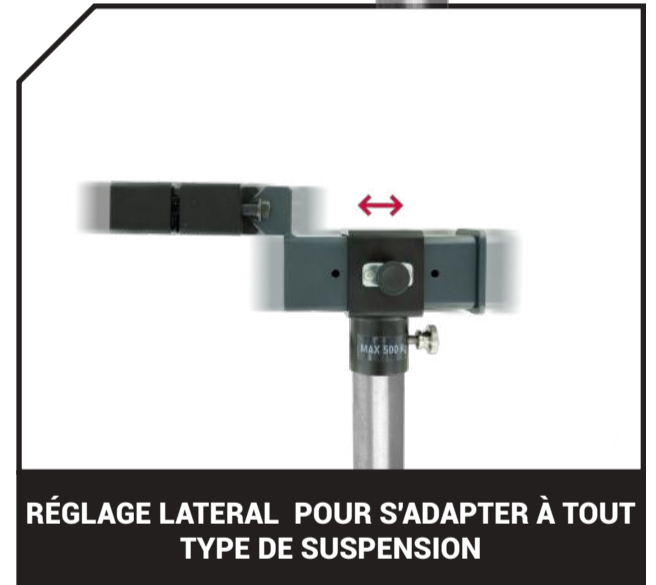

**WORKS ON ELECTRIC VEHICLES
TESLA, ZOE, LEAF, HYUNDAI, KIA ETC..**



**IDEAL FOR MODERN VEHICLES WITH
DOUBLE WISHBONE SUSPENSION**

PRESSURE BRAKE BLEEDER KIT WITH UNIVERSAL ADAPTOR

AB71160

- Extremely safe and strong construction
- Easy to use
- Works on standard garage compressed air
- Creates a pressure of 1,5bar
- Large (2.5 L), easy-access bladder for quick change of different brake fluids
- Extra-long braided high-pressure quick-connect hose, provides the ability to reach a vehicle while elevated on a lift
- delivered with Eu standard threaded master cylinder cap adaptor
- Custom made pre-set pressure regulator. eliminates any risk of operator accidentally over pressurizing system
- Custom Pressure Relief Valve: pre-set to max 1,7bar relief pressure;

NEW

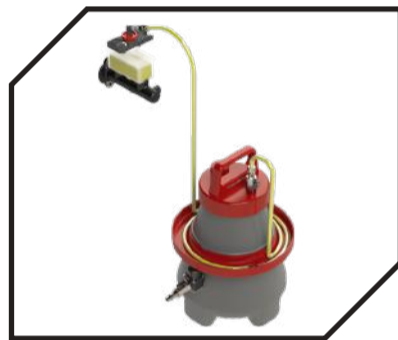

EASY ACCESS BLADDER

PRESET PRESSURE

UNIVERSAL BRAKE BLEEDING CAP ADAPTER

AB71161

- To be used with HU11006 or HU11030
- 5 interchangeable sealing cones from diameter 20 mm to diameter 60 mm
- Works on bayonet or threaded master cylinder fitting
- Very Compact design with 75° quick connector
- Height and width adjustment for an universal use

NEW



UNIVERSAL SOLUTION

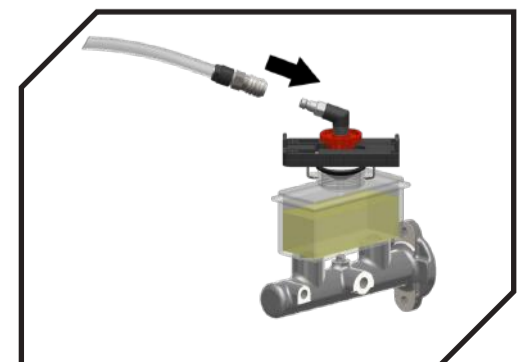
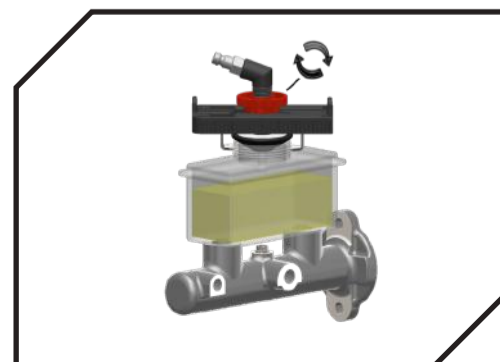
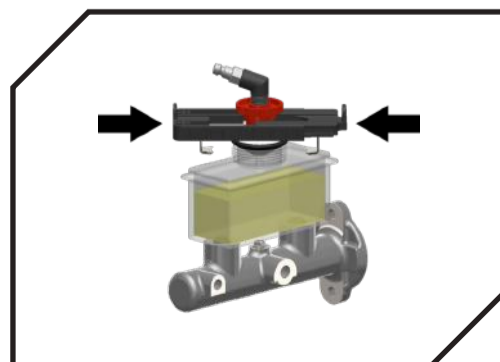
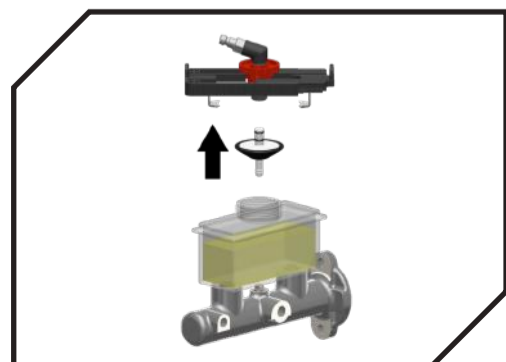

ELECTRONIC BRAKE PRO BLEEDER

NEW

Professional brake bleeder available in 2 configurations, 3 possible power supply modes, fully electronically managed and designed with one goal : Reliability and robustness.

- LCD color screen and user friendly 4 button touch panel
- Bleeding with adjustment from vacuum 0,5bar to pressure 4,5bar
- Automatic leveling of the master cylinder's reservoir
- 5 languages
- Psi and bar
- Automatic stop when the new DOT drum/Can is empty
- Many safety functions such as automatic stop when the bleeder detects an abnormal pressure
- Works for Brake and clutch bleeding
- Pulsating pressure
- Interchangeable Drum/Can and Flushing mode for different DOT use.
- Flexible Length : 5 meters.
- Includes EU standard master cylinder cap adaptor
- Includes old fluid retrieving bottle with nip adapter and chain

What makes it different ?

- Uses a Eu made high quality gear pump
- Clever management of the hydraulic system thanks to the specific software, making it highly reliable
- One-piece hydraulic system without return line
- Robust design with quality material to withstand tough garage environment
- Versatile (configuration – power supply – capacity-...)

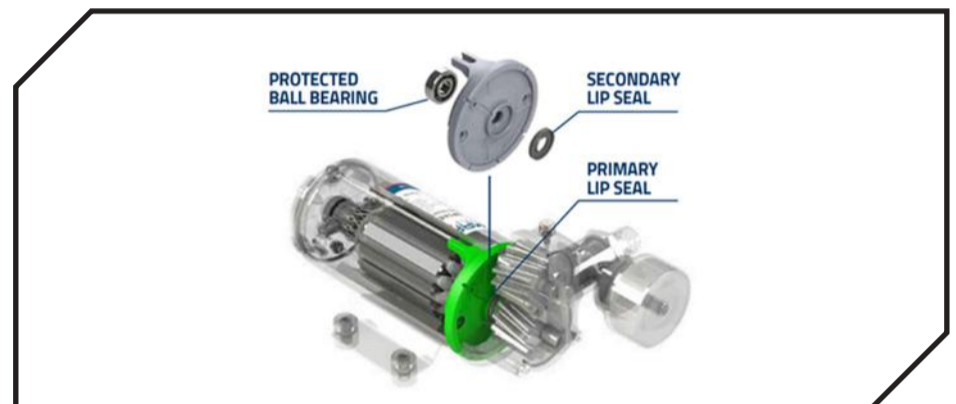

HUBITOLS REINVENTS THE BRAKE BLEEDER

Configurations:
 HU11030: Portable version up to 20 liters
 HU11035: On trolley version up to 60 liters
 Also available :
 HU11036: Trolley only
 (To upgrade the portable version to On trolley version)

60 Liters

20 Liters



HU11030



HU11035

VIDEOSCOPE 4.9mm WITH SWITCH PROBE

HU23085

HIGHEST QUALITY ON THE MARKET :

- Videoscope : shock resistant , glass screen (no plastic, no scratch)
- Probes : IP67, all fluid resistant (water, coolant, oil, break fluid, fuel, transmission...), unique design with shock resistant anti reflection lens

UNIQUE DESIGN :

- Ergonomic probe connection (probe goes downwards)
- Large 3,5" screen
- Small and handy with a variety of functions
- High resolution : 640x480
- Zoom : digital zoom 3x 5x
- Mirroring : complete mirroring and rotating
- Photos and videos
- 16Gb Sd card included
- Light adjustment
- 28 languages available
- Works with AA batteries or external power supply
- Probe only : HU23058

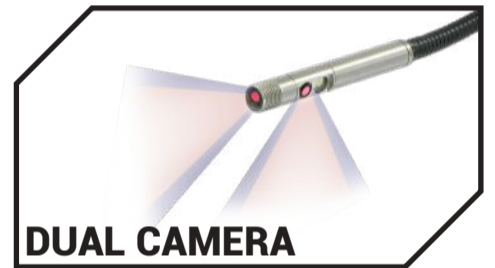

VIDEOSCOPE WITH 4,5mm 1 WAY ARTICULATION PROBE

HU23075



- Diameter is 4.5mm with 1 meter
- Articulation angle is over 170 degree : no need for mirror adapter for side view
- Light boost in dark area
- 90° image rotations
- The 13mm shorter distal tip of camera head allows to articulate in smaller spaces
- Automotive applications : ideal for common rail engines, air condition system, exhaust system, diesel injection ports, glow plug ports, power window ports, lock of trunk

VIDEOSCOPE WITH 4,5mm 2 WAY ARTICULATION PROBE

HU23079



- IP67, water and scratch resistant 6mm diameter, 1m long with 360° view articulated tip (2 ways / up 155° / down 155°)
- Boost feature : using under the low lux environment, the brightness and contrast of the image will be optimized.
- Particle-free feature : the light button coupled with the mirror erases the spots that often trouble the vision when using a mirror (improves particle effect) 3 forward LED for normal use and 2 side
- LED for use with mirror (included in the kit)
- 360° screen rotation feature (90° phases)

VIDEOSCOPE DUAL LENS 4.9MM

HU23150

- High quality compact videoscope
- Works on rechargeable Lithium battery
- Petrol, diesel, oil & waterproof probe with dual HD camera front and side view
- With a 5-inch HD IPS Color Screen that features scratch-resistant tempered glass and maintains an excellent vision even in strong sunlight
- Powerful ring LED light source on both lens
- Efficient Flood light on the back of the main screen system to help during work
- Takes pictures, record movies with sound for vocal annotations (Ideal for warranty proof)
- Built in Microphone and speakers
- 32GB memory card (included)
- IP67
- Includes a screen holder bracket
- Best value for money!

NEW

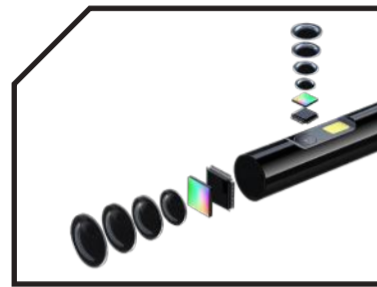

**SCRATCH-RESISTANT
5-inch SCREEN**



**3500mAh
LITHIUM BATTERY**



**SPEAKER & MIC
VOCAL ANNOTATION**



WIFI SWITCH PROBE ENDOSCOPE

HU23135

Fast Wi-Fi connection to use with smartphones
Professional device with excellent price for value
Easy to share pictures and videos through all smartphones applications (Messenger, WhatsApp, Email...)
Space saving : allows maximum freedom of movement

- 4,9mm dual camera probe
- Dual Led lights
- 105cm semi hard probe
- Perfect resolution for smartphone
- Wi-Fi box with magnetic body for ease of use
- Usable for 2 hours with one battery charge
- USB to Micro USB charging cable
- Magnet for smartphone (stick it or slip it between phone and cover)
- Support Android and IOS

Smartphone app functions :

Take pictures
Make videos
Adjust light
Switch from front view to side view



FREE APP AVAILABLE

WI-FI BORESCOPE

HU23136

- One way (180°) articulated
- 4,5mm Diameter probe
- Wi-Fi connection to use with a phone or a tablet
- Support Android and iOS
- Share pictures and videos through any apps (email/whatsApp/ messenger...)

Smartphone app functions :

- Take pictures
- Make videos
- Adjust light



FREE APP AVAILABLE

BLUETOOTH BATTERY TESTER + LIVE MONITORING

HU34045

Ideal For Smart Alternator Test
(Smart Battery Charging System)

4 Modes in 1 Tester :

- LIVE MONITORING DYNAMIC TEST (0-36v)
- BSM Battery System Management
- Smart Alternator



- Battery test
- Cranking test
- Charging system test

Test results easy traceability

- Scan the VIN & battery S/N
- Installation date of the battery
- Shop / garage info
- Customer info
- Share test results
- Optimal cloud data management



NEW



START & STOP BATTERY & ELECTRICAL SYSTEM ANALYZER WITH PRINTER

HU34012



Specially designed for Start & Stop systems

- Exclusive design by Hubitools
 - Tests 6V-12V batteries and 12V-24V volt charging & starting systems
 - Integrated printer
 - Digital screen
 - Operating range: 40 ~ 2000 CCA
 - Tests EFB, VRLA / GEL , AGM Flat Plate, AGM Spiral and Regular Liquid batteries in 2 seconds
 - Rating system: SAE (CCA) / DIN / EN / IEC and JIS
 - 6 languages available
- Two battery technologies : AGM and EFB

USB BATTERY & ELECTRICAL SYSTEM ANALYSER

HU34039



Print the test results directly with the integrated printer or export on a computer & share

- Tests all types of Start&Stop and standard batteries !
- Standard size paper rolls
- Possibility of inserting a CR2032 battery for date & time memory
- Handy design with large illuminated digital screen
- 3 functions : battery test, charging system test (alternator) and « in vehicle » test (Battery test and System test combination)
- Tests 12V batteries and 12V 24V charging systems : FLOODED, AGM FLAT PLATE, AGM SPIRAL, VRLA/GEL, EFB
- 6 Languages
- Operating range : 40 ~ 2000 CCA

120 AMP MULTI PURPOSE BATTERY CHARGER

HU34050

48V mild hybrid vehicle easily take a current over 80A once the power supply is connected!
HU34050 is the ideal ,robust and reliable high-power power supply charger

NEW

POWER SUPPLY MODE

- ECU re-Programming
- ADAS sensor Calibration
- Power critical Amp drawing operations
- 120 Amps

BATTERY CHARGING

- 12V Regular and Lithium (LiFePO4) batteries
- 100 Amps
- Quick battery diagnostics (identify failed batteries)
- 12V Lithium battery wake-up

SHOWROOM MODE

- Supply power to demo vehicles
- Perfect for digital cockpit and lighting demonstration
- 50 Amps
- Power cycle setting retention
- Setting lock

MEMORY SAVER

- Battery replacement
- ECU memory retention
- 30Amps

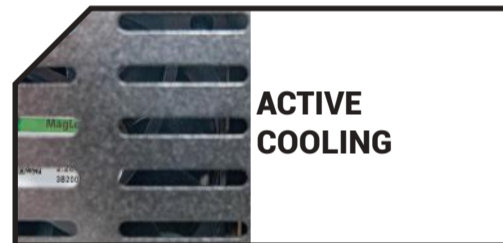
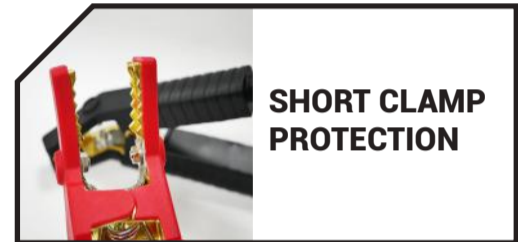

BATTERY CHARGER/ MAINTAINER/ POWER SUPPLY

1.5/10AMP

HU34027

All in one, 12V charging mode:

- SLI, AGM SPIRAL, AGM FLATPLATE, GEL, VRLA, CAL/CAL and START-STOP LEAD ACID
- Battery & LFP batteries
- Start & Stop EFB/AGM
- Lead-acid batteries and Lithium batteries
- Power supply mode (10AMP Flash Mode & Show Rooms)
- Save deeply discharged battery (Repair Mode as low as 2V)
- Protection : over-charging, spark free, reverse polarity, Temperature compensation, IP65

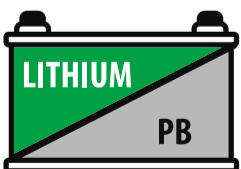

10 PCS ROUNDED FASTENER EXTRACTOR SET (8-17MM)

HU45115

- Extractor inserts for rounded nuts, Fit on wrenches and sockets (14mm and 19mm)
- Grips fastener even 85% rounded
- Also suitable for turning fasteners with no damage
- 8, 9, 10, 11, 12, 13, 14, 15, 16, 17mm
- Sits firmly in a wrench, without sliding through

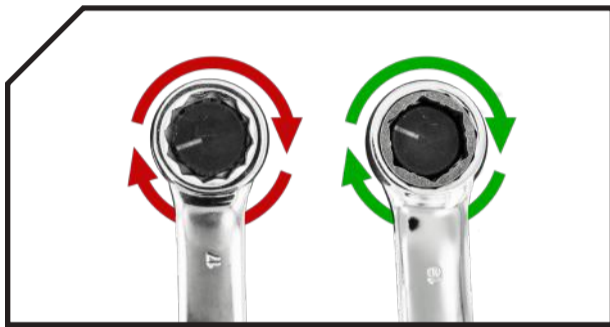
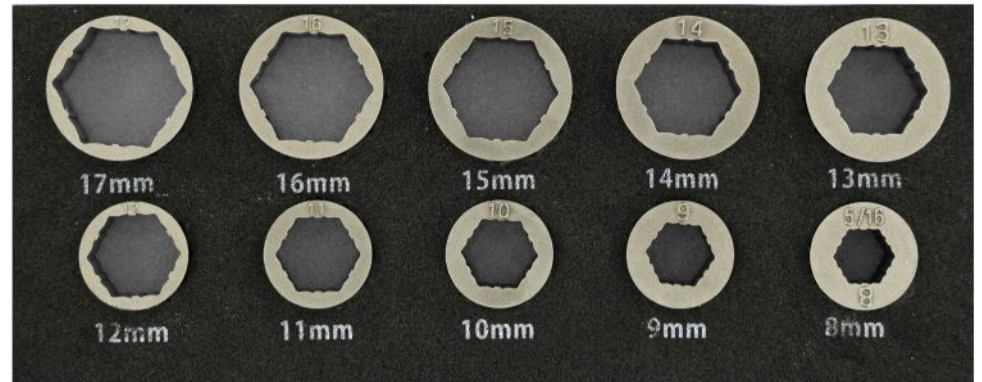

8 PCS HEX EXTRACTOR SET 1/4"DR 2, 2.5, 3, 4, 5, 6MM - 3/8" DR7,8MM

HU45116

- Ideal tools to takes out hex fasteners up to 85% rounded
- Can also be used on new fasteners
- 1/4" drive sizes: 2, 2.5, 3, 4, 5, 6mm
- 3/8" drive sizes: 7mm, 8mm

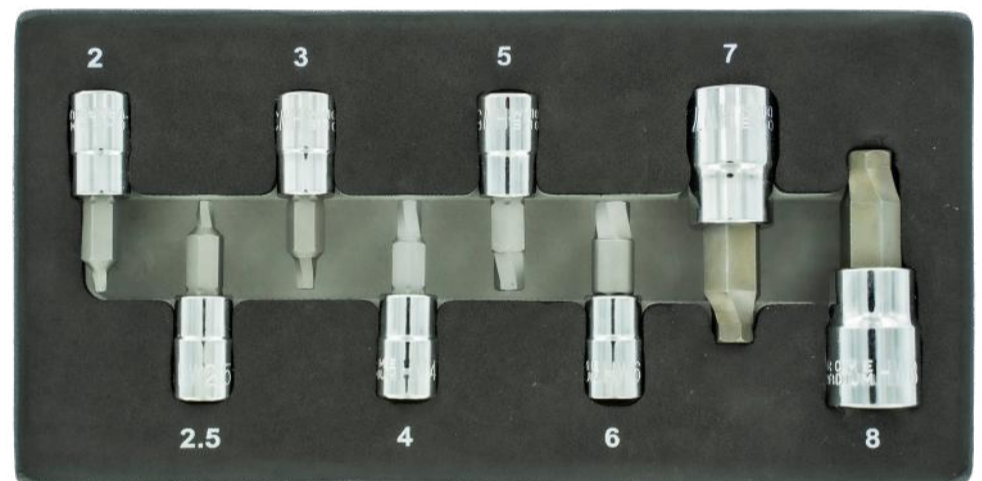

7 PCS TORX EXTRACTOR BIT SET 1/4"DR T10, T15, T20

HU45117

- Ideal tool for removing damaged TORX screws
- Can also be used to install new fasteners
- 1/4" drive sizes: T10, T15, T20, T25, T27, T30, T40

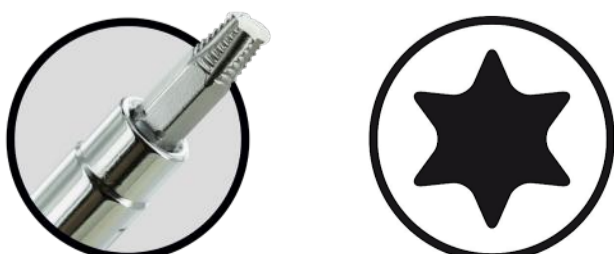
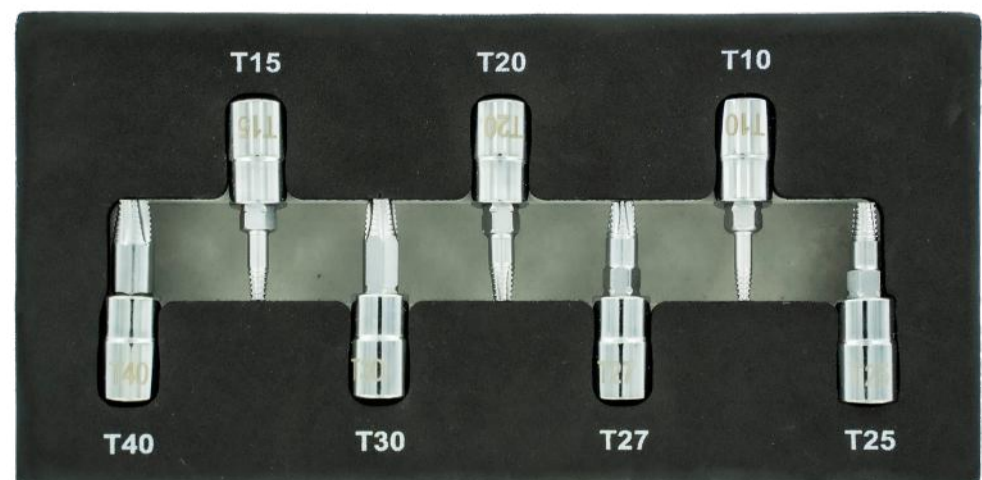

3 PCS RATCHETING WRENCH & RATCHETING DRIVER SET

HU45119

- Ultra compact to reach screws and nuts in very tight areas
- Ratchet style for an easy use
- Double articulation
- Size available : 8mm & 10mm, 11mm & 13mm, 1/4 drive & Bit Hex

IDEAL FOR SMALL SPACE

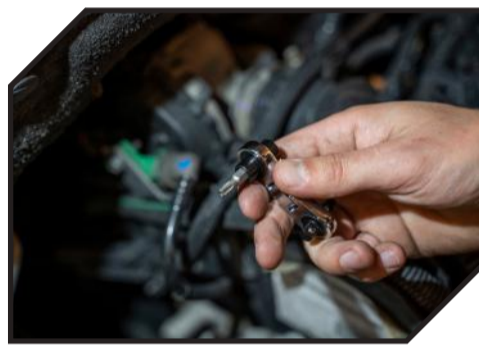

**UNIQUE FINGER WRENCH !
DOUBLE JOINT DESIGN !**

POCKET FLOODLIGHT WITH MAGNET 360°

HU21045

- Incredibly tough aluminum housing with sturdy handle which can rotate through 360°
- Virtually indestructible and one of the most durable flood-lights available
- Also fitted with a strong magnet, making it simple and easy to direct
- Up to 700 lumens of light
- Three light output settings : 100/350/700 lumens
- Features three LED battery level indicator
- Fitted with a high quality 3.7V 2.6Ah Li-ion battery
- Charges via a mini USB
- Battery : 3.7V 2.6Ah Li-ion
- Charging time : 4hr
- IP rating : IP65
- LED Qty : 7W COB LED
- Length : 95mm
- Lumen output : low : 100lm / mid : 350lm / high : 700lm
- Net weight : 255g
- Operating time : low : 10hr / mid:4hr / high : 2hr

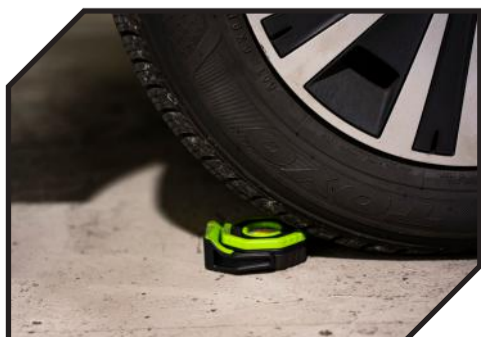

**ULTRA SOLID
ALUMINIUM DESIGN !**

**10 HOURS
WORKING TIME !**



COMPLETE SET FOR PLASTIC REPAIR

HU31031

- Everything you need for automotive plastic repair in one kit
- contents include: hot staple tip, plastic welding tip (max temp 500°C), plastic welding tip with welding rod guide, 12 plastic welding rods 150mm (ABS,PP,PE,PS), 3pc stainless steel wire mesh (50 x 100mm) & flat alloy steel staples (50pcs 0.8mm & 50pc 0.6mm)
- Complete plastic repair kit with rechargeable Li-ion battery
- No cable, very mobile with a high runtime
- Its heating speed makes work easier : no need to heat the iron 10-15 minutes before starting work. Here it heats up in 10-15 SECONDS to melt plastic and in one second for stapling

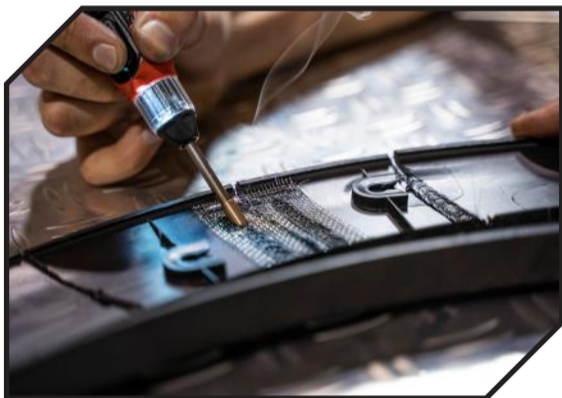

CORDLESS SOLDERING IRON

HU31030

- No 220V => no risk associated with the current.
- 30W: high power for a small device
- Unlike gas soldering irons, this does not involve any flame. Fire is not permitted in garages for obvious safety reasons
- No adjustment as with gas irons
- No ordering and shipping of gas .Logistically speaking shipping gas is problematic. (e.g. by plane)
- No cable. Very mobile with a high runtime
- Precision tip for fine solders (connectors, etc.)
- Universal tip for soldering cables (e.g: cabling a trailer hitch)
- Tip for heat-shrink sheaths: Does not come in contact with the sheath so it doesn't melt it
- Its heating speed makes work easier. No need to heat the iron 10-15 minutes before starting work. Here it heats up in 10-15 SECONDS
- Case remains cold throughout the operation

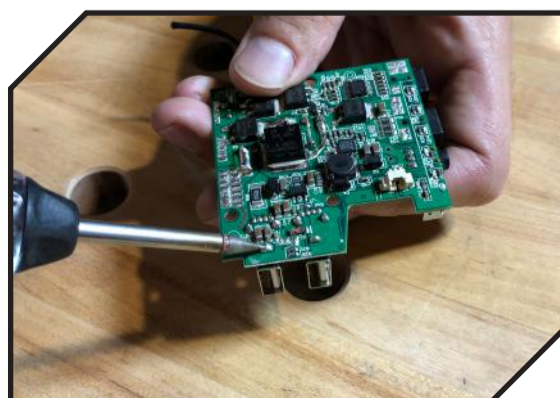
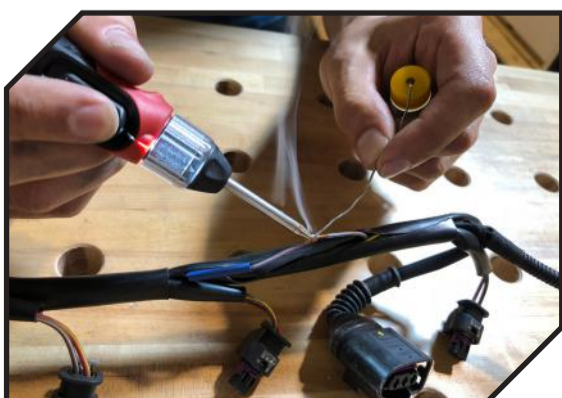

AIR BENDER BLOW GUN

HU14017

The air bender model reaches hard to access areas with a focused, high pressure, 90° angle output

- Intuitive and safe design allows the blow back to be away from your face
- Ideal for blowing out channels, ports, or reaching around obstructions

NEW

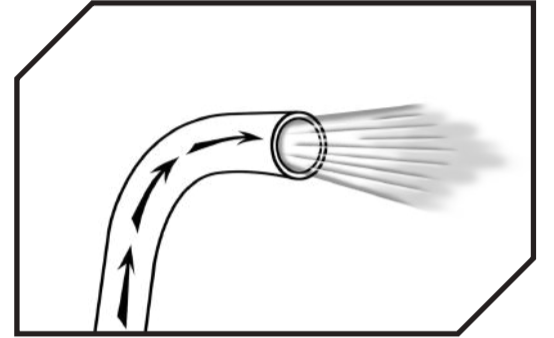

BLOW BACK GUN

HU14018

The blow back model dislodges and evacuates debris from the bottom of a bolt hole and out of all the threads

- 360° plus front air flow design
- Ideal for cleaning head bolt holes, manifolds and more

NEW

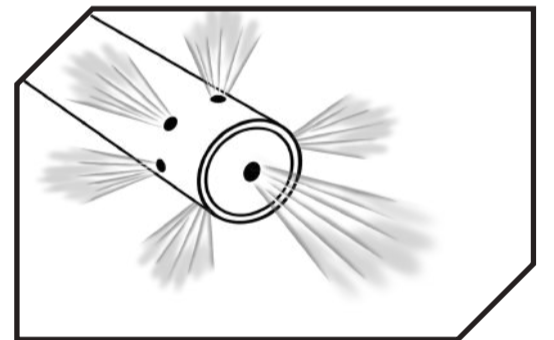
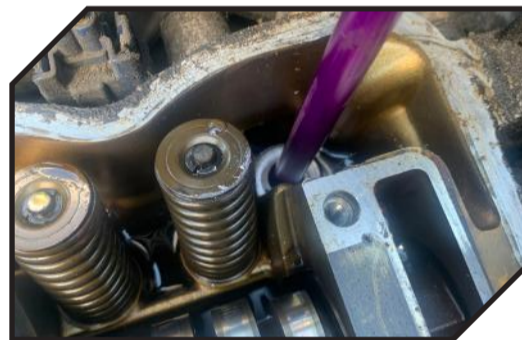

AIR SCRAPER BLOW GUN

HU14019

The Air Scraper model combines air pressure and scouring action to remove and blow away stuck on debris faster than other methods

- Designed with a stainless-steel shaft and hardened steel scraper tip
- Ideal for removing gasket materials hardened to a surface such as grease and rust

NEW

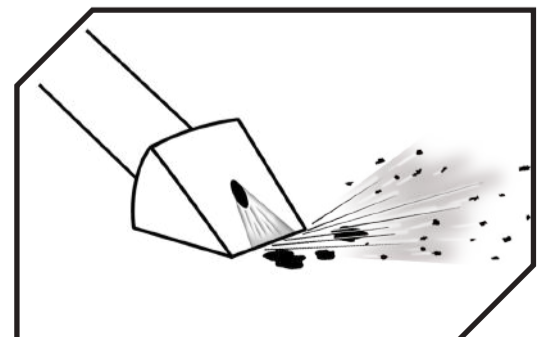

MICRO MALE ELECTRICAL PIN CLEANERS

HU45109

Super hard, diamond-coated contour files, specially designed to clean male electrical pins. The 3-piece set with included holster will remove corrosion from pin sizes .030»-.040», .060» and .090»-.098».

Features and Benefits :

- Super hard, abrasive, diamond coating
- Use on Deutsch, Cannon and similar connectors
- Automotive, HD, marine, industrial and military applications
- Includes leather-type holster

NEW



DIAMOND GRIP TERMINAL CLEANERS

HU45101

This 3-piece, pro-series set features three different size tips specifically designed and custom engineered to fit and clean most male/female flat pin-type connectors.

- Highly durable with mild abrasive coating
- Pivoting-handle design for added versatility
- Works for both male and female connectors on flat (spade) pin-type terminals
- Designed to clean and enhance electrical connections safely
- Reduces diagnostic guesswork
- Increase overall harness life
- Comes with a large, medium and small size cleaner for the most common
- Electrical connectors
- Includes a premium-quality holster with magnetic clasp
- Patented



SUPER HARD DIAMOND-COATED ROUND MICRO FILES

HU45102

- Super-hard, flexible, and diamond-coated for cleaning small, round, female electrical pins
- This 12-piece set of diamond micro round files are specially designed to remove corrosion from small-type Cannon, Deutsch, Bullet, NATO, Weather Pack and other small round terminal connections
- Strong but flexible
- Specifically engineered sizes designed for small round connector types
- Diameter sizes range from 0,75mm to 3,02mm and 127mm long
- For use in general filing applications such as steel, aluminum, plastic, brass, etc.
- Comes in a premium-quality holster with magnetic clasp
- Individual sizes are marked and available for replacements
- File Diameter Sizes:
0,75(2X)-0,98(2X)- 1,29-1,48-1,76-2,03-2,26-2,52-2,78-3,02mm

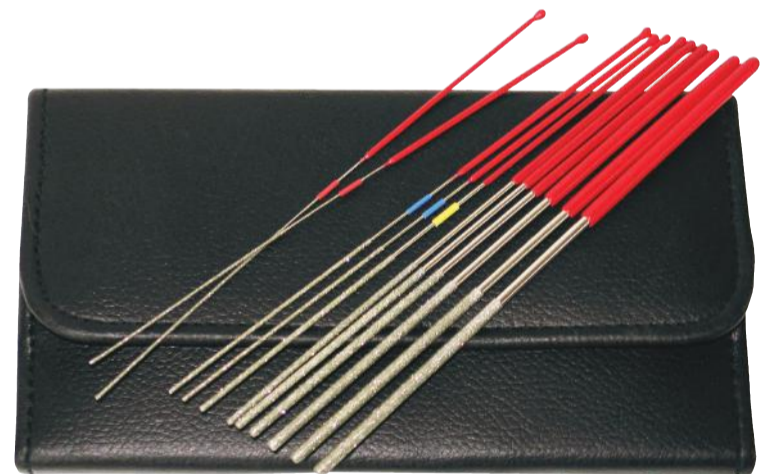

EUROPEAN TRAILER CONNECTOR CLEANERS

HU45103

- 3 piece set of single pole cleaners designed for the precise removal of corrosion and debris
- Cleans and resizes male and female 7 and 13 poles European trailer terminal connections
- Works on trailer light assemblies
- Extends harness life
- Maintains continuity to prevent circuit failure
- Premium quality holster with magnetic clasp
- Patented



Hubitools

FIND OUT MORE
ON OUR YOUTUBE CHANNEL



WWW.YOUTUBE.COM/HUBITOOLS

FOLLOW US



WWW.HUBITOOLS.COM