

Milwaukee®

Nothing but **HEAVY DUTY**.™



2023/24

ACCESSORIES, HAND TOOLS,
STORAGE AND PPE CATALOGUE

Milwaukee

Nothing but **HEAVY DUTY.**





CONTENTS

DRILLING AND CHISELING

CHISELS

HEX 21 mm/ 28 mm/ 30 mm	30-33
SDS-Max	19-23
SDS-Max Sledge Chisels	26-27
SDS-Plus	28
SDS-Plus Sledge Chisels	26-27

DIAMOND DRILLING

"1 1/4"" UNC / 1/2"" G - Wet Diamond Drilling Core Drills"	86-87
"1 1/4"" UNC / M16 - Dry Diamond Drilling Core Drills"	88-90
M14 Dry Diamond Drills	81-83
Wet/Dry Diamond Holesaws	84-85
Wet/Dry Diamond Holesaws	82

DRILLBITS: CONCRETE & MASONRY

Round Shank - Concrete/Masonry	36-37
SDS-Max - Other	23-25
SDS-Max 4 Cutter (MX4)	19-20
SDS-Max Core Cutters/Tunnel Bits	21-23
SDS-Plus 2 Cutter (M2)	8-11
SDS-Plus 4 Cutter (MX4)	4-7
SDS-Plus Core Cutters	18
SDS-Plus Extensions	17
Dust Management	14-17

DRILLBITS: METAL

HSS-G	58
HSS-G Red Cobalt	52-53
HSS-G Ti Red Hex - SHOCKWAVE™ IMPACT DUTY	50-51
HSS-R	59-60
Step Drills	61-64
Thunderweb	54-57

DRILLBITS: OTHER

Glass & Tile	36
Multi Material	34-35

DRILLBITS: WOOD

Auger Bits	39-40
Auger Bits - SHOCKWAVE™ IMPACT DUTY	38
Cable Bits	46
Flat Bits	45
Forstner Bits	41
Lip & Spur Bits	44
Selffeed Bits	43
SPEED FEED™ Bits	46
SWITCHBLADE™ Selffeed bits - SHOCK-WAVE™ IMPACT DUTY	42

HOLESAWS

Adjustable Holesaw	75
BIG HAWG™ Multi Material	78
Contractor Bi-Metal	74
HCS PVC Holesaws	79
HOLE DOZER™ Bi-Metal	69-72
HOLE DOZER™ Carbide	73
Holesaws - SHOCKWAVE™ IMPACT DUTY	80

FASTENING

Bit Holders - SHOCKWAVE™ IMPACT DUTY	99
Nails and Staples	116-119
Screwdriving Attachments	101-103
Screwdriving Bits	102-103
Screwdriving Bits - SHOCKWAVE™ IMPACT DUTY	93-98
Sockets & Adaptors - SHOCKWAVE™ IMPACT DUTY	104-115

SAWING, CUTTING & GRINDING

CUTTING AND GRINDING

Coated Abrasives

Belts	175-176
Orbital/ Random Orbital Delta Sheets	170-174

Diamond Technology

Diamond Blades	153-160
Diamond Grinding Cup Wheels	161

Grinding

Fixtec Nuts	168
Flap Discs	166-167
Metal Cutting Grinding Discs	163-165

SAWING

Bandsaw Blades	150-152
----------------	---------

Circular Saw Blades

Hand held circular saws	147-148
Mitresaws	149
Table saws	149
Steel/metal cutting blades	150

Jigsaw Blades

Metal	139-140
Special Applications	140-141
Wood & Plastics	137-138

Multitool Accessories

Starlock Reception	142-146
--------------------	---------

SAWZALL™ BLADES

Demolition Wood & Nails

The AX™ Carbide	128
The Ax™	129
Thin Kerf	129

Metal

The TORCH™ NITRUS / Carbide	122-123
The TORCH™	124-125
Thin Kerf	126-127

Multi material

The WRECKER™ Carbide	130
The Wrecker™	131
Sets	134

Special Applications

132-133	
---------	--

Wood & Plastics

132	
-----	--

HACKZALL™ Blades

135	
-----	--

OTHER TOOL ACCESSORIES

Angle Grinders	181
Bandsaws	189
Biscuit Joiners	189
Cable Cutters	196-197
Caulk Guns	207
Chucks	179-180
Circular Saws	189
Crimpers	192-195
Drain Cleaning	203
Dust Absorption Solutions	182
Electrical Test and Measuring	208
Expansion Tools	199
Fish Tapes M18 FUEL™	197
Heated Jackets	208
Hydraulic Pump	198
Impact Wrenches	177
Knockout Punch	198
Nibblers	183
Outdoor Products	191
Planers	190
Plate Shears	183
Polishers	184-186
Press Tools	200-202
Rotary hammers	178

Routers	190
Sanders	187-188
Screwdrivers	176
Vibrator Heads and Shafts	209

HANDTOOLS

Cutting

Bolt Cutters	236
Cable Cutter	235
Knives and Blades	227-230
Metal Snips	233
Scissors	232
Tubing Cutters	233-234

Demolition

Nail Puller	237
Pry Bars	266
Trim puller	237
Wrecking bar	237

Fish Tape

239	
-----	--

Gripping and Fastening

HOLLOWCORE™ Magnetic Nut Drivers	244
Pliers	246-250
Ratchets	259
Screwdrivers	241-245
Sockets	260-264
Spanners	255-258
TORQUE LOCK™ Clamps	251
TORQUE LOCK™ Pliers	250-251
Wrenches	252-254

Hammers

237-239	
---------	--

Hook & Pick Set

267	
-----	--

Measuring and Marking

Chalk Reel	224
Folding Rules	216-217
Framing Square	224
INKZALL™ Markers	225-226
Levels	218-223
Long Tapes	217
Rafter Square	224
Short Tapes	212-216

PERSONAL PROTECTIVE EQUIPMENT

Safety Glasses	271-272
Respirators	273-274
Heated Gear	294-298
High-Visibility Vests	276-277
Gloves	278-289
Lanyards	290-293
Knee Pads	303
Ear Plugs	275
PACKOUT™ First Aid Kit	275
Workwear	299-302

STORAGE

Steel Storage	304-307
Foam Inserts	308-311
PACKOUT™ Boxes	312-318
PACKOUT™ Trolleys	314
PACKOUT™ Organisers	319-320
PACKOUT™ Racking Systems	322
PACKOUT™ Bags	326-328
PACKOUT™ Shop Storage	329-330
Work Belts & Rigs	333



Nothing but **HEAVY DUTY**.™



4X

LIFE IN REBAR*

*vs. 2 cutter drill bit in concrete

At MILWAUKEE®, we strive to do things better. To make life easier in the toughest working conditions. We pour our energy into the relentless improvement of our products, and even the most minor improvements begin with understanding the challenges of the jobsite.

This intrinsic understanding of the challenge has led to the creation of our next generation MX4™, a game-changer in drill bit technology. Solid carbide construction means longer life, Target Tip Technology and a sharper angled tip means greater accuracy and next level speed in drilling through the toughest materials.

MX4™ is the benchmark in SDS-Plus and SDS-Max drill bits. Because at MILWAUKEE®, every bit matters.



NEW



TARGET TIP TECHNOLOGY

IMPROVED PERFORMANCE ON REBAR



FULL CARBIDE TIP*

FOR BEST PERFORMANCE

*≤10MM



SHARPER ANGLED TIP

IMPROVED REBAR PERFORMANCE

116 HOLES PER CHARGE*

* at a depth of 50mm with a 6mm MX4 drill bit, using a 5.5amp High output battery.

PRECISION GERMAN ENGINEERING

4 VARIABLE FLUTE DESIGN

FOR FASTER DRILLING



PGM RATED

FOR PRECISE DRILLING

NEW TARGET TIP TECHNOLOGY

SDS-Plus MX4 drill bits - 4 cut



Symmetrical 4 cutter geometry (4 x 90°). Perfect round holes for optimal anchor fitting. New sharper angled tip design for easy spot drilling with pinpoint accuracy and increased performance on rebar. One piece solid full welded carbide tip on 5-10 mm and one piece slotted carbide tip on 12-32 mm for best lifetime. 4 flute geometry: The high volume 4 flute geometry ensures the optimum removal of dust and debris. PGM rated. Made in Germany.

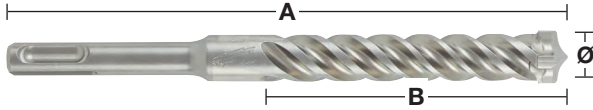
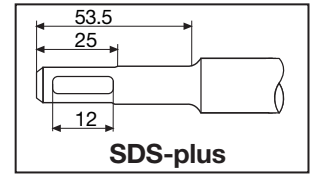

Diameter (mm)	Total length (mm) A	Working length (mm) B	Pre-drill	Pack quantity	Min. order quantity	Article Number	EAN Code
5	115	50		1	1	4932352007	4002395366644
5	165	100		1	1	4932352008	4002395368891
5	215	150		1	1	4932478465	4058546346560
5	265	200		1	1	4932478466	4058546346577
5	315	250		1	1	4932478467	4058546346584
5.5	115	50		1	1	4932352009	4002395368907
5.5	165	100		1	1	4932352010	4002395368914
5.5	215	150		1	1	4932478469	4058546346607
5.5	315	250		1	1	4932478470	4058546346614
6	115	50		1	1	4932352011	4002395368921
6	165	100		1	1	4932352012	4002395368938
6	215	150		1	1	4932352013	4002395366705
6	265	200		1	1	4932352014	4002395366712
6	315	250		1	1	4932352015	4002395366729
6.5	115	50		1	1	4932492017	4058546413293
6.5	165	100		1	1	4932430146	4002395378074
6.5	215	150		1	1	4932352016	4002395366736
6.5	265	200		1	1	4932352017	4002395366743
6.5	315	250		1	1	4932352018	4002395366750
6.5	465	400		1	1	4932464596	4058546225414
7	115	50		1	1	4932352019	4002395366767
7	165	100		1	1	4932352020	4002395366774
7	215	150		1	1	4932492018	4058546413309
8	115	50		1	1	4932352021	4002395366781
8	165	100		1	1	4932352022	4002395366798
8	215	150		1	1	4932352023	4002395366804
8	265	200		1	1	4932352024	4002395366811
8	315	250		1	1	4932352712	4002395373703
8	365	300		1	1	4932492019	4058546413316
8	465	400	✓	1	1	4932352713	4002395373710
9	165	100		1	1	4932352944	4002395376025
9	215	150		1	1	4932492020	4058546413323
10	115	50		1	1	4932352025	4002395366828
10	165	100		1	1	4932352026	4002395366835
10	215	150		1	1	4932352027	4002395366842
10	265	200		1	1	4932352028	4002395366859
10	315	250		1	1	4932352029	4002395366866
10	365	300		1	1	4932492021	4058546413330
10	455	400	✓	1	1	4932352030	4002395366873
10	600	540	✓	1	1	4932352945	4002395376032
10	1000	940	✓	1	1	4932352946	4002395376049
11	160	100		1	1	4932492022	4058546413347
11	210	150		1	1	4932492023	4058546413354
12	160	110		1	1	4932352031	4002395366880
12	210	160		1	1	4932352032	4002395366897
12	260	210		1	1	4932352033	4002395366903
12	310	260		1	1	4932352034	4002395366910
12	450	400	✓	1	1	4932352035	4002395366927
12	600	550	✓	1	1	4932352947	4002395376056
12	1000	940	✓	1	1	4932352948	4002395376063
13	160	100		1	1	4932492025	4058546413378
13	210	150		1	1	4932492026	4058546413385
14	160	110		1	1	4932352036	4002395366934
14	210	150		1	1	4932352037	4002395366941
14	260	200		1	1	4932352949	4002395376070
14	310	260		1	1	4932352038	4002395366958
14	380	330		1	1	4932478473	4058546346645
14	450	400	✓	1	1	4932352039	4002395366965

✓ Pre drill with a short drill bit of the same diameter.

SDS-Plus MX4 drill bits - 4 cut

✓ Pre drill with a short drill bit of the same diameter.

Diameter (mm)	Total length (mm) A	Working length (mm) B	Pre-drill	Pack quantity	Min. order quantity	Article Number	EAN Code
14	600	550	✓	1	1	4932352950	4002395376087
14	1000	950	✓	1	1	4932352951	4002395376094
15	160	100		1	1	4932430725	4002395383863
15	260	200		1	1	4932352952	4002395376100
15	450	400	✓	1	1	4932492027	4058546413392
16	160	110		1	1	4932430726	4002395383870
16	210	160		1	1	4932352953	4002395376117
16	260	210		1	1	4932352819	4002395374779
16	310	260		1	1	4932352954	4002395376124
16	450	400		1	1	4932352820	4002395374786
16	600	540	✓	1	1	4932352955	4002395376131
16	1000	950	✓	1	1	4932352956	4002395376148
17	210	150		1	1	4932478474	4058546346652
18	200	150		1	1	4932478899	4058546361815
18	250	200		1	1	4932356502	4002395320950
18	450	400	✓	1	1	4932356503	4002395320967
18	600	550	✓	1	1	4932492028	4058546413408
18	1000	940	✓	1	1	4932479345	4058546371395
20	250	200		1	1	4932356504	4002395320974
20	450	400	✓	1	1	4932356505	4002395320981
20	600	550	✓	1	1	4932492029	4058546413415
20	1000	940	✓	1	1	4932479346	4058546371401
22	250	200		1	1	4932399332	4002395359608
22	450	400	✓	1	1	4932356506	4002395320998
22	1000	940	✓	1	1	4932479347	4058546371418
24	250	200		1	1	4932356507	4002395321001
24	450	400	✓	1	1	4932356508	4002395321018
24	1000	940	✓	1	1	4932479348	4058546371425
25	250	200		1	1	4932399333	4002395359615
25	450	400	✓	1	1	4932356509	4002395321025
25	1000	940	✓	1	1	4932479349	4058546371432
28	250	200		1	1	4932399334	4002395359622
28	450	400	✓	1	1	4932356510	4002395321032
30	250	200		1	1	4932399335	4002395359639
30	450	400	✓	1	1	4932356511	4002395321049
32	450	400	✓	1	1	4932399336	4002395359646

SDS-Plus MX4 drill bits - 4 cut / 10 pack

Diameter (mm)	Total length (mm) A	Working length (mm) B	Pack quantity	Min. order quantity	Article Number	EAN Code
5	115	50	10	1	4932352040	4002395366972
5	165	100	10	1	4932471250	4058546288785
5.5	115	50	10	1	4932471251	4058546288792
5.5	165	100	10	1	4932352041	4002395366989
6	115	50	10	1	4932352042	4002395366996
6	165	100	10	1	4932352043	4002395367009
6	215	150	10	1	4932430234	4002395378951
6	265	200	10	1	4932471252	4058546288808
6.5	165	100	10	1	4932479556	4058546373504
6.5	215	150	10	1	4932430235	4002395378968
7	165	100	10	1	4932352044	4002395367016
8	115	50	10	1	4932352045	4002395367023
8	165	100	10	1	4932352046	4002395367030
8	265	200	10	1	4932471253	4058546288815
10	165	100	10	1	4932352047	4002395367047
10	215	150	10	1	4932352048	4002395367054
10	265	200	10	1	4932471254	4058546288822
10	315	250	10	1	4932471255	4058546288839
12	160	100	10	1	4932352049	4002395367061
12	210	150	10	1	4932352050	4002395367078
12	260	200	10	1	4932471256	4058546288846
14	210	150	10	1	4932471257	4058546288853
16	260	200	10	1	4932471258	4058546288860

SDS-Plus MX4 drill bits - 4 cut / 50 pack

Diameter (mm)	Total length (mm) A	Working length (mm) B	Pack quantity	Min. order quantity	Article Number	EAN Code
5.5	165	100	50	1	4932472234	4058546326302
6	115	50	50	1	4932430437	4002395380985
6	165	100	50	1	4932430438	4002395380992
6	215	150	50	1	4932430462	4002395381234
6.5	165	100	50	1	4932479557	4058546373511
6.5	215	150	50	1	4932430463	4002395381241
7	115	50	50	1	4932472154	4058546325503
7	165	100	50	1	4932472155	4058546325510
8	115	50	50	1	4932479368	4058546371623
8	165	100	50	1	4932430439	4002395381005
8	215	150	50	1	4932430440	4002395381012
8	315	250	50	1	4932472156	4058546325527
8	465	400	50	1	4932472157	4058546325534
10	115	50	50	1	4932479369	4058546371630
10	165	100	50	1	4932430441	4002395381029
10	215	150	50	1	4932430442	4002395381036
10	315	250	50	1	4932472158	4058546325541
10	455	390	50	1	4932472159	4058546325558
12	160	100	50	1	4932472160	4058546325565
12	210	150	50	1	4932430443	4002395381043
12	310	250	50	1	4932472161	4058546325572
12	450	400	50	1	4932472162	4058546325589
14	210	150	50	1	4932478097	4058546340308

SDS-Plus MX4 drill bits - 4 cut / sets

Description	Supplied in	Pack quantity	Min. order quantity	Article Number	EAN Code
SDS-Plus MX4 drill bit set (5pc)					
① Ø 5 / 6 x 115 mm, Ø 6 / 8 x 165 mm, Ø 10 x 165 mm	Plastic container	5	1	4932352833	4002395374915
SDS-Plus MX4 drill bit set (5pc)					
① Ø 5.5 x 115 mm, Ø 5.5 / 6 / 7 / 8 x 165 mm	Plastic container	5	1	4932352835	4002395374939
SDS-Plus MX4 drill bit set (7pc)					
② Ø 5 / 6 x 115 mm, Ø 6 / 8 / 8 / 10 x 165 mm, Ø 12 x 160 mm	Plastic cassette	7	1	4932478626	4058546348199
SDS-Plus MX4 drill bit set (7pc)					
② Ø 5.5 / 6 x 115 mm, Ø 5 / 5.5 / 6 / 8 / 10 x 165 mm	Plastic cassette	7	1	4932478627	4058546348205
Counter display SDS-Plus MX4 drill bit set (7pc)					
③ 6 x SDS-Plus MX4 7pc set (4932478626)	Plastic cassette	1	1	4932478673	4058546348663
Counter display SDS-Plus MX4 drill bit set (7pc)					
③ 6 x SDS-Plus MX4 7pc set (4932478627)	Plastic cassette	1	1	4932478674	4058546348670



Milwaukee®

Nothing but HEAVY DUTY.™



PROFESSIONAL

FAST DRILLING IN CONCRETE



25%
FASTER

3 BREAKER POINTS

*vs. previous generation



2
VARIABLE
FLUTE
DESIGN



2
CUTTER

IDEAL IN CONCRETE
DRILLING APPLICATIONS
WITH CORDLESS HAMMERS



SDS-Plus M2 drill bits - 2 cut

Made in Germany

FASTEST: New aggressive tip geometry with 3 chip breakers demolishes the concrete quicker and a tapered shoulder design minimises friction enabling the M2 drill bit to deliver faster drilling speed

DURABILITY: Rebar chamfers on the tip prevent side tip damage when hitting metal reinforcement and a thicker core body ensures higher power transfer, lower vibrations and less flute breakages

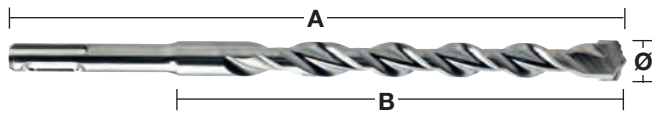
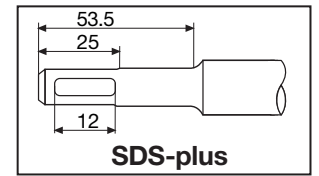

Diameter (mm)	Total length (mm) A	Working length (mm) B	Pre-drill	Pack quantity	Min. order quantity	Article Number	EAN Code
3	110	50		1	1	4932352892	4002395375509
3.5	110	50		1	1	4932373908	4002395353378
4	110	50		1	1	4932339498	4002395304561
4	160	100		1	1	4932399143	4002395357505
4.8	110	50		1	1	4932352130	4002395367832
5	110	50		1	1	4932307067	4002395308835
5	160	100		1	1	4932399315	4002395359431
5	210	150		1	1	4932399316	4002395359448
5.5	110	50		1	1	4932339499	4002395304578
5.5	160	100		1	1	4932340408	4002395311910
5.5	210	150		1	1	4932399317	4002395359455
5.5	260	200		1	1	4932399318	4002395359462
5.5	310	250		1	1	4932399319	4002395359479
5.5	410	350		1	1	4932399320	4002395359486
6	110	50		1	1	4932307068	4002395308842
6	160	100		1	1	4932307069	4002395308859
6	210	150		1	1	4932373136	4002395346394
6	260	200		1	1	4932353819	4002395320127
6	310	250		1	1	4932399321	4002395359493
6	460	400	✓	1	1	4932399322	4002395359509
6.5	110	50		1	1	4932344292	4002395312276
6.5	160	100		1	1	4932344293	4002395312269
6.5	210	150		1	1	4932399147	4002395357574
6.5	260	200		1	1	4932399148	4002395357581
6.5	310	260		1	1	4932399323	4002395359516
7	110	50		1	1	4932353820	4002395320134
7	160	100		1	1	4932340409	4002395311927
7	210	150		1	1	4932399222	4002395358366
7	250	200		1	1	4932399324	4002395359523
8	110	50		1	1	4932307070	4002395308866
8	160	100		1	1	4932307071	4002395308873
8	210	150		1	1	4932307072	4002395308880
8	260	200		1	1	4932353821	4002395320141
8	310	250		1	1	4932399325	4002395359530
8	400	350		1	1	4932399326	4002395359547
8	460	400	✓	1	1	4932367013	4002395336692
8	600	540	✓	1	1	4932399327	4002395359554
8	1000	940	✓	1	1	4932399328	4002395359561
9	160	100		1	1	4932353823	4002395320165
9	210	150		1	1	4932353822	4002395320158
10	110	50		1	1	4932340410	4002395311934
10	160	100		1	1	4932307073	4002395308897
10	210	150		1	1	4932307074	4002395308903
10	260	200		1	1	4932344295	4002395312252
10	310	250		1	1	4932353824	4002395320172
10	450	400	✓	1	1	4932344296	4002395312245
10	600	550	✓	1	1	4932367014	4002395336708
10	1000	950	✓	1	1	4932367015	4002395336715

✓ Pre drill with a short drill bit of the same diameter.

SDS-Plus M2 drill bits - 2 cut



Diameter (mm)	Total length (mm) A	Working length (mm) B	Pre-drill	Pack quantity	Min. order quantity	Article Number	EAN Code
11	160	100		1	1	4932367066	4002395336722
11	260	210		1	1	4932399329	4002395359578
12	160	110		1	1	4932307075	4002395308910
12	210	160		1	1	4932307076	4002395308927
12	260	210		1	1	4932344297	4002395312238
12	310	260		1	1	4932353825	4002395320189
12	450	400	✓	1	1	4932307077	4002395308934
12	600	550	✓	1	1	4932367068	4002395336746
12	1000	950	✓	1	1	4932367017	4002395336760
13	160	110		1	1	4932307946	4002395309054
13	260	210		1	1	4932344298	4002395312221
14	160	110		1	1	4932307078	4002395308941
14	210	160		1	1	4932353826	4002395320196
14	260	210		1	1	4932307079	4002395308958
14	310	260		1	1	4932399330	4002395359585
14	450	400	✓	1	1	4932307088	4002395309047
14	600	550	✓	1	1	4932367018	4002395336777
14	1000	950	✓	1	1	4932367019	4002395336784
15	160	110		1	1	4932373910	4002395353392
15	260	210		1	1	4932344300	4002395312207
16	160	110		1	1	4932307080	4002395308965
16	210	160		1	1	4932307081	4002395308972
16	260	210		1	1	4932399331	4002395359592
16	310	260		1	1	4932344301	4002395312191
16	450	400	✓	1	1	4932307082	4002395308989
16	600	550	✓	1	1	4932367069	4002395336791
16	1000	950	✓	1	1	4932367021	4002395336814
18	200	150		1	1	4932344303	4002395312177
18	250	200		1	1	4932307083	4002395308996
18	300	250		1	1	4932344304	4002395312160
18	450	400	✓	1	1	4932340411	4002395311941
18	600	550	✓	1	1	4932367022	4002395336821
18	1000	950	✓	1	1	4932367024	4002395336845
20	200	150		1	1	4932344305	4002395312153
20	250	200		1	1	4932307084	4002395309009
20	300	250		1	1	4932399027	4002395356126
20	450	400	✓	1	1	4932307085	4002395309016
20	600	550	✓	1	1	4932367025	4002395336876
20	1000	950	✓	1	1	4932367026	4002395336883
22	250	200		1	1	4932373911	4002395353408
22	450	400	✓	1	1	4932344307	4002395312139
22	600	550	✓	1	1	4932367027	4002395336890
22	1000	950	✓	1	1	4932367029	4002395336913
24	250	200		1	1	4932373922	4002395353521
24	450	400	✓	1	1	4932307087	4002395309030
25	250	200		1	1	4932344308	4002395312122
25	450	400	✓	1	1	4932344309	4002395312115
25	1000	950	✓	1	1	4932367030	4002395336975
26	250	200		1	1	4932344310	4002395323814
26	450	400	✓	1	1	4932344311	4002395312092

✓ Pre drill with a short drill bit of the same diameter.

SDS-Plus M2 drill bits - 2 cut / 10 pack

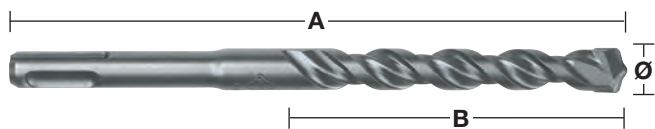

Diameter (mm)	Total length (mm) A	Working length (mm) B	Pack quantity	Min. order quantity	Article Number	EAN Code
5	110	50	10	1	4932371702	4002395344017
5	160	100	10	1	4932352520	4002395371785
5.5	110	50	10	1	4932352521	4002395371792
5.5	160	100	10	1	4932371703	4002395344024
6	110	50	10	1	4932371704	4002395344031
6	160	100	10	1	4932371705	4002395344048
6	210	150	10	1	4932399337	4002395359653
6.5	160	100	10	1	4932399338	4002395359660
6.5	210	150	10	1	4932399339	4002395359677
6.5	260	200	10	1	4932399340	4002395359684
7	160	100	10	1	4932373225	4002395348619
8	160	100	10	1	4932371706	4002395344055
8	210	150	10	1	4932399341	4002395359691
10	110	50	10	1	4932352522	4002395371808
10	160	100	10	1	4932371708	4002395344079
10	210	150	10	1	4932371709	4002395344086
10	260	200	10	1	4932399342	4002395359707
12	160	100	10	1	4932399343	4002395359714
12	210	160	10	1	4932371710	4002395344093
12	260	210	10	1	4932399344	4002395359721
14	260	210	10	1	4932371711	4002395344109

SDS-Plus M2 drill bits - 2 cut / 50 pack



Diameter (mm)	Total length (mm) A	Working length (mm) B	Pack quantity	Min. order quantity	Article Number	EAN Code
5	110	50	50	1	4932399176	4002395357833
5.5	160	100	50	1	4932399177	4002395357840
6	110	50	50	1	4932399178	4002395357857
6	160	100	50	1	4932399179	4002395357864
7	160	110	50	1	4932399181	4002395357888
8	160	100	50	1	4932399182	4002395357895
8	210	150	50	1	4932399183	4002395357901
10	160	110	50	1	4932399345	4002395359738
10	210	150	50	1	4932399184	4002395357918
10	260	200	50	1	4932399185	4002395357925
12	210	160	50	1	4932399186	4002395357932

SDS-Plus M2 drill bits - 2 cut / cassettes



Description	Pack quantity	Min. order quantity	Article Number	EAN Code
① SDS-Plus M2 drill bit set (5pc) Ø 5 / 6 x 110 mm and Ø 6 / 8 / 10 x 160 mm	5	1	4932352338	4002395369973
① SDS-Plus M2 drill bit set (5pc) Ø 5.5 x 110 mm and Ø 5.5 / 6 / 7 / 8 x 160 mm	5	1	4932352834	4002395374922
① SDS-Plus M2 drill bit set (5pc) Ø 10 / 12 / 14 / 16 / 20 x 450 mm	5	1	4932352801	4002395374595
② SDS-Plus M2 drill bit set (7pc) Ø 5 / 6 / 8 x 110 mm and Ø 6 / 8 / 10 / 12 x 160 mm	7	1	4932352339	4002395369980
③ Drill bit and chisel set (5pc) SDS-Plus drill bits Ø 6 / 8 / 10 x 160 mm, pointed and flat chisel	5	1	4932430002	4002395376636





Nothing but **HEAVY DUTY.**[™]

INVESTMENT IN CARBIDE



RESEARCH DEVELOPMENT
NEW TECHNOLOGIES

PROTOTYPING
RAPID PROTOTYPING



TESTING
COMPREHENSIVE TESTING

PRODUCTION
BEST IN CLASS PRODUCTION



SDS-PLUS

SDS-MAX

CHISELS



MADE IN GERMANY

SDS-Plus extensions

Universal SDS-Plus extensions to extend the reach of SDS-Plus drill bits.

Tool free drill bit click & connect system.

Fits to all SDS-Plus rotary hammers and drill bits.

Optimal for drilling around obstructions such as previously installed pipes and for overhead drilling.

Allows deep hole drilling e.g. rebar applications without buying an expensive long drill bit.

Diameter of the quick lock mechanism: 21 mm.



Length (mm)	Pack quantity	Min. order quantity	Article Number	EAN Code
300	1	1	4932471153	4058546287818
450	1	1	4932471154	4058546287825



DUST MANAGEMENT

Accurate concentricity and high dimensional accuracy drilled holes, according to PGM Conformity

Faster and more efficient drilling due to **99% dust removal**

Efficient drilling without dust for a safer and cleaner working environment

Active drill bit heads **cooling for a longer life**



SDS-Plus DUST-LOK dustless drill bits - 4 cut - Modular design

NEW

Efficient drilling without dust for a safer and cleaner work environment.
 Captures 99% of drilled dust.
 Active drill bit head cooling for a longer life.
 4 cutter design prevents the drill bit from jamming in the rebar.
 Accurate concentricity and high dimensional accuracy drilled holes, according to PGM.
 Universal connector for all common vacuum cleaners with hose diameter 32 - 38 mm.

	Diameter (mm)	Total length (mm) A	Working length (mm) B	Pack quantity	Min. order quantity	Article Number	EAN Code
①	5	136	100	1	1	4932471155	4058546287832
②	6	136	100	1	1	4932471156	4058546287849
③	8	136	100	1	1	4932471157	4058546287856
④	10	136	100	1	1	4932471158	4058546287863
⑤	12	136	100	1	1	4932471159	4058546287870
⑥	SDS-Plus DC arbor with vacuum adapter			1	1	4932471160	4058546287887
	SDS-Plus DC dustless drill bit set (6pc)						
⑦	∅ 5 / 6 / 8 / 10 / 12 x 136 mm. 1 x arbor with vacuum adapter			7	1	4932471162	4058546287900



Scan the QR Code to see our full video.

SDS-Plus dustless drill bits - 4 cut - One piece design

Faster and more efficient drill bit due to effective dust removal.
 Efficient drilling without dust for a safer and cleaner working environment.
 Active drill bit head cooling for a longer life.
 4 cutter design prevents the drill bit from jamming into the rebar.
 Accurate concentricity and high dimensional accuracy drilled holes, according to PGM Conformity.
 Universal connector for all common vacuum cleaners with hose diameter 32 – 38 mm.

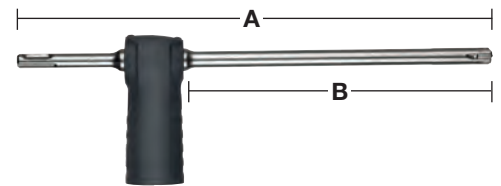

Diameter (mm)	Total length (mm) A	Working length (mm) B	Pack quantity	Min. order quantity	Article Number	EAN Code
12	325	200	1	1	4932459283	4058546002497
14	360	240	1	1	4932459284	4058546002503
16	360	240	1	1	4932459285	4058546002510

SDS-Max dustless drill bits - 4 cut - One piece design

Faster and more efficient drilling due to 99% dust removal.
 Efficient drilling without dust for a safer and cleaner working environment.
 Active drill bit head cooling for a longer life.
 4 cutter design prevents the drill bit from jamming in the rebar.
 Accurate concentricity and high dimensional accuracy drilled holes, according to PGM Conformity.
 Universal connector for all common vacuum cleaners with hose diameter 32 – 38 mm.

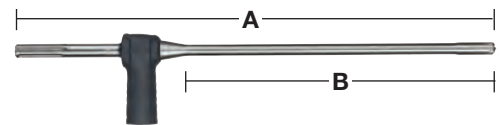

Diameter (mm)	Total length (mm) A	Working length (mm) B	Pack quantity	Min. order quantity	Article Number	EAN Code
16	600	400	1	1	4932459287	4058546002534
18	600	400	1	1	4932459288	4058546002541
20	600	400	1	1	4932459289	4058546002558
22	600	400	1	1	4932459290	4058546002565
24	600	400	1	1	4932459291	4058546002572
25	600	400	1	1	4932459292	4058546002589
28	600	400	1	1	4932459293	4058546002596
28	900	900	1	1	4932459294	4058546002602
30	600	400	1	1	4932459295	4058546002619
30	900	700	1	1	4932459296	4058546002626
32	600	400	1	1	4932459297	4058546002633
32	900	700	1	1	4932459298	4058546002640
35	900	700	1	1	4932459300	4058546002664
Universal vacuum cleaner adaptor			1	1	4931416173	4002395805501

PCHDE - Universal chiselling dust extraction system

Universal dust extraction solution fitting to all brands of SDS-Max hammers.

Collects over 90% of chiselled dust.

Saves valuable post cleaning time.

Fits to Milwaukee® vacs with easy and secure click system.

Can only be used with DE type chisels listed below.

The following spare parts are available for a quick turnaround: spring (4931328988), rubber rings (5 pc) (4931455278), main housing (4931449576) and front hose with plastic nose (4931455277)



Description	Pack quantity	Min. order quantity	Article Number	EAN Code
PCHDE: Includes 1 x SDS-Max point chisel	1	1	4932455280	4002395247943
PCHDE: Includes 1 x SDS-Max flat chisel	1	1	4932455275	4002395247936
SDS-Max DE point chisel 400 mm long	1	1	4932455144	4002395247981
SDS-Max DE flat chisel 400 mm long	1	1	4932455145	4002395247974

Dust guard

Prevents dust and dirt entering the tool reception area when using spades and ground rod drivers.

Description	Pack quantity	Min. order quantity	Article Number	EAN Code
Dust guard cap	1	1	9170086960	4002395565504



Rotary hammer dust extraction

Description	Pack quantity	Min. order quantity	Article Number	EAN Code
① Dust collection ring for collecting dust when overhead drilling. Suitable for Ø 5 - 8 mm	1	1	4932430912	4002395385744
② Extractor for dust collection on the wall or when overhead drilling. Maximum diameter drill bit Ø 28 mm. Fits to all industrial dust extraction units (universal reception Ø 26 - 41 mm)	1	1	4932430446	4002395381074
③ Drilling shroud - PHDE72. For drilling and coring from Ø 6 - 72 mm. Brush insert to improve suction and extraction. Brushes to be removed for coring applications. Outlet nozzle: Ø 37 mm outside / Ø 32 mm inside. Replacement sealing lips (2 pcs): 4931448564. Replacement brush: 4931448565	1	1	4932430480	4002395381418
④ Drilling shroud - PHDE152	1	1	4932471990	4058546298890

①



②



③



④



DE16 - Vac assist universal extractor

⑤ DE16 unit, 1 x side handle and 3 x neck collars- allows fitting to drills with gear neck from Ø 43 - 59 mm. 2 x drilling nozzles (49902301)	1	1	4932430835	4002395384976
---	---	---	------------	---------------

⑤



SDS-Plus dust trap

Universal fit - Fits ALL SDS-Plus rotary hammer brands and styles.
 Fits ALL SDS-Plus drill bits up to 215mm total length.
 Fits ALL standard vacuum cleaners.
 Clear sleeve for visibility & accuracy.
 Collects up to 99% of airborne dust.
 Useable with or without vacuum cleaner.



Description	Pack quantity	Min. order quantity	Article Number	EAN Code
SDS-Plus dust trap	1	1	4932464916	4058546228613
SDS-Plus dust trap sleeve	1	1	4932464917	4058546228620



SDS-Max chisel boot

Universal fit - Fits ALL standard SDS-Max rotary hammer brands and styles.
 Universal fit to pointed and flat chisels up to 400mm length and 25mm tip width.
 Slim design for reaching tight areas.
 Hose clip adapter for easy attachment to MILWAUKEE® vacuum cleaners.



Description	Pack quantity	Min. order quantity	Article Number	EAN Code
SDS-Max chisel boot	1	1	4932471991	4058546298906

Breaker boot

Universal fit - Fits most 28 & 30 mm breaking hammers. Perfect match to 28 mm MX FUEL™ breaker.
 Universal fit to pointed and flat chisels.
 Slim design for reaching tight areas.
 Hose clip adapter for easy attachment to MILWAUKEE® vacuum cleaners.



Description	Pack quantity	Min. order quantity	Article Number	EAN Code
Breaker boot	1	1	4932471992	4058546298913

SDS-Plus TCT core cutters

Core cutters for rotary hammers up to 4 kg.
 All TCT cores have a M16 x 2 thread and fit to both SDS-Plus and Hex 11 arbors.
 Arbor and pilot drill bit required additionally.
 Made in Germany.
 Not suitable for reinforced concrete.

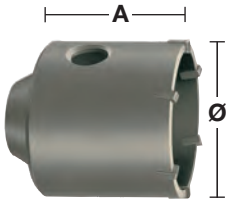
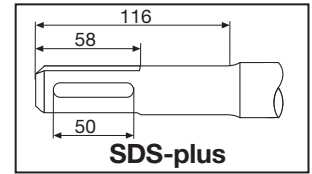

Diameter (mm)	Total length (mm) A	Pack quantity	Min. order quantity	Article Number	EAN Code
35	58	1	1	4932344478	4002395312559
50	58	1	1	4932344479	4002395312566
65	50	1	1	4932344480	4002395312573
68	50	1	1	4932399099	4002395357031
82	50	1	1	4932344481	4002395312580
90	50	1	1	4932344482	4002395312597
100	50	1	1	4932480689	4058546409746

SDS-Plus TCT core cutter - set

Set version includes: TCT core cutter, SDS-Plus arbor 105 mm length, TCT pilot drill bit Ø 8 x 120 mm and allen key.

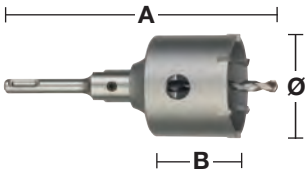

Diameter (mm)	Total length (mm) A	Working length (mm) B	Pack quantity	Min. order quantity	Article Number	EAN Code
65	182	50	4	1	4932399295	4002395359097
68	182	50	4	1	4932399296	4002395359103
82	182	50	4	1	4932399297	4002395359110

SDS-Plus TCT core cutter arbors

Both SDS-Plus and Hex arbors include an allen key and require a pilot drill bit additionally.

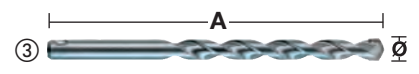
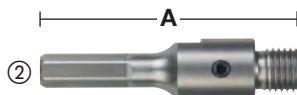
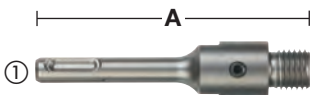

Description	Reception	Diameter (mm)	Total length (mm) A	Pack quantity	Min. order quantity	Article Number	EAN Code
① SDS-plus arbor	SDS-Plus		105	2	1	4932399966	4002395366255
① SDS+ Arbor for SDS-Max TCT core cutters	SDS-Plus		115	1	1	4932480690	4058546409753
① SDS-plus arbor	SDS-Plus		370	2	1	4932399967	4002395366262
② Hex arbor	11 mm Hex		90	2	1	4932399968	4002395366279
③ TCT pilot drill bit for use in masonry, concrete, brick etc.		8	120	1	1	4932399125	4002395357291



DRILL TO THE MAX.

SDS-MAX MX4™ DRILL BITS

Milwaukee Tool leads the way in accessories development and technology for the professional job site. Our relentless pursuit of innovation has resulted in the Next Generation MX4™ SDS-MAX drill bits, our most powerful and durable drill bit for toughest tasks on the job site.

Driven and developed by countless hours on the jobsite, MILWAUKEE® has created MX4™ SDS-MAX as a drill bit designed to offer the fastest performance and longest lifespan when drilling in reinforced concrete. Featuring MILWAUKEE® exclusive Target Tip Technology, SDS-MAX is larger than the standard SDS-PLUS bits, providing improved accuracy and performance in rebar as well as other heavy-duty applications.



NEW



TARGET TIP TECHNOLOGY



SHARPER ANGLED TIP
IMPROVED REBAR PERFORMANCE

2X

LIFE IN REBAR*

* Vs previous generation

4 VARIABLE FLUTE DESIGN*

FOR FASTER DRILLING

PRECISION GERMAN ENGINEERING

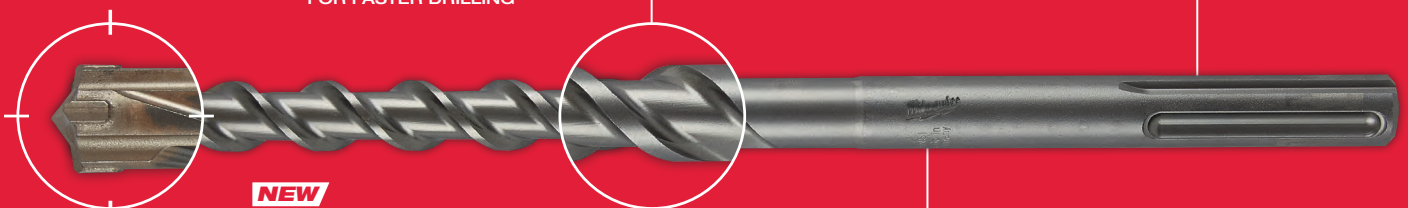

NEW



TARGET TIP TECHNOLOGY



PGM RATED

FOR PRECISE DRILLING

*Variable 4 flute design for diameters up to 16mm, all larger diameters have a variable 2 flute design.

SDS-Max MX4 drill bits - 4 cut

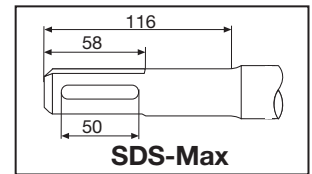
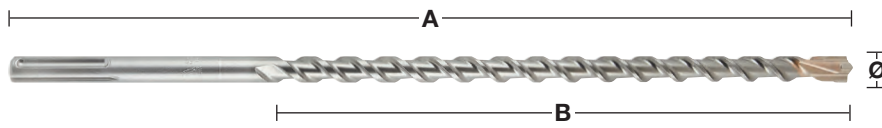

Diameter (mm)	Total length (mm) A	Working length (mm) B	Pre-drill	Pack quantity	Min. order quantity	Article Number	EAN Code
12	340	200		1	1	4932352750	4002395374083
12	540	400	✓	1	1	4932352751	4002395374090
12	690	550		1	1	4932430727	4002395383887
14	340	200		1	1	4932352752	4002395374106
14	540	400	✓	1	1	4932352753	4002395374113
15	340	200		1	1	4932352754	4002395374120
15	540	400	✓	1	1	4932352755	4002395374137
16	340	200		1	1	4932352756	4002395374144
16	540	400	✓	1	1	4932352757	4002395374151
16	940	800	✓	1	1	4932352758	4002395374168
16	1320	1180	✓	1	1	4932352759	4002395374175
18	340	200		1	1	4932352760	4002395374182
18	540	400	✓	1	1	4932352761	4002395374199
18	940	800	✓	1	1	4932352762	4002395374205
18	1320	1180	✓	1	1	4932352763	4002395374212
20	320	200		1	1	4932352764	4002395374229
20	520	400	✓	1	1	4932352765	4002395374236
20	920	800	✓	1	1	4932352766	4002395374243
20	1320	1200	✓	1	1	4932352767	4002395374250
22	320	200		1	1	4932352768	4002395374267
22	520	400	✓	1	1	4932352769	4002395374274
22	920	800	✓	1	1	4932352770	4002395374281
22	1320	1200	✓	1	1	4932352771	4002395374298
24	320	200		1	1	4932352772	4002395374304
24	520	400	✓	1	1	4932352773	4002395374311
25	320	200		1	1	4932352774	4002395374328
25	520	400	✓	1	1	4932352775	4002395374335
25	920	800	✓	1	1	4932352776	4002395374342
25	1320	1200	✓	1	1	4932352777	4002395374359
26	520	400		1	1	4932430728	4002395383894
28	370	250		1	1	4932352778	4002395374366
28	570	450	✓	1	1	4932352779	4002395374373
28	670	550	✓	1	1	4932352780	4002395374380
28	920	800	✓	1	1	4932352781	4002395374397
28	1320	1200	✓	1	1	4932352782	4002395374403
30	370	250		1	1	4932352783	4002395374410
30	570	450		1	1	4932352784	4002395374427
30	920	800		1	1	4932430729	4002395383900
32	370	250		1	1	4932352785	4002395374434
32	570	450		1	1	4932352786	4002395374441
32	920	800	✓	1	1	4932352787	4002395374458
32	1320	1200	✓	1	1	4932352788	4002395374465
35	370	250		1	1	4932352789	4002395374472
35	570	450		1	1	4932352790	4002395374489
35	920	800	✓	1	1	4932352791	4002395374496
38	370	250		1	1	4932352792	4002395374502
38	570	450		1	1	4932352793	4002395374519
40	370	250		1	1	4932352794	4002395374526
40	570	450	✓	1	1	4932352795	4002395374533
40	920	800	✓	1	1	4932352796	4002395374540
40	1320	1200	✓	1	1	4932352797	4002395374557
45	570	450		1	1	4932352798	4002395374564
45	920	800		1	1	4932430730	4002395383917
50	570	450		1	1	4932430731	4002395383924
52	570	450		1	1	4932352799	4002395374571
SDS-Max drill bits set (5pc) Ø 16 / 18 x 540 mm, Ø 20 / 22 / 25 x 520 mm				5	1	4932352800	4002395374588

✓ Pre drill with a short drill bit of the same diameter.

additional length available upon request

SDS-Max TCT tunnel drill bits - One piece design

NEW

One piece solid steel tool.
 Premium 3 cutter centering drill bit.
 Massive head with 3 large dust removal channels.
 Rebar chamfers to prevent side tip damage when hitting metal reinforcement.
 Suitable for reinforced concrete.
 Made in Germany.

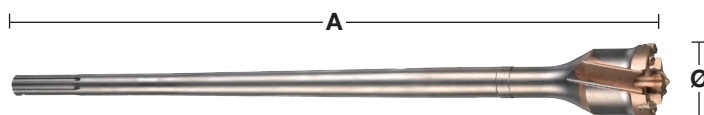
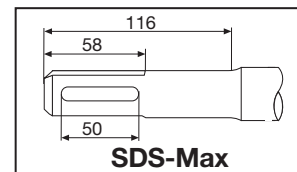

Diameter (mm)	Total length (mm) A	Pack quantity	Min. order quantity	Article Number	EAN Code
40	550	1	1	4932492053	4058546414207
45	550	1	1	4932492054	4058546414214
45	990	1	1	4932492055	4058546414221
55	550	1	1	4932492056	4058546414238
55	990	1	1	4932492057	4058546414245
65	550	1	1	4932492058	4058546414252
65	990	1	1	4932492059	4058546414269
80	550	1	1	4932492060	4058546414276
80	990	1	1	4932492061	4058546414283

SDS-Max TCT core cutters - One piece design

One piece solid steel tool.
 Increased lifetime.
 Supplied with pilot drill bit and ejector tool.
 Made in Germany.
 Not suitable for reinforced concrete.

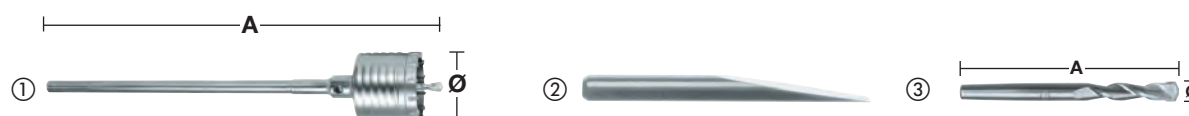

Description	Diameter (mm)	Total length (mm) A	Pack quantity	Min. order quantity	Article Number	EAN Code
①	50	290	1	1	4932399373	4002395359905
	50	550	1	1	4932373884	4002395353132
	68	290	1	1	4932399374	4002395359912
	68	550	1	1	4932373885	4002395353149
	80	290	1	1	4932399375	4002395359929
	80	550	1	1	4932373886	4002395353156
	100	550	1	1	4932373888	4002395353170
	125	550	1	1	4932373889	4002395353187
	150	550	1	1	4932373890	4002395353194
② Ejector tool			1	1	4932399021	4002395356065
③ Pilot drill bit	11	120	1	1	4932245967	4002395307111

SDS-Max TCT core cutters - Two piece design

Not suitable for rotary hammers > 10 kg.

Made in Germany.

Not suitable for reinforced concrete.

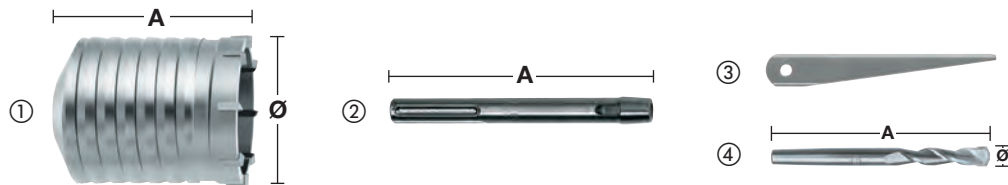

Description	Diameter (mm)	Total length (mm) A	Pack quantity	Min. order quantity	Article Number	EAN Code
① TCT core cutter	40	100	1	1	4932245992	4002395307180
	50	100	1	1	4932430732	4002395383931
	60	100	1	1	4932430733	4002395383948
	65	100	1	1	4932245994	4002395307203
	68	100	1	1	4932430734	4002395383955
	80	100	1	1	4932245995	4002395307210
	90	100	1	1	4932430735	4002395383962
	100	100	1	1	4932367304	4002395336432
	125	100	1	1	4932367306	4002395336456
② Arbor SDS-Max	150	100	1	1	4932367308	4002395336470
	-	180	1	1	4932343667	4002395315932
	-	450	1	1	4932343670	4002395315949
③ Ejector tool	-	-	1	1	4932604214	4002395311231
④ Pilot drill bit	11	120	1	1	4932245967	4002395307111

SDS-Max to SDS-Plus chuck adaptor



Description	Tool reception	Drill reception	Pack quantity	Min. order quantity	Article Number	EAN Code
SDS-Max to SDS-Plus chuck adaptor	SDS-Max	SDS-Plus	1	1	4932359490	4002395325795

SDS-Max vario extension system

Flexible tool system: can be extended to variable lengths in combination with core cutters or tunnel bits.

We recommend a maximum of 3 extensions.

Cost effective: different drill sizes can be exchanged easily and fast with the threaded stud system.

Suitable for rotary hammers up to 8 kg.

Vario tunnel bits (supplied with thread).

Not suitable for reinforced concrete.

Description	Diameter (mm)	Total length (mm) A	Pack quantity	Min. order quantity	Article Number	EAN Code
① SDS-Max arbor with internal thread	-	195	1	1	4932430736	4002395383979
② Vario extension (incl. threaded stud)	25	280	1	1	4932430737	4002395383986
③ Vario threaded stud	-	-	1	1	4932430738	4002395383993
④ Vario threaded stud with tapered end 1:8 for TCT core cutters	-	-	1	1	4932430748	4002395384099
⑤ TCT core cutter	40	100	1	1	4932245992	4002395307180
	50	100	1	1	4932430732	4002395383931
	60	100	1	1	4932430733	4002395383948
	65	100	1	1	4932245994	4002395307203
	68	100	1	1	4932430734	4002395383955
	80	100	1	1	4932245995	4002395307210
	90	100	1	1	4932430735	4002395383962
	100	100	1	1	4932367304	4002395336432
	125	100	1	1	4932367306	4002395336456
	150	100	1	1	4932367308	4002395336470
⑥ Ejector tool	-	-	1	1	4932604214	4002395311231
⑦ Pilot drill bit	11	120	1	1	4932245967	4002395307111
⑧ Vario tunnel drill bits (supplied with thread)	30	150	1	1	4932430739	4002395384006
	35	150	1	1	4932430740	4002395384013
	40	150	1	1	4932430743	4002395384044
	45	150	1	1	4932430744	4002395384051
	55	150	1	1	4932430745	4002395384068
	60	150	1	1	4932430741	4002395384020
	68	150	1	1	4932430746	4002395384075
	80	150	1	1	4932430747	4002395384082
	90	150	1	1	4932430742	4002395384037

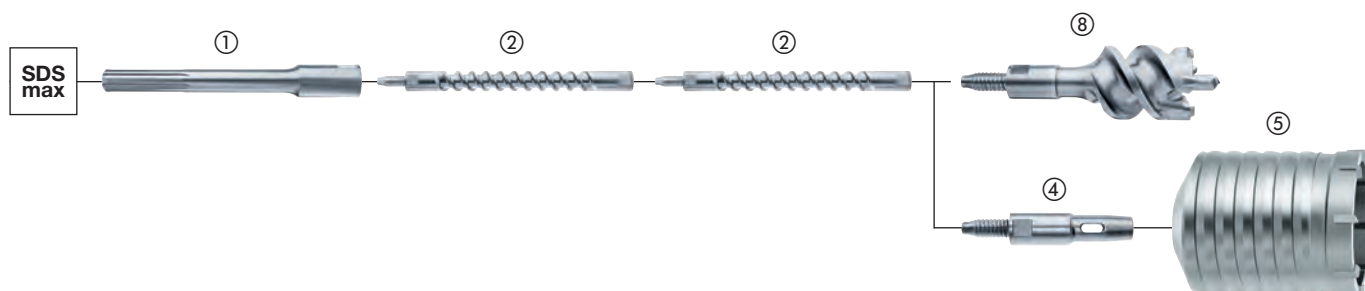
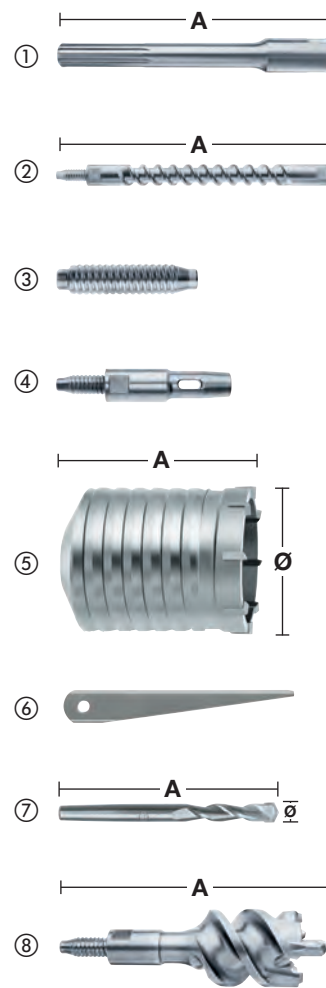



Nothing but **HEAVY DUTY.**[™]

Drill Connect

The innovative and patented Drill Connect System is the ultimate solution for those requiring maximum versatility with large diameter drilling tools.

Versatile:

Drill Connect acts as a link between machine and drilling tools. On one side the system is totally compatible to all SDS-Max reception drilling tools such as drill bits, tunnel bits and core cutters. On the opposite side, between the rotary hammer and the Drill Connect attachment, one can fit the extension piece with the desired length.

Cost effective:

Professional users always require both long and short length drill bits and depending on the application sometimes even of the same diameter. But now, one can reduce the total number of drilling tools with the help of the Drill Connect System which makes it possible to interchange the drilling tools diameter and length in one simple step. Therefore users can reap the benefits of purchasing the cheaper short length drill bits and extending the length with the economical extensions plus the flexibility of Drill Connect reduces the overall quantity of drill bits one must carry in their toolbox.

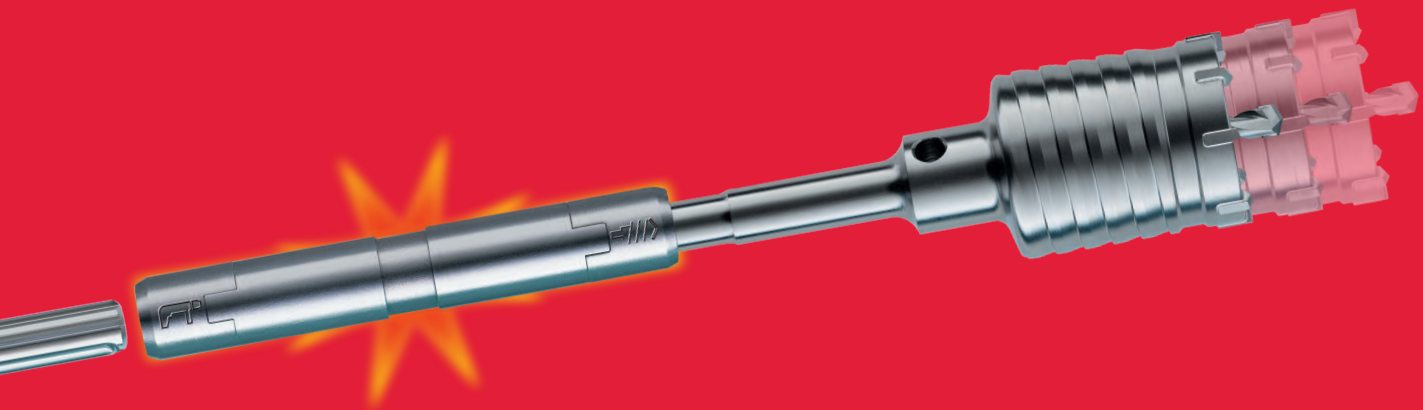

100% Power:

The Drill Connect attachment provides a quick and safe connection between drilling tool and extension piece and therefore ensures that 100% of the power is completely transmitted to the drill bit tip.



Less weight:

The combination of short drilling tools and 18 mm diameter extensions reduces the overall weight by up to 15%.

- We recommend that Drill Connect be cleaned of concrete dust and lubricated with grease at regular intervals (Grease – Part-no. 4932352273).
- Drill Connect is only suitable for drilling tools in excess of 32 mm diameter and limited for use with rotary hammers up to 8 kg in weight.

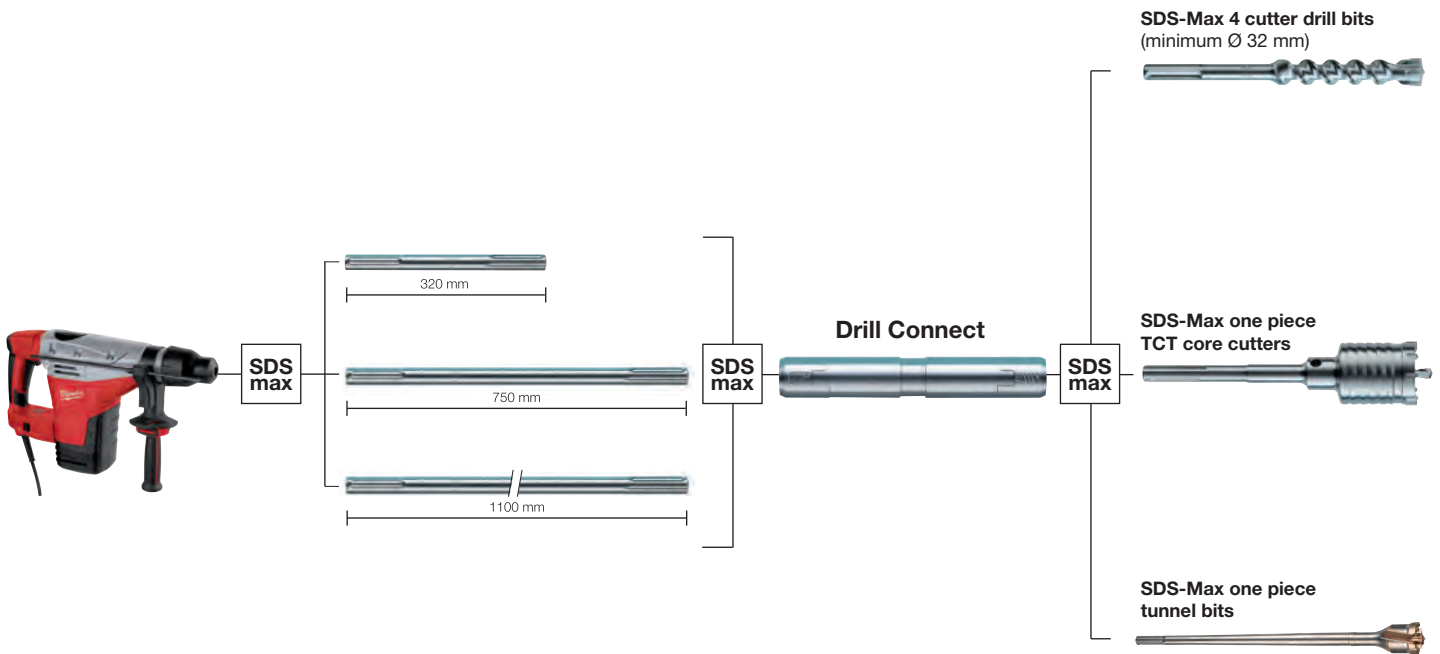

Drill connect

Suitable for use with drilling tools with a Ø of 32 mm and above.
For use with rotary hammers up to 8 kg in weight.

Description	Tool reception	Drill connect reception	Total length (mm) A	Pack quantity	Min. order quantity	Article Number	EAN Code
Drill connect	SDS-Max	SDS-Max	190	1	1	4932399128	4002395357321

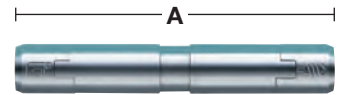

Extension pieces

Description	Tool reception	Drill connect reception	Length (mm) A	Pack quantity	Min. order quantity	Article Number	EAN Code
SDS-Max extension	SDS-Max	SDS-Max	320	1	1	4932399242	4002395358533
SDS-Max extension	SDS-Max	SDS-Max	750	1	1	4932399129	4002395357338
SDS-Max extension	SDS-Max	SDS-Max	1100	1	1	4932399243	4002395358540

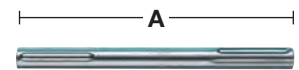

Grease

This grease has been specially formulated to lubricate and protect both the tool and accessories ensuring increased lifetime.

Apply sparingly directly onto the reception of the drill bit, chisel or core cutter, etc.
Contains 50 grams.

Description	Pack quantity	Min. order quantity	Article Number	EAN Code
Grease	1	1	4932352273	4002395369324
Counter display with 15 x single grease tube	15	1	4932352274	4002395369331





Nothing but **HEAVY DUTY.**[™]

SLEDGE[™] CHISELS

2X
MORE LIFE
*VS STANDARD CHISELS

Our SLEDGE[™] Chisels stay sharper for longer. Reinforced edges deliver maximum durability and reduced wear over the life of the chisel. We've engineered these chisels to maintain sharper edges for increased productivity with an optimized tip for fast removal of concrete, rust, cutting troughs, and asphalt.

No re-sharpening or re-hardening necessary for reduced downtime. High grade forged steel for maximum durability and longer life in concrete demolition over our standard scraping chisels. For use with SDS-Plus & Max rotary hammers.

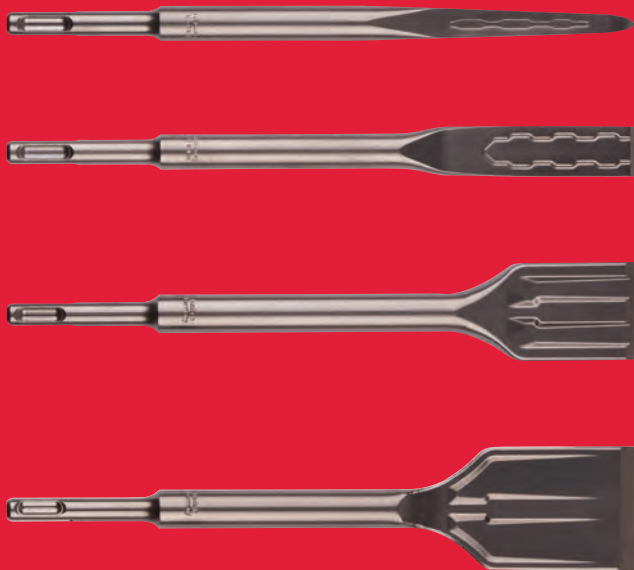

EXTRA LONG
WORKING LENGTH

**SELF-SHARPENING
TIP**

MADE IN
GERMANY

RE-GRINDED TIP
STAYS SHARPER, BEST PERFORMANCE AND AVOIDS JAMMING

Scan the
QR Code
to see our
full video.



SDS-Plus SLEDGE™ self sharpening chisels

Up to 2x longer life compared to standard chisels.
 Self-sharpening tip geometry.
 Extra long working length for more material removal.
 Re-grinded tip stays sharper for longer and avoids jamming.
 Made in Germany.

Description	Total length (mm)	Blade width (mm)	Pack quantity	Min. order quantity	Article Number	EAN Code
① SDS-Plus SLEDGE™ pointed chisel	250	-	1	1	4932478262	4058546344399
			10	1	4932478272	4058546344498
② SDS-Plus SLEDGE™ flat chisel	250	20	1	1	4932478263	4058546344405
			10	1	4932478273	4058546344504
③ SDS-Plus SLEDGE™ wide chisel	250	40	1	1	4932478264	4058546344412
④ SDS-Plus SLEDGE™ tile chisel	250	50	1	1	4932478265	4058546344429



SDS-Max SLEDGE™ self sharpening chisels

Up to 2x longer life compared to standard chisels.
 Self sharpening tip geometry.
 Extra long working length for more material removal.
 Re-grinded tip stays sharper for longer and avoids jamming.
 Made in Germany.

Description	Total length (mm)	Blade width (mm)	Pack quantity	Min. order quantity	Article Number	EAN Code
① SDS-Max SLEDGE™ pointed chisel	400	-	1	1	4932478266	4058546344436
			20	1	4932478274	4058546344511
② SDS-Max SLEDGE™ flat chisel	400	25	1	1	4932478267	4058546344443
			20	1	4932478275	4058546344528
③ SDS-Max SLEDGE™ 2 wide chisel	380	50	1	1	4932478268	4058546344450
④ SDS-Max SLEDGE™ 3 wide chisel	300	80	1	1	4932478269	4058546344467
⑤ SDS-Max SLEDGE™ tile chisel	380	50	1	1	4932478270	4058546344474
⑥ SDS-Max SLEDGE™ tile chisel	300	50	1	1	4932478271	4058546344481
⑦ SDS-Max floor scraping tool	635	152	1	1	4932480474	4058546407599
SDS-Max floor scraping service set (10pc)			10	1	4932480475	4058546407605
1 x blade 152x180x1.5 mm, 1 x clamping blade, 4 x nuts, 4 x countersunk bolts						

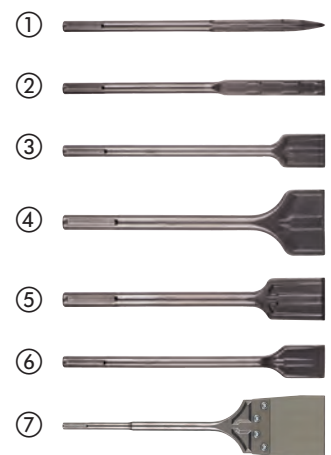

SDS-Plus chisels

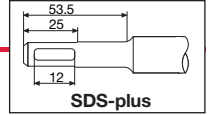

Description	Total length (mm)	Blade width (mm)	Pack quantity	Min. order quantity	Article Number	EAN Code
① SDS-Plus thin pointed chisel	180	-	1	1	4932451731	4002395276813
② SDS-Plus pointed chisel	250	-	1	1	4932339625	4002395304813
③ SDS-Plus thin flat chisel	180	14	1	1	4932451732	4002395276820
④ SDS-Plus flat chisel	250	20	1	1	4932339626	4002395304820
⑤ SDS-Plus wide chisel	250	40	1	1	4932367146	4002395334377
⑥ SDS-Plus 3 pc chisel set: 1 x Pointed chisel, 1 x Flat chisel, 1 x Wide chisel	250	-	3	1	4932430001	4002395376629
⑦ SDS-Plus tile removal chisel	250	40	1	1	4932353424	4002395320202
⑧ SDS-Plus gouge chisel	250	22	1	1	4932339627	4002395304837
⑨ SDS-Plus plaster removal chisel	165	75	1	1	4932352344	4002395370030
⑩ SDS-Plus floor / wall scraper	250	100	1	1	4932352919	4002395375776
Spare 1 mm thick floor / wall scraper blade with 3 x bolts / nuts	-	-	1	1	4932352920	4002395375783
⑪ SDS-Plus mortar chisel	125	32	1	1	4932472029	4058546324254
	200	32	1	1	4932472030	4058546324261
⑫ SDS-Plus wing chisel	250	22	1	1	4932479900	4058546376949

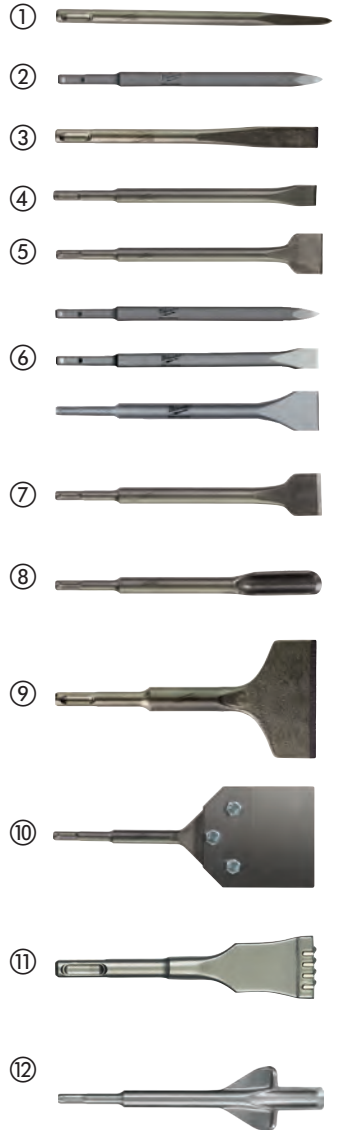

SDS-Max chisels

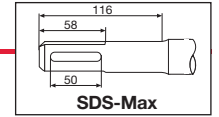

Description	Total length (mm)	Blade width (mm)	Pack quantity	Min. order quantity	Article Number	EAN Code	
① SDS-Max pointed chisel	280	-	1	1	4932343734	4002395317509	①
	400	-	1	1	4932343735	4002395317516	
	400	-	20	1	4932399302	4002395359165	
	600	-	1	1	4932343736	4002395317523	
② SDS-Max flat chisel	280	25	1	1	4932343737	4002395317530	②
	400	25	1	1	4932343738	4002395317547	
	400	25	20	1	4932399303	4002395359172	
	600	25	1	1	4932343739	4002395317554	
③ SDS-Max wide chisel	400	50	1	1	4932343743	4002395317592	③
	300	80	1	1	4932343744	4002395317608	
	300	115	1	1	4932343745	4002395317615	④
④ SDS-Max tile removal chisel	300	80	1	1	4932399234	4002395358489	④
⑤ SDS-Max chasing gouge chisel	300	26	1	1	4932343740	4002395317561	⑤
⑥ SDS-Max chasing wing chisel	380	35	1	1	4932343746	4002395317622	⑥
⑦ SDS-Max spade chisel	400	110	1	1	4932343747	4002395317639	⑦
⑧ SDS-Max surface treatment / bushing tool	240	50	1	1	4932352918	4002395375769	⑧
⑨ SDS-Max electrode / ground rod driver	220	∅ 13.3	1	1	4932451354	4002395159031	⑨
	220	∅ 16.6	1	1	4932451355	4002395159048	
	220	∅ 22.2	1	1	4932451356	4002395159055	
⑩ SDS-Max mortar chisel	280	38	1	1	4932472031	4058546324278	⑩

Universal taper shanks

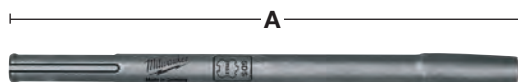

Description	Total length (mm) A	Pack quantity	Min. order quantity	Article Number	EAN Code
Universal taper shank SDS-Max	300	1	1	4932343771	4002395317745

21 mm Hex chisels

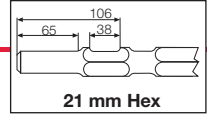

Description	Total length (mm)	Blade width (mm)	Pack quantity	Min. order quantity	Article Number	EAN Code
	380	-	1	1	4932479212	4058546370060
① 21 mm Hex pointed chisel	460	-	1	1	4932492776	4058546476472
	600	-	1	1	4932479213	4058546370077
	380	24	1	1	4932479214	4058546370084
② 21 mm Hex flat chisel	460	25	1	1	4932492777	4058546476489
	600	24	1	1	4932479215	4058546370091
	300	50	1	1	4932479216	4058546370107
③ 21 mm Hex flat wide chisel	300	75	1	1	4932479217	4058546370114
	450	100	1	1	4932479218	4058546370121
④ 21 mm Hex spade chisel	300	-	1	1	4932479219	4058546370138
⑤ 21 mm Hex toolholder	120	120	1	1	4932479220	4058546370145
⑥ 21 mm Hex tamping plate						





28 mm Hex chisels

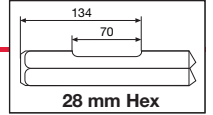

Description	Total length (mm)	Blade width (mm)	Pack quantity	Min. order quantity	Article Number	EAN Code
① 28 mm Hex pointed chisel	400	-	1	1	4932459774	4058546029463
② 28 mm Hex flat chisel	400	35	1	1	4932459775	4058546029470
③ 28 mm Hex flat wide chisel	400	80	1	1	4932459776	4058546029487
④ 28 mm Hex spade chisel	400	125	1	1	4932479221	4058546370152
⑤ 28 mm Hex asphalt cutter	440	115	1	1	4932479222	4058546370169
⑥ 28 mm Hex toolholder	390	-	1	1	4932479223	4058546370176
⑦ 28 mm Hex tamping plate	200	200	1	1	4932479224	4058546370183

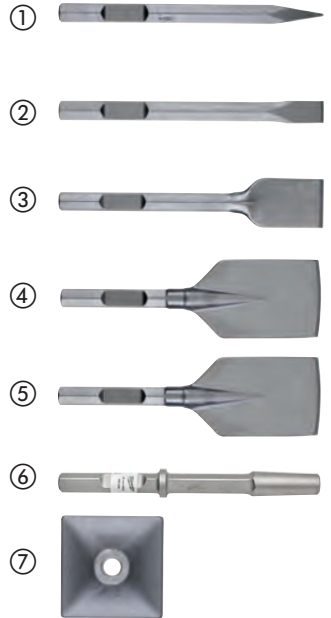



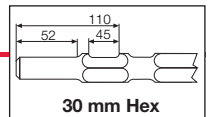

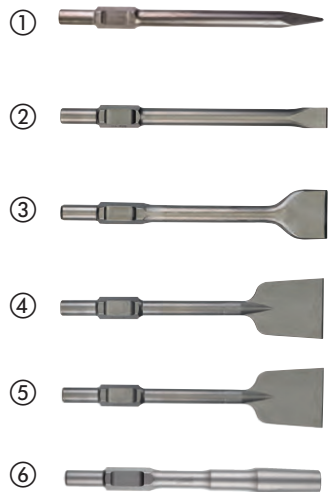

30 mm Hex chisels



Description	Total length (mm)	Blade width (mm)	Pack quantity	Min. order quantity	Article Number	EAN Code
① 30 mm Hex pointed chisel	400	-	1	1	4932464162	4058546221072
② 30 mm Hex flat chisel	400	32	1	1	4932464163	4058546221089
③ 30 mm Hex flat wide chisel	400	75	1	1	4932479225	4058546370190
④ 30 mm Hex spade chisel	400	125	1	1	4932479244	4058546370381
⑤ 30 mm Hex asphalt cutter	400	115	1	1	4932479245	4058546370398
⑥ 30 mm Hex toolholder	360	-	1	1	4932479226	4058546370206

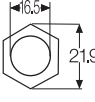
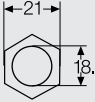

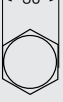
Name		Top view	Suitable for
① SDS-plus	drill		AEG, MILWAUKEE®, Bosch, Dewalt, Hilti, Hitachi, Kango, Makita, Ryobi
① SDS-plus	chisel		AEG, MILWAUKEE®, Bosch, Dewalt, Hilti, Hitachi, Kango, Makita, Ryobi
② SDS-Max	drill		AEG, MILWAUKEE®, Bosch, Dewalt, Hilti, Hitachi, Kango, Makita, Ryobi
② SDS-Max	chisel		AEG, MILWAUKEE®, Bosch, Dewalt, Hilti, Hitachi, Kango, Makita, Ryobi
③ 21 mm Hexagon	drill		Hitachi, Kango, Makita, MILWAUKEE®
④ 21 mm Hexagon	chisel		Hitachi, Kango, Makita, MILWAUKEE®
⑤ 28 mm Hexagon	chisel		AEG, MILWAUKEE®
⑥ 30 mm Hexagon	chisel		Atlas Copco, Kango, MILWAUKEE®

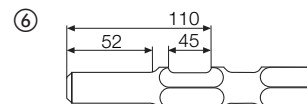
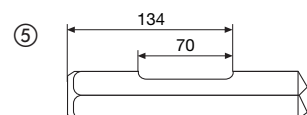
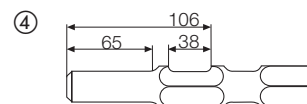
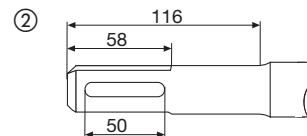
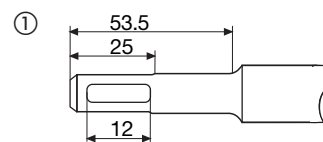



Nothing but **HEAVY DUTY.**[™]

2 CUTTER CARBIDE TIP



- Allows drilling into concrete, bricks, roof tiles, cinderblocks, thin metal, ceramic, tiles, wood, PVC, aluminium, drywall, mortar and plywood
- Very popular drill bits for plumbers because of the versatility

WHITE FLUTE



- To identify the drill bit easily in the users toolbox
- First to market with a white flute

HEX SHANK



- To use with an impact driver and all types of 3 jaw chucks tool like a (percussion) drill driver
- Ensures a safe grip also in standard 3 jaw chucks



MULTI-MATERIAL DRILL BITS

Our Multi-Material Drill Bits are the most versatile bits, designed to tackle materials such as brick, block, concrete, steel, aluminium, ceramic tile, wood, PVC, and drywall. The aggressive multi-grind carbide tip delivers up to 10x longer life in stacked materials and up to 85% faster drilling speeds in metal. Equipped with a 1/4" hex shank, these general-purpose bits are compatible with impact drivers.



SHOCKWAVE IMPACT DUTY

Multi material drill bits

Impact rated: Designed for use with impact drivers and all types of 3 jaw chuck tools like rotary drill/ drivers and percussion drills.

Hex shank up to 260mm total length, 3 flat shank on 400mm total length drill bits.

Tungsten carbide tipped (TCT) drill bits allow drilling into concrete, bricks, roof tiles, aerated concrete blocks, thin metal, aluminium, soft to medium hardness ceramic tiles, all wood types and PVC.

White flute to identify the drill bit easily in the users tool box.

Diameter (mm)	Total length (mm)	Working length (mm)	Pack quantity	Min. order quantity	Article Number	EAN Code
3	90	45	1	1	4932471091	4058546287191
4	90	45	1	1	4932471092	4058546287207
5	100	50	1	1	4932471093	4058546287214
5.5	100	50	1	1	4932471094	4058546287221
5.5	150	90	1	1	4932471095	4058546287238
6	100	50	1	1	4932471096	4058546287245
6	150	90	1	1	4932471097	4058546287252
6	200	140	1	1	4932471098	4058546287269
6	400	340	1	1	4932471099	4058546287276
6.5	150	100	1	1	4932471100	4058546287283
6.5	200	140	1	1	4932471101	4058546287290
6.5	400	340	1	1	4932471102	4058546287306
7	100	50	1	1	4932471103	4058546287313
8	120	60	1	1	4932471104	4058546287320
8	260	200	1	1	4932471105	4058546287337
8	400	340	1	1	4932471106	4058546287344
10	120	60	1	1	4932471107	4058546287351
10	260	200	1	1	4932471108	4058546287368
10	400	340	1	1	4932471109	4058546287375
12	150	90	1	1	4932471110	4058546287382
12	260	260	1	1	4932471111	4058546287399
Multi material drill bit set (8pc)						
Ø 4 x 90 mm, Ø 5 / 5 / 6 / 6 x 100 mm, Ø 8 / 10 x 120 mm, Ø 12 x 150 mm			8	6	4932471112	4058546287405
Multi material drill bit set (8pc)						
Ø 4 x 90mm, Ø 5 / 5.5 / 5.5 x 100mm, Ø 6 / 7 x 100mm, Ø 8 / 10 x 120mm			8	6	4932471113	4058546287412



Premium concrete drill bits - 3 flat shank

Tungsten carbide tipped (TCT) drill bits allow drilling into concrete, aerated concrete blocks, masonry, slate and granite.

From Ø 5 mm the hammer drill bits are supplied with a 3 flat shank to prevent the drill bit slipping in the chuck.

Ø 3 & 4 mm the drill bits are supplied with a round shank.

Red flute to identify the drill bit easily in the users tool box.

Can be used in hammer and rotary mode.

Diameter (mm)	Total length (mm)	Working length (mm)	Pack quantity	Min. order quantity	Article Number	EAN Code
3	90	45	1	1	4932471167	4058546287955
4	90	45	1	1	4932471169	4058546287979
5	100	50	1	1	4932471171	4058546287993
5.5	100	50	1	1	4932471173	4058546288013
6	100	50	1	1	4932471175	4058546288037
6	150	90	1	1	4932471176	4058546288044
6.5	100	50	1	1	4932471178	4058546288068
6.5	150	90	1	1	4932471179	4058546288075
7	100	50	1	1	4932471180	4058546288082
7	150	90	1	1	4932471181	4058546288099
8	100	50	1	1	4932471182	4058546288105
8	150	90	1	1	4932471183	4058546288112
10	150	90	1	1	4932471186	4058546288143
10	260	200	1	1	4932471187	4058546288150
12	150	90	1	1	4932471188	4058546288167
12	260	200	1	1	4932471189	4058546288174
14	150	90	1	1	4932471190	4058546288181
14	260	200	1	1	4932471191	4058546288198
Premium concrete drill bit set (8pc)						
Ø 4 x 90 mm, Ø 5 / 5.5 / 5.5 / 6 / 7 x 100 mm, Ø 8 / 10 x 150 mm			8	6	4932471193	4058546288211
Premium concrete drill bit set (8pc)						
Ø 4 x 90 mm, Ø 5 / 5 / 6 / 6 x 100 mm, Ø 8 / 10 / 12 x 150 mm			8	6	4932471192	4058546288204



Glass & tile bits

Suitable for drilling in non toughened glass, soft to medium hardness tiles and ceramics.

Sharpened carbide for faster drilling.

Reinforced carbide head for increased durability.

Red painted tip.

From Ø 5 mm the glass & tile drill bits are supplied with a multi-flat shank to prevent the drill bit slipping in the chuck.

Diameter (mm)	Pack quantity	Min. order quantity	Article Number	EAN Code	
3	1	1	4932471955	4058546298548	
4	1	1	4932471956	4058546298555	
5	1	1	4932471957	4058546298562	
5.5	1	1	4932471855	4058546297541	
6	1	1	4932471958	4058546298579	
6.5	1	1	4932471856	4058546297558	
7	1	1	4932471857	4058546297565	
8	1	1	4932471959	4058546298586	
10	1	1	4932471960	4058546298593	
12	1	1	4932471961	4058546298609	
14	1	1	4932471858	4058546297572	
16	1	1	4932471859	4058546297589	
Glass & Tile Drill Set - 5pc					
Ø 4 / 5 / 2 x 6 / 8		5	12	4932479948	4058546377427



Concrete drill bits - round shank

Diamond ground percussion carbide tip with two cutting edges.

For drilling in brick, tile, ceramic, concrete, plaster, slate and aerated concrete blocks.

From Ø13 mm the drill bits are supplied with a multi-flat shank to prevent the drill bits slipping in the chuck.

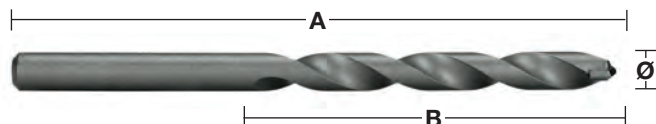

Diameter (mm)	Total length (mm) A	Working length (mm) B	Pack quantity	Min. order quantity	Article Number	EAN Code
3	70	40	1	1	4932363630	4002395332007
3.5	80	45	1	1	4932399916	4002395365746
4	85	50	1	1	4932363631	4002395332014
4.5	85	50	1	1	4932363632	4002395332021
5	85	50	1	1	4932363633	4002395332038
5	150	90	1	1	4932363634	4002395332045
5.5	85	50	1	1	4932363635	4002395332052
5.5	150	90	1	1	4932367035	4002395333998
6	100	60	1	1	4932363636	4002395332069
6	150	90	1	1	4932363637	4002395332076
6	600	550	1	1	4932352506	4002395371648
6.5	100	60	1	1	4932363638	4002395332083
6.5	150	90	1	1	4932367036	4002395334605
7	100	60	1	1	4932363639	4002395332090
7	150	90	1	1	4932367037	4002395334612
7.5	100	60	1	1	4932399917	4002395365753
8	120	80	1	1	4932363640	4002395332106
8	200	150	1	1	4932363641	4002395332113
8	400	350	1	1	4932399384	4002395360017
8	600	550	1	1	4932352507	4002395371655
8.5	120	80	1	1	4932363642	4002395332120
9	120	80	1	1	4932363643	4002395332137
9.5	120	80	1	1	4932399919	4002395365777
10	120	80	1	1	4932363644	4002395332144
10	200	150	1	1	4932363645	4002395332151
11	150	85	1	1	4932363646	4002395332168
12	150	85	1	1	4932363647	4002395332175
12	200	150	1	1	4932363648	4002395332182
12	600	550	1	1	4932352510	4002395371686
13	150	90	1	1	4932363649	4002395332199
13	400	350	1	1	4932352512	4002395371709
14	150	90	1	1	4932363650	4002395332205
14	600	550	1	1	4932352513	4002395371716
16	160	100	1	1	4932373914	4002395353446
16	400	350	1	1	4932399388	4002395360055
18	400	350	1	1	4932352515	4002395371730
20	160	100	1	1	4932399230	4002395358441
20	400	350	1	1	4932399389	4002395360062

① Concrete drill bits set (5pc)

Ø 4 / 5 / 6 / 8 / 10 mm 5 1 4932480157 4058546404420

② Concrete drill bits set (8pc)

Ø 3 / 4 / 5 / 6 / 7 / 8 / 9 / 10 mm 8 1 4932480158 4058546404437

①



②



Impact rated wood auger bits

Suitable for use with all types of corded / cordless drills including impact wrenches. Drilling with an impact wrench enables drilling holes with less effort, one hand drilling, drilling up a ladder and above head height with less risk of injury from the tool clutching out.

Special zone hardening process ensures an extra hard shank, durable tip and perfectly flexible bit body.

New MILWAUKEE® Through-Center head geometry with the lead cutting edge lines up with the center of the feed screw - this ensures efficient chip removal and allows for continuous feeding.

20° rake angle of the lead cutting edge creates a path for easy chip ejection.

Polished and powder coated flute design produces a non-stick surface for increased chip ejection, reduced chip clogging and higher selffeeding capability.

Milling marks are removed in the finishing process, creating a smooth surface.

Lewis flute with large, wide throat design for rapid chip removal.

Sharp ground cutting lips for smooth clean holes.

Resharpenable cutting lips.

With 7/16" shank - to fit square drive 1/2" impact wrenches the adaptor 48660061 is required.

Suitable for hard & soft wood, wet & treated wood, plywood, chipboard, WPC (wood plastic composite), laminated beams and panels, exotic and hard woods e.g. bongossi, iroko, teak, beech, oak, etc.



Impact wood auger bits - short series

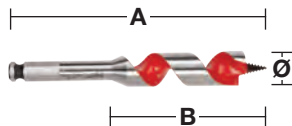

Special short design enables drilling in tight and normally non accessible places.

Diameter (mm)	Total length (mm) A	Working length (mm) B	Shank reception	Pack quantity	Min. order quantity	Article Number	EAN Code
18	153	100	7/16" Hex	1	1	48130683	045242091379
20	153	100	7/16" Hex	1	1	48130813	045242091522
22	153	100	7/16" Hex	1	1	48130873	045242091638
25	153	100	7/16" Hex	1	1	48131003	045242091782
28	153	100	7/16" Hex	1	1	48131123	045242091935
32	153	100	7/16" Hex	1	1	48131253	045242092031

Impact wood auger bits - long series

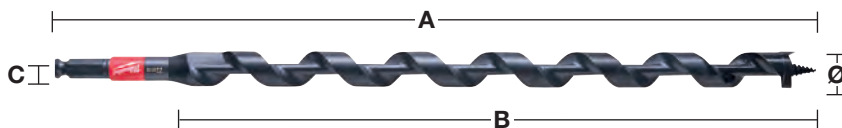

Diameter (mm)	Total length (mm) A	Working length (mm) B	Shank reception	Pack quantity	Min. order quantity	Article Number	EAN Code
14	460	395	7/16" Hex	1	1	48136754	045242518999
16	460	395	7/16" Hex	1	1	48136756	045242519002
18	460	395	7/16" Hex	1	1	48136758	045242500994
19	460	395	7/16" Hex	1	1	48136759	045242519019
20	460	395	7/16" Hex	1	1	48136760	045242501007
22	460	395	7/16" Hex	1	1	48136762	045242519033
26	460	395	7/16" Hex	1	1	48136766	045242501014
29	460	395	7/16" Hex	1	1	48136769	045242519057

Impact wood auger bit set (4pc) available in a pouch

Ø 14 / 16 / 18 / 20 x 460 mm

4 1 48136780 045242005383

Impact wood auger and selffeed bits - adaptor

Description	Pack quantity	Min. order quantity	Article Number	EAN Code
Socket adaptor: 1/2" square to 7/16" and 11 mm Hex. For 7/16" selffeed bits and impact auger bits	1	1	48660061	045242155118





WOOD DRILLING SPEEDS

The following table give recommended drilling speeds for the most efficient cutting speed. The table should only be used as a guide and are dependant on the user and material being drilled.



Forstner bits / Selffeed bits

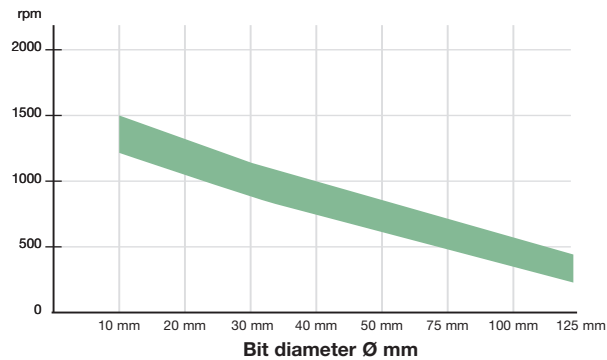

Auger bits

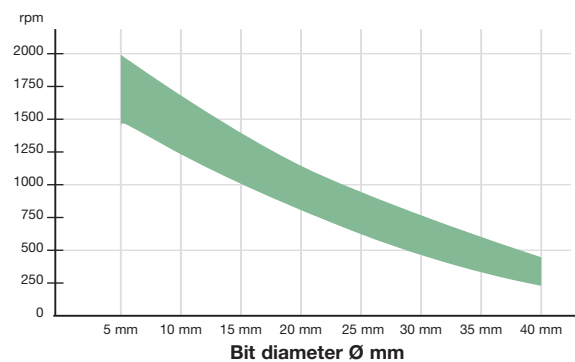

Wood auger bits

For heavy duty, precision drilling in soft and hard wood, large section beams, joists, floor boarding, chipboard and plywood.
Lewis flute design for rapid chip removal.
With Hex shank for secure chuck grip.

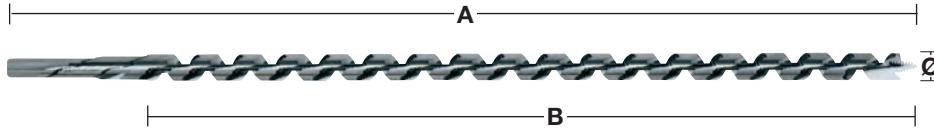

Diameter (mm)	Total length (mm) A	Working length (mm) B	Shank reception	Pack quantity	Min. order quantity	Article Number	EAN Code
6	230	155	6.5 mm Hex	1	1	4932430175	4002395378364
6	460	385	6.5 mm Hex	1	1	4932430176	4002395378371
8	230	155	6.5 mm Hex	1	1	4932363681	4002395331796
8	460	385	6.5 mm Hex	1	1	4932363688	4002395331710
10	230	155	8.5 mm Hex	1	1	4932363682	4002395331802
10	460	385	8.5 mm Hex	1	1	4932363689	4002395331727
10	600	530	8.5 mm Hex	1	1	4932363696	4002395331642
12	230	155	10 mm Hex	1	1	4932363683	4002395331819
12	460	385	10 mm Hex	1	1	4932363690	4002395331734
12	600	530	10 mm Hex	1	1	4932363697	4002395331659
14	230	155	11 mm Hex	1	1	4932363684	4002395331826
14	460	385	11 mm Hex	1	1	4932363691	4002395331741
14	600	530	11 mm Hex	1	1	4932363698	4002395331666
16	230	155	11 mm Hex	1	1	4932363685	4002395331833
16	460	385	11 mm Hex	1	1	4932363692	4002395331758
16	600	530	11 mm Hex	1	1	4932363699	4002395331673
18	230	155	11 mm Hex	1	1	4932363686	4002395331840
18	460	385	11 mm Hex	1	1	4932363693	4002395331765
18	600	530	11 mm Hex	1	1	4932363700	4002395331680
20	230	155	11 mm Hex	1	1	4932363687	4002395331857
20	460	385	11 mm Hex	1	1	4932363694	4002395331772
20	600	530	11 mm Hex	1	1	4932363701	4002395331697
22	230	155	11 mm Hex	1	1	4932373363	4002395347889
22	460	385	11 mm Hex	1	1	4932363695	4002395331789
22	600	530	11 mm Hex	1	1	4932363702	4002395331703
24	230	155	11 mm Hex	1	1	4932373364	4002395347896
24	460	385	11 mm Hex	1	1	4932373370	4002395348558
26	230	155	11 mm Hex	1	1	4932373365	4002395348503
26	460	385	11 mm Hex	1	1	4932373371	4002395348565
28	230	155	11 mm Hex	1	1	4932373366	4002395348510
28	460	385	11 mm Hex	1	1	4932373372	4002395348572
30	230	155	11 mm Hex	1	1	4932373367	4002395348527
30	460	385	11 mm Hex	1	1	4932373373	4002395348589
32	230	155	11 mm Hex	1	1	4932373368	4002395348534
32	460	385	11 mm Hex	1	1	4932373374	4002395348596
① Wood auger bits set (6pc) Ø 8 / 10 / 12 / 14 / 16 / 18 mm x 230 mm			Wood case	6	1	4932373380	4002395349258

Forstner bits

Centre point for precisely locating the bit. Peripheral cutters ensure splinter free drilling in all natural soft and hard woods. Manufactured according to DIN 74836. Suitable for heavy-duty applications in all natural, soft and hard woods.

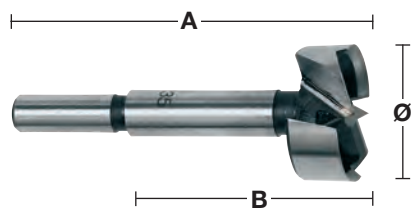

Diameter (mm)	Total length (mm) A	Working length (mm) B	Shank reception	Pack quantity	Min. order quantity	Article Number	EAN Code
10	90	50	9.5 mm round shank	1	1	4932363703	4002395331468
12	90	50	9.5 mm round shank	1	1	4932363704	4002395331475
14	90	50	9.5 mm round shank	1	1	4932363705	4002395331482
15	90	50	9.5 mm round shank	1	1	4932363883	4002395333738
16	90	50	9.5 mm round shank	1	1	4932363706	4002395331499
18	90	50	9.5 mm round shank	1	1	4932363707	4002395331505
20	90	50	9.5 mm round shank	1	1	4932363708	4002395331512
25	90	50	9.5 mm round shank	1	1	4932363711	4002395331543
26	90	50	9.5 mm round shank	1	1	4932363712	4002395331550
30	90	50	9.5 mm round shank	1	1	4932363714	4002395331574
32	90	50	9.5 mm round shank	1	1	4932363715	4002395331581
35	90	50	9.5 mm round shank	1	1	4932363717	4002395331604
40	90	50	9.5 mm round shank	1	1	4932363720	4002395331635
50	90	50	9.5 mm round shank	1	1	4932373923	4002395353538
Forstner drill bits set (5pc)							
①	Ø 15 / 20 / 25 / 30 / 35 mm			5	1	4932373379	4002395349241

SWITCHBLADE™ selffeed bits

Speed: Aggressive feed screw design allows the bit to pull through the wood faster and without effort, resulting in faster drilling.

Replaceable SWITCHBLADE™: The SWITCHBLADE™ replaceable blade system ensures your blade is always razor sharp. It increases productivity by eliminating resharpening downtime and it increases the overall life of the bit.

Application: Suitable for all general contractors, electricians, plumbers and HVAC engineers who require to drill through holes in wood for all types of pipe, vents and wire trunking.

Each selffeed bit is supplied with 1x blade, 2x replaceable feed screws, 1x set screws and 1x allen key.



Diameter (mm)	Shank reception	Pack quantity	Min. order quantity	Article Number	EAN Code
35	7/16" Hex	1	1	4932479497	4058546372910
38	7/16" Hex	1	1	4932479498	4058546372927
51	7/16" Hex	1	1	4932479499	4058546372934
54	7/16" Hex	1	1	4932479500	4058546372941
57	7/16" Hex	1	1	4932479501	4058546372958
65	7/16" Hex	1	1	4932479502	4058546372965

SWITCHBLADE™ set

Description	Pack quantity	Min. order quantity	Article Number	EAN Code
SWITCHBLADE™ selffeed bits set (5pc) 4 x SWITCHBLADE™ selffeed bits: Ø 35 / 38 / 54 / 65 mm, QUIK-LOK extension 140 mm length, 4 x Replacement SWITCHBLADE™ blades (1 for each size bit), 4 x feed screws, 4 x set screws, 1 x allen key	5	1	4932479503	4058546372972



SWITCHBLADE™ replacement blades

Diameter (mm)	Pack quantity	Min. order quantity	Article Number	EAN Code
35	1	1	4932479546	4058546373405
38	1	1	4932479547	4058546373412
51	1	1	4932479548	4058546373429
54	1	1	4932479549	4058546373436
57	1	1	4932479550	4058546373443
65	1	1	4932479551	4058546373450



SWITCHBLADE™ service kit in storage container

1x feed screw, 2x set screws, 1x allen key, 1x storage container also can store spare SWITCHBLADE™	5	1	4932479552	4058546373467
---	---	---	------------	---------------

SHOCKWAVE IMPACT DUTY TM

Selffeed bits

All sizes have removable and replaceable feed screws.
 Two feed screws supplied with each bit.
 Feed screw provides fast, effortless feeding even in gummy woods.
 Internal cutting plane shaves hole radius for clean, smooth holes without pressure.
 Each selffeed bit is supplied with 2 x feed screws, 1 x set screw and 1 x allen key.

Diameter (mm)	Shank reception	Pack quantity	Min. order quantity	Article Number	EAN Code
25	7/16" Hex	1	1	4932479478	4058546372729
29	7/16" Hex	1	1	4932479479	4058546372736
32	7/16" Hex	1	1	4932479480	4058546372743
35	7/16" Hex	1	1	4932479481	4058546372750
38	7/16" Hex	1	1	4932479482	4058546372767
44	7/16" Hex	1	1	4932479483	4058546372774
51	7/16" Hex	1	1	4932479484	4058546372781
54	7/16" Hex	1	1	4932479485	4058546372798
57	7/16" Hex	1	1	4932479486	4058546372804
65	7/16" Hex	1	1	4932479487	4058546372811
Feed screw coarse thread 1/4"		1	1	48286870	045242122707
Hex key 1/8" for all arbors		1	1	49960060	045242221455
Set screw for drills up to 65 mm		1	1	06832625	-



Large selffeed bits

Large selffeed bits in 76, 92 and 116 mm sizes have double internal cutter blades that shave hole radius for clean, smooth holes without pressure.
 Replaceable arbor.

Diameter (mm)	Shank reception	Pack quantity	Min. order quantity	Article Number	EAN Code
76	7/16" Hex	1	1	4932479489	4058546372835
92	7/16" Hex	1	1	4932479490	4058546372842
116	7/16" Hex	1	1	4932479491	4058546372859
Replaceable arbor		1	1	48070201	045242088904
Feed screw regular thread		1	1	48286880	045242122806
Set screw for drills up over 76mm		1	1	06833150	4058546040864
Allen key 5/32"		1	1	49960070	045242221554



Selffeed bits contractors kit

Description	Pack quantity	Min. order quantity	Article Number	EAN Code
Selffeed bit contractors kit (8pc)				
Selffeed bits Ø 25 / 29 / 32 / 38 / 44 / 54 / 65 mm, extension 140 mm length and feed screws	8	1	4932479488	4058546372828



Shank extensions

For selffeed bits, auger bits and holesaws (25 mm / 1" diameter and larger) with 7/16" Hex shank

Total length (mm) A	Pack quantity	Min. order quantity	Article Number	EAN Code
140	1	1	4932479493	4058546372873
300	1	1	4932479494	4058546372880
450	1	1	4932479495	4058546372897
600	1	1	4932479496	4058546372903

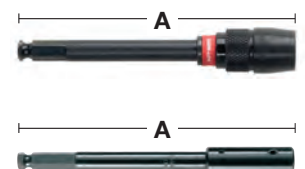

Lip & spur / brad point bits for wood - DIN 7487 E

Suitable for drilling hardboard, plywood, chipboard and all natural hard and soft wood.
Produced according to DIN 7487 E.

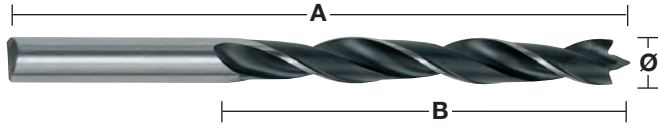

Diameter (mm)	Total length (mm) A	Working length (mm) B	Shank reception	Pack quantity	Min. order quantity	Article Number	EAN Code
3	60	33	3 mm round shank	1	1	4932363651	4002395331307
4	75	43	4 mm round shank	1	1	4932363652	4002395331314
5	86	52	5 mm round shank	1	1	4932363653	4002395331321
6	97	60	6 mm round shank	1	1	4932363654	4002395331338
7	109	69	7 mm round shank	1	1	4932363655	4002395331345
8	117	75	8 mm round shank	1	1	4932363656	4002395331352
9	125	80	9 mm round shank	1	1	4932363657	4002395331369
10	133	87	10 mm round shank	1	1	4932363658	4002395331376
11	142	89	10 mm round shank	1	1	4932363659	4002395331383
12	151	96	10 mm round shank	1	1	4932363660	4002395331390
13	151	96	10 mm round shank	1	1	4932363661	4002395331406
14	151	97	10 mm round shank	1	1	4932363662	4002395331413
15	151	97	10 mm round shank	1	1	4932363663	4002395331420
16	151	97	10 mm round shank	1	1	4932363664	4002395331437
18	180	120	10 mm round shank	1	1	4932363665	4002395331444
20	200	130	10 mm round shank	1	1	4932363666	4002395331451
① Wood drill bit set (5pc) Ø 4 / 5 / 6 / 8 / 10 mm			Plastic cassette	5	1	4932352465	4002395371242
② Wood drill bit set (8pc) Ø 3 / 4 / 5 / 6 / 7 / 8 / 9 / 10 mm			Plastic cassette	8	1	4932352466	4002395371259

Flat boring bits

Fast drilling of big diameters.

Suitable for drilling in natural hard and softwood and chipboard.

Ideal for door locks, morticing, electrical and plumbing work.

1/4" Hex shank reception (DIN E 6.3) for direct insertion into the power tool or for secure chuck grip.

Ground centre point for accurate positioning and sharp wings (not applicable to 6 & 8 mm) for improved cutting performance.

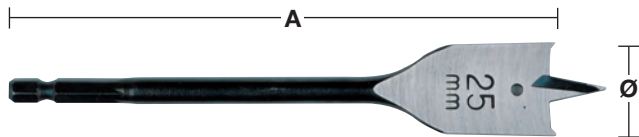

①

Diameter (mm)	Total length (mm) A	Pack quantity	Min. order quantity	Article Number	EAN Code
6	152	1	1	4932352487	4002395371457
6	400	1	1	4932352488	4002395371464
8	152	1	1	4932363130	4002395332618
8	400	1	1	4932352489	4002395371471
10	152	1	1	4932363131	4002395332625
10	400	1	1	4932352490	4002395371488
12	152	1	1	4932363132	4002395332632
12	400	1	1	4932352491	4002395371495
13	152	1	1	4932363133	4002395332649
13	400	1	1	4932352492	4002395371501
14	152	1	1	4932363134	4002395332656
14	400	1	1	4932352493	4002395371518
16	152	1	1	4932363135	4002395332663
16	400	1	1	4932352494	4002395371525
18	152	1	1	4932363136	4002395332670
18	400	1	1	4932352495	4002395371532
19	152	1	1	4932363137	4002395332687
19	400	1	1	4932352496	4002395371549
20	152	1	1	4932363138	4002395332694
20	400	1	1	4932352497	4002395371556
22	152	1	1	4932363139	4002395332700
22	400	1	1	4932352498	4002395371563
24	152	1	1	4932363140	4002395332717
25	152	1	1	4932363141	4002395332724
25	400	1	1	4932352499	4002395371570
26	152	1	1	4932363142	4002395332731
28	152	1	1	4932363143	4002395332748
28	400	1	1	4932352500	4002395371587
30	152	1	1	4932363144	4002395332755
30	400	1	1	4932352501	4002395371594
32	152	1	1	4932363145	4002395332762
32	400	1	1	4932352502	4002395371600
35	400	1	1	4932352503	4002395371617
36	152	1	1	4932363146	4002395332779
38	152	1	1	4932363147	4002395332786
40	152	1	1	4932479227	4058546370213
① Flat bit set (8pc) Ø 12 / 16 / 18 / 20 / 22 / 25 / 28 / 32 x 152 mm length		8	1	4932352504	4002395371624

Extension



Description	Total length (mm) A	Shank reception	Tool reception	Pack quantity	Min. order quantity	Article Number	EAN Code
Extension	305	1/4" Hex	1/4" Hex	1	1	4932363148	4002395332793

SPEED FEED[™] wood drill bits

Step up from flat bit in quality and performance - faster drilling, higher lifetime and less jamming!

Dual cutting edges for fast and aggressive cut - up to 10 times faster drilling vs. flat boring bit.

Tapered design for reduced chip clogging, less friction and less jamming even in tough applications - results in less breakages.

Feed screw with coarse thread increases selffeeding in all types of wood - soft & hard, wet & treated.

Polished and powder coated flute design for increased chip ejection, reduced clogging and higher selffeeding capability.

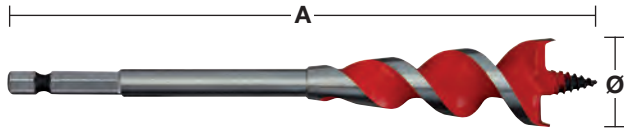

Dual cutting edges

Diameter (mm)	Ø (inch)	Total length (mm) A	Shank reception	Pack quantity	Min. order quantity	Article Number	EAN Code
13	1/2"	165	1/4" Hex	1	1	4932479471	4058546372651
16	5/8"	165	1/4" Hex	1	1	4932479472	4058546372668
18	3/4"	165	1/4" Hex	1	1	4932464071	4058546220167
20	3/4"	165	1/4" Hex	1	1	4932479473	4058546372675
22	7/8"	165	1/4" Hex	1	1	4932479474	4058546372682
25	1"	165	1/4" Hex	1	1	4932479475	4058546372699
32	1 1/4"	165	1/4" Hex	1	1	4932479476	4058546372705
SPEED FEED[™] set (4pc)				4	1	4932479477	4058546372712
Ø 13 / 16 / 20 / 25 mm							



Tapered design

HSS cable bits - DIN 7490

Manufactured from HSS steel for increased lifetime. Suitable for drilling through holes in wood, plasterboard and metal channel.





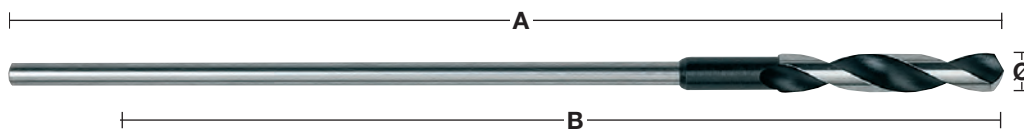

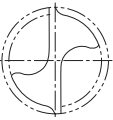
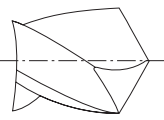
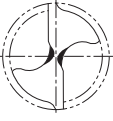
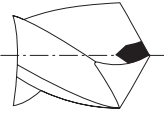

Manufactured according to DIN 7490 and conforming to the German Employer's Liability Insurance Association in terms of safety requirements for the building trade. The body of the drill bit is attached to the cylindrical shank by means of a thread, therefore eliminating the risk of breakage and guaranteeing absolute concentricity. The small twist angle and enlarged flutes ensure rapid and clog-free chip removal.

Made in Germany.

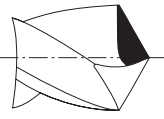

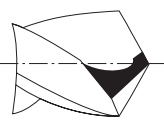
Diameter (mm)	Total length (mm) A	Working length (mm) B	Shank reception	Pack quantity	Min. order quantity	Article Number	EAN Code
6	400	300	5 mm round shank	1	1	4932399672	4002395363223
6	600	500	5 mm round shank	1	1	4932399675	4002395363254
8	400	300	6 mm round shank	1	1	4932363667	4002395331932
8	600	500	6 mm round shank	1	1	4932363674	4002395331864
10	400	300	8 mm round shank	1	1	4932363668	4002395331949
10	600	500	8 mm round shank	1	1	4932363675	4002395331871
12	400	300	8 mm round shank	1	1	4932363669	4002395331956
12	600	500	8 mm round shank	1	1	4932363676	4002395331888
14	400	300	8 mm round shank	1	1	4932363670	4002395331963
14	600	500	8 mm round shank	1	1	4932363677	4002395331895
16	400	300	10 mm round shank	1	1	4932363671	4002395331970
16	600	500	10 mm round shank	1	1	4932363678	4002395331901
18	400	300	10 mm round shank	1	1	4932363672	4002395331987
18	600	500	10 mm round shank	1	1	4932363679	4002395331918
20	400	300	10 mm round shank	1	1	4932363673	4002395331994
20	600	500	10 mm round shank	1	1	4932363680	4002395331925
22	400	300	10 mm round shank	1	1	4932399673	4002395363230
22	600	500	10 mm round shank	1	1	4932399676	4002395363261

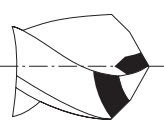
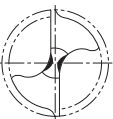
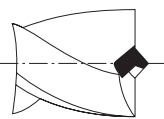
HSS Drill bit tip geometry

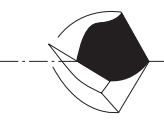
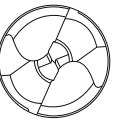
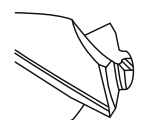
		Standard/Form	Application	Features
		Normal Standard Point	For standard drilling in ferrous/non ferrous metals and plastics	The wide cutting edge provides a drill bit that is robust and resistant to sideways pressure. Due to the wide cutting edge higher feed pressure is required. Can be easily resharpened.
		Chisel Edge Point DIN 1412 A	For drilling work in solid steel with large diameter drill bits.	Good and easy centering. Requires very low feed pressure – approx. 30% less than a normal point drill bit.
		Chisel Edge Point with corrected cutting edge DIN 1412 B	For drilling in high strength steel and high alloy steels. Also suitable for drilling thin sheet material.	Robust and resistant to sideways pressure.
		Split Point DIN 1412 C	For drilling in high strength steel and high alloy steels. Suitable for deep drilling bits.	Excellent chip removal makes this design ideal for deep drilling applications. Good centering. Low feed pressure required.
		Double Angle Point for Cast Iron DIN 1412 D	For drilling cast iron.	Extended major cutting edges reduce wear on the cutting corners for improved lifetime. Good heat conduction. Resistant to sideways pressure.
		Centre Point DIN 1412 E	For drilling thin sheet metal and soft materials.	Easy centering. Low feed pressure required. Does not snatch when drilling thin materials. Accurate and clean holes.
		U Point	For high performance drilling in high strength steels such as stainless and acid resistant steel.	Easy centering. Produces small metal chips ensuring low heat build up and quicker material resulting in faster drilling.
		Quad Edge Tip	For drilling in high strength steel and high alloy steel.	Easy centering and fast drilling start with 135° split point tip. Four cutting edges create smaller chips to prevent heat build up for longer life.

HSS Drill bit application guide

The following table gives recommended drilling speeds for the most efficient cutting speed. The tables should only be used as a guide and are dependant on the user and material being drilled. Coolants and lubricants will improve tool life by up to 5 times and workpiece finish.

Material class		Material type	Hardness/ Tensile Strength N/mm ²	Rockwell	Hole diameter Ø mm – RPM					Cooling agent
					Ø 1–2	Ø 3–5	Ø 6–10	Ø 11–15	Ø 16–20	
Steel	Speed	Non-alloyed construction steel, non-alloyed case hardened steel	< 400	< HRB 69	4770	1870	930	630	470	Drilling emulsion, cutting oil
			400–800	< HRC 21	4450	1770	870	580	430	
		Sheet Steel	< 800	< HRC 21	4450	1760	860	560	430	Drilling emulsion, ester oil
		Non-alloyed tool steel	< 800	< HRC 21	4440	1760	860	560	430	Drilling emulsion, cutting oil
		Alloyed tool steel	< 800	< HRC 21	3950	1550	780	520	390	Drilling emulsion, ester oil
			> 800	> HRC 21	1950	800	390	275	200	
	Alloyed hardened & tempered steel	< 1200	< HRC 37	2100	890	450	300	210	Drilling emulsion, ester oil	
> 1200		> HRC 38	1350	540	260	170	120			
Feed	Feed (mm/rev)				0.03	0.09	0.15	0.20	0.25	
Stainless steel	Speed	Stainless steel	< 1000	< HRC 30	2250	930	450	290	220	Rapeseed oil, cutting oil
		Stainless steel	1000–1200	HRC 30–37	1430	560	280	190	130	
	Feed	Feed (mm/rev)				0.02	0.06	0.13	0.18	0.24
Cast iron	Speed	Malleable cast iron	750	HRB 99	4700	2000	1100	800	600	Dry
		Soft	450	HRB 75	4500	1700	950	650	550	Drilling emulsion, cutting oil
		Hard	700	HRB 96	3450	1350	680	440	340	
	Feed	Feed (mm/rev)				0.05	0.10	0.16	0.20	0.25
Aluminium	Speed		< 350	< HRC 59	8700	3560	1720	1130	860	Drilling emulsion, cutting oil
	Feed	Feed (mm/rev)				0.02	0.08	0.13	0.18	0.23
Copper	Speed				5100	2000	990	670	500	Drilling emulsion, cutting oil
	Feed	Feed (mm/rev)				0.02	0.10	0.20	0.28	0.35
Bronze	Speed				7950	3190	1480	1010	770	Dry
	Feed	Feed (mm/rev)				0.02	0.11	0.21	0.32	0.35
Brass	Speed				7950	3190	1480	1010	770	Drilling emulsion
	Feed	Feed (mm/rev)				0.02	0.11	0.21	0.32	0.35
Magnesium	Speed				9550	3800	1900	1250	970	Dry
	Feed	Feed (mm/rev)				0.05	0.10	0.25	0.30	0.35
Plastics	Speed	PVC, Polyamide, Thermoplastics			3500	2500	1800	700	450	Water
	Feed	Feed (mm/rev)				0.05	0.10	0.16	0.21	0.23

RPM: The number of revolutions that a spindle/a cutting tool completes in one minute.

Feed: This is the linear distance at which the cutter is advanced against the workpiece during one rotation of the cutting tool. It is expressed in units of distance per revolution – millimetres per revolution.

HSS Drill bit application guide

Material class	Material type	Hardness/ Tensile Strength N/mm ²	Rockwell	HSS-R DIN 338	HSS-G Thunderweb DIN 338 DIN 340 DIN 1897 Double Ended	RED COBALT - HSS-Ground - DIN 338	RED HEX - Shockwave HSS- Ground Titanium	Step drills	Shockwave Step drills	Cobalt Step Drills	Cooling agent	
Steel	Non-alloyed construction steel, non-alloyed case hardened steel	< 400	< HRB 69		●	●	●	●	●	●	Drilling emulsion, cutting oil	
		400-800	< HRC 21	●	●	●	●	●	●	●		
	Sheet Steel	< 800	< HRC 21		●	●	●	●	●	●	Drilling emulsion, ester oil	
	Non-alloyed tool steel	< 800	< HRC 21	●	●	●	●	●	●	●	Drilling emulsion, cutting oil	
	Alloyed tool steel	< 800	< HRC 21			●	●	●	●	●	●	Drilling emulsion, ester oil
		> 800	> HRC 21		●	●	●	▲	▲	●		
Alloyed hardened & tempered steel	< 1200	< HRC 37				●	●	▲	▲	▲	Drilling emulsion, ester oil	
	> 1200	> HRC 38				●	●	▲	▲	▲		
Stainless steel	Stainless steel	< 1000	< HRC 30		▲	●	●	▲		●	Rapeseed oil, cutting oil	
	Stainless steel	1000-1200	HRC 30-37			●	●	▲		●		
Cast iron	Malleable cast iron	750	HRB 99	●	●	●	●	●	●	●	Dry	
	Soft	450	HRB 75	●	●	●	●	▲		●	Drilling emulsion, cutting oil	
	Hard	700	HRB 96	●	●	●	●	●	●	●		
Aluminium		< 350	< HRC 59		▲	●	●	●	●	●	Drilling emulsion, cutting oil	
Copper					▲	●	●	●	●	●	Drilling emulsion, cutting oil	
Bronze				●	●	●	●	●	●	●	Dry	
Brass				●	●	●	●	●	●	●	Drilling emulsion	
Magnesium						●	●				Dry	
Plastics	PVC, Polyamide, Thermoplastics				●	●	●	●	●	●	Water	
Wood				●	●	●	●				Dry	

● Most suitable. Recommended for these materials. ▲ Suitable. Recommended for intermittent use in these materials.



Nothing but **HEAVY DUTY**.™

HIGH PERFORMANCE DRILL BITS

RED HEX

HSS-TIN METAL DRILL BITS

SHOCKWAVE
IMPACT DUTY

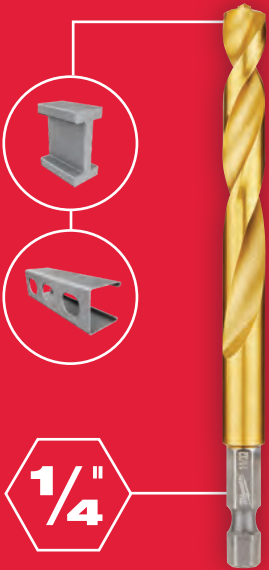

FOR IMPACTS AND DRILLS

RED COBALT

HSS-CO METAL DRILL BITS



3
FLAT



QUAD EDGE™ TIP



VARIABLE FLUTE



ENHANCED TAPERED WEB

RED HEX & RED COBALT SPECIFICATIONS

QUAD EDGE™ TIP

- Unique combination of 135° split point and four cutting edges.
- Allows for precise and fast drilling start without walking.
- Four cutting edges create smaller chips to prevent heat build up to ensure longer life.

VARIABLE FLUTE GEOMETRY

- Faster material ejection.
- Helps the bit run cooler and prevent it from burning out faster.

ENHANCED TAPERED WEB

- Wider core towards the shank of the drill bit.
- Strengthens the core to increase overall flute durability.

Quad Edge™ Tip on sizes > Ø 4.5 mm. 3-Flat on HSS-Co sizes > Ø 5 mm.



SHOCKWAVE IMPACT DUTY™

RED HEX

RED HEX - SHOCKWAVE™ HSS-TiN metal drill bits

Impact rated drill bit with 1/4" hex shank optimised for impact drivers.
Titanium Nitride coating dispenses heat and makes the drill bit suitable for use also in high speed.

Diameter (mm)	Total length (mm) A	Working length (mm) B	Pack quantity	Min. order quantity	Article Number	EAN Code
2	59.5	17	2	1	48894703	045242501557
2.5	62	19	2	1	48894704	045242501564
3	65	23	2	1	48894763	045242506866
3.2	66.5	23	2	1	48894706	045242501571
3.3	67	24	2	1	4932471089	4058546287177
3.5	69	25	2	1	48894707	045242501588
4	71.5	26	2	1	48894708	045242501595
4.2	74	28	1	1	48894709	045242501601
4.5	76	29	1	1	48894710	045242501618
4.8	78	29	1	1	48894711	045242501625
5	80	31	1	1	48894712	045242501632
5.5	104	60	1	1	48894764	045242506873
6	105	63	1	1	48894714	045242501649
6.5	107	64	1	1	48894715	045242501656
6.8	108	65	1	1	48894716	045242501663
7	109	66	1	1	48894717	045242501670
7.5	110	67	1	1	48894718	045242501687
8	111	70	1	1	48894719	045242501694
8.5	114	72	1	1	48894720	045242501700
9	117	73	1	1	48894721	045242501717
9.5	118	74	1	1	48894722	045242501724
10	120	76	1	1	48894723	045242501731
10.2	121	77	1	1	4932471090	4058546287184
10.5	122	78	1	1	48894724	045242501748
11	125	80	1	1	48894725	045242501755
11.5	126	81	1	1	48894726	045242501762
12	127	82	1	1	48894727	045242501779
12.5	128	83	1	1	48894728	045242501786
13	130	83	1	1	48894729	045242501793
SHOCKWAVE™ HSS-G TiN Red Hex drill bits set (10pc)			10	6	48894759	045242502066
Ø 3 / 3.5 / 4 / 4.5 / 5 / 6 / 7 / 8 / 9 / 10 mm						
SHOCKWAVE™ HSS-G TiN Red Hex drill bit set (19pc)			19	6	48894760	045242502073
Ø 2 / 2.5 / 2 x 3 / 3.5 / 2 x 4 / 4.5 / 5 / 5.5 / 6 / 6.5 / 7 / 7.5 / 8 / 8.5 / 9 / 9.5 / 10 mm						

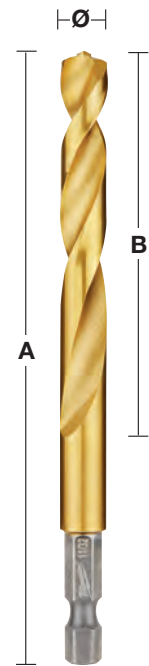

①



②



Diameter (mm)	Total length (mm) A	Working length (mm) B	Pack quantity	Min. order quantity	Article Number	EAN Code
2.5	62	19	10	1	4932478175	4058546341084
3.0	65	23	10	1	4932478176	4058546341091
3.5	69	25	10	1	4932478177	4058546341107
4.0	71.5	26	10	1	4932478178	4058546341114
4.5	76	29	10	1	4932478179	4058546341121
5.0	80	31	10	1	4932478180	4058546341138
6.0	105	63	10	1	4932478181	4058546341145
7.0	109	66	5	1	4932478182	4058546341152
8.0	111	70	5	1	4932478183	4058546341169
10.0	120	76	5	1	4932478184	4058546341176

RED COBALT - HSS-Ground - DIN 338 Cobalt metal drill bits

Metal drill bits ground from solid, extremely heat resistant 5% cobalt-alloyed high speed steel produced according to DIN 338.

Suitable for drilling high alloy content steels and metals with tensile strengths over 1000 N/mm² like stainless steel.

QUAD EDGE™ Tip: unique combination of 135° split point and four cutting edges: 135° split point allows for precise & fast drilling start without walking. Four cutting edges create smaller chips to prevent heat build up for longer life.

Variable flute geometry: For faster material ejection. Helps the bit run cooler and prevent it from burning out faster.

Enhanced tapered web: Wider core towards the shank of the drill bit. Strengthens the core to increase overall flute durability.

3-flat shank from Ø 5 mm for better grip and prevents chuck slippage.

Colour: bronze.

RED COBALT



Diameter (mm)	Total length (mm) A	Working length (mm) B	Pack quantity	Min. order quantity	Article Number	EAN Code
1.0	34	12	2	1	4932363248	4002395333080
1.5	40	18	2	1	4932363249	4002395333097
2.0	49	24	2	1	4932363250	4002395333103
2.5	57	30	2	1	4932363251	4002395333110
3.0	61	33	2	1	4932363253	4002395333134
3.2	65	36	2	1	4932363254	4002395333141
3.3	67	37	2	1	4932471140	4058546287689
3.5	70	39	2	1	4932363256	4002395333165
4.0	75	43	2	1	4932363258	4002395333189
4.2	75	43	1	1	4932363260	4002395333202
4.5	80	47	1	1	4932363262	4002395333226
4.8	86	52	1	1	4932363263	4002395333233
5.0	86	52	1	1	4932363264	4002395333240
5.5	93	57	1	1	4932363267	4002395333271
6.0	93	57	1	1	4932363268	4002395333288
6.5	101	63	1	1	4932363269	4002395333295
6.8	109	69	1	1	4932363270	4002395333301
7.0	109	69	1	1	4932363271	4002395333318
7.5	109	69	1	1	4932363272	4002395333325
8.0	117	75	1	1	4932363274	4002395333349
8.5	117	75	1	1	4932363276	4002395333363
9.0	125	81	1	1	4932363277	4002395333370
9.5	125	81	1	1	4932363278	4002395333387
10.0	133	87	1	1	4932363279	4002395333394
10.2	133	87	1	1	4932471141	4058546287696
10.5	133	87	1	1	4932363281	4002395333417
11.0	142	94	1	1	4932363282	4002395333424
11.5	142	94	1	1	4932363283	4002395333431
12.0	151	101	1	1	4932363284	4002395333448
12.5	151	101	1	1	4932363285	4002395333455
13.0	151	101	1	1	4932363286	4002395333462

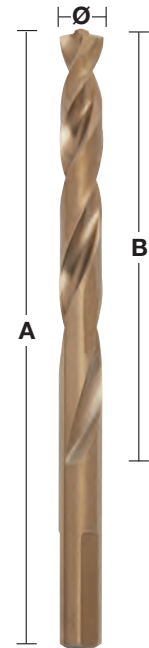

RED COBALT - HSS-Ground - DIN 338 Cobalt metal drill bits - sets

Description	Supplied in	Pack quantity	Min. order quantity	Article Number	EAN Code
RED COBALT HSS-Ground set (19pc)					
① Ø 1/1.5/2/2.5/3/3.5/4/4.5/5/5.5/6/6.5/7/7.5/8/8.5/9/9.5/10 mm	Plastic cassette	19	6	4932352470	4002395371297
RED COBALT HSS-Ground set (25pc)					
② Ø 1/1.5/2/2.5/3/3.5/4/4.5/5/5.5/6/6.5/7/7.5/8/8.5/9/9.5/10/10.5/11/11.5/12/12.5/13 mm	Plastic cassette	25	1	4932352471	4002395371303



RED COBALT - HSS-Ground - DIN 338 Cobalt metal drill bits - 5 and 10 pack

Metal drill bits ground from solid, extremely heat resistant 5% cobalt-alloyed high speed steel produced according to DIN 338.

Suitable for drilling high alloy content steels and metals with tensile strengths over 1000 N/mm² like stainless steel.

QUAD EDGE™ Tip: unique combination of 135° split point and four cutting edges: 135° split point allows for precise & fast drilling start without walking. Four cutting edges create smaller chips to prevent heat build up for longer life.

Variable flute geometry: For faster material ejection. Helps the bit run cooler and prevent it from burning out faster.

Enhanced tapered web: Wider core towards the shank of the drill bit. Strengthens the core to increase overall flute durability.

3-flat shank from Ø 5 mm for better grip and prevents chuck slippage.

RED COBALT



Diameter (mm)	Total length (mm) A	Working length (mm) B	Pack quantity	Min. order quantity	Article Number	EAN Code
1.0	34	12	10	1	4932373332	4002395349173
1.5	40	18	10	1	4932373333	4002395349180
2.0	49	24	10	1	4932373334	4002395349197
2.5	57	30	10	1	4932373335	4002395349807
3.0	61	33	10	1	4932373336	4002395349814
3.2	65	36	10	1	4932373337	4002395349821
3.3	67	37	10	1	4932471142	4058546287702
3.5	70	39	10	1	4932373338	4002395349838
4.0	75	43	10	1	4932373339	4002395349845
4.2	75	43	10	1	4932373340	4002395349852
4.5	80	47	10	1	4932373341	4002395349869
4.8	86	52	10	1	4932373342	4002395349876
5.0	86	52	10	1	4932373343	4002395349883
5.5	93	57	10	1	4932373344	4002395349890
6.0	93	57	10	1	4932373345	4002395347100
6.5	101	63	10	1	4932373346	4002395347117
6.8	109	69	5	1	4932373347	4002395347124
7.0	109	69	5	1	4932373348	4002395347131
7.5	109	69	5	1	4932373349	4002395347148
8.0	117	75	5	1	4932373350	4002395347155
8.5	117	75	5	1	4932373351	4002395347162
9.0	125	81	5	1	4932373352	4002395347179
9.5	125	81	5	1	4932373353	4002395347186
10.0	133	87	5	1	4932373354	4002395347193
10.2	133	87	5	1	4932471143	4058546287719
10.5	133	87	5	1	4932373355	4002395347803
11.0	142	94	5	1	4932373356	4002395347810
11.5	142	94	5	1	4932373357	4002395347827
12.0	151	101	5	1	4932373358	4002395347834
12.5	151	101	5	1	4932373359	4002395347841
13.0	151	101	5	1	4932373360	4002395347858



THUNDERWEB

Metal drill bits HSS Ground - DIN 338



THUNDERWEB

The **THUNDERWEB** design is characterised by a conical shaped web which gets thicker towards the back of the drill bit. The web is the internal core of the drill bit.

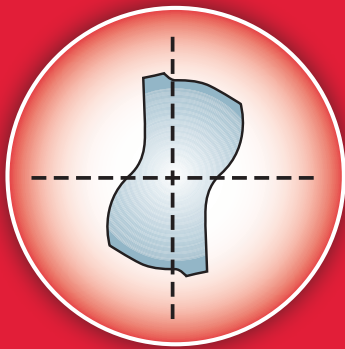

Parabolic web cross section

- Large web thickness. Strength built in.
- Accepts higher feed pressure and torque.
- Less breakages. Good for drilling deep holes and on curved surfaces.
- Long life.

ISO

Standard drill bit

The web on standard drill bits is a constant thickness throughout the length of the bit.

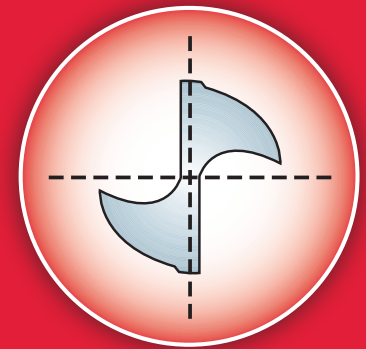

Conventional type web cross section



THUNDERWEB SPECIFICATION

FLUTE GEOMETRY

- **THUNDERWEB** flute form ejects hot chips rapidly. Dissepates heat better increasing lifetime.
- Open flute form reduces drill drawback when drilling deeper holes.
- Sharpened edges reduce binding for faster cleaner cuts.
- Flatter twist angle creates smaller chippings, ideal for drilling harder steels ie. stainless steel.

135° SPLIT POINT

- Precision starting, drill bit won't walk.
- Penetrates quickly.
- Good for drilling on curved surfaces.
- Requires less effort/feed pressure.
- Excellent for very hard materials.



THUNDERWEB - HSS-Ground metal drill bits - DIN338

Diameter (mm)	Total length (mm) A	Working length (mm) B	Pack quantity	Min. order quantity	Article Number	EAN Code
1.0	34	12	2	1	4932352345	4002395370047
1.5	40	18	2	1	4932352346	4002395370054
2.0	49	24	2	1	4932352347	4002395370061
2.5	57	30	2	1	4932352348	4002395370078
3.0	61	33	2	1	4932352349	4002395370085
3.2	65	36	2	1	4932352350	4002395370092
3.5	70	39	2	1	4932352351	4002395370108
4.0	75	43	2	1	4932352352	4002395370115
4.2	75	43	1	1	4932352353	4002395370122
4.5	80	47	1	1	4932352354	4002395370139
4.8	86	52	1	1	4932352355	4002395370146
5.0	86	52	1	1	4932352356	4002395370153
5.5	93	57	1	1	4932352357	4002395370160
6.0	93	57	1	1	4932352358	4002395370177
6.5	101	63	1	1	4932352359	4002395370184
6.8	109	69	1	1	4932352360	4002395370191
7.0	109	69	1	1	4932352361	4002395370207
7.5	109	69	1	1	4932352362	4002395370214
8.0	117	75	1	1	4932352363	4002395370221
8.5	117	75	1	1	4932352364	4002395370238
9.0	125	81	1	1	4932352365	4002395370245
9.5	125	81	1	1	4932352366	4002395370252
10.0	133	87	1	1	4932352367	4002395370269
10.5	133	87	1	1	4932352368	4002395370276
11.0	142	94	1	1	4932352369	4002395370283
11.5	142	94	1	1	4932352370	4002395370290
12.0	151	101	1	1	4932352371	4002395370306
12.5	151	101	1	1	4932352372	4002395370313
13.0	151	101	1	1	4932352373	4002395370320

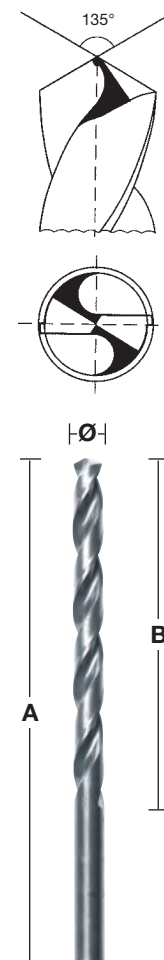

THUNDERWEB - DIN 338 - 5 and 10 pack

Diameter (mm)	Total length (mm)	Working length (mm)	Pack quantity	Min. order quantity	Article Number	EAN Code
1	34	12	10	1	4932352377	4002395370368
1.1	36	14	10	1	4932459826	4058546029982
1.2	38	16	10	1	4932459827	4058546029999
1.3	38	16	10	1	4932459828	4058546030001
1.4	40	18	10	1	4932459829	4058546030018
1.5	40	18	10	1	4932352378	4002395370375
1.6	43	20	10	1	4932459830	4058546030025
1.7	43	20	10	1	4932459831	4058546030032
1.8	46	22	10	1	4932459832	4058546030049
1.9	46	22	10	1	4932459833	4058546030056
2	49	24	10	1	4932352379	4002395370382
2.1	49	24	10	1	4932459834	4058546030063
2.2	53	27	10	1	4932459835	4058546030070
2.3	53	27	10	1	4932459836	4058546030087
2.4	57	30	10	1	4932430569	4002395382309
2.5	57	30	10	1	4932352380	4002395370399
2.6	57	30	10	1	4932459837	4058546030094
2.7	61	33	10	1	4932459838	4058546030100
2.8	61	33	10	1	4932459839	4058546030117
2.9	61	33	10	1	4932459840	4058546030124
3	61	33	10	1	4932352381	4002395370405
3.1	65	36	10	1	4932459841	4058546030131
3.2	65	36	10	1	4932352382	4002395370412
3.3	65	36	10	1	4932459842	4058546030148
3.4	70	39	10	1	4932459843	4058546030155



THUNDERWEB - DIN 338 - 5 and 10 pack

Diameter (mm)	Total length (mm)	Working length (mm)	Pack quantity	Min. order quantity	Article Number	EAN Code
3.5	70	39	10	1	4932352383	4002395370429
3.6	70	39	10	1	4932459844	4058546030162
3.7	70	39	10	1	4932459845	4058546030179
3.8	75	43	10	1	4932430547	4002395382088
3.9	75	43	10	1	4932459846	4058546030186
4	75	43	10	1	4932352384	4002395370436
4.1	75	43	10	1	4932459847	4058546030193
4.2	75	43	10	1	4932352385	4002395370443
4.3	80	47	10	1	4932459848	4058546030209
4.4	80	47	10	1	4932459849	4058546030216
4.5	80	47	10	1	4932352386	4002395370450
4.6	80	47	10	1	4932459850	4058546030223
4.7	80	47	10	1	4932459851	4058546030230
4.8	86	52	10	1	4932352387	4002395370467
4.9	86	52	10	1	4932459852	4058546030247
5	86	52	10	1	4932352388	4002395370474
5.1	86	52	10	1	4932459853	4058546030254
5.2	86	52	10	1	4932430548	4002395382095
5.3	86	52	10	1	4932459854	4058546030261
5.4	93	57	10	1	4932459855	4058546030278
5.5	93	57	10	1	4932352389	4002395370481
5.6	93	57	10	1	4932430570	4002395382316
5.7	93	57	10	1	4932459856	4058546030285
5.8	93	57	10	1	4932430549	4002395382101
5.9	93	57	10	1	4932459857	4058546030292
6	93	57	10	1	4932352390	4002395370498
6.1	101	63	10	1	4932459858	4058546030308
6.2	101	63	10	1	4932430550	4002395382118
6.3	101	63	10	1	4932459859	4058546030315
6.4	101	63	10	1	4932430571	4002395382323
6.5	101	63	10	1	4932352391	4002395370504
6.6	101	63	5	1	4932459860	4058546030322
6.7	101	63	5	1	4932459861	4058546030339
6.8	109	69	5	1	4932352392	4002395370511
6.9	109	69	5	1	4932459862	4058546030346
7	109	69	5	1	4932352393	4002395370528
7.1	109	69	5	1	4932459863	4058546030353
7.2	109	69	5	1	4932430551	4002395382125
7.3	109	69	5	1	4932459864	4058546030360
7.4	109	69	5	1	4932459865	4058546030377
7.5	109	69	5	1	4932352394	4002395370535
7.6	117	75	5	1	4932459866	4058546030384
7.7	117	75	5	1	4932459867	4058546030391
7.8	117	75	5	1	4932459868	4058546030407
7.9	117	75	5	1	4932459869	4058546030414
8	117	75	5	1	4932352395	4002395370542
8.1	117	75	5	1	4932459870	4058546030421
8.2	117	75	5	1	4932430552	4002395382132
8.3	117	75	5	1	4932459871	4058546030438
8.4	117	75	5	1	4932430553	4002395382149
8.5	117	75	5	1	4932352396	4002395370559
8.6	125	81	5	1	4932459872	4058546030445
8.7	125	81	5	1	4932459873	4058546030452
8.8	125	81	5	1	4932459874	4058546030469
8.9	125	81	5	1	4932459875	4058546030476
9	125	81	5	1	4932352397	4002395370566
9.1	125	81	5	1	4932459876	4058546030483
9.2	125	81	5	1	4932459877	4058546030490
9.3	125	81	5	1	4932459878	4058546030506
9.4	125	81	5	1	4932459879	4058546030513
9.5	125	81	5	1	4932352398	4002395370573
9.6	133	87	5	1	4932459880	4058546030520
9.7	133	87	5	1	4932459881	4058546030537
9.8	133	87	5	1	4932459882	4058546030544



THUNDERWEB - DIN 338 - 5 and 10 pack

Diameter (mm)	Total length (mm)	Working length (mm)	Pack quantity	Min. order quantity	Article Number	EAN Code
9.9	133	87	5	1	4932459883	4058546030551
10	133	87	5	1	4932352399	4002395370580
10.5	133	87	5	1	4932352400	4002395370597
11	142	94	5	1	4932352401	4002395370603
11.5	142	94	5	1	4932352402	4002395370610
12	151	101	5	1	4932352403	4002395370627
12.5	151	101	5	1	4932352404	4002395370634
13	151	101	5	1	4932352405	4002395370641



THUNDERWEB - DIN 338 - cassettes

Description	Supplied in	Pack quantity	Min. order quantity	Article Number	EAN Code
THUNDERWEB HSS-G set (19pc)					
① Ø 1 / 1.5 / 2 / 2.5 / 3 / 3.5 / 4 / 4.5 / 5 / 5.5 / 6 / 6.5 / 7 / 7.5 / 8 / 8.5 / 9 / 9.5 / 10 mm	Plastic cassette	19	1	4932352374	4002395370337
Counter display					
② 6 x 19 pc HSS-G drill bits set (4932352374)	-	6	1	4932352375	4002395370344
THUNDERWEB HSS-G set (25pc)					
③ Ø 1 / 1.5 / 2 / 2.5 / 3 / 3.5 / 4 / 4.5 / 5 / 5.5 / 6 / 6.5 / 7 / 7.5 / 8 / 8.5 / 9 / 9.5 / 10 / 10.5 / 11 / 11.5 / 12 / 12.5 / 13 mm	Plastic cassette	25	1	4932352376	4002395370351



HSS-G metal drill bits - long - DIN 340 - 5 and 10 pack

High quality high speed steel. Split point DIN 1412 C.
 Right hand cutting edge.
 135° angle for improved centering.
 Most suitable for drilling deep holes in channels or where there are hollow sections.
 Suitable for drilling steel, cast iron, alloyed and non alloyed material up to 900 N/mm².
 Also suitable for wood and plastics.

Diameter (mm)	Total length (mm) A	Working length (mm) B	Pack quantity	Min. order quantity	Article Number	EAN Code
2.0	85	56	10	1	4932430328	4002395379897
2.5	95	62	10	1	4932430329	4002395379903
3.0	100	66	10	1	4932430330	4002395379910
3.5	112	73	10	1	4932430331	4002395379927
4.0	119	78	10	1	4932430332	4002395379934
4.5	126	82	10	1	4932430333	4002395379941
5.0	132	87	10	1	4932430334	4002395379958
5.5	139	91	10	1	4932430335	4002395379965
6.0	139	91	10	1	4932430336	4002395379972
6.5	148	97	10	1	4932430337	4002395379989
7.0	156	102	10	1	4932430338	4002395379996
8.0	165	109	10	1	4932430339	4002395380008
9.0	175	115	10	1	4932430340	4002395380015
10.0	184	121	10	1	4932430341	4002395380022
11.0	195	128	5	1	4932430342	4002395380039
12.0	205	134	5	1	4932430343	4002395380046
13.0	205	134	5	1	4932430344	4002395380053



HSS-G metal drill bits - short - DIN 1897 - 5 and 10 pack

Drill bit quality: High quality high speed steel. Tip geometry: Split Point DIN 1412 C. Point angle: 135°. Tolerance: h8. Flute / Helix angle: Type N flute and normal 20 - 30° angle. Right hand cutting edge. Surface / Colour: Polished silver. Withstands high drill point pressure due to short overall length. Excellent concentricity. Polished type N flute with right hand cutting edge, eliminates binding for faster chip removal and faster cutting with less effort. Application: Most suited for drilling sheet and thin walled materials. Suitable for drilling in sheet steel, thin alloyed and non-alloyed material up to 900 N/mm². Also suitable for wood and plastics.

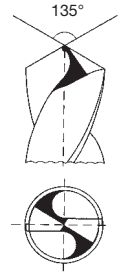

Diameter (mm)	Total length (mm) A	Working length (mm) B	Pack quantity	Min. order quantity	Article Number	EAN Code
2.0	38	12	10	1	4932352200	4002395368532
2.5	43	14	10	1	4932352201	4002395368549
3.0	46	16	10	1	4932352202	4002395368556
3.2	49	18	10	1	4932352203	4002395368563
3.3	49	18	10	1	4932352204	4002395368570
3.5	52	20	10	1	4932352205	4002395368587
3.7	52	20	10	1	4932352206	4002395368594
4.0	55	22	10	1	4932352207	4002395368600
4.2	55	22	10	1	4932352208	4002395368617
4.5	58	24	10	1	4932352209	4002395368624
4.8	62	26	10	1	4932352210	4002395368631
5.0	62	26	10	1	4932352211	4002395368648
5.2	62	26	10	1	4932352212	4002395368655
5.5	66	28	10	1	4932352213	4002395368662
6.0	66	28	10	1	4932352214	4002395368679
6.5	70	31	10	1	4932352215	4002395368686
7.0	74	34	5	1	4932352216	4002395368693
7.5	74	34	5	1	4932352217	4002395368709
8.0	79	37	5	1	4932352218	4002395368716
8.5	79	37	5	1	4932352219	4002395368723
9.0	84	40	5	1	4932352220	4002395368730
10.0	89	43	5	1	4932352221	4002395368747

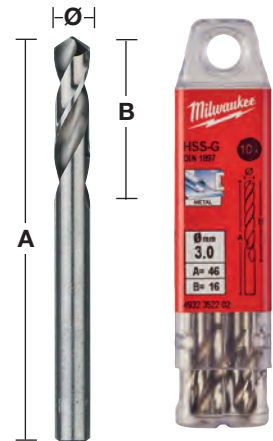

HSS-G metal drill bits - double ended - 10 pack

Drill bit quality: High quality high speed steel. Tip geometry: Split Point DIN 1412 C. Point angle: 135°. Tolerance: h8. Flute / Helix angle: Type N flute and normal 20 - 30° angle. Right hand cutting edge. Surface / Colour: Polished silver. Split point tip for good centering. Both ends can be used. Due to its short length it can be used with higher feed pressure without the risk of breakage. Excellent concentricity. Polished type N flute with right hand cutting edge, eliminates binding for faster chip removal and faster cutting with less effort. Application: Suitable drilling in steel, non-ferrous metals and plastic. Most suitable for thin sheet materials e.g. rivet holes.

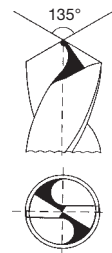

Diameter (mm)	Total length (mm) A	Working length (mm) B	Pack quantity	Min. order quantity	Article Number	EAN Code
2.5	43	10	10	1	4932352222	4002395368754
3.0	46	11	10	1	4932352223	4002395368761
3.2	49	12	10	1	4932352224	4002395368778
3.3	49	12	10	1	4932352225	4002395368785
3.5	52	14	10	1	4932352226	4002395368792
4.0	55	14	10	1	4932352227	4002395368808
4.1	55	14	10	1	4932352228	4002395368815
4.2	55	14	10	1	4932352229	4002395368822
4.5	58	16	10	1	4932352230	4002395368839
4.8	62	18	10	1	4932352231	4002395368846
5.0	62	18	10	1	4932352232	4002395368853
5.5	66	19	10	1	4932352233	4002395368860
6.0	66	19	10	1	4932352234	4002395368877

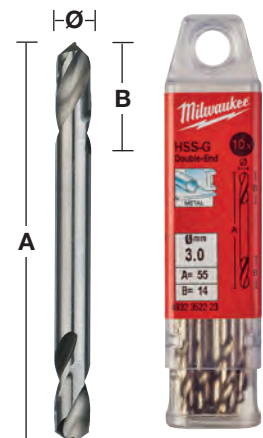

Metal drill bits HSS rollforged - DIN 338 - 5 and 10 pack

High speed steel rollforged metal drill bits produced according to DIN 338. Oxide coating enables quick swarf removal. Normal point shaped cutting tip with 118° angle. Type N flute normal angle. Suitable for drilling in steel, cast iron, alloyed and non-alloyed material up to 800 N/mm². Colour: black.

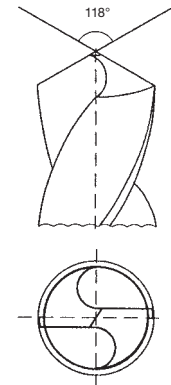

Diameter (mm)	Total length (mm) A	Working length (mm) B	Pack quantity	Min. order quantity	Article Number	EAN Code
1.0	34	12	10	1	4932363444	4002395329458
1.5	40	18	10	1	4932363449	4002395329502
2.0	49	24	10	1	4932363454	4002395329557
2.5	57	30	10	1	4932363459	4002395329601
3.0	61	33	10	1	4932363464	4002395329656
3.2	65	36	10	1	4932363466	4002395329670
3.5	70	39	10	1	4932363469	4002395329700
4.0	75	43	10	1	4932363474	4002395329755
4.2	75	43	10	1	4932363476	4002395329779
4.5	80	47	10	1	4932363479	4002395329809
4.8	86	52	10	1	4932363482	4002395329830
5.0	86	52	10	1	4932363484	4002395329854
5.5	93	57	10	1	4932363489	4002395329908
6.0	93	57	10	1	4932363494	4002395329953
6.5	101	63	10	1	4932363499	4002395330003
6.8	109	69	10	1	4932363502	4002395330034
7.0	109	69	10	1	4932363504	4002395330058
7.5	109	69	10	1	4932363509	4002395330102
8.0	117	75	10	1	4932363514	4002395330157
8.5	117	75	10	1	4932363519	4002395330201
9.0	125	81	10	1	4932363524	4002395330256
9.5	125	81	10	1	4932363529	4002395330300
10.0	133	87	10	1	4932363534	4002395330355
10.5	133	87	5	1	4932363539	4002395330409
11.0	142	94	5	1	4932363544	4002395330454
11.5	142	94	5	1	4932363549	4002395330508
12.0	151	101	5	1	4932363554	4002395330553
12.5	151	101	5	1	4932363559	4002395330607
13.0	151	101	5	1	4932363564	4002395330652



Metal drill bits HSS rollforged - DIN 338 - cassettes

Description	Supplied in	Pack quantity	Min. order quantity	Article Number	EAN Code
HSS-R drill bits set (19pc)					
① Ø 1 / 1.5 / 2 / 2.5 / 3 / 3.5 / 4 / 4.5 / 5 / 5.5 / 6 / 6.5 / 7 / 7.5 / 8 / 8.5 / 9 / 9.5 / 10 mm	Metal case	19	1	4932352468	4002395371273
HSS-R drill bits set (25pc)					
② Ø 1 / 1.5 / 2 / 2.5 / 3 / 3.5 / 4 / 4.5 / 5 / 5.5 / 6 / 6.5 / 7 / 7.5 / 8 / 8.5 / 9 / 9.5 / 10 / 10.5 / 11 / 11.5 / 12 / 12.5 / 13 mm	Metal case	25	1	4932352469	4002395371280

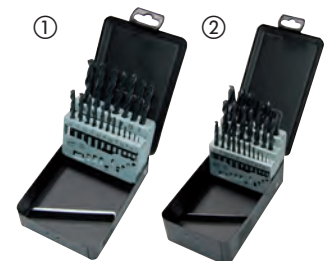

Metal drill bits HSS Rollforged - DIN 338 with reduced shank

High speed steel rollforged metal drill bits produced according to DIN 338.

Oxide coating enables quick swarf removal.

Normal point shaped cutting tip with 118° angle.

Type N flute normal angle.

Suitable for drilling in steel, cast iron, alloyed and non-alloyed material up to 800 N/mm².

Colour: black.

Ø 13.5 mm - Ø 16 mm = 10 mm shank / Ø 16.5 mm - Ø 20 mm = 13 mm shank.

Diameter (mm)	Total length (mm) A	Working length (mm) B	Pack quantity	Min. order quantity	Article Number	EAN Code
13.5	160	108	1	1	4932373318	4002395348435
14.0	160	108	1	1	4932373319	4002395348442
14.5	169	108	1	1	4932373320	4002395348459
15.0	169	114	1	1	4932373321	4002395348466
15.5	178	120	1	1	4932373322	4002395348473
16.0	178	120	1	1	4932373323	4002395348480
16.5	184	125	1	1	4932373324	4002395348497
17.0	184	125	1	1	4932373325	4002395349104
17.5	191	130	1	1	4932373326	4002395349111
18.0	191	130	1	1	4932373327	4002395349128
18.5	198	135	1	1	4932373328	4002395349135
19.0	198	135	1	1	4932373329	4002395349142
19.5	205	140	1	1	4932373330	4002395349159
20.0	205	140	1	1	4932373331	4002395349166

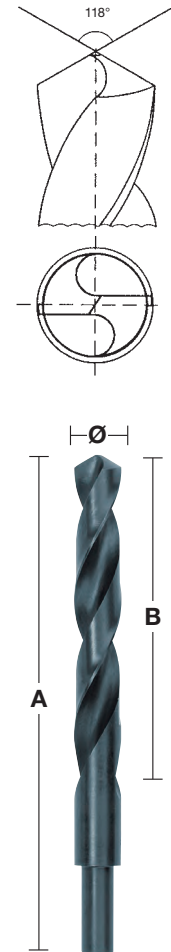

Metal drill bits HSS rollforged - DIN 338 - 345 pc cabinet

Diameter (mm)	Total length (mm) A	Working length (mm) B	Pack quantity	Min. order quantity	Article Number	EAN Code
Metal drill bit cabinet with HSS rollforged metal drill bits (345pc)			345	1	4932352674	4002395373321
1.0	34	12	20			
1.5	40	18	20			
2	49	24	20			
2.5	57	30	20			
3	61	33	20			
3.5	70	39	20			
4	75	43	20			
4.5	80	47	20			
5	86	52	20			
5.5	93	57	20			
6	93	57	20			
6.5	101	63	20			
7	109	69	10			
7.5	109	69	10			
8	117	75	20			
8.5	117	75	10			
9	125	81	10			
9.5	125	81	5			
10	133	87	10			
10.5	133	87	5			
11	142	94	5			
11.5	142	94	5			
12	151	101	5			
12.5	151	101	5			
13	151	101	5			



NEW COBALT STEP DRILLS



New Aluminum Chromium Nitride (AlCrN) coating for 10x more life vs. MILWAUKEE® standard step drill. For steel and stainless steel.

MATERIALS:

STEEL	COPPER	BRASS	ALUMINIUM	STAINLESS STEEL	PLASTIC
-------	--------	-------	-----------	-----------------	---------

- 1 RAPID STRIKE TIP™: Accurate start without walking and fast drilling without the need to pre-drill the material.
- 2 Optimised 2 flute ground sharpened edge geometry for 2 x faster and smoother cutting.
- 3 Special tip and step geometry for jam-free performance - less risk of drill snagging when used with high speed cordless tools and also prevents deformation of the drilled material.
- 4 Produced from custom engineered steel with black oxide coating for 4 x longer life.
- 5 Laser engraved size markings for best long term visibility.
- 6 Each step is relief ground to drill and deburr automatically.
- 7 With 3 flat secure grip to prevent step drill from slipping in the chuck and ensure maximum transmission of torque.



TRADES:



Drilling of panels and cabinets for cable gland installation



Access holes for pipework and installation



Various sizes and hole enlargement



Holes for cable installation



Various applications, sizes and hole enlargement

Cobalt step drills

NEW

New Aluminum Chromium Nitride (AlCrN) coating for 10x more life vs. MILWAUKEE[®] standard step drill.

For steel and stainless steel.

RAPID STRIKE TIP[™]: Accurate start without walking and fast drilling without the need to pre-drill the material.

Special tip and step geometry for jam-free performance - less risk of drill snagging when used with cordless tools and also prevents deformation of the drilled material.

Optimised 2 flute ground sharpened edge geometry for 2 x faster and smoother cutting.

With 3 flat secure grip to prevent step drill from slipping in the chuck and ensure maximum transmission of torque.

Laser engraved size markings for best long term visibility.

Description	Shank diameter (mm)	Overall length (mm)	No. of steps	Pack quantity	Min. order quantity	Article Number	EAN Code
① 4 - 20 mm	8	62	10	1	1	48899372	045242603862
② 6 - 35 mm	10	86	16	1	1	48899395	045242567676
③ M6 - M32	10	90	14	1	1	48899380	045242567652
④ Cobalt Step Drill Set (2pc) Includes 2 cobalt step drill bits: 4 - 20 mm, 6 - 35 mm				2	1	48899398	045242529216

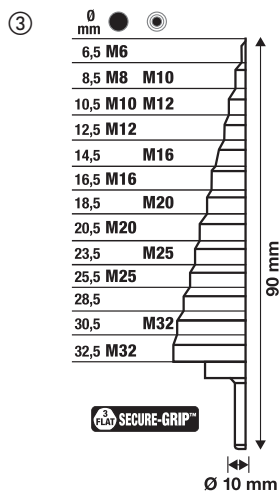
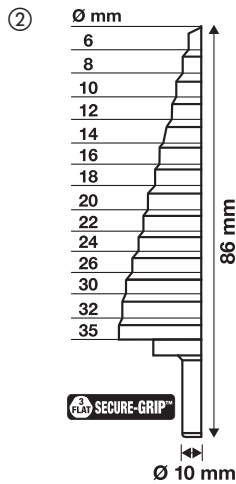
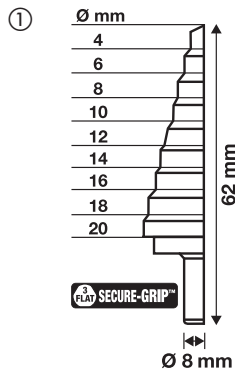

Step drills

	Description	Shank diameter (mm)	Overall length (mm)	No. of steps	Pack quantity	Min. order quantity	Article Number	EAN Code
①	PG7 - PG21	10	68	9	1	1	48899321	045242364060
②	M6 - M32	10	92	13	1	1	48899332	045242344437
③	4 - 12 mm / 1	6	65	9	1	1	48899301	045242342532
④	4 - 20 mm	8	65	9	1	1	48899320	045242344406
⑤	6 - 35 mm	10	90	14	1	1	48899335	045242344413
⑥	6 - 40.5 mm	10	90	17	1	1	48899340	045242547777

Step drill set (3pc)

⑦ Includes 3 step drill bits: 4 - 12 mm/1, 4 - 20 mm, 6 - 35 mm

Step & drill bit combo set (10pc)

⑧ Includes 2 x step drill bits: 4 - 12 mm/1, 4 - 20 mm. THUNDERWEB metal drill bits: 2 x 2 mm, 2 x 3 mm, 2 x 4 mm, 1 x 5 mm, 1 x 6mm

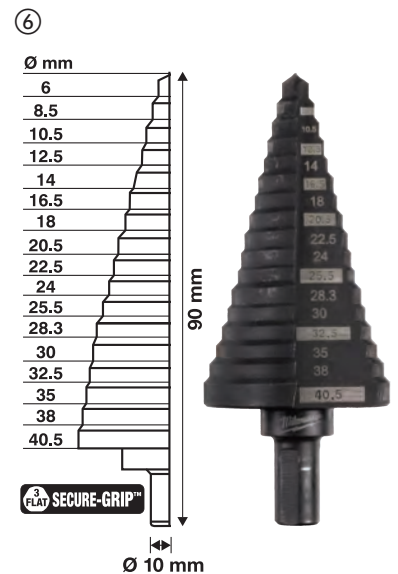
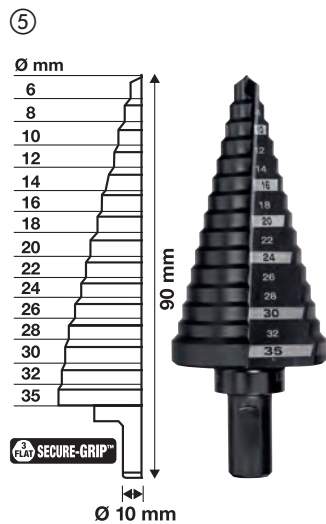
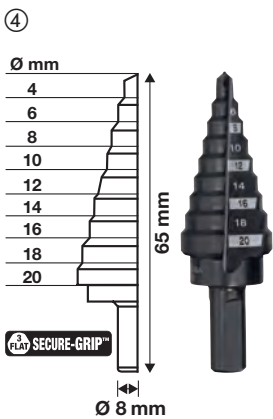
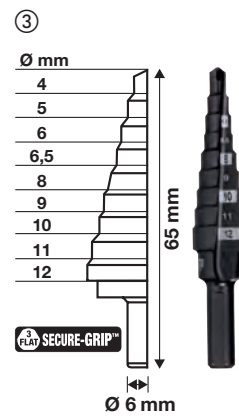
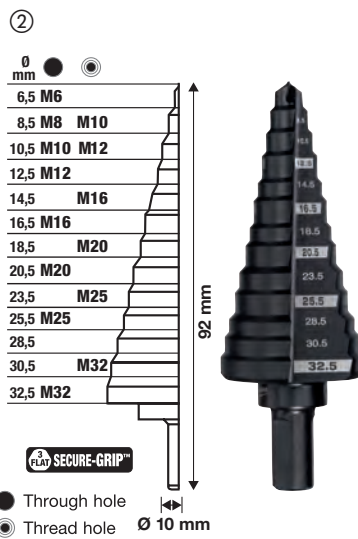

SHOCKWAVE™ IMPACT DUTY step drills

SHOCKWAVE™ Impact Duty step drills are designed to deliver best-in-class performance in impact drivers and also the versatility to be used in drill drivers.

The 1/4" Hex shank with an optimised SHOCKZONE™ ensures maximum durability by preventing early shank breaks.

New Titanium Aluminium Nitride coating helps to reduce heat generation for 5x more life.

RAPID STRIKE TIP™: Accurate start without walking and fast drilling without the need to pre-drill the material.

Dual spiral flute design: Optimised for impact driver speed and for smooth, jam-free drilling.

Laser engraved markings: Do not wear away with time.



Description	Shank diameter (mm)	Overall length (mm)	No. of steps	Pack quantity	Min. order quantity	Article Number	EAN Code
① 4 - 12 mm / 1"	1/4" Hex	83	9	1	1	48899261	045242505166
② 4 - 12 mm / 2"	1/4" Hex	83	5	1	1	48899262	045242505173
③ 4 - 20 mm	1/4" Hex	83	9	1	1	48899263	045242505180
④ 4 - 30 mm	1/4" Hex	95	12	1	1	48899265	045242505203
⑤ SHOCKWAVE™ Impact Duty step drill set (3pc) Includes 3 SHOCKWAVE™ step drill bits: 4 - 12 mm/1, 4 - 20 mm, 4 - 30 mm				3	1	48899266	045242505210

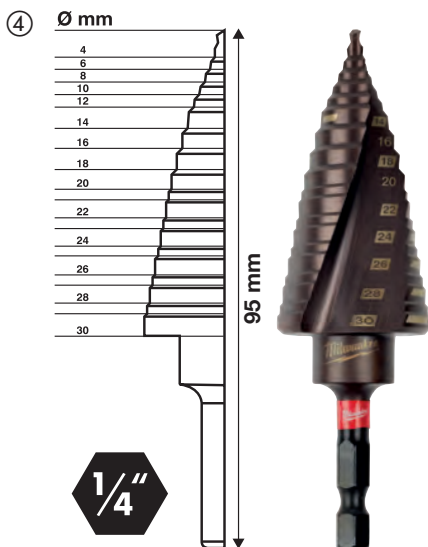
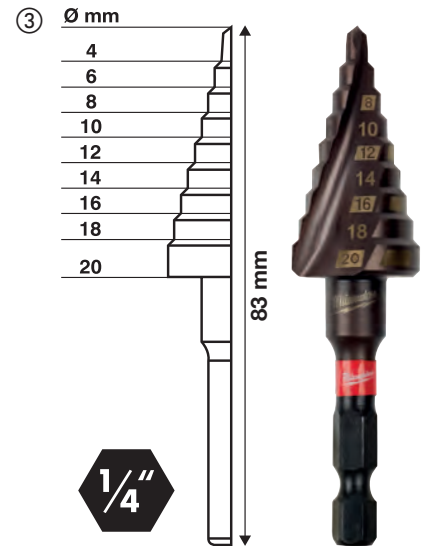
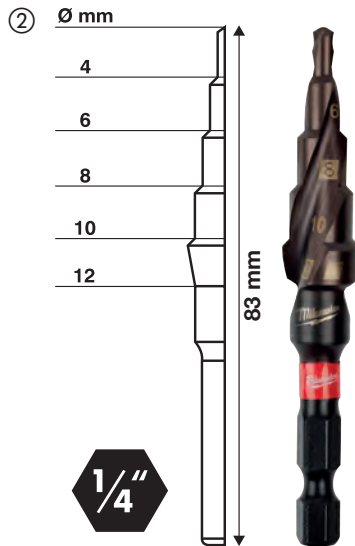
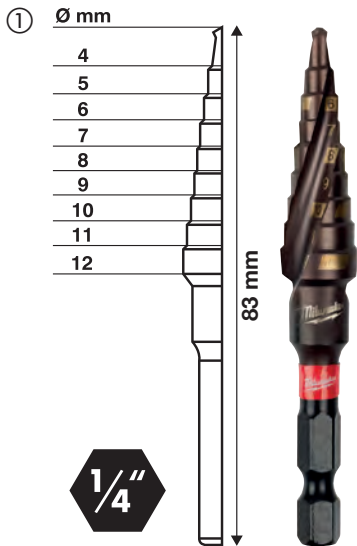

Magnetic Drilling

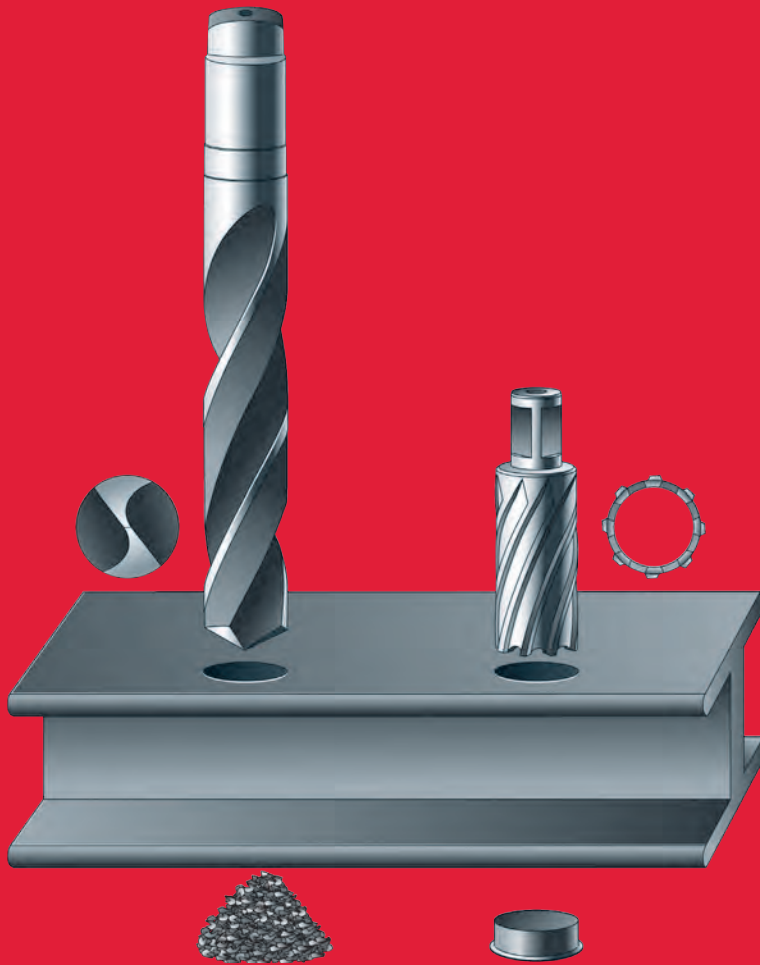

100% Faster

Speed and time savings are achieved due to the following factors. Firstly the annular cutter principle of only cutting material from the periphery of the hole as opposed to the twist drill which must cut the complete diameter of the hole. Secondly the benefit of two aggressive sharp angles per cutting edge help to achieve faster feed rates and lower cutting resistance.

30% More productivity

Because the annular cutter is only cutting material from the periphery of the hole. Less motor energy and driving power is required. The larger the drill diameter the greater the energy saving.

Longer lifetime

The annular cutters cutting edges do less work than the twist drill resulting in more holes between sharpening. Thick 6 mm body together with special tooth geometry ensures high stability and reduces to a minimum the risk of breakage due to overloading.

Speed chart

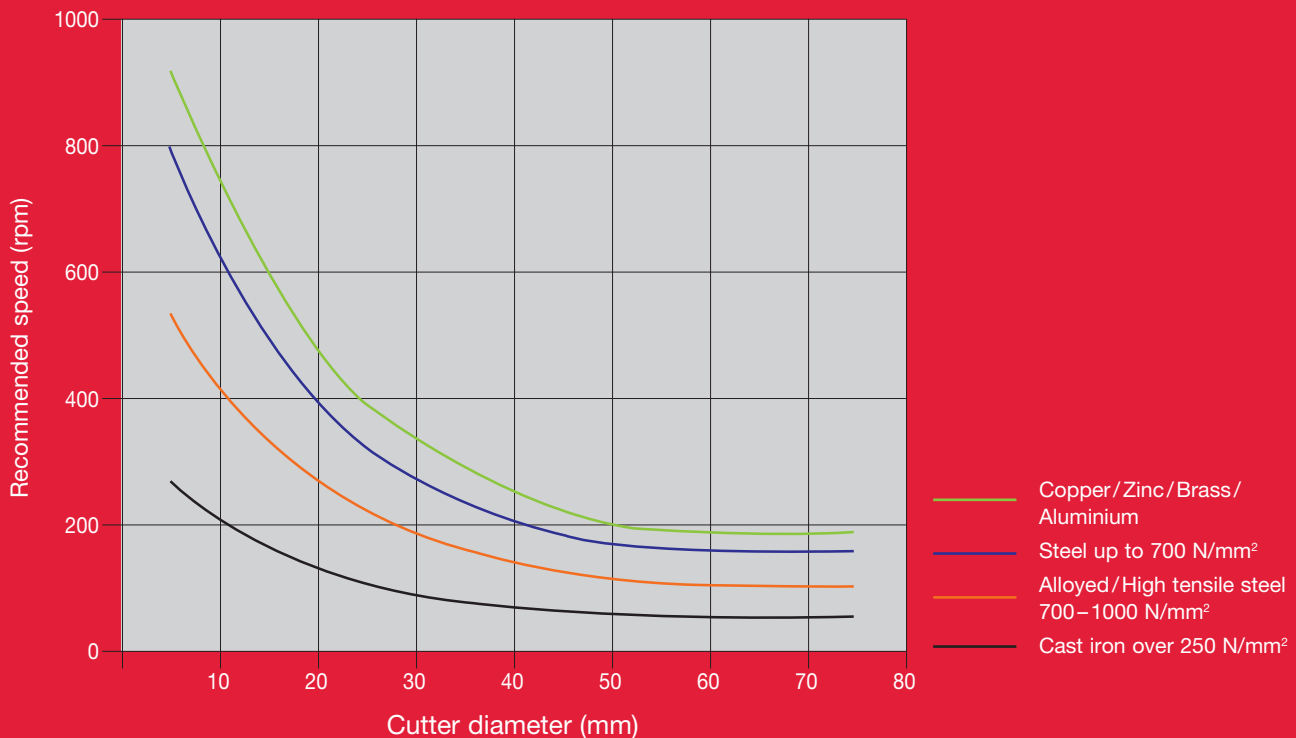

HSS annular cutters 30 mm

Thick walled HSS annular cutters for increased durability and life time. With standard 19 mm Weldon reception.

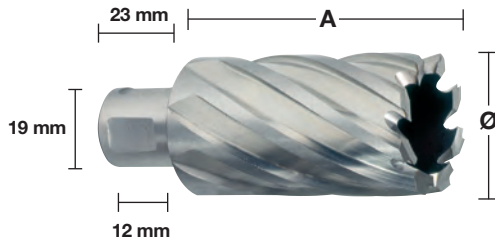

30 mm

Diameter (mm)	Total length (mm) A	Pack quantity	Min. order quantity	Article Number	EAN Code
12	30	1	1	4932371740	4002395344161
13	30	1	1	4932371741	4002395344178
14	30	1	1	4932343270	4002395315130
15	30	1	1	4932343271	4002395315147
16	30	1	1	4932343272	4002395315154
17	30	1	1	4932343273	4002395315161
18	30	1	1	4932343274	4002395315178
19	30	1	1	4932343275	4002395315185
20	30	1	1	4932343276	4002395315192
21	30	1	1	4932343277	4002395315208
22	30	1	1	4932343278	4002395315215
23	30	1	1	4932343279	4002395315222
24	30	1	1	4932343280	4002395315239
25	30	1	1	4932343281	4002395315246
26	30	1	1	4932343282	4002395315253
27	30	1	1	4932343283	4002395315260
28	30	1	1	4932343284	4002395315277
29	30	1	1	4932343285	4002395315284
30	30	1	1	4932343286	4002395315291
31	30	1	1	4932343287	4002395315307
32	30	1	1	4932343288	4002395315314
33	30	1	1	4932371742	4002395344185
34	30	1	1	4932371743	4002395344192
35	30	1	1	4932371744	4002395344208
36	30	1	1	4932371745	4002395344215
37	30	1	1	4932371746	4002395344222
38	30	1	1	4932371747	4002395344239
39	30	1	1	4932371748	4002395344246
40	30	1	1	4932371749	4002395344253
41	30	1	1	4932371750	4002395344260
42	30	1	1	4932371751	4002395344277
43	30	1	1	4932371752	4002395344284
44	30	1	1	4932371753	4002395344291
45	30	1	1	4932371754	4002395344307
46	30	1	1	4932371755	4002395344314
47	30	1	1	4932371756	4002395344321
48	30	1	1	4932371757	4002395344338
49	30	1	1	4932371758	4002395344345
50	30	1	1	4932371759	4002395344352



50 mm

Diameter (mm)	Total length (mm) A	Pack quantity	Min. order quantity	Article Number	EAN Code
14	50	1	1	4932343289	4002395315352
15	50	1	1	4932343290	4002395315369
16	50	1	1	4932343291	4002395315376
17	50	1	1	4932343292	4002395315383
18	50	1	1	4932343293	4002395315390
19	50	1	1	4932343294	4002395315406
20	50	1	1	4932343295	4002395315413
21	50	1	1	4932343296	4002395315420
22	50	1	1	4932343297	4002395315437
23	50	1	1	4932343298	4002395315444
24	50	1	1	4932343299	4002395315451
25	50	1	1	4932343300	4002395315468
26	50	1	1	4932343301	4002395315475
27	50	1	1	4932343302	4002395315482
28	50	1	1	4932343303	4002395315499
29	50	1	1	4932343304	4002395315505
30	50	1	1	4932343305	4002395315512
31	50	1	1	4932343306	4002395315529
32	50	1	1	4932343307	4002395315536
33	50	1	1	4932371760	4002395344369
34	50	1	1	4932371761	4002395344376
35	50	1	1	4932371762	4002395344383
36	50	1	1	4932371763	4002395344390
37	50	1	1	4932371764	4002395344406
38	50	1	1	4932371765	4002395344413
39	50	1	1	4932371766	4002395344420
40	50	1	1	4932371767	4002395344437
41	50	1	1	4932371768	4002395344444
42	50	1	1	4932371769	4002395344451
43	50	1	1	4932371770	4002395344468
44	50	1	1	4932371771	4002395344475
45	50	1	1	4932371772	4002395344482
46	50	1	1	4932371773	4002395344499
47	50	1	1	4932371774	4002395344505
48	50	1	1	4932371775	4002395344512
49	50	1	1	4932371776	4002395344529
50	50	1	1	4932371777	4002395344536

Description	Supplied in	Pack quantity	Min. order quantity	Article Number	EAN Code
Telescopic ejector pin for 30 mm cutters		2	1	49590011	045242364039
Telescopic ejector pin for 50 mm cutters		2	1	49590012	045242364046
HSS annular cutter set (6pc)					
① 6 x HSS annular cutters: Ø 14 / 16 / 18 / 20 / 22 / 24 mm - 19 mm Weldon reception. 1 x ejector pin short series - 30 mm	Plastic case	6	1	4932372533	4002395345236

System accessories - Magnetic drill stands



4932604226

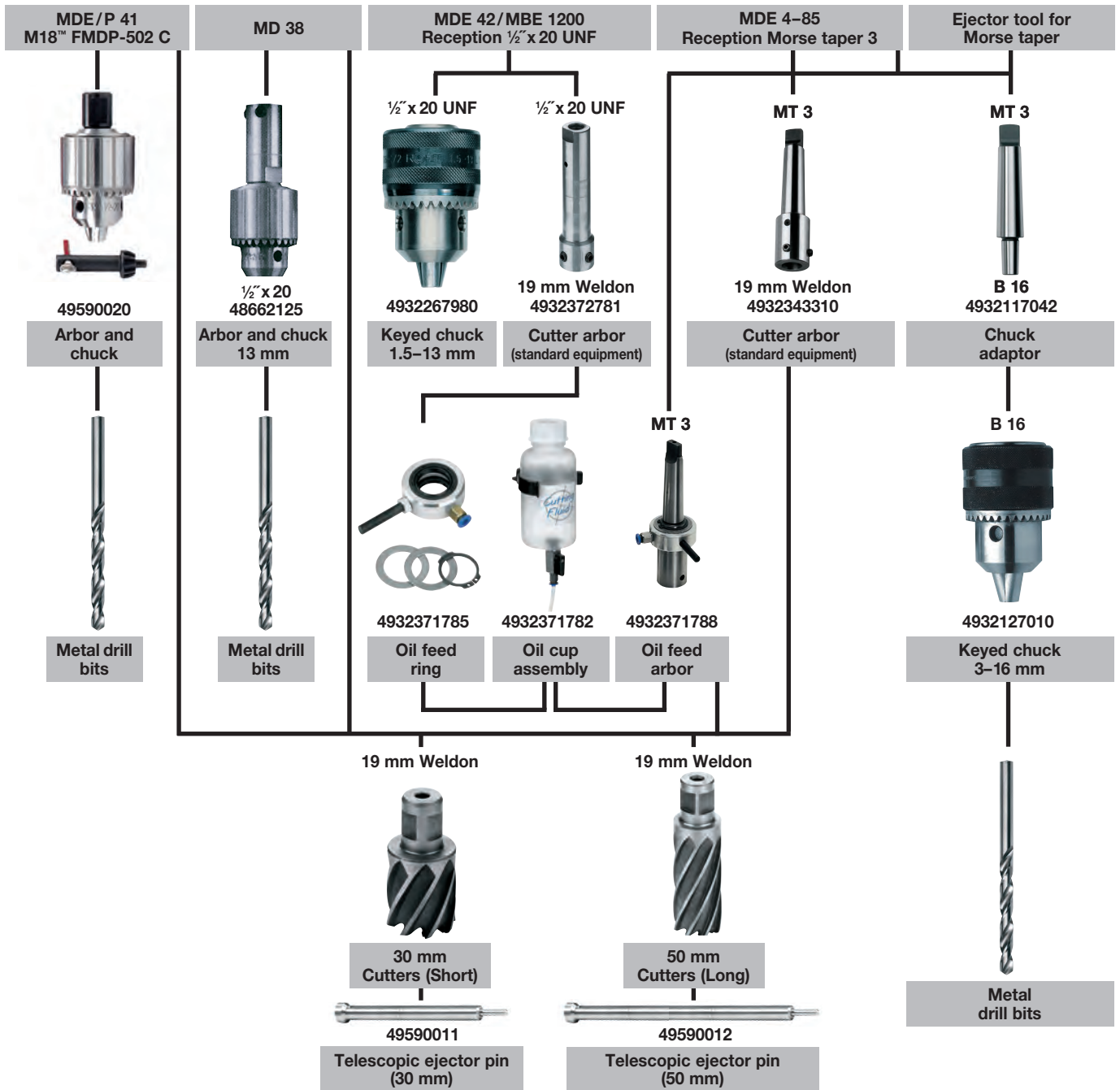



Nothing but **HEAVY DUTY**.™

MILWAUKEE® HOLESAW RANGE

If you're cutting or boring holes, look no further than our range of holesaws and the HOLEDZER™ product line.





HOLE DOZER™

The MILWAUKEE® HOLE DOZER™ is the jobsite workhorse that provides unstoppable durability through the most demanding applications.

Multiple leverage points to remove material out of the holesaw for faster plug removal.

- Deepest access for thick plugs
- Higher access for thin material
- Minimises downtime between cuts
- New coating allows less friction and increases drilling speed

PLUG JACK™



A 3.5 teeth per inch tooth design with a positive 10° tooth angle provides the following benefits:

- Faster and more aggressive cut.
- Improved heat dispersion during cutting ensures that the teeth stay sharper for longer.
- Deeper curved gullets provide more efficient chip clearance preventing clogging and heat build up.
- Special shaped tooth angle has less tendency to snag on thinner materials.

This high quality holesaw range is the perfect solution for cutting all types of materials: - Steel up to 1000 N/mm² strength - Stainless steel and acid resistant steel - Non-ferrous metals - Cast iron - Aluminium - Wood - Medium density fibreboard (MDF) - Gypsum plasterboard - Sandwich materials - PVC.

HOLE DOZER[™] bi-metal holesaws

Diameter (mm)	Ø (inch)	Max. cutting depth (mm)	Pack quantity	Min. order quantity	Article Number	EAN Code
14	9/16	41	1	1	49560002	045242271061
16	5/8	41	1	1	49560012	045242192922
17	11/16	41	1	1	49560014	045242193639
19	3/4	41	1	1	49560023	045242192632
20	25/32	41	1	1	49560024	045242271016
21	13/16	41	1	1	49560027	045242192649
22	7/8	41	1	1	49560032	045242192878
24	15/16	41	1	1	49560037	045242192885
25	1	41	1	1	49560043	045242192526
27	1 1/16	41	1	1	49560047	045242192892
29	1 1/8	41	1	1	49560052	045242192939
30	1 3/16	41	1	1	49560057	045242192946
32	1 1/4	41	1	1	49560062	045242192977
33	1 5/16	41	1	1	49560067	045242192984
35	1 3/8	41	1	1	49560072	045242192991
37	1 7/16	41	1	1	49560077	045242193028
38	1 1/2	41	1	1	49560082	045242193035
40	1 9/16	41	1	1	49560087	045242193042
41	1 5/8	41	1	1	49560092	045242193073
43	1 11/16	41	1	1	49560097	045242193080
44	1 3/4	41	1	1	49560102	045242193097
46	1 13/16	41	1	1	49560107	045242193127
48	1 7/8	41	1	1	49560112	045242193134
50	1 31/32	41	1	1	49560113	045242271023
51	2	41	1	1	49560117	045242193141
52	2 1/16	41	1	1	49560122	045242193172
54	2 1/8	41	1	1	49560127	045242193189
56	4/6	41	1	1	49560129	045242504664
57	2 1/4	41	1	1	49560132	045242193196
59	2 5/16	41	1	1	49560137	045242193226
60	2 3/8	41	1	1	49560142	045242193233
64	2 1/2	41	1	1	49560147	045242193240
65	2 9/16	41	1	1	49560153	045242193271
67	2 5/8	41	1	1	49560158	045242193288
68	2 11/16	41	1	1	49560159	045242271030
70	2 3/4	41	1	1	49560163	045242193295
73	2 7/8	41	1	1	49560167	045242193325
76	3	41	1	1	49560173	045242193332
79	3 1/8	41	1	1	49560177	045242193349
83	3 1/4	41	1	1	49560183	045242193370
86	3 3/8	41	1	1	49560187	045242193387
89	3 1/2	41	1	1	49560193	045242193394
92	3 5/8	41	1	1	49560197	045242193431
95	3 3/4	41	1	1	49560203	045242193448
98	3 7/8	41	1	1	49560207	045242193479
102	4	41	1	1	49560213	045242193486
105	4 1/8	41	1	1	49560217	045242193493
108	4 1/4	41	1	1	49560223	045242193523
111	4 3/8	41	1	1	49560227	045242193530
114	4 1/2	41	1	1	49560233	045242193547
117	4 5/8	41	1	1	49560239	045242587285
121	4 3/4	41	1	1	49560237	045242193578
127	5	41	1	1	49560243	045242193585
133	5 1/4	41	1	1	49560244	045242271078
140	5 1/2	41	1	1	49560247	045242193592
152	6	41	1	1	49560253	045242193622
160	6 5/16	38	1	1	4932399885	4002395365395
168	6 5/8	38	1	1	4932399886	4002395365401
177	6 31/32	38	1	1	4932399887	4002395365418
200	7 7/8	38	1	1	4932399888	4002395365425
210	8 9/32	38	1	1	4932399889	4002395365432



HOLE DOZER™ bi-metal holesaws - bulk packs

Diameter (mm)	Ø (inch)	Max. cutting depth (mm)	Pack quantity	Min. order quantity	Article Number	EAN Code
19	3/4	41	1	25	49565090	045242176199
20	25/32	41	1	25	49565091	045242528943
22	7/8	41	1	25	49565100	045242156375
25	1	41	1	25	49565110	045242156382
29	1 1/8	41	1	25	49565120	045242156399
30	1 3/16	41	1	25	49565125	045242243976
32	1 1/4	41	1	25	49565130	045242156412
35	1 3/8	41	1	25	49565140	045242156429
38	1 1/2	41	1	25	49565150	045242156436
41	1 5/8	41	1	25	49565152	045242176229
44	1 3/4	41	1	25	49565155	045242176267
51	2	41	1	25	49565160	045242156443
54	2 1/8	41	1	25	49565165	045242176366
57	2 1/4	41	1	25	49565167	045242176373
60	2 3/8	41	1	25	49565169	045242528950
64	2 1/2	41	1	25	49565170	045242156467
67	2 5/8	41	1	16	49565175	045242176380
68	2 11/16	41	1	16	49565178	045242528967
76	3	41	1	16	49565180	045242176397
89	3 1/2	41	1	9	49565190	045242176403
92	3 5/8	41	1	9	49565195	045242176410
102	4	41	1	9	49565200	045242176427
105	4 1/8	41	1	9	49565205	045242176434



HOLE DOZER[™] bi-metal holesaws - sets

Description	Pack quantity	Min. order quantity	Article Number	EAN Code
7 pc Hole Dozer[™] Holesaw set				
① 5 x holesaws: Ø 19, 22, 25, 29, 32 mm. Arbor for Ø 14 - 30 mm holesaws. Spacer and adaptor. 1/8" allen key	7	1	49224083	045242310760
Hole Dozer[™] holesaw set (10pc)				
② 6 x holesaws: Ø 25, 32, 40, 54, 68, 76 mm. Arbor for Ø 14 - 30 mm holesaws. Arbor for Ø 32 - 152 mm holesaws. 2 x pilot drill bits. 1/8" allen key	10	1	49224201	045242348091
Hole Dozer[™] holesaw set (14pc)				
③ 10 x holesaws: Ø 19, 22, 25, 29, 32, 35, 38, 44, 51, 57 mm. Arbor for Ø 14 - 30 mm holesaws. Arbor for Ø 32 - 152 mm holesaws. 2 x pilot drill bits. 1/8" allen key	14	1	49224152	045242271047
Hole Dozer[™] holesaw set (17pc)				
④ 13 x holesaws: Ø 20, 22, 25, 32, 40, 44, 51, 57, 64, 65, 67, 68, 76 mm. Arbor for Ø 14 - 30 mm holesaws. Arbor for Ø 32 - 152 mm holesaws. 2 x pilot drill bits. 1/8" allen key	17	1	49224102	045242271054
Kit box for holesaws				
⑤ Arbor with pilot drill bit (49567010). Arbor with pilot drill bit (49569100). 2 x Pilot drill bits. 1/8" allen key (49960060)	4	1	4932430327	4002395379880
Hole Dozer[™] PACKOUT[™] holesaw set (12pc)				
⑥ 10 x holesaws: Ø 20, 25, 32, 35, 40, 44, 51, 54, 68, 76 mm. Arbor for Ø 14 - 30 mm holesaws. Arbor for Ø 32 - 152 mm holesaws. 1/8" allen key	12	1	4932472248	4058546338947



HOLE DOZER™ carbide holesaws

Up to 10x more life, high heat and wear resistance compared to Bi-Metal holesaws.

3 Tpi aggressive tooth geometry with large gullets for improved material removal.

Offset teeth for less resistance.

PLUG JACK™ slot geometry provides deep access to remove thick plugs and high leverage for thin materials.

Application areas: metalworking (stainless steel, high alloy steels, aluminium) and composites (plastics, sandwich material, computer flooring, fibreglass, plastic coated wood boards, nail embedded wood).



Diameter (mm)	Ø (inch)	Max. cutting depth (mm)	Pack quantity	Min. order quantity	Article Number	EAN Code
19	3/4	41	1	1	49560702	045242503971
22	7/8	41	1	1	49560704	045242503995
25	1	41	1	1	49560707	045242504008
27	1 1/16	41	1	1	49560807	045242594764
29	1 1/8	41	1	1	49560708	045242504015
32	1 1/4	41	1	1	49560710	045242504022
33	1 5/16	41	1	1	49560711	045242630790
35	1 3/8	41	1	1	49560712	045242504039
38	1 1/2	41	1	1	49560713	045242504053
41	1 5/8	41	1	1	49560714	045242594771
44	1 3/4	41	1	1	49560717	045242504107
48	1 7/8	41	1	1	49560719	045242504114
51	2	41	1	1	49560720	045242504145
54	2 1/8	41	1	1	49560722	045242504152
57	2 1/4	41	1	1	49560724	045242504169
60	2 3/8	41	1	1	49560726	045242504176
64	2 1/2	41	1	1	49560727	045242504183
65	2 9/16	41	1	1	49560728	045242594788
67	2 5/8	41	1	1	49560729	045242504190
68	2 11/16	41	1	1	49560730	045242594795
70	2 3/4	41	1	1	49560731	045242504206
76	3	41	1	1	49560734	045242504220
79	3 1/8	41	1	1	49560735	045242603831
83	3 1/4	41	1	1	49560736	045242504237
86	3 3/8	41	1	1	49560737	045242594801
89	3 1/2	41	1	1	49560738	045242504244
92	3 5/8	41	1	1	49560739	045242504251
102	4	41	1	1	49560742	045242504275
108	4 1/4	41	1	1	49560744	045242504282
114	4 1/2	41	1	1	49560746	045242504299
121	4 3/4	41	1	1	49560847	045242594849
127	5	41	1	1	49560748	045242504305
140	5 1/2	41	1	1	49560848	045242594856
152	6	41	1	1	49560749	045242504312
Carbide Hole Dozer™ set (9pc)			9	1	49223079	045242533039



5 x carbide holesaws: Ø 22, 29, 35, 51, 64 mm. Arbor for Ø 14 - 30 mm (49567010). Arbor for Ø 32 - 152 mm (49569100). 2 x HSS-Cobalt pilot drill bits. 1/8" allen key



Bi-Metal contractor holesaws

Optimised variable 4-6 tooth geometry for faster cutting and universal use.

Bi-Metal teeth for best durability and increased wear resistance.

For universal use: steel, non ferrous metals, wood, drywall plasterboard, plastics.

Diameter (mm)	Ø (inch)	Max. cutting depth (mm)	Pack quantity	Min. order quantity	Article Number	EAN Code
14	9/16	38	1	1	4932464671	4058546226169
16	5/8	38	1	1	4932464672	4058546226176
19	3/4	38	1	1	4932464673	4058546226183
20	25/32	38	1	1	4932464674	4058546226190
21	13/16	38	1	1	4932464675	4058546226206
22	7/8	38	1	1	4932464676	4058546226213
24	15/16	38	1	1	4932464677	4058546226220
25	1	38	1	1	4932464678	4058546226237
27	1 1/16	38	1	1	4932464679	4058546226244
29	1 1/8	38	1	1	4932464680	4058546226251
30	1 3/16	38	1	1	4932464681	4058546226268
32	1 1/4	38	1	1	4932464682	4058546226275
35	1 3/8	38	1	1	4932464683	4058546226282
38	1 1/2	38	1	1	4932464684	4058546226299
40	1 9/16	38	1	1	4932464685	4058546226305
43	1 11/16	38	1	1	4932464686	4058546226312
44	1 3/4	38	1	1	4932464687	4058546226329
48	1 7/8	38	1	1	4932464688	4058546226336
51	2	38	1	1	4932464689	4058546226343
54	2 1/8	38	1	1	4932464690	4058546226350
56	4/6	38	1	1	4932464691	4058546226367
57	2 1/4	38	1	1	4932464692	4058546226374
60	2 3/8	38	1	1	4932464693	4058546226381
64	2 1/2	38	1	1	4932464694	4058546226398
65	2 9/16	38	1	1	4932464695	4058546226404
67	2 5/8	38	1	1	4932464696	4058546226411
68	2 11/16	38	1	1	4932464697	4058546226428
70	2 3/4	38	1	1	4932464698	4058546226435
73	2 7/8	38	1	1	4932464699	4058546226442
76	3	38	1	1	4932464700	4058546226459
79	3 1/8	38	1	1	4932464701	4058546226466
83	3 1/4	38	1	1	4932464702	4058546226473
89	3 1/2	38	1	1	4932464703	4058546226480
92	3 5/8	38	1	1	4932464704	4058546226497
98	3 7/8	38	1	1	4932464705	4058546226503
102	4	38	1	1	4932464706	4058546226510
105	4 1/8	38	1	1	4932464707	4058546226527
114	4 1/2	38	1	1	4932464708	4058546226534
121	4 3/4	38	1	1	4932464709	4058546226541
127	5	38	1	1	4932464710	4058546226558
152	6	38	1	1	4932464711	4058546226565



Bi-Metal contractor holesaw - sets

Optimised variable 4/6 tooth geometry for faster cutting and universal use.

Bi-Metal teeth for best durability and increased wear resistance.

For universal use: steel, non-ferrous metals, wood, drywall plasterboard, plastics.

Description	Pack quantity	Min. order quantity	Article Number	EAN Code
Bi-metal contractor holesaw set (10pc) ① 6 x Holesaws: Ø 25, 32, 40, 54, 68, 76 mm. 1x arbor for Ø 14 - 30 mm. 1 x arbor for Ø 32 - 152 mm. 2 x pilot drill bits. Allen key	10	1	4932464719	4058546226640
Bi-Metal contractor holesaw set (14pc) ② 10 x Holesaws: Ø 19, 22, 25, 29, 32, 35, 38, 44, 51, 57 mm. 1 x arbor for Ø 14 - 30 mm. 1 x arbor for Ø 32 - 152 mm. 2 x pilot drill bits. Allen key	14	1	4932464720	4058546226657



System accessories - Holesaws

Description	Fits holesaw Ø	Shank reception	Holesaw or core reception	Pack quantity	Min. order quantity	Article Number	EAN Code
① Arbor	Ø 14-30 mm	9.5 mm Hex	1/2" x 20	1	1	4932479465	4058546372590
② Arbor	Ø 32-210 mm	9.5 mm Hex	5/8" x 18	1	1	4932479466	4058546372606
③ Arbor	Ø 32-210 mm	11 mm Hex	5/8" x 18	1	1	4932479467	4058546372613
④ SDS-Plus arbor	Ø 14-30 mm	SDS-Plus	1/2" x 20	1	1	4932471694	4058546295936
⑤ SDS-Plus arbor	Ø 32-210 mm	SDS-Plus	5/8" x 18	1	1	4932471695	4058546295943
⑥ Extension - 300 mm long	-	9.5 mm Hex	-	1	1	4932479470	4058546372644
⑥ Extension - 305 mm long	-	7/16" Hex	-	1	1	4932479494	4058546372880
⑦ Pilot drill bit HSS-Ground Ø 6 mm x 89 mm length. Fits to all arbors				1	1	4932479468	4058546372620
⑦ Pilot drill long HSS-Ground Ø 6 mm x 100 mm length. Fits to all arbors				1	1	4932479469	4058546372637
⑧ Pilot drill HSS-Cobalt Ø 6 mm x 89 mm length. Fits to all arbors				1	1	49567100	045242612093
⑨ Hex key 1/8" for all arbors				1	1	49960060	045242221455
⑩ Grub screw for arbors and extensions				1	1	06832712	4002395874354



Adjustable hole cutter

For cutting large diameter holes for air conditioning pipes, fans, downlights and ceiling speakers. Dust collection shroud for 100% dust free work when overhead drilling. Diameter is adjustable from 51 mm to 178 mm in 6.4 mm steps. Laser marked preset diameters at 51 - 178 mm. Suitable for use on drywall (max. 25 mm) and ceiling tile. Not suitable for OSB wood boards.

Description	Pack quantity	Min. order quantity	Article Number	EAN Code
Adjustable hole cutter				
① Pilot drill, 2 blades, QL arbor and dust collection shroud	5	1	49560260	045242350261
② QL arbor with 1/4" Hex reception. 75 mm long	1	1	4932479553	4058546373474
Replacement blade and pilot drill set (4pc)				
③ 1 x pilot drill bit, 2 x blades and 1 x allen key	4	1	49560290	045242346370



HOLE DOZER[™] holesaws: Recommended cutting speed in RPM

Diameter (mm)	Ø (inch)	Metal	Cast Iron	Stainless steel	Non ferrous metal	Aluminium	Wood	MDF
14	9/16	580	400	300	790	900	1500	750
16	5/8	550	365	275	730	825	1500	750
17	11/16	500	330	250	665	750	1500	750
19	3/4	460	300	230	600	690	1500	750
20	25/32	425	280	210	560	635	1500	750
21	13/16	425	280	210	560	635	1500	750
22	7/8	390	260	195	520	585	1500	750
23	29/32	370	250	185	500	550	1500	750
25	1	350	235	175	470	525	1500	750
27	1 1/16	325	215	160	435	480	1400	700
29	1 1/8	300	200	150	400	450	1400	700
30	1 3/16	285	190	145	380	425	1400	700
32	1 1/4	275	180	140	380	410	1400	700
33	1 5/16	260	175	135	345	390	1400	700
35	1 3/8	250	165	125	330	375	1400	700
37	1 7/16	240	160	120	315	360	1400	700
38	1 1/2	230	150	115	300	345	1400	700
40	1 9/16	220	145	110	290	330	1200	600
41	1 5/8	210	140	105	280	315	1200	600
43	1 11/16	205	135	100	270	305	1200	600
44	1 3/4	195	130	95	260	295	1200	600
46	1 13/16	190	125	95	250	285	1200	600
48	1 7/8	180	120	90	240	270	1200	600
50	1 31/32	175	120	85	230	260	1200	600
51	2	170	115	85	230	255	1200	600
52	2 1/16	165	110	80	220	245	1200	600
54	2 1/8	150	100	75	200	225	1000	500
56	4/6	145	100	75	195	225	1000	500
57	2 1/4	145	100	75	195	225	1000	500
59	2 5/16	145	100	75	195	225	1000	500
60	2 3/8	140	95	70	190	220	1000	500
63	2 31/64	135	90	65	180	205	900	450
64	2 1/2	135	90	65	180	205	900	450
65	2 9/16	130	85	65	175	200	800	400
68	2 11/16	125	80	60	160	185	800	400
73	2 7/8	120	80	60	160	180	800	400
76	3	115	75	55	150	170	700	350
79	3 1/8	110	70	55	140	165	700	350
83	3 1/4	105	50	40	140	155	700	350
86	3 3/8	100	45	30	130	150	500	250
89	3 1/2	95	45	30	130	145	500	250
92	3 5/8	95	60	45	120	140	500	250
95	3 3/4	90	60	45	120	135	500	250
98	3 7/8	90	60	45	120	135	500	250
102	4	85	55	40	110	130	400	200
105	4 1/8	80	55	40	110	120	400	200
111	4 3/8	80	50	40	100	120	300	150
114	4 1/2	75	50	35	100	105	300	150
121	4 3/4	75	50	35	95	95	300	150
127	5	65	45	30	90	90	200	100
133	5 1/4	60	40	25	85	85	200	100
140	5 1/2	60	40	25	85	85	200	100
146	5 3/4	55	35	25	75	75	200	100
152	6	55	35	25	75	75	200	100
160	6 5/16	50	30	25	60	60	150	75
168	6 3/8	50	30	25	55	55	150	75
177	6 31/32	45	25	25	55	55	150	75
200	7 7/8	40	25	25	50	50	100	50
210	8 9/32	40	20	25	50	50	100	50
	-	Cutting oil	Dry	Cutting oil	Cutting oil	Turpentine	Dry	Dry



Speed kills!

Operating at higher speeds than those recommended will shorten the life of the holesaw and produce very inefficient cutting.



Feed Pressure:

Variables in material, work configuration should be considered. Apply sufficient feed pressure to aid good chip re-removal. Reduce the pressure when the holesaw becomes hot or if the teeth start to clog with material. Insufficient feed pressure will dull tooth points prematurely but too much pressure can totally destroy teeth.



Cooling Lubricant:

Cutting oil serves two purposes when sawing in metals. It cools the saw and the work piece. It reduces heat and abrasion which can shorten cutting life. It also aids re-moving swarf from the cutting surface. Using a cooling lubricant will extend the life of your holesaw by 500%.

T.C.T. Stainless steel holesaws

Carbide tooth technology provides for best performance, speed and 10x more lifetime than standard bi-metal holesaws. Teeth can also be resharpened.

Extra deep 25 mm cutting depth for drilling in sheet material and pipes.

One solid piece holesaw design reduces wobble and vibration for accurate drilling.

Safety stop collar prevents over drilling for best safety.

Ejector spring helps eject the slug, prevents jamming and saves time.

With 3-flat secure grip shank reception to prevent the holesaw slipping in the chuck and to ensure maximum torque transmission. Diameters 16-76 mm with 10 mm and >80 mm with 13 mm 3-flat shank reception.

Replaceable pilot drill and spring.

Use a cooling lubricant to extend the life of the holesaw. For metals use cutting oil, aluminium turpentine, plastics water and for cast iron drill dry.

Suitable for drilling steel (<1200 N/mm²) up to 4 mm, stainless steel up to 2 mm, aluminium, zink, cast iron, copper, fibreglass and PVC.

Diameter (mm)	Max. cutting depth (mm)	Pack quantity	Min. order quantity	Article Number	EAN Code
16	25	1	1	4932479033	4058546363239
18	25	1	1	4932479034	4058546368289
19	25	1	1	4932479035	4058546368296
20	25	1	1	4932479036	4058546368302
22	25	1	1	4932479037	4058546368319
24	25	1	1	4932479038	4058546368326
25	25	1	1	4932479039	4058546368333
29	25	1	1	4932479040	4058546368340
30	25	1	1	4932479041	4058546368357
32	25	1	1	4932479042	4058546368364
35	25	1	1	4932479043	4058546368371
38	25	1	1	4932479044	4058546368388
40	25	1	1	4932479045	4058546368395
44	25	1	1	4932479046	4058546368401
45	25	1	1	4932479047	4058546368418
50	25	1	1	4932479048	4058546368425
51	25	1	1	4932479049	4058546368432
54	25	1	1	4932479050	4058546368449
60	25	1	1	4932479051	4058546368456
64	25	1	1	4932479052	4058546368463
70	25	1	1	4932479053	4058546368470
76	25	1	1	4932479054	4058546368487
80	25	1	1	4932479055	4058546368494
85	25	1	1	4932479056	4058546368500
102	25	1	1	4932479057	4058546368517
T.C.T. holesaw set (4pc)		4	1	4932479058	4058546368524
4 x T.C.T. holesaws: Ø16, 20, 25, 32 mm. 1/8" allen key					
Pilot drill bit (Ø6 x 76mm) including spring for T.C.T. holesaws		1	1	4932479059	4058546368531
Spring for T.C.T. holesaw pilot drill		3	1	4932479060	4058546368548
Grub screw M6 for T.C.T. holesaw arbor		3	1	4932479061	4058546368555

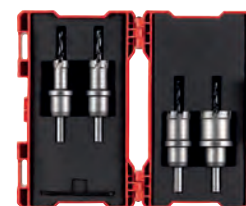

Holesaw Ø mm	Speed - RPM	
	Steel < 800N/mm ²	Stainless Steel / Steel < 1200N/mm ²
16	995	696
20	796	557
25	637	446
30	531	371
35	455	318
40	398	279
45	354	248
50	318	223
55	289	203
60	265	186
65	245	171
70	227	159
75	212	149
80	199	139
85	187	131
90	177	124
95	168	117
100	159	111

BIG HAWG[™] multi material holesaws

BIG HAWG[™] multi material holesaws are ideal for electricians, carpenters, kitchen fitters & all related heating, ventilation and plumbing trades.

Designed for use in a wide variety of materials:

Bricks* - suitable for both solid bricks and bricks with cavities.

Aerated concrete blocks*, lightweight aggregate blocks and breeze blocks.

Soft density lime-sandstone building blocks up to hardness of 30 N/mm².

Softwoods, chipboard, plywood, medium density fibreboard (MDF).

Plastics and plastic coated board (Contiboard).

* Not suitable for use in hard materials such as concrete, granite, medium to hard density lime-sandstone block, natural stone and hard brick over 30 N/mm² hardness.



Diameter (mm)	Max. cutting depth (mm)	No. of teeth	Pack quantity	Min. order quantity	Article Number	EAN Code
25	60	2	1	1	4932464921	4058546228668
30	60	2	1	1	4932464922	4058546228675
35	60	2	1	1	4932464923	4058546228682
44	60	2	1	1	4932464924	4058546228699
51	60	3	1	1	4932464925	4058546228705
54	60	3	1	1	4932464926	4058546228712
57	60	3	1	1	4932464927	4058546228729
65	60	3	1	1	4932464928	4058546228736
68	60	3	1	1	4932464929	4058546228743
70	60	3	1	1	4932464930	4058546228750
76	60	3	1	1	4932464931	4058546228767
82	60	3	1	1	4932464932	4058546228774
92	60	3	1	1	4932464933	4058546228781
102	60	3	1	1	4932464934	4058546228798
108	60	3	1	1	4932464935	4058546228804
117	60	3	1	1	4932464936	4058546228811
133	60	3	1	1	4932464937	4058546228828
159	60	3	1	1	4932464938	4058546228835



BIG HAWG[™] multi material holesaws - set

Description	Pack quantity	Min. order quantity	Article Number	EAN Code
BIG HAWG[™] multi material set (10 pc)				
6 x holesaws: Ø 35, 44, 51, 57, 68, 76 mm. 1 x arbor with pilot drill. 2 x pilot drill. 1 x diamond file. Allen key	10	1	4932464939	4058546228842



BIG HAWG[™] multi material - system accessories

Description	Pack quantity	Min. order quantity	Article Number	EAN Code
① BIG HAWG [™] multi material pilot drill	1	1	4932464940	4058546228859
② BIG HAWG [™] 7/16" multi material arbor with pilot drill	1	1	4932464941	4058546228866
③ Pilot drill flat bit 3/16" for wood only	1	1	48271401	045242121397



HCS holesaws

Optimised 5 Tpi tooth geometry for clean cuts in soft materials.
For use in plastics and drywall plasterboard.

Diameter (mm)	Max. cutting depth (mm)	Pack quantity	Min. order quantity	Article Number	EAN Code
121	96	1	1	4932472076	4058546324728
127	96	1	1	4932472077	4058546324735
133	96	1	1	4932472078	4058546324742
138	96	1	1	4932472079	4058546324759
150	96	1	1	4932472080	4058546324766
168	96	1	1	4932472081	4058546324773
172	96	1	1	4932472082	4058546324780
177	96	1	1	4932472083	4058546324797
186	96	1	1	4932472084	4058546324803
210	96	1	1	4932472085	4058546324810
212	96	1	1	4932472086	4058546324827
226	96	1	1	4932472087	4058546324834



System accessories - HCS holesaws

System accessories to be used with HCS holesaws.

1. Arbor with pilot drill
2. Pilot drill

Description	Pack quantity	Min. order quantity	Article Number	EAN Code
① HCS holesaws arbor with pilot drill	1	1	4932472088	4058546324841
② HCS holesaw pilot drill Ø6 and 150 mm length	1	1	4932472089	4058546324858



IMPACT HOLESAWS



Optimised for use with cordless tools



- ① Thin wall
– 8 TPI = smooth burr free holes
– 0.6 mm thick = less resistance
- ② Shallow cup optimised for drilling thin metal
- ③ 8% Cobalt Bi-Metal for best durability and lifetime
- ④ Ejection spring auto ejects slugs
- ⑤ Stop shoulder prevents over drilling
- ⑥ 1/4" Hex shank = impact driver compatible

Suitability

Max. 2 mm steel, aluminium and stainless steel (max. 1.5 mm)

SHOCKWAVE™ IMPACT DUTY holesaws

	Diameter (mm)	Pack quantity	Min. order quantity	Article Number	EAN Code
	19	1	1	49569805	045242321094
	22	1	1	49569810	045242321100
	25	1	1	49569815	045242321117
①	29	1	1	49569820	045242321124
	32	1	1	49569825	045242321131
	35	1	1	49569830	045242321148
	38	1	1	49569835	045242321155
②	SHOCKWAVE™ IMPACT DUTY holesaw set (3pc)		3	49224800	045242321162
	Ø 22 / 29 / 35 mm				
	Ejection spring and grub screw	1	1	4932430466	4002395381272
	Pilot drill bit with arbor	1	1	4932430477	4002395381388



APPLICATION AREAS

CERAMIC TILES

- All types hard and soft:
Porcelain / Gres / Granite / Quarry /
Terrazzo / Artificial stone / Terracota /
Agglomerate / Glazed

CAST IRON

FIBREGLASS / GRP

- (Glass reinforced plastic) / Perspex

HOW TO USE:

1. Screw the grinder adaptor M14 to the holesaw and tighten firmly with a spanner. Then apply the spindle lock on the angle grinder and fit the adaptor directly onto the spindle; tighten firmly with a spanner.
2. If the tile is not fitted to a wall or floor ensure it is secured firmly with a clamp.
3. Switch on the tool to full speed. Slowly approach the tile with the drill bit at a 20-30° angle with light pressure to avoid skating on the tile. Once the drill bit starts to cut into the tile and forms a groove, gradually raise the drill so that it is horizontal (90°) with the tile.
4. Apply light pressure and an oscillating circular motion during cutting to maximise tool life.
5. When cutting material thicker than 10 mm, to optimise life and speed of cut, lift the drill/hole saw out of the hole every 5 seconds and allow it to rotate in the air to cool before continuing with the cut.

M14 DIAMOND TILE DRILLBITS



Diamond grit drills and holesaws are designed for cutting holes in extremely hard materials such as porcelain/gres/quarry tiles, cast iron or fibreglass. These bits & holesaws guarantee superior life and fast cutting even in the hardest of materials. Can be used either on angle grinders with relevant adaptor or with a drill driver.

Minimal water cooling: A continuous flow of water is not required to cool the bits & holesaw during cutting. Simply dip them in water before starting the cut and every 5 seconds during cutting for optimal performance.

Clean holes: Drills clean, precise holes without any perimeter scratches.

Superior lifetime and durability due to the high grade diamond bond and the tough alloy body which resists bending under stress.

Easy slug removal due to the multiple access slots.

M14 diamond tile drill bit

Diameter (mm)	Reception	Pack quantity	Min. order quantity	Article Number	EAN Code
5	M14	1	1	4932471758	4058546296575
6	M14	1	1	4932471759	4058546296582
8	M14	1	1	4932471760	4058546296599
10	M14	1	1	4932471761	4058546296605
12	M14	1	1	4932471762	4058546296612
14	M14	1	1	4932471763	4058546296629
16	M14	1	1	4932471764	4058546296636
18	M14	1	1	4932478276	4058546344535
20	M14	1	1	4932478277	4058546344542
25	M14	1	1	4932478278	4058546344559
32	M14	1	1	4932478279	4058546344566
35	M14	1	1	4932478280	4058546344573
40	M14	1	1	4932478281	4058546344580
44	M14	1	1	4932478282	4058546344597
51	M14	1	1	4932478283	4058546344603
55	M14	1	1	4932478284	4058546344610
68	M14	1	1	4932478285	4058546344627
75	M14	1	1	4932478286	4058546344634
102	M14	1	1	4932478287	4058546344641
DIAMOND MAX™ diamond drill bit set (4pc)		4	1	4932471863	4058546297626
Ø 6, 8, 10, 14 mm					



Description	Tool reception	Shank reception	Pack quantity	Min. order quantity	Article Number	EAN Code
Adaptor to fit M14 diamond drills to MILWAUKEE® spot polisher	M9 x 0.75	M14	1	1	4932472090	4058546324865
Adaptor to fit M14 diamond drills to MILWAUKEE® die grinder	M16 x 1.0	M14	1	1	4932472265	4058546339111



M14 diamond router bit

For milling and modelling applications in different materials e.g. porcelain tiles, granite, natural stone, marble, engineering bricks, roof tiles and concrete.

For chamfering all the mentioned materials.

For expanding existing holes.

M14 thread: To fit directly onto an angle grinder.

Lifetime: To ensure long lifetime, we use high grade diamond for fast cutting and a superior brazed bond matrix to give best durability.

Description	Diameter (mm)	Working length (mm)	Pack quantity	Min. order quantity	Article Number	EAN Code
M14 diamond router bit	20	35	1	1	4932479078	4058546368722



M14 diamond cup wheel

Optimal for all types of repair work in confined spaces.

For removing and levelling tile adhesive when replacing broken tiles.

For grinding different materials e.g. granite, stone, porcelain tiles, ceramic tiles, concrete, screed and removing adhesives.

M14 thread: To fit directly onto an angle grinder.

Lifetime: To ensure long lifetime, we use high grade diamond for fast grinding and a superior bond matrix to give best durability.

Description	Diameter (mm)	Cup wheel height [mm]	Segment height (mm)	Pack quantity	Min. order quantity	Article Number	EAN Code
M14 diamond cup wheel	50	27	2	1	1	4932479079	4058546368739





HOW TO USE ON AN ANGLE GRINDER:

1. Screw the grinder adaptor M14 to the holesaw and tighten firmly with a spanner. Then apply the spindle lock on the angle grinder and fit the adaptor directly onto the spindle; tighten firmly with a spanner.
2. If the tile is not fitted to a wall or floor ensure it is secured firmly with a clamp.
3. Dip the holesaw tips into water.
4. Switch on angle grinder to full speed. Slowly approach the tile with the holesaw at a 20-30° angle with light pressure to avoid skating on the tile. Once the holesaw starts to cut into the tile and forms a groove, gradually raise the holesaw so that it is horizontal with the tile.
5. Every 5 seconds dip the holesaw in water.
6. Apply light pressure and an oscillating circular motion during cutting to maximise tool life.

APPLICATION AREAS

CERAMIC TILES



- All types hard and soft: Porcelain / Gres / Granite / Quarry / Terrazzo / Artificial stone / Terracota / Agglomerate / Glazed

CAST IRON



FIBREGLASS / GRP



- (Glass reinforced plastic) / Perspex

DIAMOND MAX™ 1/4" WET / DRY DRILL BITS



Diamond grit drills and holesaws are designed for cutting holes in extremely hard materials such as porcelain/gres/quarry tiles, cast iron or fibreglass. These bits & holesaws guarantee superior life and fast cutting even in the hardest of materials. Can be used either on angle grinders with relevant adaptor or with a drill driver.

Minimal water cooling: A continuous flow of water is not required to cool the bits & holesaw during cutting.

Simply dip them in water before starting the cut and every 5 seconds during cutting for optimal performance.

Clean holes: Drills clean, precise holes without any perimeter scratches.

Superior lifetime and durability due to the high grade diamond bond and the tough alloy body which resists bending under stress.

Easy slug removal due to the multiple access slots.

DIAMOND MAX™ 1/4" WET / DRY drill bits

Diameter (mm)	Reception	Pack quantity	Min. order quantity	Article Number	EAN Code
① 5	1/4" Hex	1	1	49560503	045242223732
6	1/4" Hex	1	1	49560505	045242223749
8	1/4" Hex	1	1	49560507	045242223756
10	1/4" Hex	1	1	49560509	045242223763
12	1/4" Hex	1	1	49560511	045242223770
15	1/4" Hex	1	1	49560513	045242223787
20	1/4" Hex	1	1	49560515	045242223794
25	1/4" Hex	1	1	49560517	045242223800

DIAMOND MAX™ diamond drill bit set (3pc)
 3 1 4932471771 4058546296704

Ø 6, 8, 10 mm



Diameter (mm)	Reception	Pack quantity	Min. order quantity	Article Number	EAN Code
22	1/2" x 20	1	1	49565605	045242308439
29	1/2" x 20	1	1	49565615	045242308446
32	5/8" x 18	1	1	49565620	045242308453
35	5/8" x 18	1	1	49565625	045242308460
② 38	5/8" x 18	1	1	49565630	045242308477
44	5/8" x 18	1	1	49565640	045242308491
51	5/8" x 18	1	1	49565645	045242308507
64	5/8" x 18	1	1	49565660	045242308521
68	5/8" x 18	1	1	49565664	045242337835



Description	Fits holesaw Ø	Shank reception	Holesaw or core reception	Pack quantity	Min. order quantity	Article Number	EAN Code
Arbor	Ø 14-30 mm	9.5 mm Hex	1/2" x 20	1	1	49567010	045242200177
Arbor	Ø 32-210 mm	9.5 mm Hex	5/8" x 18	1	1	49567250	045242225798
Grinder adaptor	Ø 22-29mm	M14	1/2" x 20	1	1	4932430464	4002395381258
Grinder adaptor	Ø 32-68mm	M14	5/8" x 18	1	1	4932430465	4002395381265

Holesaw drilling guide

Constant water supply significantly increases the drill bit lifetime.

Drilling guide provides a secure drilling into the material without slipping around and damaging the surface.

Easy fixing and removal from surfaces due to vacuum fixing.

Description	Pack quantity	Min. order quantity	Article Number	EAN Code
Drilling guide for drills / holesaws Ø 19 - 68 mm	1	1	4932352332	4002395369911



Wet Diamond Drilling Cores

- ① Standard 1 1/4" UNC reception
- ② Stamping of diameter and type on the core reception for longterm visibility
- ③ Laser welded segments guarantee against break off
- ③ 10 mm segment height for superior lifetime



THIN KERF Wet diamond drilling cores

Cordless optimised diamond segments designed especially for MXFuel tool.

Optimised for corded diamond drills up to 2200 Watt.

10 mm laser welded segments for superior lifetime.

Standard 1/2" G reception on smaller diameters & standard 1 1/4" UNC reception on bigger diameters.



Diameter (mm)	Description	Fits DD3 - 152	Fits MXF DCD 150	Core reception	Working length (mm) B	Total length (mm) A	Pack quantity	Min. order quantity	Article Number	EAN Code
12	WCHP-TK 12 mm	✓	✓	1/2" G	200	270	1	1	4932472167	4058546325633
14	WCHP-TK 14 mm	✓	✓	1/2" G	300	370	1	1	4932472168	4058546325640
16	WCHP-TK 16 mm	✓	✓	1/2" G	300	370	1	1	4932472169	4058546325657
18	WCHP-TK 18 mm	✓	✓	1/2" G	300	370	1	1	4932472170	4058546325664
20	WCHP-TK 20 mm	✓	✓	1/2" G	300	370	1	1	4932472171	4058546325671
22	WCHP-TK 22 mm	✓	✓	1/2" G	300	370	1	1	4932472172	4058546325688
24	WCHP-TK 24 mm	✓	✓	1/2" G	300	370	1	1	4932472173	4058546325695
25	WCHP-TK 25 mm	✓	✓	1/2" G	300	370	1	1	4932472174	4058546325701
28	WCHP-TK 28 mm	✓	✓	1/2" G	300	370	1	1	4932472175	4058546325718
30	WCHP-TK 30 mm	✓	✓	1/2" G	300	370	1	1	4932472176	4058546325725
32	WCHP-TK 32 mm	✓	✓	1/2" G	300	370	1	1	4932472177	4058546325732
35	WCHP-TK 35 mm	✓	✓	1/2" G	300	370	1	1	4932472178	4058546325749
40	WCHP-TK 40 mm	✓	✓	1/2" G	300	370	1	1	4932472180	4058546325763
46	WCHP-TK 46 mm	✓	✓	1 1/4" UNC	450	525	1	1	4932478953	4058546362355
51	WCHP-TK 51 mm	✓	✓	1 1/4" UNC	450	525	1	1	4932472184	4058546325800
56	WCHP-TK 56 mm	✓	✓	1 1/4" UNC	450	525	1	1	4932472185	4058546325817
61	WCHP-TK 61 mm	✓	✓	1 1/4" UNC	450	525	1	1	4932472186	4058546325824
66	WCHP-TK 66 mm	✓	✓	1 1/4" UNC	450	525	1	1	4932472187	4058546325831
68	WCHP-TK 68 mm	✓	✓	1 1/4" UNC	450	525	1	1	4932478954	4058546362362
71	WCHP-TK 71 mm	✓	✓	1 1/4" UNC	450	525	1	1	4932472188	4058546325848
76	WCHP-TK 76 mm	✓	✓	1 1/4" UNC	450	525	1	1	4932472189	4058546325855
81	WCHP-TK 81 mm	✓	✓	1 1/4" UNC	450	525	1	1	4932472190	4058546325862
86	WCHP-TK 86 mm	✓	✓	1 1/4" UNC	450	525	1	1	4932472191	4058546325879
91	WCHP-TK 91 mm	✓	✓	1 1/4" UNC	450	525	1	1	4932472192	4058546325886
101	WCHP-TK 101 mm	✓	✓	1 1/4" UNC	450	525	1	1	4932472193	4058546325893
105	WCHP-TK 105 mm	✓	✓	1 1/4" UNC	450	525	1	1	4932472194	4058546325909
111	WCHP-TK 111 mm	✓	✓	1 1/4" UNC	450	525	1	1	4932472195	4058546325916
121	WCHP-TK 121 mm	✓	✓	1 1/4" UNC	450	525	1	1	4932472196	4058546325923
126	WCHP-TK 126 mm	✓	✓	1 1/4" UNC	450	525	1	1	4932478955	4058546362379
130	WCHP-TK 130 mm	✓	✓	1 1/4" UNC	450	525	1	1	4932472197	4058546325930
140	WCHP-TK 140 mm	✓	✓	1 1/4" UNC	450	525	1	1	4932472198	4058546325947
150	WCHP-TK 150 mm	✓	✓	1 1/4" UNC	450	525	1	1	4932472199	4058546325954



Wet diamond drilling cores

Diameter (mm)	Description	Fits DD3-152	Fits DCM2-250C & DCM2-350C	Core reception	Working length (mm) B	Total length (mm) A	Pack quantity	Min. order quantity	Article Number	EAN Code
52	WCHP 52	✓	✓	1 ¼" UNC	450	525	1	1	4932399707	4002395363582
62	WCHP 62	✓	✓	1 ¼" UNC	450	525	1	1	4932399708	4002395363599
72	WCHP 72	✓	✓	1 ¼" UNC	450	525	1	1	4932399709	4002395363605
82	WCHP 82	✓	✓	1 ¼" UNC	450	525	1	1	4932399710	4002395363612
92	WCHP 92	✓	✓	1 ¼" UNC	450	525	1	1	4932399711	4002395363629
102	WCHP 102	✓	✓	1 ¼" UNC	450	525	1	1	4932399712	4002395363636
112	WCHP 112	✓	✓	1 ¼" UNC	450	525	1	1	4932399713	4002395363643
122	WCHP 122	✓	✓	1 ¼" UNC	450	525	1	1	4932399714	4002395363650
132	WCHP 132	✓	✓	1 ¼" UNC	450	525	1	1	4932399715	4002395363667
152	WCHP 152	✓	✓	1 ¼" UNC	450	525	1	1	4932399716	4002395363674
162	WCHP 162	✓	✓	1 ¼" UNC	450	525	1	1	4932399717	4002395363681
172	WCHP 172	✓	✓	1 ¼" UNC	450	525	1	1	4932352052	4002395367092
182	WCHP 182	✓	✓	1 ¼" UNC	450	525	1	1	4932399718	4002395363698
202	WCHP 202	✓	✓	1 ¼" UNC	450	525	1	1	4932399719	4002395363704
225	WCHP 225	✓	✓	1 ¼" UNC	450	525	1	1	4932399720	4002395363711
250	WCHP 250	✓	✓	1 ¼" UNC	450	525	1	1	4932399721	4002395363728
300	WCHP 300	✓	✓	1 ¼" UNC	450	525	1	1	4932399722	4002395363735
350	WCHP 350	✓	✓	1 ¼" UNC	450	525	1	1	4932399723	4002395363742

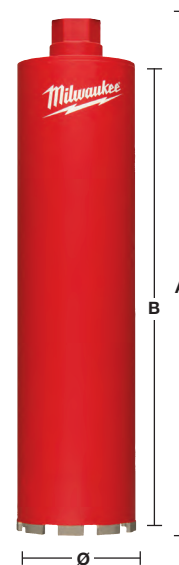

Dry diamond cores with dust extraction - DCHXL

10 mm high, laser welded segments for longer life.

Use with the machine set to rotary only, not suitable for hammer action.



Material	DCHXL	Material	DCHXL
Aerated/breeze concrete blocks	◆	Granite	✗
Artificial stone – hard	✗	Lime/sandstone – hard	✓
Brick – very hard, engineering brick	✓	Lime/sandstone – soft/abrasive	◆
Brick – medium	✓	Marble	✗
Brick – soft	◆	Tiles	✗
Concrete	✗		

✓ Most suitable. Recommended for these materials.
✗ Not suitable. Not recommended for these materials.

◆ Limited suitability – recommended for intermittent use.
Very good in drilling characteristics, but reduced lifetime.

Description	Diameter (mm)	Core reception	Working length (mm) B	Total length (mm) A	Pack quantity	Min. order quantity	Article Number	EAN Code
DCHXL 38*	38	1 ¼" UNC	420	490	1	1	4932399753	4002395364060
DCHXL 52	52	1 ¼" UNC	420	490	1	1	4932399163	4002395357703
DCHXL 68	68	1 ¼" UNC	420	490	1	1	4932399164	4002395357710
DCHXL 82	82	1 ¼" UNC	420	490	1	1	4932399165	4002395357727
DCHXL 102	102	1 ¼" UNC	420	490	1	1	4932399166	4002395357734
DCHXL 107	107	1 ¼" UNC	420	490	1	1	4932399754	4002395364077
① DCHXL 112	112	1 ¼" UNC	420	490	1	1	4932399167	4002395357741
DCHXL 117	117	1 ¼" UNC	420	490	1	1	4932399755	4002395364084
DCHXL 122	122	1 ¼" UNC	420	490	1	1	4932399168	4002395357758
DCHXL 127	127	1 ¼" UNC	420	490	1	1	4932399169	4002395357765
DCHXL 132	132	1 ¼" UNC	420	490	1	1	4932399170	4002395357772
DCHXL 152	152	1 ¼" UNC	420	490	1	1	4932399171	4002395357789
DCHXL 162	162	1 ¼" UNC	420	490	1	1	4932399172	4002395357796

* During pre-drilling no centering star required.

Description	Tool reception	Core reception	Pack quantity	Min. order quantity	Article Number	EAN Code
-------------	----------------	----------------	---------------	---------------------	----------------	----------

② FIXTEC[™] Clean Line Rotor (CLR) M18 x 2.5 1 ¼" UNC 1 1 4932352172 4002395368242

Description	Pack quantity	Min. order quantity	Article Number	EAN Code
-------------	---------------	---------------------	----------------	----------

③ Guide rod for DD2-160. Supplied with locking screw (4931622432). Requires allen key and SDS-plus pilot drill (Ø 8 x 160 mm) 1 1 4932399173 4002395357802

④ Guide rod for DD3-152. Requires SDS-plus pilot drill (Ø 8 x 110 mm) 1 1 4932352679 4002395373376

⑤ Dry drilling guide rod for MXF DCD150. 1 1 4932479580 4058546373740

Diameter (mm)	Article Number	EAN Code	Diameter (mm)	Article Number	EAN Code
52	4931393176	4002395358380	117	4931403508	4002395364107
68	4931393177	4002395358397	122	4931393181	4002395780709
82	4931393178	4002395358403	127	4931393182	4002395780716
⑥ 102	4931393179	4002395358410	132	4931393183	4002395358458
107	4931403507	4002395364091	152	4931393184	4002395358465
112	4931393180	4002395358427	162	4931393185	4002395358472

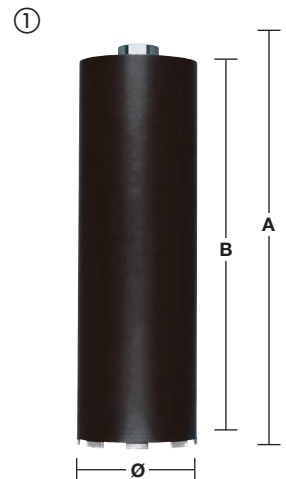

Dry diamond cores for electrical sockets with dust extraction - DCHX

10 mm high segments for longer life.
 Laser welded segments for extra durability.
 Suitable for installation of electrical sockets and junction boxes.
 Use with the machine set to rotary only, not suitable for hammer action.

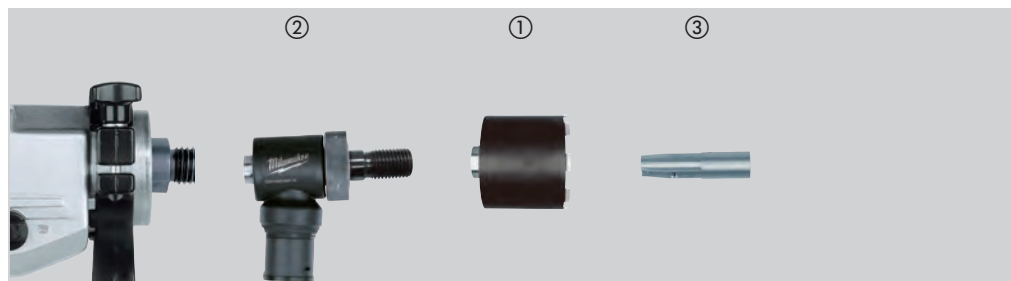

Material	DCHX	Material	DCHX
Aerated/breeze concrete blocks	◆	Granite	✘
Artificial stone – hard	✘	Lime/sandstone – hard	✓
Brick – very hard, engineering brick	✓	Lime/sandstone – soft/abrasive	◆
Brick – medium	✓	Marble	✘
Brick – soft	◆	Tiles	✘
Concrete	✘		

- ✓ Most suitable. Recommended for these materials.
- ◆ Limited suitability – recommended for intermittent use. Very good in drilling characteristics, but reduced lifetime.
- ✘ Not suitable. Not recommended for these materials.

Description	Diameter (mm)	Core reception	Working length (mm) B	Total length (mm) A	Pack quantity	Min. order quantity	Article Number	EAN Code
① DCHX 68	68	1 1/4" UNC	60	130	1	1	4932399217	4002395358311
DCHX 82	82	1 1/4" UNC	60	130	1	1	4932399218	4002395358328

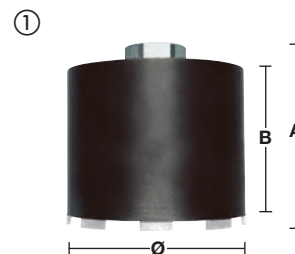

Description	Tool reception	Core reception	Pack quantity	Min. order quantity	Article Number	EAN Code
② FIXTEC™ Clean Line Rotor (CLR)	M18 x 2.5	1 1/4" UNC	1	1	4932352172	4002395368242



Description	Pack quantity	Min. order quantity	Article Number	EAN Code
Guide rod for DD2-160				
③ Supplied with locking screw (4931622432). Requires allen key (4931616044) and SDS-plus pilot drill bit (8 x 110 mm, 4932307070)	1	1	4932399221	4002395358359



Dry diamond drilling for electrical sockets without dust extraction - DCU / DCH

7 mm high segments.

Laser welded segments for extra durability.

Suitable for installation of electrical sockets and junction boxes.

Use with the machine set to rotary only, not suitable for hammer action.

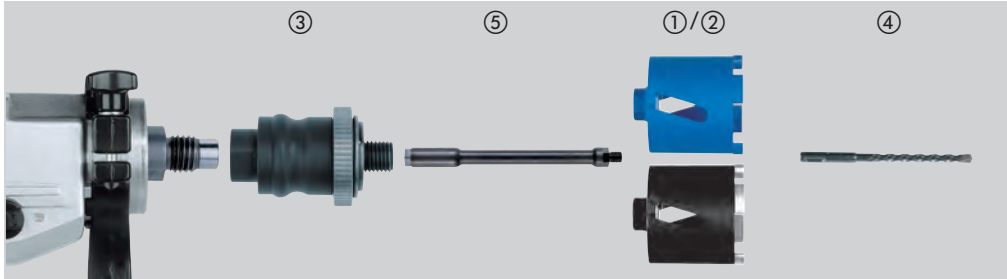

Material	DCU	DCH	Material	DCU	DCH
Aerated/breeze concrete blocks	◆	◆	Granite	✗	✗
Artificial stone – hard	✗	✗	Lime/sandstone – hard	◆	✓
Brick – very hard, engineering brick	◆	✓	Lime/sandstone – soft/abrasive	✓	◆
Brick – medium	✓	✓	Marble	✗	✗
Brick – soft	✓	◆	Tiles	✗	✗
Concrete	✗	✗			

- ✓ Most suitable. Recommended for these materials.
- ◆ Limited suitability – recommended for intermittent use. Very good in drilling characteristics, but reduced lifetime.
- ✗ Not suitable. Not recommended for these materials.

- ✓ Most suitable. Recommended for these materials.
- ◆ Limited suitability – recommended for intermittent use. Very good in drilling characteristics, but reduced lifetime.
- ✗ Not suitable. Not recommended for these materials.

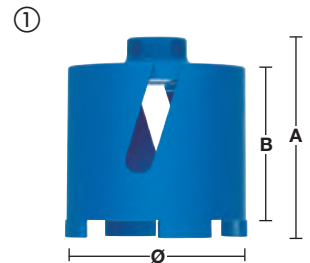

Description	Diameter (mm)	Core reception	Working length (mm) B	Total length (mm) A	Pack quantity	Min. order quantity	Article Number	EAN Code
① DCU 68	68	M16	60	90	1	1	4932371978	4002395346035
① DCU 82	82	M16	60	90	1	1	4932371979	4002395346042
② DCH 68	68	M16	60	90	1	1	4932399579	4002395362080
② DCH 82	82	M16	60	90	1	1	4932399580	4002395362097

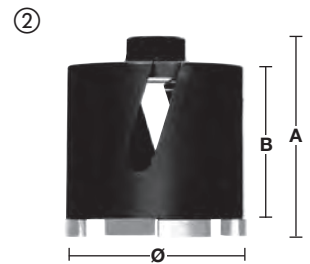

Description	Tool reception	Core reception	Pack quantity	Min. order quantity	Article Number	EAN Code
③ FIXTEC™ adaptor. Tool changing in seconds. No extra tool required	M18 x 2.5	M16	1	1	4932399174	4002395357819
	11 mm Hex	M16	1	1	4932399220	4002395358342
④ Requires SDS-plus pilot drill bit (Ø 8 x 160 mm)			1	1	4932307071	4002395308873



Description	Adaptor reception	Core reception	Total length (mm) A	Pack quantity	Min. order quantity	Article Number	EAN Code
⑤ Extension between FIXTEC adaptor and diamond core	M16	M16	300	1	1	4932369736	4002395346028



System attachments - Wet diamond drilling

Description	Fits DD3-152	Fits DCM2-250C & DCM2-350C	Fits MXF DCD150	Pack quantity	Min. order quantity	Article Number	EAN Code
<p>Fixing kit. For exclusive use in concrete. Ø 16 mm drill bit is required to set the drop anchor</p> <p>① Stud bolt, setting tool, wing nut, washer and 5 pcs M12 drop anchor</p>	✓	✓	✓	9	1	4932399731	4002395363827
<p>② 1 3/8" open ended spanner. For holding the motor output spindle while removing a core bit</p>		✓		1	1	49964705	045242222766
<p>③ Fixtec release. Suitable for all diamond motors with 1 1/4" spindle reception. Prevents the core bit from locking itself too tight onto the machine spindle. The core bits can then be released and removed with minimum effort</p>	✓	✓		1	1	4932352053	4002395367108
<p>④ 1 1/4" female to 1/2" female adaptor: To enable the connection of <50 mm diamond core bits on a 1 1/4" machine spindle thread</p>	✓	✓		1	1	4932352627	4002395372850
<p>⑤ 1 1/4" female / male extension rod, length 300 mm</p>	✓	✓	✓	1	1	4932399724	4002395363759
<p>⑤ 1 1/4" female / male extension rod, length 500 mm</p>	✓	✓	✓	1	1	4932399725	4002395363766
<p>⑥ Telescopic extension. Extension pole used to fix drill rig to the ground instead of anchor bolts. Maximum load of 500 kg and adjustable extension height from 1.8-2.9 m</p>	✓	✓	✓	1	1	4932399732	4002395363834
<p>⑦ Vacuum pump VP6</p>	✓	✓	✓	1	1	4932352094	4002395367474
<p>⑧ Vacuum plate. Replacement rubber seal 4931428665</p>	✓			1	1	4932352676	4002395373345
<p>⑨ WT 10 watertank</p>	✓	✓	✓	1	1	4932399726	4002395363773
<p>⑩ Water collection ring: For use with drill rig DR 152 T. For use with max. Ø 152 mm core bits</p>				1	1	4932352677	4002395373352
<p>Replacement rubber ring for DR 152 T</p>				1	1	4932352678	4002395373369
<p>⑪ Water collection ring: max. Ø 180 mm</p>			✓	1	1	4932399727	4002395363780
<p>Replacement rubber ring for DR 250 TV</p>			✓	1	1	4932399729	4002395363803
<p>⑫ Water collection ring: For use with drill rig DR 350 T. For use with max. Ø 300 mm core bits</p>				1	1	4932399728	4002395363797
<p>Replacement rubber ring for DR 350 T</p>				1	1	4932399730	4002395363810
<p>⑬ Spacer block T = 50 mm. Needs to be mouted between drill rig and motor cores > 250 mm and max. 350 mm. Included in drill rig DR 350 T</p>		✓		1	1	4932399736	4002395363872
<p>⑭ Quick connection motor mounting plate. Included in both drill rigs DR 250 TV and DR 350 T</p>		✓		1	1	4932399733	4002395363841
<p>⑮ Water collection ring: For universal use with diamond drilling tools. For use with max. Ø 152 mm core bits</p>	✓	✓	✓	1	1	4932478073	4058546340063
<p>⑯ Guide rod for DD3-152. Requires SDS-plus pilot drill (Ø 8 x 110 mm)</p>	✓	✓	✓	1	1	4932352679	4002395373376



Dry diamond drilling without dust extraction - DCH 150

10 mm high segments.

Laser welded segments for extra durability.

Use with the machine set to rotary only, not suitable for hammer action.

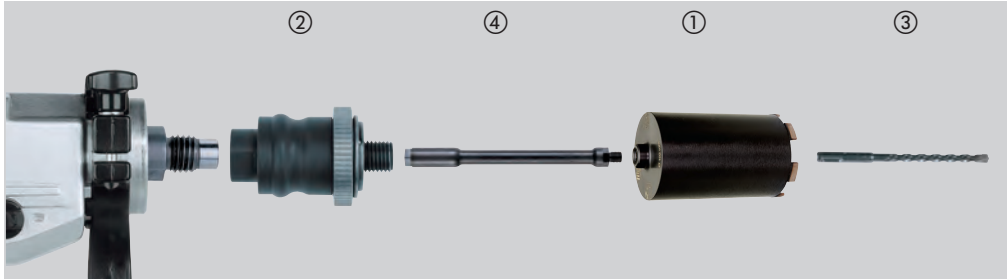

Material	DCH	Material	DCH
Aerated/breeze concrete blocks	◆	Granite	✘
Artificial stone – hard	✘	Lime/sandstone – hard	✓
Brick – very hard, engineering brick	✓	Lime/sandstone – soft/abrasive	◆
Brick – medium	✓	Marble	✘
Brick – soft	◆	Tiles	✘
Concrete	✘		

- ✓ Most suitable. Recommended for these materials.
- ◆ Limited suitability – recommended for intermittent use. Very good in drilling characteristics, but reduced lifetime.
- ✘ Not suitable. Not recommended for these materials.

- ✓ Most suitable. Recommended for these materials.
- ◆ Limited suitability – recommended for intermittent use. Very good in drilling characteristics, but reduced lifetime.
- ✘ Not suitable. Not recommended for these materials.

Description	Diameter (mm)	Core reception	Working length (mm) B	Total length (mm) A	Pack quantity	Min. order quantity	Article Number	EAN Code
DCH 150-52	52	M16	150	180	1	1	4932352628	4002395372867
DCH 150-62	62	M16	150	180	1	1	4932352629	4002395372874
DCH 150-68	68	M16	150	180	1	1	4932352630	4002395372881
DCH 150-82	82	M16	150	180	1	1	4932352631	4002395372898
DCH 150-102	102	M16	150	180	1	1	4932352632	4002395372904
DCH 150-127	127	M16	150	180	1	1	4932352633	4002395372911

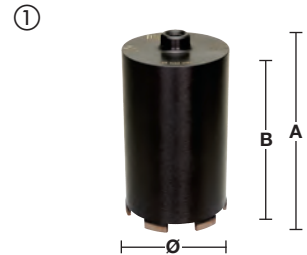

Description	Tool reception	Core reception	Pack quantity	Min. order quantity	Article Number	EAN Code
FIXTEC [™] adaptor. Tool changing in seconds. No extra tool required	M18 x 2.5	M16	1	1	4932399174	4002395357819
	11 mm Hex	M16	1	1	4932399220	4002395358342
Requires SDS-plus pilot drill bit (Ø 8 x 260 mm)			1	1	4932353821	4002395320141

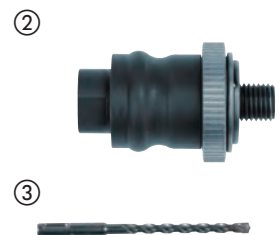

Description	Adaptor reception	Core reception	Total length (mm) A	Pack quantity	Min. order quantity	Article Number	EAN Code
Extension between FIXTEC adaptor and diamond core	M16	M16	300	1	1	4932369736	4002395346028

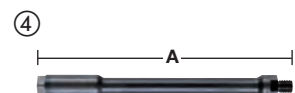

SHOCKWAVE 
IMPACT DUTY TM

DRIVING PERFORMANCE FORWARD

SHOCKWAVE™ IMPACT DRIVER BITS

FASTENING



**WEAR
 GUARD
 TIP™**

Scan the QR Code to see our full video.



**CUSTOM
 ALLOY 76™
 STEEL**



**OPTIMIZED
 SHOCK ZONE™**

MILWAUKEE® SHOCKWAVE™ IMPACT DUTY driver bits are engineered to be the most durable, best fitting driver bits on the market. The WEAR GUARD TIP™ is laser hardened to create an outer shield that protects the fit over the life of the bit. The SHOCK ZONE™ is optimized for each tip type and length of driver bit, absorbing peak torque and preventing breaking. The customized CUSTOM ALLOY 76™ steel and heat treatment for each tip type is engineered to ensure best performance across tip types and extended life vs. standard bits. The SHOCKWAVE™ impact driver bits provide extreme durability for the most demanding job site applications.



SHOCKWAVE™ IMPACT DUTY screwdriving bits

IMPACT

Designed for use with impact drivers the SHOCKWAVE™ IMPACT DUTY accessory line is not only ideal for heavy duty impact applications, but also delivers a full system solution for all the user's drilling and fastening needs.

Laser hardened WEAR GUARD TIP™ for improved wear resistance and protection of the fit over the life of the bit.



SHOCK ZONE™ Geometry - designed to flex:

SHOCK ZONE™ reduces stress at the tip resulting in less tip breakages. The combination of the SHOCK ZONE™ design and special heat treatment absorbs impacts and allows the bit to flex with spring like action.

Custom engineered steel - MILWAUKEE® custom metal formula makes the SHOCKWAVE™ bits more resistant to shock from impacting.



- A) 25 mm 1/4" Hex - DIN 3126 - C 6.3
- B) 50 mm 1/4" Hex - DIN 3126 - E 6.3
- C) 90 mm 1/4" Hex - DIN 3126 - E 6.3
- D) 150 mm 1/4" Hex - DIN 3126 - E 6.3

Type	Total length (mm)	Supplied in	Pack quantity	Min. order quantity	Article Number	EAN Code
Philips 	PH 1	25	①	2	1	4932430850 4002395385126
		50	①	1	1	4932471564 4058546294632
		90	①	1	1	4932430851 4002395385133
	PH 2	25	①	2	1	4932430852 4002395385140
		25	②	25	10	4932430853 4002395385157
		50	①	1	1	4932430854 4002395385164
		50	②	10	10	4932430855 4002395385171
		90	①	1	1	4932430856 4002395385188
		150	①	1	1	4932471565 4058546294649
	PH 3	25	①	2	1	4932430857 4002395385195
		50	①	1	1	4932430858 4002395385201
		90	①	1	1	4932430859 4002395385218
PoziDrive 	PZ 1	25	①	2	1	4932430860 4002395385225
		25	②	25	10	4932430861 4002395385232
		50	①	1	1	4932471566 4058546294656
		90	①	1	1	4932430862 4002395385249
	PZ 2	25	①	2	1	4932430863 4002395385256
		25	②	25	10	4932430864 4002395385263
		50	①	1	1	4932430865 4002395385270
		50	②	10	10	4932430866 4002395385287
		90	①	1	1	4932430867 4002395385294
	PZ 3	150	①	1	1	4932471928 4058546298272
		25	①	2	1	4932430868 4002395385300
		25	②	25	10	4932430869 4002395385317
50		①	1	1	4932430870 4002395385324	
	150	①	1	1	4932471929 4058546298289	

① Blister



② Storage container



Minimum order quantity = 10 pcs (come in counter display) orders. > 10 pcs must be ordered in multiples of 10 (i.e. 10,20,30)

③ Counter display



SHOCKWAVE TM

IMPACT DUTY



Type	Total length (mm)	Supplied in	Pack quantity	Min. order quantity	Article Number	EAN Code	
TORX®	TX 7	25	①	2	1	4932471567	4058546294663
	TX 8	25	①	2	1	4932471568	4058546294670
	TX 9	25	①	2	1	4932471569	4058546294687
	TX 10	25	①	2	1	4932430871	4002395385331
		50	①	1	1	4932471570	4058546294694
	TX 15	25	①	2	1	4932430872	4002395385348
		25	②	25	10	4932430873	4002395385355
		50	①	1	1	4932451286	4002395157440
		90	①	1	1	4932471571	4058546294700
		150	①	1	1	4932471572	4058546294717
	TX 20	25	①	2	1	4932430874	4002395385362
		25	②	25	10	4932430875	4002395385379
		50	①	1	1	4932430876	4002395385386
		50	②	10	10	4932430877	4002395385393
		90	①	1	1	4932430878	4002395385409
		150	①	1	1	4932471573	4058546294724
	TX 25	25	①	2	1	4932430879	4002395385416
		25	②	25	10	4932430880	4002395385423
		50	①	1	1	4932430881	4002395385430
		50	②	10	10	4932430882	4002395385447
		90	①	1	1	4932430883	4002395385454
	TX 27	25	①	2	1	4932430884	4002395385461
	TX 30	25	①	2	1	4932430885	4002395385478
		25	②	25	10	4932430886	4002395385485
		50	①	1	1	4932430887	4002395385492
		50	②	10	10	4932471574	4058546294731
		90	①	1	1	4932471575	4058546294748
	TX 40	25	①	2	1	4932430888	4002395385508
		25	②	25	10	4932430889	4002395385515
		50	①	1	1	4932430890	4002395385522
	TX 50	25	①	2	1	4932430891	4002395385539
		25	②	15	10	4932430892	4002395385546

① Blister



② Storage container



Minimum order quantity = 10 pcs (come in counter display) orders. > 10 pcs must be ordered in multiples of 10 (i.e. 10,20,30)

③ Counter display



SHOCKWAVE TM

IMPACT DUTY

	Type	Total length (mm)	Supplied in	Pack quantity	Min. order quantity	Article Number	EAN Code
	TORX® B0 TX B07	25	①	2	1	4932471577	4058546294762
	TX B08	25	①	2	1	4932471578	4058546294779
	TX B09	25	①	2	1	4932471579	4058546294786
	TX B010	25	①	2	1	4932471580	4058546294793
	TX B015	25	①	2	1	4932471581	4058546294809
	TX B020	25	①	2	1	4932471582	4058546294816
	TX B025	25	①	2	1	4932471583	4058546294823
	TX B030	25	①	2	1	4932471584	4058546294830
	TX B040	25	①	2	1	4932471585	4058546294847
	Hex	Hex 2.5 mm	25	①	2	1	4932430893
Hex 3 mm		25	①	2	1	4932430894	4002395385560
Hex 4 mm		25	①	2	1	4932430895	4002395385577
Hex 5 mm		25	①	2	1	4932430896	4002395385584
Hex 6 mm		25	①	2	1	4932430897	4002395385591
Hex 8 mm		25	①	2	1	4932430898	4002395385607
Hex 10 mm		25	①	2	1	4932430899	4002395385614
Hex 12 mm		25	①	2	1	4932430900	4002395385621
Slotted	SL 0.6 x 4.5	25	①	2	1	4932430901	4002395385638
	SL 0.8 x 5.5	25	①	2	1	4932430902	4002395385645
	SL 1.2 x 6.5	25	①	2	1	4932430903	4002395385652

① Blister



SHOCKWAVE™ IMPACT DUTY ™

SHOCKWAVE™ IMPACT DUTY sets

Description	Pack quantity	Min. order quantity	Article Number	EAN Code
SHOCKWAVE™ IMPACT DUTY Carabiner Set 1 (10 pc) SHOCKWAVE™ screwdriving bits: 10 x 50mm length: 2 x PH2 / 1 x PZ2 / 1 x TX15 / 2 x TX20 / 2 x TX25 / 1 x TX30 / 1 x TX40	10	50	4932480941	4058546412265
SHOCKWAVE™ IMPACT DUTY Carabiner Set 2 (10 pc) Shockwave™ Impact Rated Screwdriving Bits: 10 x 50mm length: 4 x PH2 / 4 x PZ2 / 1 x TX20 / 1 x TX25			4932492939	4058546478100
SHOCKWAVE™ IMPACT DUTY puck bit set (15 pc) SHOCKWAVE™ screwdriving bits: 14 x 25 mm length: 1 x PH1 / 2 x PH2, 1 x PZ1 / 2 x PZ2 / 1 x PZ3, 1 x TX10 / 2 x TX15 / 2 x TX20 / 1 x TX25 / 1 x TX30, 1 x SHOCKWAVE™ magnetic bit holder 60 mm length	15	10	4932430904	4002395385669
SHOCKWAVE™ IMPACT DUTY bit set (32 pc) SHOCKWAVE™ screwdriving bits: 31 x 25 mm length: 1 x PH1 / 2 x PH2 / 1 x PH3, 1 x PZ1 / 2 x PZ2 / 1 x PZ3, 2 x TX10 / 2 x TX15 / 3 x TX20 / 2 x TX25 / 2 x TX30 / 1 x TX40, 1 x TX B07 / 1 x TX B08 / 1 x TX B09 / 1 x TX B010 / 1 x TX B015 / 1 x TX B020 / 1 x TX B025, 1 x Hex 3 mm / 1 x Hex 4 mm / 1 x Hex 5 mm / 1 x Hex 6 mm. 1 x SHOCKWAVE™ locking bit holder 1/2" Hex reception 73 mm long	32	12	4932464240	4058546221850
SHOCKWAVE™ IMPACT DUTY TX bit set (32 pc) SHOCKWAVE™ TX screwdriving bits: 31 x 25 mm length: 2 x TX10 / 4 x TX15 / 5 x TX20 / 5 x TX25 / 5 x TX30 / 2 x TX40 / 1 x TX50, 1 x TX B07 / 1 x TX B08 / 1 x TX B09 / 1 x TX B010 / 1 x TX B015 / 1 x TX B020 / 1 x TX B025, 1 x SHOCKWAVE™ locking bit holder 1/2" Hex reception 73 mm long	32	12	4932471586	4058546294854
SHOCKWAVE™ IMPACT DUTY bit set (33 pc) SHOCKWAVE™ screwdriving bits: 24 x 25 mm length 1 x PH1 / 2 x PH2 / 1 x PH3, 2 x PZ1 / 3 x PZ2 / 2 x PZ3, 2 x TX10 / 2 x TX15 / 3 x TX20 / 2 x TX25 / 2 x TX30 / 1 x TX40 / 1 x TX50, 5 x 50 mm length 1 x PH2 / 1 x PZ2, 1 x TX15 / 1 x TX20 / 1 x TX25. 3 x SHOCKWAVE™ magnetic nut drivers: 48 mm length 1 x Hex 7 mm / 1 x Hex 8 mm / 1 x Hex 10 mm. 1 x SHOCKWAVE™ magnetic bit holder 60 mm length	33	6	4932492003	4058546413705
SHOCKWAVE™ IMPACT DUTY bit set (38 pc) SHOCKWAVE™ screwdriving bits: 16 x 25 mm length 1 x PH1 / 2 x PH2, 1 x PZ1 / 2 x PZ2, 1 x TX10 / 1 x TX15 / 2 x TX20 / 3 x TX25 / 2 x TX30 / 1 x TX40. 21 x 50 mm length 1 x PH1 / 3 x PH2 / 1 x PH3, 1 x PZ1 / 3 x PZ2 / 1 x PZ3, 1 x TX10 / 1 x TX15 / 1 x TX20 / 2 x TX25 / 3 x TX30 / 3 x TX40. 1 x SHOCKWAVE™ magnetic bit holder 60 mm length	38	6	4932492009	4058546413767
SHOCKWAVE™ IMPACT DUTY bit set (40 pc) SHOCKWAVE™ screwdriving bits: 25 x 25 mm length 1 x PH1 / 2 x PH2, 1 x PZ1 / 3 x PZ2, 2 x TX10 / 2 x TX15 / 3 x TX20 / 2 x TX25 / 2 x TX30 / 1 x TX40 / 1 x TX50, 1 x Hex 4 mm / 1 x Hex 5 mm, 1 x SL 0.6 x 4.5 / 1 x SL 0.8 x 5.5 / 1 x SL 1.2 x 6.5. 8 x 50 mm length 1 x PH2, 1 x PZ1 / 1 x PZ2, 1 x TX10 / 1 x TX15 / 1 x TX20 / 1 x TX25 / 1 x TX30. SHOCKWAVE™ magnetic bit holder: 1 x 60 mm length, 1 x 152 mm length. 3 x SHOCKWAVE™ 1/2" Hex drill bits: Ø 3 / 4 / 5 mm. 2 x SHOCKWAVE™ magnetic nut drivers: 48 mm length 1 x Hex 8 mm / 1 x Hex 10 mm	40	6	4932492004	4058546413712



SHOCKWAVE™ IMPACT DUTY sets

Description	Pack quantity	Min. order quantity	Article Number	EAN Code
<p>SHOCKWAVE™ IMPACT DUTY bit set (48 pc)</p> <p>SHOCKWAVE™ screwdriving bits: 24 x 25 mm length 1 x PH1 / 3 x PH2 / 1 x PH3, 1 x PZ1 / 3 x PZ2 / 1 x PZ3, 2 x TX10 / 1 x TX15 / 3 x TX20 / 3 x TX25 / 2 x TX30 / 1 x TX40, 1 x Hex 4 mm / 1 x Hex 5 mm. 16 x 50 mm length 2 x PH2 / 1 x PH3, 2 x TX20 / 1 x PZ3, 1 x TX10 / 1 x TX15 / 2 x TX20 / 2 x TX25 / 2 x TX30 / 2 x TX40. 4 x 90 mm length 1 x PH2, 1 x PZ2, 1 x TX20 / 1 x TX25, 1 x SHOCKWAVE™ magnetic bit holder 60 mm length. 3 x SHOCKWAVE™ 1/4" Hex multi - material drill bits: Ø 5 / 6 / 8 mm</p>	48	6	4932492005	4058546413729
<p>SHOCKWAVE™ IMPACT DUTY bit set (56 pc)</p> <p>SHOCKWAVE™ screwdriving bits: 48 x 25 mm length 2 x PH1 / 3 x PH2 / 1 x PH3, 3 x PZ1 / 4 x PZ2 / 2 x PZ3, 3 x TX10 / 3 x TX15 / 4 x TX20 / 4 x TX25 / 4 x TX30 / 3 x TX40 / 2 x TX50, 2 x Hex 4 mm / 2 x Hex 5 mm, 2 x SL 0.6 x 4.5 / 2 x SL 0.8 x 5.5 / 2 x SL 1.2 x 6.5, 7 x 50 mm length 1 x PH2, 1 x PZ1 / 1 x PZ2, 1 x TX10 / 1 x TX15 / 1 x TX20 / 1 x TX25. 1 x SHOCKWAVE™ magnetic bit holder 60 mm length</p>	56	6	4932492006	4058546413736
<p>SHOCKWAVE™ IMPACT DUTY bit set (70 pc)</p> <p>SHOCKWAVE™ screwdriving bits: 48 x 25 mm length 1 x PH1 / 2 x PH2, 3 x PZ1 / 24 x PZ2 / 5 x PZ3, 1 x TX10 / 1 x TX15 / 2 x TX20 / 2 x TX25 / 2 x TX30 / 1 x TX40, 2 x Hex 4 mm / 2 x Hex 5 mm. 19 x 50 mm length 1 x PH1 / 3 x PH2, 1 x PZ1 / 5 x PZ2 / 3 x PZ3, 1 x TX20 / 1 x TX25 / 2 x TX30 / 2 x TX40. 2 x SHOCKWAVE™ nut drivers 48 mm length: Hex 8 mm / Hex 10 mm. 1 x SHOCKWAVE™ magnetic bit holder 60 mm length</p>	70	6	4932492007	4058546413743
<p>SHOCKWAVE™ IMPACT DUTY XL TX bit set (75 pc)</p> <p>SHOCKWAVE™ screwdriving bits: 60 x 25 mm length 1 x PH1 / 2 x PH2, 1 x PZ1 / 3 x PZ2 / 1 x PZ3, 2 x TX10 / 4 x TX15 / 12 x TX20 / 12 x TX25 / 12 x TX30 / 2 x TX40 / 1 x TX50, 1 x TX B07 / 1 x TX B08 / 1 x TX B09 / 1 x TX B010 / 1 x TX B015, 1 x Hex 4 mm / 1 x Hex 5 mm. 12 x 50 mm length 1 x PH2, 1 x PZ1 / 1 x PZ2, 1 x TX10 / 2 x TX15 / 2 x TX20 / 2 x TX25 / 2 x TX30. 2 x SHOCKWAVE™ nut drivers 48 mm length: Hex 8 mm / Hex 10 mm. 1 x SHOCKWAVE™ magnetic bit holder 60 mm length</p>	75	6	4932492008	4058546413750



SHOCKWAVE™ **IMPACT DUTY** ™

SHOCKWAVE™ Impact Duty drive guide cassettes

Slimline pocket design.

Drive guide bit holder with extendable sleeve to hold long screws secure. Up to 110 mm total length.

Front loading screwdriver handle.

Metal wire stripper for Ø 0.75 / 1.0 / 1.5 / 2.5 mm².

Wire loop maker up to 5 mm².



Description	Pack quantity	Min. order quantity	Article Number	EAN Code
SHOCKWAVE™ IMPACT DUTY drive guide set (12pc)				
1 x PH2, 1 x PZ1 / 2 x PZ2 / 1 x PZ3, 1 x TX15 / 1 x TX20 / 2 x TX25 / 1 x TX30 / 1 x TX40, 1 x drive guide bit holder 76 mm length	12	10	4932430910	4002395385720

SHOCKWAVE™ IMPACT DUTY magnetic bit holder

Custom engineered steel and heat treatment for maximum strength and flexibility.

Optimised SHOCK ZONE™ absorbs up to 3X more torque for more resistance to shock from impacting.

Strong magnetic tip for secure grip.

1/4" Hex reception (DIN 3126 - E 6.3). Very suitable for high torque and impact applications.

Description	Total length (mm) A	Pack quantity	Min. order quantity	Article Number	EAN Code
① Magnetic bit holder 60 mm	60	1	1	4932352406	4002395370658
② Magnetic bit holder 60 mm - jam jar (100pc)	60	1	100	4932430478	4002395381395
③ Magnetic bit holder 152 mm - long series	152	1	1	4932471822	4058546297213
④ Magnetic bit holder 305 mm - long series	305	1	1	4932471823	4058546297220

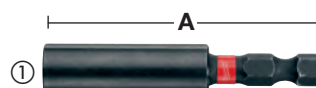



SHOCKWAVE™ IMPACT DUTY locking bit holder

Dual internal magnets ensure magnetism to fasteners.

Auto-Locking - One handed bit release.

1/4" Hex reception (DIN 3126 - E 6.3). Very suitable for high torque and impact applications.

Description	Total length (mm) A	Pack quantity	Min. order quantity	Article Number	EAN Code
① Locking bit holder 73 mm	73	1	1	4932459398	4058546010591
② Locking bit holder 152 mm - long series	152	1	1	4932471824	4058546297237
③ Locking bit holder 305 mm - long series	305	1	1	4932471825	4058546297244

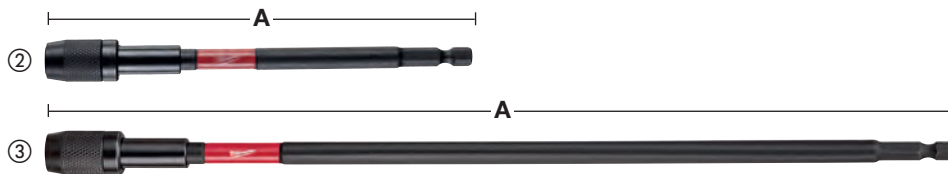
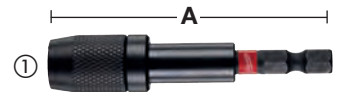

SHOCKWAVE™ IMPACT DUTY socket adaptors - Hex reception

Description	Total length (mm) A	Pack quantity	Min. order quantity	Article Number	EAN Code
① Socket adaptor: 1/4" Hex - 1/4" square. DIN 3126 - E 6.3	50	1	1	4932471826	4058546297251
② Socket adaptor: 1/4" Hex - 3/8" square. DIN 3126 - E 6.3	50	1	1	4932478054	4058546339876
③ Socket adaptor: 1/4" Hex - 1/2" square. DIN 3126 - E 6.3	50	1	1	4932478803	4058546360856
④ Socket adaptor: 7/16" Hex - 1/2" square	70	1	1	4932480586	4058546408718
SHOCKWAVE™ IMPACT DUTY socket adaptor set (3pc)		3	1	4932479228	4058546370220
⑤ 1 x 1/4" Hex - 1/4" square, 1 x 1/4" Hex - 3/8" square, 1 x 1/4" Hex - 1/2" square					



SHOCKWAVE™ IMPACT DUTY magnetic nut drivers

Custom engineered steel and heat treatment for maximum strength and extreme durability.

Strong magnetic tip for secure grip.

1/4" Hex reception (DIN 3126 - E 6.3). Very suitable for high torque and impact applications.

Size AF (across flats) (mm)	For anchor thread size	Total length (mm)	Pack quantity	Min. order quantity	Article Number	EAN Code
5.5	M3	65	1	1	4932492434	4058546418014
6	M3.5	65	1	1	4932492435	4058546418021
1/4"	-	65	1	1	4932492436	4058546418038
7	M4	65	1	1	4932492437	4058546418045
5/16"	-	65	1	1	4932492438	4058546418052
8	M5	65	1	1	4932492439	4058546418069
8	M5	150	1	1	4932492446	4058546418137
3/8"	-	65	1	1	4932492440	4058546418076
10	M6	65	1	1	4932492441	4058546418083
10	M6	150	1	1	4932492447	4058546418144
12	M7	65	1	1	4932492442	4058546418090
13	M8	65	1	1	4932492443	4058546418106
13	M8	150	1	1	4932492448	4058546418151
17	M10	65	1	1	4932492444	4058546418113



SHOCKWAVE™ IMPACT DUTY magnetic nut driver set (4pc)
 4 4932492445 4058546418120
 Ø 7 / 8 / 10 / 13 mm

SHOCKWAVE™ **IMPACT DUTY**

SHOCKWAVE™ right angle attachment

The right angle attachment is a useful device for screwdriving or drilling applications in restricted, difficult to reach areas.

Impact rated: suitable to use with latest 18V impact drivers as well as cordless drill drivers.

Internal SHOCK ZONE™ and advanced gear design for excellent power transmission and impact durability.

For all 1/4" Hex driving and drilling accessories.

Very compact design: only 36 mm in height and a true 90° angle to allow access into confined spaces.

Ergonomic rubber overmold for secure and comfortable handling.

Pack contains 1 x right angle attachment and 10 x 25 mm screwdriving bits.

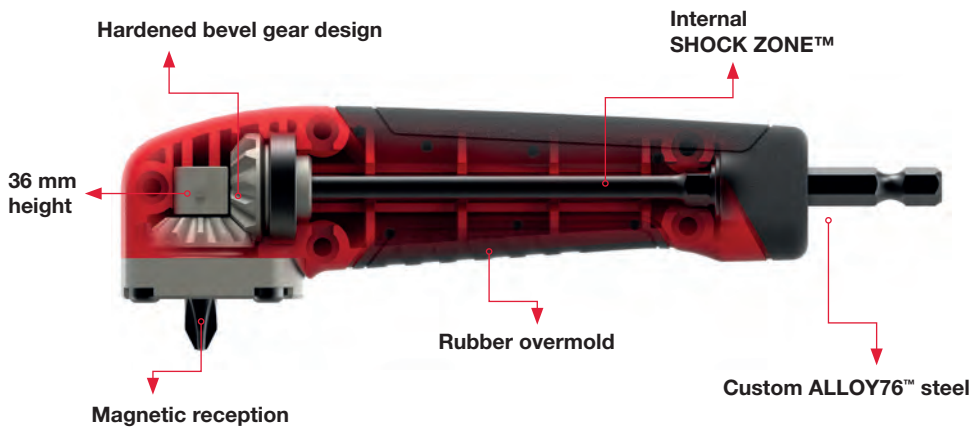

Description	Pack quantity	Min. order quantity	Article Number	EAN Code
Counter display SHOCKWAVE™ Right Angle Attachment set (11pc)	11	12	4932471274	4058546289027
1 x Right Angle Attachment, 1 x PH2, 1 x PZ1 / 2 x PZ2 / 1 x PZ3, 1 x TX10 / 1 x TX15 / 1 x TX20 / 1 x TX25 / 1 x TX30				



SHOCKWAVE™ **KNUCKLE™** offset attachment

Impact rated: suitable to use with latest 18V impact drivers as well as cordless drill drivers.

Very compact offset attachment.

Ideally suited to working in confined and limited spaces.

Solid metal construction to absorb impact action.

0° and 30° positions.

1/4" Hex shank fits directly into the chuck preventing slippage.

* Height when 30° tilted 40 mm



* Height when 30° tilted 40 mm



Description	Pack quantity	Min. order quantity	Article Number	EAN Code
Counter display KNUCKLE™ set (11pc)	11	10	4932459781	4058546029531
1 x KNUCKLE™, 1 x PH1 / 2 x PH2, 1 x PZ1 / 2 x PZ2 / 1 x PZ3, 1 x TX15 / 1 x TX20 / 1 x TX25				

OSD2 - Offset screwdriver/ drill angle attachment

The OSD 2 screwdriver / drill angle attachment is the ideal solution for all screwdriving and drilling applications in restricted areas. 1/4" magnetic Hex bit reception accepts both standard 25 mm (C 6.3) and ball end reception (E 6.3), with bit locking mechanism. Metal gears and housing for smooth and precise running and excellent power transmission. 360° rotatable softgrip side handel for left and right hand use with 4 lock positions. Two step Hex shaft to fit either 1/4" (6 mm) Hex shaft or 10 mm Hex shaft. Industrial quality designed for use with all cordless tools in applications up to 40 Nm torque and a maximum of 1750 rpm. The OSD2 is capable of both drilling and screwdriving applications, offering maximum versatility. Only 51 mm in height for use in confined spaces.



Description	Pack quantity	Min. order quantity	Article Number	EAN Code
① OSD 2	1	1	4932352320	4002395369799
② Counter display	6	1	4932352321	4002395369805
6 x OSD 2 (4932352320)				

Screwdriving bits



The ribs are cold formed to exact specification ensuring reduced wear from slippage. The tip is subjected to a special hardening process with temperatures up to 870°C. The outcome is a bit with a hardness of 60 HRC. This extra hard tip ensures extra long life under constant use. The body is manufactured from the highest quality S2 european steel. The sign of quality: All bits are laser marked with the MILWAUKEE® logo and tip reception for easy identification.

	Type	Total length (mm)	Pack quantity	Min. order quantity	Article Number	EAN Code
	PH 1	25	25	1	4932399586	4002395362363
	PH 2	25	25	1	4932399587	4002395362370
	PH 3	25	25	1	4932399588	4002395362387
	PZ 1	25	25	1	4932399589	4002395362394
	PZ 2	25	25	1	4932399590	4002395362400
	PZ 3	25	25	1	4932399591	4002395362417
	TX 10	25	25	1	4932399594	4002395362448
	TX 15	25	25	1	4932399595	4002395362455
	TX 20	25	25	1	4932399596	4002395362462
	TX 25	25	25	1	4932399597	4002395362479
	TX 30	25	25	1	4932399599	4002395362493
	TX 40	25	25	1	4932399600	4002395362509

Screwdriving bit cassettes

This high quality cassette aimed at the professional user is available in 3 different assortments.

Slimline pocket design: 110 mm x 65 mm x 15 mm.

Secure latch system - easy opening and safe closing.

Extra side compartment accepts either 50 mm screwdriving bits or drill bits.

Front window to protect bits from dust.

High quality screwdriving bits with hardness of 60 HRC and 1/4" Hex reception. 25 mm bits manufactured according to DIN 3126 - C 6.3. 50 mm bits are manufactured according to DIN 3126 - E 6.3.

Magnetic bit holder with quick release clutch.

Description	Pack quantity	Min. order quantity	Article Number	EAN Code
Compact screwdriving bit set (12pc) 25 mm: SL 0.8 x 5.5 mm x 1. 25 mm: PH 1 x 1 / PH 2 x 2 / PH 3 x 1. 25 mm: PZ 1 x 1 / PZ 2 x 2 / PZ 3 x 1. 50 mm: PH 2 x 1. 50 mm: PZ 2 x 1. Magnetic bit holder with quick release clutch	12	1	4932399513	4002395361601



Screwdriving bits sets

Description	Pack quantity	Min. order quantity	Article Number	EAN Code
Screwdriving bit set (35pc) Screwdriving bits 25 mm length: PH 1 x 2 / PH 2 x 3 / PH 3 x 2. PZ 1 x 2 / PZ 2 x 3 / PZ 3 x 2. TX 10 x 2 / TX 15 x 2 / TX 20 x 3. TX 25 x 3 / TX 30 x 2 / TX 40 x 2. Screwdriving bits 50 mm length: PH 1 x 1 / PH 2 x 1. PZ 1 x 1 / PZ 2 x 1. TX 20 x 1 / TX 25 x 1. 1 x magnetic bit holder with 1/4" Hex reception	35	6	4932352068*	4002395367214
Screwdriving bit set (27pc) Screwdriving bits 25 mm length: PH 1 x 2 / PH 2 x 2 / PH 3 x 1. PZ 1 x 2 / PZ 2 x 4 / PZ 3 x 2. TX 10 x 2 / TX 15 x 3 / TX 20 x 3. TX 25 x 3 / TX 30 x 1 / TX 40 x 1. Magnetic bit holder with quick release clutch.	27	1	4932352747	4002395374052



Magnetic bit holders

Description	Pack quantity	Min. order quantity	Article Number	EAN Code
① Magnetic bit holder with quick release clutch, total length 58 mm	1	1	4932373483	4002395351060
② Magnetic bit holder for drywall	1	1	4932430179	4002395378401





Nothing but **HEAVY DUTY.**[™]

NEXT GENERATION **SHOCKWAVE** IMPACT SOCKETS

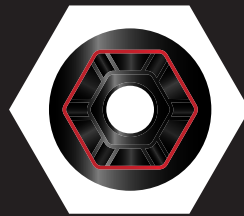

**6 POINT
HEX GEOMETRY**



**STAMPED
AND INK
FILLED SIZES**

SHOCKWAVE

IMPACT DUTY 



FASTENING

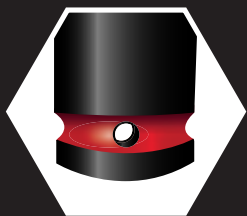

DUAL HOLE
DESIGN FOR EASIER
ATTACHMENT



LASER-ETCHED
LOGO & PART NUMBER

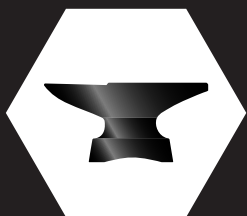

FORGED
HIGH TORQUE
IMPACT STEEL

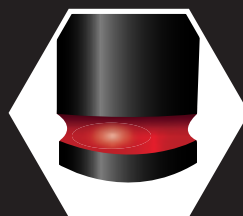

COLOUR
BAND
INK FILLED



1/4" SHOCKWAVE™ IMPACT DUTY impact sockets - deep

A (mm)	B (mm)	C (mm)	D (mm)	E (mm)	For anchor thread size	Pack quantity	Min. order quantity	Article Number	EAN Code
1/4" square	4	50	1.9	7.60	M2	1	1	4932480251	4058546405366
1/4" square	4.5	50	2.2	8	-	1	1	4932480252	4058546405373
1/4" square	5	50	2.8	8	M2.5	1	1	4932480253	4058546405380
1/4" square	5.5	50	2.8	8.5	M3	1	1	4932480254	4058546405397
1/4" square	6	50	3.1	9.6	M3.5	1	1	4932480255	4058546405403
1/4" square	7	50	3.6	10.8	M4	1	1	4932480256	4058546405410
1/4" square	8	50	3.6	12	M5	1	1	4932480257	4058546405427
1/4" square	9	50	4.1	13	-	1	1	4932480258	4058546405434
1/4" square	10	50	4.6	13.8	M6	1	1	4932480259	4058546405441
1/4" square	11	50	5.5	13.8	-	1	1	4932480260	4058546405458
1/4" square	12	50	6.1	14.7	M7	1	1	4932480261	4058546405465
1/4" square	13	50	6.8	15.7	M8	1	1	4932480262	4058546405472
1/4" SHOCKWAVE™ IMPACT DUTY socket rail set (12pc)									
12 x 1/4" sockets: 4 / 4.5 / 5 / 5.5 / 6 / 7 / 8 / 9 / 10 / 11 / 12 / 13 and socket rail						12	1	4932480453	4058546407384

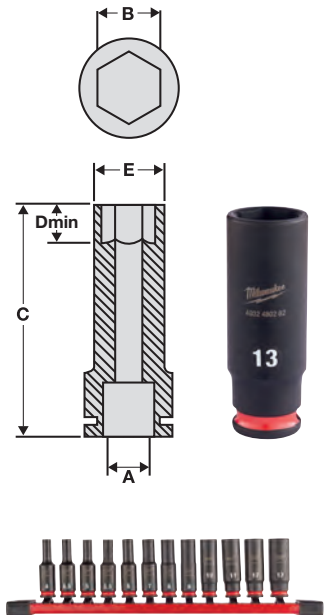

SHOCKWAVE™ IMPACT DUTY



TM

3/8" SHOCKWAVE™ IMPACT DUTY impact sockets - standard

A (mm)	B (mm)	C (mm)	D (mm)	E (mm)	For anchor thread size	Pack quantity	Min. order quantity	Article Number	EAN Code
3/8" square	6	32	3.1	10.5	M3.5	1	1	4932480263	4058546405489
3/8" square	7	32	3.1	12.6	M4	1	1	4932480264	4058546405496
3/8" square	8	32	3.6	13.9	M5	1	1	4932480265	4058546405502
3/8" square	9	32	4.1	14.5	-	1	1	4932480266	4058546405519
3/8" square	10	32	4.6	15.8	M6	1	1	4932480267	4058546405526
3/8" square	11	32	5.5	16.9	-	1	1	4932480268	4058546405533
3/8" square	12	32	6.1	18.2	M7	1	1	4932480269	4058546405540
3/8" square	13	32	6.8	19.5	M8	1	1	4932480270	4058546405557
3/8" square	14	32	8.4	20.5	-	1	1	4932480271	4058546405564
3/8" square	15	32	8.4	21.8	-	1	1	4932480272	4058546405571
3/8" square	16	32	9.6	23.8	M10	1	1	4932480273	4058546405588
3/8" square	17	34	9.6	24.8	-	1	1	4932480274	4058546405595
3/8" square	18	34	10.2	25.8	M12	1	1	4932480275	4058546405601
3/8" square	19	34	11	27.6	-	1	1	4932480276	4058546405618
3/8" square	20	34	11	27.8	-	1	1	4932480277	4058546405625
3/8" square	21	34	11.7	29.8	M14	1	1	4932480278	4058546405632
3/8" square	22	34	12.5	31.6	-	1	1	4932480279	4058546405649
3/8" SHOCKWAVE™ IMPACT DUTY socket standard rail set (9pc)						9	1	4932480454	4058546407391
8 x impact standard sockets: 8 / 10 / 12 / 13 / 16 / 17 / 18 / 19 mm and socket rail									

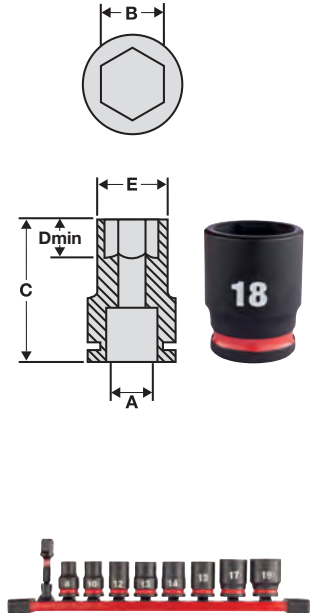

FASTENING

3/8" SHOCKWAVE™ IMPACT DUTY impact sockets - deep

A (mm)	B (mm)	C (mm)	D (mm)	E (mm)	For anchor thread size	Pack quantity	Min. order quantity	Article Number	EAN Code
3/8" square	6	65	3.1	10.5	M3.5	1	1	4932480280	4058546405656
3/8" square	7	65	3.6	12.6	M4	1	1	4932480281	4058546405663
3/8" square	8	65	3.6	13.9	M5	1	1	4932480282	4058546405670
3/8" square	9	65	4.1	14.5	-	1	1	4932480283	4058546405687
3/8" square	10	65	4.6	15.8	M6	1	1	4932480284	4058546405694
3/8" square	11	65	5.5	16.9	-	1	1	4932480285	4058546405700
3/8" square	12	65	6.1	18.8	M7	1	1	4932480286	4058546405717
3/8" square	13	65	6.8	19.5	M8	1	1	4932480287	4058546405724
3/8" square	14	65	8.4	20.5	-	1	1	4932480288	4058546405731
3/8" square	15	65	8.4	21.8	-	1	1	4932480289	4058546405748
3/8" square	16	65	9.6	23.8	M10	1	1	4932480290	4058546405755
3/8" square	17	65	9.6	24.8	-	1	1	4932480291	4058546405762
3/8" square	18	65	10.2	25.8	M12	1	1	4932480292	4058546405779
3/8" square	19	65	11	27.6	-	1	1	4932480293	4058546405786
3/8" square	20	65	11	27.8	-	1	1	4932480294	4058546405793
3/8" square	21	65	11.7	29.8	M14	1	1	4932480295	4058546405809
3/8" square	22	65	12.5	31.6	-	1	1	4932480296	4058546405816
3/8" SHOCKWAVE™ IMPACT DUTY socket deep rail set (9pc)						9	1	4932480455	4058546407407
8 x impact deep sockets: 8 / 10 / 12 / 13 / 16 / 17 / 18 / 19 mm and socket rail									
3/8" PACKOUT™ SHOCKWAVE™ IMPACT DUTY socket set (19pc)						19	1	4932480946	4058546412319
19 x 3/8" Impact sockets deep: 6 / 7 / 8 / 9 / 10 / 11 / 12 / 13 / 14 / 15 / 16 / 17 / 18 / 19 / 20 / 21 / 22 / 23 / 24 mm, 1 x 4932471065 PACKOUT™ slim organizer									

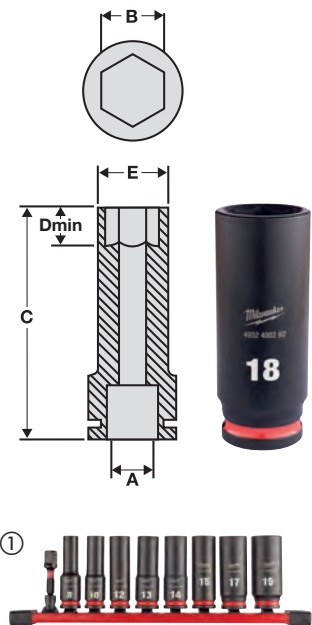



TM

3/8" impact sockets - extensions

Description	Total length (mm)	Pack quantity	Min. order quantity	Article Number	EAN Code
① 3/8" extension - 150 mm	150	1	1	4932480297	4058546405823
② 3/8" extension - 250 mm	250	1	1	4932480298	4058546405830

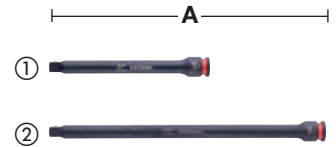

3/8" impact sockets - adaptors

Description	Total length (mm)	Pack quantity	Min. order quantity	Article Number	EAN Code
① Socket adaptor. 3/8" square - 1/4" square	28	1	1	4932480299	4058546405847
② Socket adaptor. 3/8" square - 1/2" square	37	1	1	4932480300	4058546405854



3/8" impact sockets - swivel joint

Description	Angle capacity	Pack quantity	Min. order quantity	Article Number	EAN Code
3/8" universal swivel joint	15°	1	1	4932480301	4058546405861



1/2" SHOCKWAVE™ IMPACT DUTY impact sockets - standard

A (mm)	B (mm)	C (mm)	D (mm)	E (mm)	For anchor thread size	Pack quantity	Min. order quantity	Article Number	EAN Code
1/2" square	8	38	4.2	15.0	M5	1	1	4932480302	4058546405878
1/2" square	9	38	4.5	16.3	-	1	1	4932480303	4058546405885
1/2" square	10	38	4.6	17.5	M6	1	1	4932480304	4058546405892
1/2" square	11	38	5.5	18.0	-	1	1	4932480305	4058546405908
1/2" square	12	38	6.1	19.0	M7	1	1	4932480306	4058546405915
1/2" square	13	38	6.8	20.0	M8	1	1	4932480307	4058546405922
1/2" square	14	38	8.4	22.0	-	1	1	4932480308	4058546405939
1/2" square	15	38	8.4	23.0	-	1	1	4932480309	4058546405946
1/2" square	16	38	9.6	24.0	M10	1	1	4932480310	4058546405953
1/2" square	17	38	9.6	26.2	-	1	1	4932480311	4058546405960
1/2" square	18	38	10.2	27.5	M12	1	1	4932480312	4058546405977
1/2" square	19	38	11.1	28.5	-	1	1	4932480313	4058546405984
1/2" square	20	38	11.5	29.2	-	1	1	4932480314	4058546405991
1/2" square	21	38	11.7	30.0	M14	1	1	4932480315	4058546406004
1/2" square	22	38	12.5	31.8	-	1	1	4932480316	4058546406011
1/2" square	23	40	12.7	33.8	-	1	1	4932480317	4058546406028
1/2" square	24	40	13.9	34.2	M16	1	1	4932480318	4058546406035
1/2" square	25	42	14.0	35.8	-	1	1	4932480319	4058546406042
1/2" square	26	42	14.6	37.0	-	1	1	4932480320	4058546406059
1/2" square	27	42	15.0	38.2	M18	1	1	4932480321	4058546406066
1/2" square	28	42	15.4	38.8	-	1	1	4932480322	4058546406073
1/2" square	29	42	16.7	42.0	-	1	1	4932480323	4058546406080
1/2" square	30	44	16.7	42.8	M20	1	1	4932480324	4058546406097
1/2" square	32	44	18.3	43.8	M22	1	1	4932480325	4058546406103

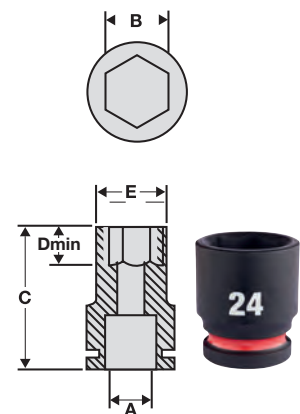

1/2" SHOCKWAVE™ IMPACT DUTY socket set STD (13pc)

10 x STD sockets: 10,12,13,14,15,17,19,21,22,24, 1 x universal joint 15°, 1 x adaptor 1/4" Hex - 1/2" square, 1 x extension 150 mm	13	1	4932480456	4058546407414
--	----	---	------------	---------------

SHOCKWAVE™ IMPACT DUTY



1/2" SHOCKWAVE™ IMPACT DUTY impact sockets - deep

A (mm)	B (mm)	C (mm)	D (mm)	E (mm)	For anchor thread size	Pack quantity	Min. order quantity	Article Number	EAN Code
1/2" square	8	78	4.2	15.0	M5	1	1	4932480326	4058546406110
1/2" square	9	78	4.2	16.3	-	1	1	4932480327	4058546406127
1/2" square	10	78	4.8	17.5	M6	1	1	4932480328	4058546406134
1/2" square	11	78	5.5	18.0	-	1	1	4932480329	4058546406141
1/2" square	12	78	6.1	19.0	M7	1	1	4932480330	4058546406158
1/2" square	13	78	6.8	20.0	M8	1	1	4932480331	4058546406165
1/2" square	14	78	8.4	22.0	-	1	1	4932480332	4058546406172
1/2" square	15	78	8.4	23.0	-	1	1	4932480333	4058546406189
1/2" square	16	78	9.8	24.0	M10	1	1	4932480334	4058546406196
1/2" square	17	78	9.8	26.2	-	1	1	4932480335	4058546406202
1/2" square	18	78	10.2	27.0	M12	1	1	4932480336	4058546406219
1/2" square	19	78	11.1	28.0	-	1	1	4932480337	4058546406226
1/2" square	20	78	11.5	29.3	-	1	1	4932480338	4058546406233
1/2" square	21	78	11.7	30.0	M14	1	1	4932480339	4058546406240
1/2" square	22	78	12.5	31.3	-	1	1	4932480340	4058546406257
1/2" square	23	78	12.7	33.8	-	1	1	4932480341	4058546406264
1/2" square	24	78	13.9	34.2	M16	1	1	4932480342	4058546406271
1/2" square	25	78	14.0	35.8	-	1	1	4932480343	4058546406288
1/2" square	26	78	14.8	37.0	-	1	1	4932480344	4058546406295
1/2" square	27	78	15.8	38.2	M18	1	1	4932480345	4058546406301
1/2" square	28	78	15.8	39.2	-	1	1	4932480346	4058546406318
1/2" square	29	78	15.8	42.0	-	1	1	4932480347	4058546406325
1/2" square	30	78	15.8	42.9	M20	1	1	4932480348	4058546406332
1/2" square	32	78	18.1	43.5	M22	1	1	4932480349	4058546406349
1/2" square	33	78	18.2	45.3	-	1	1	4932480350	4058546406356
1/2" square	36	78	20.0	50.0	M24	1	1	4932480351	4058546406363
1/2" SHOCKWAVE™ IMPACT DUTY deep socket set (10pc)									
①	10 x deep sockets: 10, 11, 12, 13, 14, 17, 19, 21, 22, 24 mm					10	1	4932480457	4058546407421
1/2" PACKOUT™ SHOCKWAVE™ IMPACT DUTY socket set (16pc)									
②	16 x 1/2" Impact sockets deep: 10 / 11 / 12 / 13 / 14 / 15 / 16 / 17 / 18 / 19 / 20 / 21 / 22 / 23 / 24 / 75 mm extension, 1 x 4932464083 PACKOUT™ compact organizer					16	1	4932480943	4058546412289

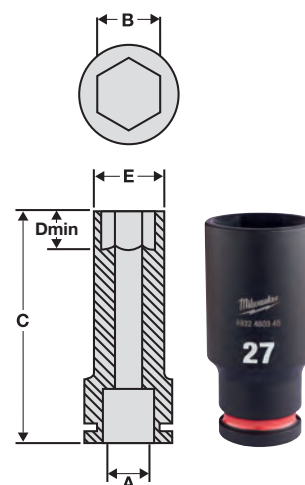

1/2" SHOCKWAVE™ IMPACT DUTY automotive impact socket set

Description	Pack quantity	Min. order quantity	Article Number	EAN Code
Automotive impact socket set (3pc) 17 mm, 19 mm and 21 mm 1/2" impact sockets	3	1	4932451568	4002395140091



1/2" impact sockets - extensions

Description	Total length (mm)	Pack quantity	Min. order quantity	Article Number	EAN Code
① 1/2" extension - 150 mm	150	1	1	4932480352	4058546406370
② 1/2" extension - 250 mm	250	1	1	4932480353	4058546406387

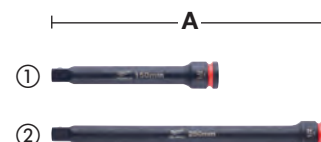

1/2" impact sockets - reducers

Description	Total length (mm)	Pack quantity	Min. order quantity	Article Number	EAN Code
① Socket adaptor. 1/2" square - 3/8" square	38	1	1	4932480354	4058546406394
② Socket adaptor. 1/2" square - 3/4" square	48	1	1	4932480355	4058546406400
③ Socket adaptor: 1/2" square - 1/4" Hex. To accept screwdriving bits	50	1	1	4932471828	4058546297275
④ 1/2" SHOCKWAVE™ IMPACT DUTY adaptor set (4pc)		4	1	4932480356	4058546406417



1/2" impact sockets - universal joint

Description	Angle capacity	Pack quantity	Min. order quantity	Article Number	EAN Code
1/2" SHOCKWAVE™ IMPACT DUTY universal joint	15°	1	1	4932480357	4058546406424



1/2" impact TX bit sockets

One-piece design TX bit and socket with 1/2" internal square drive reception according to DIN 3121 / ISO 1174-2. Suitable for higher torque fastening applications, fits directly onto 1/2" impact tools.

Description	Tool reception	Pack quantity	Min. order quantity	Article Number	EAN Code
TX30 1/2" impact bit socket	1/2" square	1	1	4932478059	4058546339920
TX40 1/2" impact bit socket	1/2" square	1	1	4932478060	4058546339937
TX45 1/2" impact bit socket	1/2" square	1	1	4932478061	4058546339944
TX50 1/2" impact bit socket	1/2" square	1	1	4932478062	4058546339951



1/2" impact HEX bit sockets

One-piece design HEX bit and socket with 1/2" internal square drive reception according to DIN 3121 / ISO 1174-2. Suitable for higher torque fastening applications, fits directly onto 1/2" impact tools.

Description	Tool reception	Pack quantity	Min. order quantity	Article Number	EAN Code
HEX5 1/2" impact bit socket	1/2" square	1	1	4932478063	4058546339968
HEX6 1/2" impact bit socket	1/2" square	1	1	4932478064	4058546339975
HEX8 1/2" impact bit socket	1/2" square	1	1	4932478065	4058546339982
HEX10 1/2" impact bit socket	1/2" square	1	1	4932478066	4058546339999
HEX12 1/2" impact bit socket	1/2" square	1	1	4932478067	4058546340001



SHOCKWAVE™ IMPACT DUTY



TM

3/4" SHOCKWAVE™ IMPACT DUTY impact sockets - standard

A (mm)	B (mm)	C (mm)	D (mm)	E (mm)	For anchor thread size	Pack quantity	Min. order quantity	Article Number	EAN Code
3/4" square	17	53	9.6	30	-	1	1	4932480361	4058546406462
3/4" square	19	53	11.1	33	-	1	1	4932480362	4058546406479
3/4" square	21	53	11.7	35	M14	1	1	4932480363	4058546406486
3/4" square	22	53	12.5	36	-	1	1	4932480364	4058546406493
3/4" square	23	53	12.7	37.6	-	1	1	4932480365	4058546406509
3/4" square	24	53	13.9	38	M16	1	1	4932480366	4058546406516
3/4" square	27	53	15.8	41	M18	1	1	4932480367	4058546406523
3/4" square	30	53	16.7	46	M20	1	1	4932480368	4058546406530
3/4" square	32	57	18.3	48	M22	1	1	4932480369	4058546406547
3/4" square	33	57	19.1	50	-	1	1	4932480370	4058546406554
3/4" square	34	57	20	51	-	1	1	4932480371	4058546406561
3/4" square	36	57	22.3	53.5	M24	1	1	4932480372	4058546406578
3/4" square	38	57	22.3	58	-	1	1	4932480373	4058546406585
3/4" square	39	57	21.5	58	-	1	1	4932480374	4058546406592
3/4" square	41	58	24.9	59.5	M27	1	1	4932480375	4058546406608
3/4" square	46	62	28.6	66.2	M30	1	1	4932480376	4058546406615
3/4" square	50	65	29.8	66.2	M33	1	1	4932480377	4058546406622

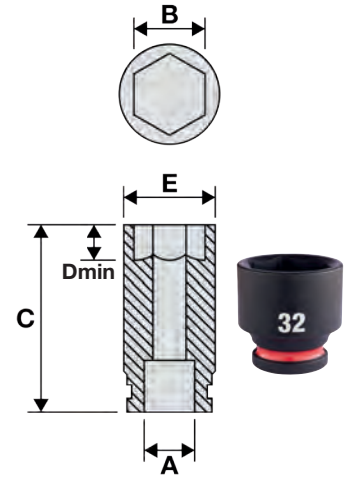

FASTENING

3/4" SHOCKWAVE™ IMPACT DUTY impact sockets - deep

A (mm)	B (mm)	C (mm)	D (mm)	E (mm)	For anchor thread size	Pack quantity	Min. order quantity	Article Number	EAN Code
3/4" square	17	90	9.6	30	-	1	1	4932480378	4058546406639
3/4" square	19	90	11.1	33	-	1	1	4932480379	4058546406646
3/4" square	21	90	11.7	35	M14	1	1	4932480380	4058546406653
3/4" square	22	90	12.5	36	-	1	1	4932480381	4058546406660
3/4" square	23	90	12.7	37.6	-	1	1	4932480382	4058546406677
3/4" square	24	90	13.9	38	M16	1	1	4932480383	4058546406684
3/4" square	25	90	14	40.5	-	1	1	4932480384	4058546406691
3/4" square	26	90	14.6	40.8	-	1	1	4932480385	4058546406707
3/4" square	27	90	15.8	41	M18	1	1	4932480386	4058546406714
3/4" square	28	90	16.3	45.2	-	1	1	4932480387	4058546406721
3/4" square	29	90	16.7	46	-	1	1	4932480388	4058546406738
3/4" square	30	90	16.7	46	M20	1	1	4932480389	4058546406745
3/4" square	31	90	17.8	47	-	1	1	4932480390	4058546406752
3/4" square	32	90	18.3	48	M22	1	1	4932480391	4058546406769
3/4" square	33	90	19.1	50	-	1	1	4932480392	4058546406776
3/4" square	34	90	20	51	-	1	1	4932480393	4058546406783
3/4" square	35	90	20.1	52	-	1	1	4932480394	4058546406790
3/4" square	36	90	22.3	53.5	M24	1	1	4932480395	4058546406806
3/4" square	37	90	20.4	54.8	-	1	1	4932480396	4058546406813
3/4" square	38	90	22.3	58	-	1	1	4932480397	4058546406820
3/4" square	39	90	21.5	58	-	1	1	4932480398	4058546406837
3/4" square	40	90	22.8	59.5	-	1	1	4932480399	4058546406844
3/4" square	41	90	24.9	59.5	M27	1	1	4932480400	4058546406851
3/4" square	46	90	28.6	66.2	M30	1	1	4932480401	4058546406868
3/4" square	50	90	29.8	72	M33	1	1	4932480402	4058546406875

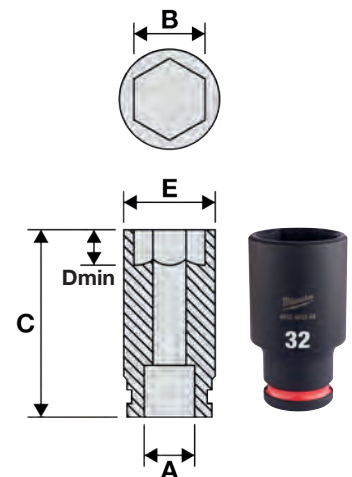

3/4" impact sockets - extensions

Description	Total length (mm)	Pack quantity	Min. order quantity	Article Number	EAN Code
① 3/4" extension - 175 mm	175	1	1	4932480403	4058546406882
② 3/4" extension - 250 mm	250	1	1	4932480404	4058546406899

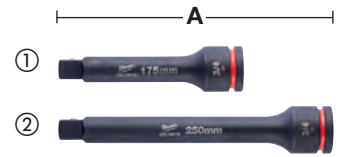

3/4" impact sockets - adaptors

Description	Total length (mm) A	Pack quantity	Min. order quantity	Article Number	EAN Code
① 3/4" to 1/2" SHOCKWAVE™ IMPACT DUTY adaptor	56.6	1	1	4932480405	4058546406905
② 3/4" to 1" SHOCKWAVE™ IMPACT DUTY adaptor	63	1	1	4932480406	4058546406912



3/4" SHOCKWAVE™ IMPACT DUTY universal joint

Description	Angle capacity	Pack quantity	Min. order quantity	Article Number	EAN Code
3/4" SHOCKWAVE™ IMPACT DUTY universal joint	25°	1	1	4932480407	4058546406929



3/4" impact sockets - security retaining ring

Description	Pack quantity	Min. order quantity	Article Number	EAN Code
3/4" impact sockets - security retaining ring	1	1	4932480450	4058546407353



SHOCKWAVE IMPACT DUTY TM

1" SHOCKWAVE™ IMPACT DUTY impact sockets - standard

A (mm)	B (mm)	C (mm)	D (mm)	E (mm)	For anchor thread size	Pack quantity	Min. order quantity	Article Number	EAN Code
1" square	27	58	15.8	45.2	M18	1	1	4932480408	4058546406936
1" square	30	62	16.7	49	M20	1	1	4932480409	4058546406943
1" square	32	62	18.3	52	M22	1	1	4932480410	4058546406950
1" square	33	62	19.1	54	-	1	1	4932480411	4058546406967
1" square	34	62	20	54	-	1	1	4932480412	4058546406974
1" square	36	65	22.3	55.3	M24	1	1	4932480413	4058546406981
1" square	38	65	22.3	58	-	1	1	4932480414	4058546406998
1" square	41	70	24.9	61	M27	1	1	4932480416	4058546407018
1" square	42	70	25.4	64	-	1	1	4932480417	4058546407025
1" square	46	75	28.6	68	M30	1	1	4932480418	4058546407032
1" square	50	75	29.8	73	M33	1	1	4932480419	4058546407049
1" square	55	83	33.6	82	M36	1	1	4932480420	4058546407056
1" square	60	87	35	86	M39	1	1	4932480421	4058546407063
1" square	65	90	35	92	M42	1	1	4932480422	4058546407070
1" square	70	93	35	97	M45	1	1	4932480423	4058546407087

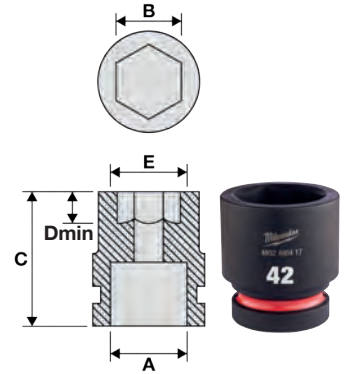

FASTENING

FORGED
HIGH TORQUE
IMPACT STEEL



46

STAMPED
AND INK FILLED



NON-SLIP
HEX GEOMETRY



COLOUR
BAND
INK FILLED





1" SHOCKWAVE™ IMPACT DUTY impact sockets - deep

A (mm)	B (mm)	C (mm)	D (mm)	E (mm)	For anchor thread size	Pack quantity	Min. order quantity	Article Number	EAN Code
1" square	27	92	15.8	45.2	M18	1	1	4932480424	4058546407094
1" square	30	92	16.7	49	M20	1	1	4932480425	4058546407100
1" square	32	92	18.3	52	M22	1	1	4932480426	4058546407117
1" square	33	92	19.1	54	-	1	1	4932480427	4058546407124
1" square	34	92	20	54	-	1	1	4932480428	4058546407131
1" square	36	92	22.3	55.3	M24	1	1	4932480429	4058546407148
1" square	38	92	22.3	58	-	1	1	4932480430	4058546407155
1" square	41	100	24.9	61	M27	1	1	4932480432	4058546407179
1" square	46	100	28.6	68	M30	1	1	4932480434	4058546407193
1" square	50	100	28.6	73	M33	1	1	4932480435	4058546407209
1" square	55	100	33.6	82	M36	1	1	4932480436	4058546407216
1" square	60	120	35	86	M39	1	1	4932480437	4058546407223
1" square	65	125	35	92	M42	1	1	4932480438	4058546407230

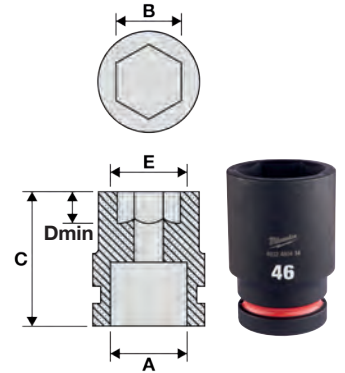

1" impact sockets - extensions

Description	Total length (mm)	Pack quantity	Min. order quantity	Article Number	EAN Code
① 1" extension - 175 mm	175	1	1	4932480440	4058546407254
② 1" extension - 250 mm	250	1	1	4932480441	4058546407261

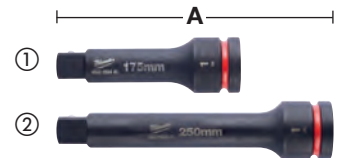

1" impact sockets - adaptor

Description	Total length (mm)	Pack quantity	Min. order quantity	Article Number	EAN Code
1" to 3/4" SHOCKWAVE™ IMPACT DUTY adaptor	70	1	1	4932480442	4058546407278



SHOCKWAVE™ IMPACT DUTY



TM

1" SHOCKWAVE™ IMPACT DUTY universal joint

Description	Angle capacity	Pack quantity	Min. order quantity	Article Number	EAN Code
1" SHOCKWAVE™ IMPACT DUTY universal joint	25°	1	1	4932480443	4058546407285



1" impact sockets - security retaining rings

Description	Pack quantity	Min. order quantity	Article Number	EAN Code
1" retaining ring for 27 - 44mm sockets	1	1	4932480451	4058546407360
1" retaining ring for 46 - 70mm sockets	1	1	4932480452	4058546407377



Impact sockets - rails & clips

Flexible interchangeable rails and clips for customisation of 1/4", 3/4", and 1/2" drive sockets. Compatible with standard and deep sockets, removable end caps for easy clip removal. Metal ball detent clip for superior socket retention. Usable with impact and chrome sockets. Holes in rail are on top and on the bottom for easy mounting.



Description	Length (mm)	Pack quantity	Min. order quantity	Article Number	EAN Code
1/4" impact socket rail	350	1	1	4932480444	4058546407292
1/4" extra rail clips - 10pcs	-	10	1	4932480445	4058546407308
3/8" impact socket rail	350	1	1	4932480446	4058546407315
3/8" extra rail clips - 10pcs	-	10	1	4932480447	4058546407322
1/2" impact socket rail	350	1	1	4932480448	4058546407339
1/2" extra rail clips - 10pcs	-	10	1	4932480449	4058546407346



1 SERVICE CLASS
INDOOR USE

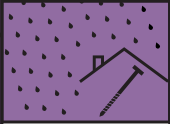

2 SERVICE CLASS
LIMITED
OUTDOOR USE



3 SERVICE CLASS
OUTDOOR USE



1 SERVICE CLASS
INDOOR USE



2 SERVICE CLASS
LIMITED
OUTDOOR USE



3 SERVICE CLASS
OUTDOOR USE

NAILS & STAPLES

Arm yourself for any carpentry and construction project with professional-grade nails & staples from MILWAUKEE®

Brad nails, 18 gauge, thin finish head

NEW

Suitable for M18 FN18GS
Collated straight strip

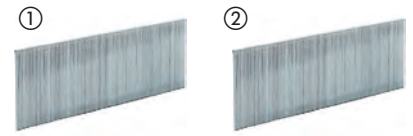

Wire gauge	Dimensions (mm)	Total length (mm)	Nail angle	Service class	Material	Pack quantity	Min. order quantity	Article Number	EAN Code
18	1.05 x 1.25	16	0°	1	Resin Coated. Galvanised	10.000	1	4932492549	4058546419165
18	1.05 x 1.25	19	0°	1	Resin Coated. Galvanised	10.000	1	4932492550	4058546419172
18	1.05 x 1.25	25	0°	1	Resin Coated. Galvanised	5.000	1	4932492551	4058546419189
① 18	1.05 x 1.25	30	0°	1	Resin Coated. Galvanised	5.000	1	4932492552	4058546419196
18	1.05 x 1.25	32	0°	1	Resin Coated. Galvanised	5.000	1	4932492553	4058546419202
18	1.05 x 1.25	40	0°	1	Resin Coated. Galvanised	5.000	1	4932492554	4058546419219
18	1.05 x 1.25	45	0°	1	Resin Coated. Galvanised	5.000	1	4932492555	4058546419226
18	1.05 x 1.25	50	0°	1	Resin Coated. Galvanised	5.000	1	4932492556	4058546419233
18	1.05 x 1.25	16	0°	3	Stainless / Rust free	10.000	1	4932492557	4058546419240
18	1.05 x 1.25	19	0°	3	Stainless / Rust free	10.000	1	4932492558	4058546419257
18	1.05 x 1.25	25	0°	3	Stainless / Rust free	5.000	1	4932492559	4058546419264
② 18	1.05 x 1.25	30	0°	3	Stainless / Rust free	5.000	1	4932492560	4058546419271
18	1.05 x 1.25	32	0°	3	Stainless / Rust free	5.000	1	4932492561	4058546419288
18	1.05 x 1.25	40	0°	3	Stainless / Rust free	5.000	1	4932492562	4058546419295
18	1.05 x 1.25	45	0°	3	Stainless / Rust free	5.000	1	4932492563	4058546419301
18	1.05 x 1.25	50	0°	3	Stainless / Rust free	5.000	1	4932492564	4058546419318

Finish nails, 15 gauge, D Head

NEW

Suitable for M18 CN15GA, M18 FN15GA
Collated angled strip



Wire gauge	Dimensions (mm)	Total length (mm)	Nail angle	Service class	Material	Pack quantity	Min. order quantity	Article Number	EAN Code
15	1.8	32	34°	1	Galvanised	4.000	1	4932492574	4058546419417
15	1.8	38	34°	1	Galvanised	2.500	1	4932492575	4058546419424
① 15	1.8	44	34°	1	Galvanised	2.500	1	4932492576	4058546419431
15	1.8	50	34°	1	Galvanised	2.500	1	4932492577	4058546419448
15	1.8	63	34°	1	Galvanised	2.200	1	4932492578	4058546419455
15	1.8	38	34°	3	Stainless / Rust free	2.500	1	4932492579	4058546419462
② 15	1.8	50	34°	3	Stainless / Rust free	2.500	1	4932492580	4058546419479
15	1.8	63	34°	3	Stainless / Rust free	2.200	1	4932492581	4058546419486

Finish nails, 16 gauge, thin finish head

NEW

Suitable for M18 CN16GA, M18 FN16GA
Collated angled strip



Wire gauge	Dimensions (Outer)(H x W x D / mm)	Total length (mm)	Nail angle	Service class	Material	Pack quantity	Min. order quantity	Article Number	EAN Code
16	1.35 x 1.61	32	20°	1	Galvanised	2,000	1	4932492582	4058546419493
16	1.35 x 1.61	38	20°	1	Galvanised	2,000	1	4932492583	4058546419509
16	1.35 x 1.61	45	20°	1	Galvanised	2,000	1	4932492584	4058546419516
16	1.35 x 1.61	50	20°	1	Galvanised	2,000	1	4932492585	4058546419523
16	1.35 x 1.61	64	20°	1	Galvanised	2,000	1	4932492586	4058546419530

Framing nails, 20°, round head

NEW

Suitable for M18 FFN21
Collated angled strip

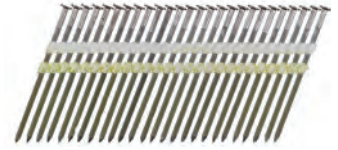

Shank diameter (mm)	Total length (mm)	Nail angle	Service class	Material	Pack quantity	Min. order quantity	Article Number	EAN Code
2.8	65	20°	1	Ring Shank, Bright	2.000	1	4932492587	4058546419547
2.8	75	20°	1	Ring Shank, Bright	2.000	1	4932492588	4058546419554
3.1	80	20°	1	Ring Shank, Bright	1.750	1	4932492589	4058546419561
3.1	90	20°	1	Ring Shank, Bright	1.750	1	4932492590	4058546419578
2.8	65	20°	2	Ring Shank, Galvanised	2.000	1	4932492591	4058546419585
3.1	75	20°	2	Ring Shank, Galvanised	1.750	1	4932492592	4058546419592
3.1	80	20°	2	Ring Shank, Galvanised	1.750	1	4932492593	4058546419608
3.1	90	20°	2	Ring Shank, Galvanised	1.750	1	4932492594	4058546419615

Framing nails, 34°, D head

NEW

Suitable for M18 FFN
Paper collated angled strip

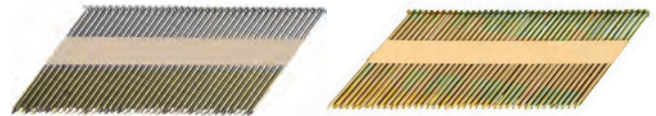

Shank diameter (mm)	Total length (mm)	Nail angle	Service class	Material	Pack quantity	Min. order quantity	Article Number	EAN Code
2.8	50	34°	1	Smooth Shank, Bright	2.200	1	4932492595	4058546419622
2.8	63	34°	1	Smooth Shank, Bright	2.200	1	4932492596	4058546419639
2.8	75	34°	1	Smooth Shank, Bright	2.200	1	4932492597	4058546419646
3.1	90	34°	1	Smooth Shank, Bright	2.200	1	4932492598	4058546419653
2.8	50	34°	1	Ring Shank, Bright	2.200	1	4932492599	4058546419660
2.8	63	34°	1	Ring Shank, Bright	2.200	1	4932492600	4058546419677
2.8	70	34°	1	Ring Shank, Bright	2.200	1	4932492601	4058546419684
2.8	75	34°	1	Ring Shank, Bright	2.200	1	4932492602	4058546419691
2.8	80	34°	1	Ring Shank, Bright	2.200	1	4932492603	4058546419707
3.1	90	34°	1	Ring Shank, Bright	2.200	1	4932492604	4058546419714
3.1	90	34°	2	Smooth shank, Galvanised	2.200	1	4932492605	4058546419721
2.8	50	34°	2	Ring Shank, Galvanised	2.200	1	4932492606	4058546419738
2.8	63	34°	2	Ring Shank, Galvanised	2.200	1	4932492607	4058546419745
2.8	75	34°	2	Ring Shank, Galvanised	2.200	1	4932492608	4058546419752
3.1	63	34°	2	Ring Shank, Galvanised	2.200	1	4932492609	4058546419769
3.1	75	34°	2	Ring Shank, Galvanised	2.200	1	4932492610	4058546419776
3.1	80	34°	2	Ring Shank, Galvanised	2.200	1	4932492611	4058546419783
3.1	90	34°	2	Ring Shank, Galvanised	2.200	1	4932492612	4058546419790
2.8	50	34°	3	Ring Shank, Hot Dipped Galvanised	2.200	1	4932492613	4058546419806
2.8	65	34°	3	Ring Shank, Hot Dipped Galvanised	2.200	1	4932492614	4058546419813
3.1	90	34°	3	Ring Shank, Hot Dipped Galvanised	2.200	1	4932492615	4058546419820

Staples

NEW

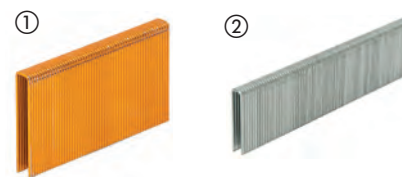

Type	Width (mm)	Dimensions (mm)	Total length (mm)	Service class	Material	Pack quantity	Min. order quantity	Article Number	EAN Code
① Fine wire staples for M12BST	10.6	0.5 x 1.25	6	1	Galvanised	1.400	1	4932492565	4058546419325
	10.6	0.5 x 1.25	6	1	Galvanised	5.000	1	4932492570	4058546419370
	10.6	0.5 x 1.25	8	1	Galvanised	1.000	1	4932492566	4058546419332
	10.6	0.5 x 1.25	8	1	Galvanised	5.000	1	4932492571	4058546419387
	10.6	0.5 x 1.25	10	1	Galvanised	900	1	4932492567	4058546419349
	10.6	0.5 x 1.25	10	1	Galvanised	5.000	1	4932492572	4058546419394
	10.6	0.5 x 1.25	12	1	Galvanised	750	1	4932492568	4058546419356
	10.6	0.5 x 1.25	14	1	Galvanised	600	1	4932492569	4058546419363
	10.6	0.5 x 1.25	14	1	Galvanised	5.000	1	4932492573	4058546419400
② Fine wire staples for M18 FNCS18GS	5.7	0.5 x 1.25	15	1	Resin Coated, Galvanised	7.200	1	4932492616	4058546419837
	5.7	0.5 x 1.25	20	1	Resin Coated, Galvanised	6.000	1	4932492617	4058546419844
	5.7	0.5 x 1.25	25	1	Resin Coated, Galvanised	4.400	1	4932492618	4058546419851
	5.7	0.5 x 1.25	30	1	Resin Coated, Galvanised	4.200	1	4932492619	4058546419868
	5.7	0.5 x 1.25	32	1	Resin Coated, Galvanised	3.600	1	4932492620	4058546419875
	5.7	0.5 x 1.25	35	1	Resin Coated, Galvanised	3.600	1	4932492621	4058546419882
	5.7	0.5 x 1.25	36	1	Resin Coated, Galvanised	3.600	1	4932492622	4058546419899
	5.7	0.5 x 1.25	38	1	Resin Coated, Galvanised	2.600	1	4932492623	4058546419905
	5.7	0.5 x 1.25	25	3	Stainless, Resin Coated	4.400	1	4932492624	4058546419912
	5.7	0.5 x 1.25	35	3	Stainless, Resin Coated	3.600	1	4932492625	4058546419929
	5.7	0.5 x 1.25	38	3	Stainless, Resin Coated	2.600	1	4932492626	4058546419936

Staples - fencing

NEW

Fencing staples for the MILWAUKEE® M18 FFUS.

For all types of wire fencing attached to wood ie. livestock fencing, square/chain/barbed wire and high tensile wire.

Hot dipped galvanised coating for superior long term corrosion resistance.

4mm thick steel wire for best lifetime in outdoor applications.

Sharp divergent point tips – the staple point tip twists as it is driven into the wood giving better holding power.

Red adhesive coating for increased drivability while maximizing holding power.

Paper tape collation for speed and convenience.



Total length (mm)	Width (mm)	Service class	Pack quantity	Min. order quantity	Article Number	EAN Code
40	20	3	960	1	4932480358	4058546406431
45	20	3	960	1	4932480359	4058546406448
50	20	3	960	1	4932480360	4058546406455

Staples - electrical cable

NEW

Cable staples for the MILWAUKEE® M12 BCST

19mm wide 25mm long staples for fixing all types of electrical/ data cable to wooden joists / structures. Not suitable for fixing to concrete.

Flat top staple with a plastic bridge on the inside. The plastic bridge ensures cables will not be damaged or cut when fixed.

Suitable only for internal use.

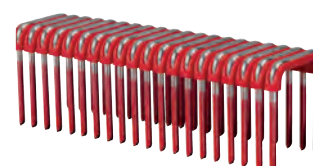

Total length (mm)	Width (mm)	Pack quantity	Min. order quantity	Article Number	EAN Code
25	19	600	1	4932479628	4058546374228



SAWZALL™

BLADE SELECTION GUIDE

1. Identify the material to be cut in the rows below.
2. Follow the row across to find best/compatible performance.

BEST PERFORMANCE

GOOD PERFORMANCE



DEMOLITION BLADES

AX™ CARBIDE



AX™



THIN KERF



METAL CUTTING BLADES

TORCH™ NITRUS CARBIDE



TORCH™ CARBIDE



TORCH™



THIN KERF



UNIVERSAL BLADES

WRECKER™ CARBIDE



WRECKER™



Art. Nr. 48005092



Art. Nr. 48005293



Art. Nr. 48005093



WOOD CUTTING BLADES

Art. Nr. 48001075



Art. Nr. 48001077











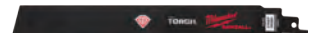



Art. Nr. 48001079



SPECIAL APPLICATION BLADES

DIAMOND GRIT



TPI	BLADE THICKNESS (MM)	 THICK METAL > 4MM	 MEDIUM METAL 1.5 - 4MM	 THIN METAL 0.5 - 3MM	 STAINLESS STEEL	 CAST IRON	 NON FERROUS METALS (CU/AL)	 WOOD	 GREEN WOOD	 WOOD WITH NAILS & SCREWS	 PALLETS	 PVC Pipe
5	1.27							Black		Black		
5	1.60							Black		Black		
5	1.27							Red		Red		
8	1.27	Black	Black/Red		Black/Red	Black	Black					
8	1.27	Black	Black/Red		Black/Red	Red	Black					
10	1.10	Faster/Rougher	Faster/Rougher				Black					
14	1.10	↕	↕	Black	Red		Black					
18	1.10	Slower/Smother	Slower/Smother	Black	Red		Black					
14	0.90	Faster/Rougher	Faster/Rougher		Red		Black					Black
18	0.90	↕	↕	Black	Red		Black					Black
25	0.90	Slower/Smother	Slower/Smother	Black	Red		Black					Black
6	1.27	Black	Black/Red			Red	Black				Black	
7/11	1.60	Black	Black				Black				Black	
10	0.90	Red	Black				Black					
10/14	0.90	Red	Black				Black			Red	Black	Black
8/12	1.27	Red	Black				Black			Red	Black	Black
4.2	1.27							Black	Red			
5.5/6	1.27							Black	Black			
8.5	1.27							Black				
GRIT	1.10					Black						



Nothing but **HEAVY DUTY.**[™]

INTRODUCING

NITRUS CARBIDE[™]

TORCH[™]
NITRUS CARBIDE

**CUT
TOUGHER**

Our SAWZALL[™] The TORCH[™] with NITRUS CARBIDE[™] for CAST IRON and other thick metals is the next generation of carbide teeth technology. The blade delivers 3X the life of existing carbide teeth reciprocating saw blades to continuously make the toughest cast iron removals on the job.

*vs standard Carbide blades

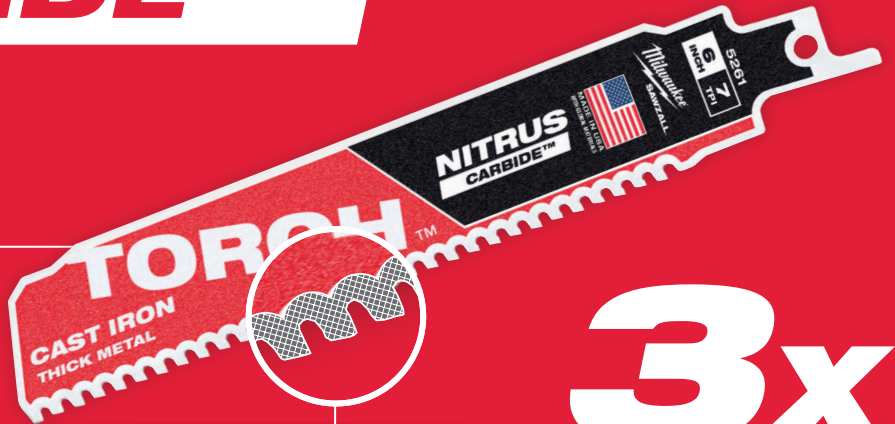

3x
LONGER LIFE*

CARBIDE TEETH

CUT LONGER. CUT MORE. CUT FASTER.



THE
TORCH[™]
CARBIDE TEETH



AX[™]
CARBIDE TEETH



THE
WRECKER[™]
CARBIDE TEETH

x50
LONGER LIFE

This blade delivers up to 50X life over bi-metal standard blades

1000
MORE CUTS

The Ax with Carbide Teeth is optimized for Cordless Recip Saws delivering over 25% more cuts per charge

x2
FASTER CUTS

This blade delivers up to 2X faster cuts than bi-metal standard blades

Metal: Heavy duty TORCH™ with NITRUS CARBIDE™

The TORCH™ blades with NITRUS CARBIDE™ teeth is the next generation of carbide technology. This special carbide NITRUS blend is designed to cut 3x longer than existing standard carbide teeth blades. Constructed with a 8 Tpi design for fast starts and smooth cuts, large gullets for easy chip ejection, and a unique carbide blend, the TORCH™ Blades with NITRUS CARBIDE™ are designed to last the longest and cut the fastest in cast iron / SML pipe and other thick metals.

Thick 1.27 mm robust blade body for precise straight cuts.
25 mm blade height for improved stability and minimum vibration.
Best performance in all thick metals and especially cast iron soil, waste and drainage pipes



Scan the QR Code to see our full video.

Blade length (mm)	Tooth pitch (mm)	Teeth per inch	Ref. No.							Pack quantity	Min. order quantity	Article Number	EAN Code
150	3.2	8	-	5 - 13	Ø 10 - 100	5 - 13	Ø 10 - 100	5 - 13	Yes	1	1	48005261	045242569694
										5	1	48005561	045242569717
230	3.2	8	-	5 - 13	Ø 10 - 175	5 - 13	Ø 10 - 175	5 - 13	Yes	1	1	48005262	045242569724
										5	1	48005562	045242569748
300	3.2	8	-	5 - 13	Ø 10 - 250	5 - 13	Ø 10 - 250	5 - 13	Yes	1	1	48005263	045242569755
										5	1	48005563	045242569779

Metal: Heavy duty TORCH™ carbide teeth

Carbide teeth provide for longest life in thick metals - up to 50x more life compared to Bi-Metal blades
Thick 1.27 mm robust blade body for precise straight cuts
25 mm blade height for improved stability and minimum vibration
Best for cast iron and all thick metal demolition

THE
TORCH™
CARBIDE TEETH

Blade length (mm)	Tooth pitch (mm)	Teeth per inch	Ref. No.							Pack quantity	Min. order quantity	Article Number	EAN Code
150	3.2	8	-	5 - 13	Ø 10 - 175	5 - 13	Ø 10 - 100	5 - 13	Yes	1	1	48005201	045242521036
										5	1	48005501	045242520862
230	3.2	8	-	5 - 13	Ø 10 - 175	5 - 13	Ø 10 - 175	5 - 13	Yes	1	1	48005202	045242520787
										5	1	48005502	045242520879
300	3.2	8	-	5 - 13	Ø 10 - 175	5 - 13	Ø 10 - 250	5 - 13	Yes	1	1	48005203	045242520794
										5	1	48005503	045242520886

Metal: Heavy duty TORCH™ demolition blades

THE **TORCH**™

STIFFEST



LONGEST



STRONGEST

DOUBLE DUTY UPGRADE™



Improved tooth geometry for best speed and double the lifetime. Thick 1.06 mm robust blade body for precise cuts. 25 mm blade height for improved stability and minimum vibration. Bi-Metal quality cutting teeth with 8% cobalt the ultimate in performance and lifetime.







Stamped indentations around the reception strengthens the blade at its weakest point.



A grid iron pattern is built into the blade to make it more rigid with less tendency to bend or buckle for best durability and straight cuts.



Metal: Heavy duty TORCH™ demolition blades

Blade length (mm)	Tooth pitch (mm)	Teeth per inch	Ref. No.						Pack quantity	Min. order quantity	Article Number	EAN Code		
150	1.4	18	-	2 - 8	Ø 10 - 100	2 - 8	2 - 4	Yes	5	1	48005784	045242083084		
									25	1	48008784	045242082407		
230	1.4	18	-	2 - 8	Ø 10 - 160	2 - 8	2 - 4	Yes	5	1	48005788	045242083091		
									25	1	48008788	045242082421		
300	1.4	18	-	2 - 8	Ø 10 - 180	2 - 8	2 - 4	Yes	5	1	48005789	045242083107		
									25	1	48008789	045242082438		
150	1.8	14	-	3 - 10	Ø 10 - 100	3 - 10	3 - 7	Yes	5	1	48005782	045242083060		
									25	1	48008782	045242082391		
230	1.8	14	-	3 - 10	Ø 10 - 160	3 - 10	3 - 7	Yes	5	1	48005787	045242083077		
									25	1	48008787	045242082414		
150	2.5	10	-	4 - 10	Ø 10 - 100	4 - 10	4 - 10	Yes	5	1	48005712	045242083039		
									25	1	48008712	045242082377		
230	2.5	10	-	4 - 10	Ø 10 - 160	4 - 10	4 - 10	Yes	5	1	48005713	045242083046		
									25	1	48008713	045242082384		
300	2.5	10	-	4 - 10	Ø 10 - 180	4 - 10	4 - 10	Yes	5	1	48005714	045242222810		

Metal: THIN KERF blades



DOUBLE DUTY UPGRADE



Improved tooth geometry for best speed and double the lifetime. Bi-Metal quality cutting teeth with 8% Cobalt the ultimate in performance and lifetime.



















Stamped indentations around the reception strengthens the blade at its weakest point.

THIN KERF

Slim 0.90 mm thick blade body optimised for maximum speed and flexibility.

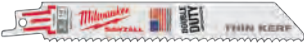

Metal: THIN KERF blades

Blade length (mm)	Tooth pitch (mm)	Teeth per inch	Ref. No.								Pack quantity	Min. order quantity	Article Number	EAN Code	
	100	1	24	S522AF	0.5 - 3	0.5 - 3	Ø 8 - 50	0.5 - 3	0.5 - 3	No	No	5	1	48005185	045242082865
	150	1	24	S922AF	0.5 - 3	0.5 - 3	Ø 8 - 100	0.5 - 3	0.5 - 3	No	No	5	1	48005186	045242082872
	100	1.4	18	S522EF	1.5 - 4	1.5 - 4	Ø 10 - 50	1.5 - 4	1.5 - 4	No	No	5	1	48005183	045242082841
	150	1.4	18	S922EF	1.5 - 4	1.5 - 4	Ø 10 - 100	1.5 - 4	1.5 - 4	No	No	5	1	48005184	045242082858
												50	1	48016184	045242084739
	230	1.4	18	S1122EF	1.5 - 4	1.5 - 4	Ø 10 - 100	1.5 - 4	1.5 - 4	No	No	5	1	48005188	045242082896
												50	1	48016188	045242084876
	300	1.4	18	-	1.5 - 4	1.5 - 4	Ø 10 - 180	1.5 - 4	1.5 - 4	No	Yes	5	1	48005189	045242082902
												50	1	48016189	045242084883
	90	1.8	14	S422BF	1.5 - 6	1.5 - 6	-	1.5 - 4	-	Yes	No	5	1	48005162	045242082803
	100	1.8	14	S522BF	3 - 10	-	Ø 10 - 50	3 - 10	2 - 4	No	No	5	1	48005181	045242082827
	150	1.8	14	S922BF	3 - 10	-	Ø 10 - 100	3 - 10	2 - 4	No	No	5	1	48005182	045242082834
												50	1	48016182	045242084722
	230	1.8	14	S1122BF	3 - 10	-	Ø 10 - 160	3 - 10	2 - 4	No	No	5	1	48005187	045242082889
												50	1	48016187	045242084869



Wood with nails: Heavy duty AX™ carbide teeth demolition blades



Up to 50x longer life than standard Bi-Metal blades. Carbide teeth deliver long life and extreme durability in the toughest applications. Cuts through hardened screws and fasteners.

Up to 2x faster than standard Bi-Metal blades. A fast and aggressive 5 Tpi tooth pattern allows for the fastest cutting in nail embedded wood and a wide range of construction materials (wood/nails/bolts/screws/cast iron/asphalt roofing felt shingles).

Up to 25% more cuts per charge vs. standard Bi-Metal blades. Optimised for use with cordless reciprocating saws.

FANG TIP™: For faster plunge cutting and reaching into restricted areas.

NAIL GUARD™: Protects the tooth during nail impacts for increased durability and lifetime.

Sloped shape: Excellent for plunge cutting and reaching into restricted areas.

Thick 1.27 mm robust blade body for precise straight cuts.

25 mm blade height for improved stability and minimum vibration.

Best for wood / nails / hardened fasteners demolition

Blade length (mm)	Tooth pitch (mm)	Teeth per inch	Ref. No.								Pack quantity	Min. order quantity	Article Number	EAN Code
150	5	5	-	10 - 100	10 - 100	Ø 10 - 100	Yes	Yes	Yes		1	1	48005221	045242483716
											5	1	48005521	045242521104
230	5	5	-	10 - 175	10 - 175	Ø 10 - 175	Yes	Yes	Yes		1	1	48005226	045242483723
											5	1	48005526	045242521111
300	5	5	-	10 - 250	10 - 250	Ø 10 - 250	Yes	Yes	Yes		1	1	48005227	045242483730
											5	1	48005527	045242521128

Wood with nails: Heavy duty AX™ demolition blades

THE AX™

FANG TIP™: For faster plunge cutting and reaching into restricted areas.

NAIL GUARD™: Protects the tooth during nail impacts for increased durability and lifetime.

Strong: Thick 1.27mm body for maximum robustness and life making it ideal for wood with nails or bolts.

Fast: Aggressive 5 Tpi tooth geometry removes more material per stroke for faster cutting.

Sloped shape: Excellent for plunge cutting and reaching into restricted areas.

Shatter resistant: Bi-Metal construction allows the blade to bend and flex without breaking.



Blade length (mm)	Tooth pitch (mm)	Teeth per inch	Ref. No.							Pack quantity	Min. order quantity	Article Number	EAN Code
	5	5	-	10 - 100	10 - 100	10 - 50	Yes	Yes	Yes	5	1	48005021	045242082988
										25	1	48008021	045242082285
	5	5	-	10 - 175	10 - 175	10 - 50	Yes	Yes	Yes	5	1	48005026	045242082995
										25	1	48008026	045242082292
	5	5	-	10 - 250	10 - 250	10 - 50	Yes	Yes	Yes	5	1	48005027	045242083022
										25	1	48008027	045242082308

Wood with nails: THIN KERF demolition blades

FANG TIP™: For faster plunge cutting and reaching into restricted areas.

NAIL GUARD™: Protects the tooth during nail impacts for increased durability and lifetime.

Strong: 1.27 mm thick blade body for good strength and blade life making it ideal for wood with nails or bolts.

Fast: Aggressive 5 Tpi geometry removes more material per stroke for faster cutting.

Sloped shape: Excellent for plunge cutting and reaching into restricted areas.

Shatter resistant: Bi-Metal construction allows the blade to bend and flex without breaking.



Blade length (mm)	Tooth pitch (mm)	Teeth per inch	Ref. No.						Pack quantity	Min. order quantity	Article Number	EAN Code
	5	5	S611DF	10 - 100	10 - 100	Ø 10 - 100	Yes	Yes	5	1	48005035	045242082698
									50	1	48016035	045242084791
	5	5	S1111DF	10 - 175	10 - 175	Ø 10 - 175	Yes	Yes	5	1	48005036	045242082704
									50	1	48016036	045242084661
	5	5	S1411DF	10 - 250	10 - 250	Ø 10 - 250	Yes	Yes	5	1	48005037	045242082711
									50	1	48016037	045242084807



Multi material : Heavy duty WRECKER[™] carbide teeth demolition blades

The multi material WRECKER[™] with carbide teeth cuts all from thick metal, cast iron, nail embedded wood, hardened screws and fasteners.

Up to 50x longer life than standard Bi-metal blades. Carbide teeth deliver long life and extreme durability in the toughest applications.

Up to 25% more cuts per charge vs. standard Bi-Metal blades. Optimised for use with cordless tools.

FANG TIP[™]: For faster plunge cutting and reaching into restricted areas.

Thick 1.27mm robust blade body for precise straight cuts.

25 mm blade height for improved stability and minimum vibration.

Best for multi material demolition (wood with nails or hardened fasteners, cast iron and thick metal)



Blade length (mm)	Tooth pitch (mm)	Teeth per inch	Ref. No.								Pack quantity	Min. order quantity	Article Number	EAN Code
150	4.2	6	-	5-13	Ø 10 - 100	5-13	Ø 10 - 100	Yes	Yes	Yes	1	1	48005241	045242567980
											5	1	48005541	045242568048
230	4.2	6	-	5-13	Ø 10 - 175	5-13	Ø 10 - 175	Yes	Yes	Yes	1	1	48005242	045242567997
											5	1	48005542	045242568055
300	4.2	6	-	5-13	Ø 10 - 250	5-13	Ø 10 - 250	Yes	Yes	Yes	1	1	48005243	045242568000
											5	1	48005543	045242568062

Multi material: Heavy duty WRECKER™ blades











THE WRECKER™

Strong and precise: Thick 1.27 mm blade body.









Bi-Metal construction: Excellent blade life and performance.

Tooth geometry: Aggressive strengthened tooth tip design and uniform gullet depth allows for more material to be removed per stroke for faster cutting.

Blade shape: Sloped - The sloped shape makes this blade ideal for plunge cutting. Most suited for cutting metal and for demolition applications (wood with nails).

Blade length (mm)	Tooth pitch (mm)	Teeth per inch	Ref. No.								Pack quantity	Min. order quantity	Article Number	EAN Code
	150	3.6/2.3	7/11	-	4 - 10	Ø 10 - 100	4 - 10	4 - 10	Yes	Yes	5	1	48005701	045242082476
	230	3.6/2.3	7/11	-	4 - 10	Ø 10 - 160	4 - 10	4 - 10	Yes	Yes	5 25	1 1	48005706 48008706	045242082483 045242082520
	300	3.6/2.3	7/11	-	4 - 10	Ø 10 - 180	4 - 10	4 - 10	Yes	Yes	5 25	1 1	48005711 48008711	045242082490 045242082537

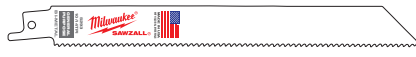
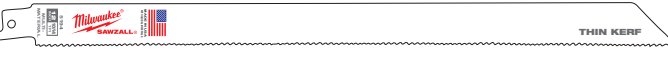
Multi material: wood / metal / plastic cutting blades

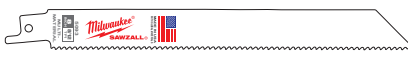
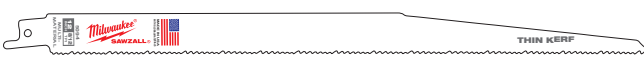
Blade length (mm)	Tooth pitch (mm)	Teeth per inch	Ref. No.						Pack quantity	Min. order quantity	Article Number	EAN Code	
	150	2.5	10	-	3 - 10	3 - 10	5 - 50	Yes	Ø 3 - 50	5	1	48005092	045242082766
	150	2.5/1.8	10/14	SS922VF	3 - 10	3 - 10	5 - 100	Yes	Ø 3 - 100	5 50	1 1	48005292 48016292	045242350490 045242084081
	200	2.5/1.8	10/14	-	3 - 10	3 - 10	5 - 175	Yes	Ø 3 - 160	5 50	1 1	48005293 48016293	045242265657 045242084098
	300	2.5/1.8	10/14	-	3 - 10	3 - 10	5 - 250	Yes	Ø 3 - 250	5	1	48005194	045242082926
	150	3.2/2.1	8/12	-	3 - 10	3 - 10	5 - 100	Yes	Ø 3 - 100	5 50	1 1	48005091 48016091	045242082759 045242084685
	200	3.2/2.1	8/12	-	3 - 10	3 - 10	5 - 175	Yes	Ø 3 - 160	5 50 500	1 1 1	48005093 48016093 48016000	045242082773 045242084708 045242084951
	300	3.2/2.1	8/12	-	3 - 10	3 - 10	5 - 250	Yes	Ø 3 - 250	5 50	1 1	48005094 48016094	045242082780 045242084715

Wood and plastics

Blade length (mm)	Tooth pitch (mm)	Teeth per inch	Ref. No.						Pack quantity	Min. order quantity	Article Number	EAN Code			
	150	4.2	6	S644D	6 - 100	-	6 - 100	No	Yes	3	1	48001075	045242079810		
	150	4.2	6	S744D	6-50	-	6-50	Yes	No	3	1	48001076	045242079827		
	230	4.2	6	-	6 - 190	6 - 190	6 - 100	No	Yes	5	1	48005016	045242082636		
	240	5.5/6	4/5	S1531L	15 - 190	15 - 190	-	No	No	3	1	48001077	045242079834		
	240	5.5/6	4/5	4932478111	15 - 190	15 - 190	-	No	No	50	1	4932478111	4058546340445		
	240	8.5	3	S1542K	15 - 190	-	-	No	No	3	1	48001078	045242079841		
	275	4.2	6	-	6 - 200	6 - 200	-	No	No	2	1	4932471693	4058546295929		
	300	4.2	6	S1344D	6 - 250	-	-	No	No	3	1	48001079	045242079858		

SAWZALL[™] blades for special materials

Special application: Ductwork blade

Plunge tip - fast plunging in materials < 0.6 mm. No need for extra tools.
 Versatility - tapered blade body profile allows for tight radius cutting and square cuts.
 Longlife - optimized tooth geometry 30 tpi for cutting thin material 0.6 - 1.5 mm. Most common spiral duct is 0.8 mm thick.



Blade length (mm)	Tooth pitch (mm)	Teeth per inch	Pack quantity	Min. order quantity	Article Number	EAN Code		
85	0.8	30	5	1	48001630	045242300174		











Special application: Drywall / plasterboard blade







Precise depth of cut - only 63 mm long, protects from unintentional cuts in pipes or wiring.
 Double sided teeth - cuts in ALL directions - produces less dust than jobsaw handtool - cuts clean without ripping the drywall.
 Plunge tip - fast and effortless plunging.

Blade length (mm)	Tooth pitch (mm)	Teeth per inch			Pack quantity	Min. order quantity	Article Number	EAN Code			
63	-	-	Yes	Yes	1	1	48001640	045242300181			
	125	4.2	6	Yes	Yes	5	1	48005052	045242082735		



Special application: Cast iron / abrasive materials / fibreglass

Blade length (mm)	Tooth pitch (mm)	Teeth per inch	Ref. No.						Pack quantity	Min. order quantity	Article Number	EAN Code	
	230	Diamond grit	-	Ø 10 - 160	Ø 10 - 160	3 - 175	-	-	1	1	48001450	045242187416	
	150	Carbide grit	-	Ø 10 - 100	Ø 10 - 100	3 - 100	-	-	3	1	48001420	045242081950	
	230	Carbide grit	S1130R	Ø 10 - 160	Ø 10 - 160	3 - 175	-	-	3	1	48001430	045242082001	
	305	8.5	3	S1241HM	-	-	6 - 150	10 - 250	1	1	48001080	045242079865	
	450	17.0	1.5	-	-	-	6 - 150	10 - 350	10 - 350	1	1	48001460	045242235353

Special application: Insulation material / carton / foam

Blade length (mm)	Tooth pitch (mm)	Teeth per inch	Ref. No.					Pack quantity	Min. order quantity	Article Number	EAN Code	
	300	Wave knife	Wave knife	-	Yes	Yes	Yes	Yes	1	1	48001084	045242079902

Special application: Frozen materials

	300	4.2	6	S1211K					1	1	48001082	045242079889
	400	4.2	6	-					1	1	48001083	045242079896

Special Application: Flush cut blade



Flush cuts against floor - floor guard protects teeth from floor contact when cutting flush to the floor.
 Extra tall blade body - guides blade for straighter cuts ie. when cutting out doors and windows in wood construction.
 FANG TIP™ - for easy and quick plunging.
 Suitable for cutting all types of wood and nail embedded wood. Not suitable for brick, masonry or steel.

Blade length (mm)	Tooth pitch (mm)	Teeth per inch	Ref. No.	Pack quantity	Min. order quantity	Article Number	EAN Code
300	5	5	-	1	1	48001600	045242253272

SAWZALL™ blade sets

Description	Pack quantity	Min. order quantity	Article Number	EAN Code	
SAWZALL™ blade set (5pc)					①
① 1 x AX™ wood with nails - 230 mm, 1 x WRECKER™ multi material - 230 mm, 1 x TORCH™ metal - 230 mm, 1 x TORCH™ metal - 150 mm, 1 x TORCH™ metal - 150 mm	5	1	49222205	045242536528	
SAWZALL™ carbide demolition blades set (5pc)					②
② Wood with nails: 2 x AX™ carbide - 230 mm / 5TPI. Metal: 2 x TORCH™ carbide - 150 mm / 8 TPI, 1 x TORCH™ carbide - 230 mm / 8 TPI	5	1	49222206	045242567492	
SAWZALL™ blade set (10pc)					③
③ 3 x THIN KERF metal - 150 mm, 3 x THIN KERF metal - 150 mm, 2 x THIN KERF wood with nails - 150 mm, 1 x THIN KERF wood with nails - 230 mm, 1 x THIN KERF metal - 230 mm	10	1	49222211	045242536856	
SAWZALL™ blade set (12pc)					④
④ 2 x AX™ wood with nails - 150 mm, 2 x AX™ wood with nails - 230 mm, 4 x TORCH™ metal - 150 mm, 2 x TORCH™ metal - 230 mm, 2 x WRECKER™ multi material - 150 mm	12	1	49222229	045242536863	
SAWZALL™ blade set (13pc)					⑤
⑤ 2 x WRECKER™ multi material - 150 mm, 2 x AX™ wood with nails - 150 mm, 2 x AX™ wood with nails - 230 mm, 4 x TORCH™ metal - 150 mm, 2 x TORCH™ metal - 230 mm, 1 x TORCH™ carbide - 150 mm	13	1	49222231	045242540686	

System accessories - SAWZALL™

Description	Fits MILWAUKEE® SAWZALL™	Pack quantity	Min. order quantity	Article Number	EAN Code
Conversion kit: to convert FIXTEC blade reception models to keyed blade reception to accept 20 mm reception blades	SSE 1000 QX, SSPE 1000 QX, SSH 800 QX Hatchet, PSH 18v hatchet, V18 SX, SSPE 1300 QX, M18 FUEL™ SAWZALL, USE 980 X, V28 SX, SSPE 1500 X	1	1	42680685	
Clamp		1	1	06832976	
Screw		1	1	49960070	045242221554
Allen key 5/32"		1	1	49960070	045242221554
Conversion kit: to convert FIXTEC blade reception models to keyed blade reception to accept 1/2" universal reception blades	SSE 1000 QX, SSPE 1000 QX, SSH 800 QX Hatchet, PSH 18v hatchet, V18 SX, SSPE 1300 QX, M18 FUEL™ SAWZALL, USE 980 X, V28 SX, SSPE 1500 X	1	1	49225016	045242182060
Clamp		1	1	06832976	
Screw		1	1	49960070	045242221554
Allen key 5/32"		1	1	49960070	045242221554
Transport case for sabre saws / SAWZALL™	V18 SX, V28 SX	1	1	201602001	4002395836383
Cases supplied with latches and foam insert. Size 1 (L x W x H) 475 x 358 x 132 mm	PSH 18v hatchet	1	1	4932453385	4002395146376















HACKZALL™ blades

Especially engineered blades for exclusive use on 12 V HACKZALL™.

Bi-Metal construction for increased tooth durability.

Optimised tooth form for aggressive and faster cutting.

Thinner blade body for better speed of cut and up to 35% more cuts per charge vs. standard Bi Metal blades.

Blade length (mm)	Tooth pitch (mm)	Teeth per inch							Pack quantity	Min. order quantity	Article Number	EAN Code		
	4.2	6	-	-	-	-	6 - 40	Ø 10 - 40	5	1	49005460	045242160273		
	1.8	14	3 - 6	Ø 10 - 32	3 - 6	3 - 6	-	Ø 10 - 50	5	1	49005614	045242160334		
	1.4	18	1.5 - 4	Ø 10 - 32	1.5 - 4	-	-	-	5	1	49005418	045242160341		
	1	25	0.5 - 3	Ø 8 - 32	0.5 - 3	-	-	-	5	1	49005424	045242160358		
	-	-	75 mm scraper: for removing strong adhesive silicon, caulk, paint and rust.											
75	-	-	-	-	-	-	-	-	1	1	49005456	045242219476		
	-	-	125 mm wide scraper: for removing glue, silicon, caulk, vinyl, rust, paint and wallpaper.											
125	-	-	-	-	-	-	-	-	1	1	49005455	045242293421		
	-	-	Grout removal blade: for removing damaged or moulded grout between tiles.											
60	-	-	-	-	-	-	-	-	1	1	49005450	045242221066		
									10	1	49220220	045242160365		
HACKZALL™ blade set (10 pc)														
2 x 49005460, 3 x 49005614, 3 x 49005424, 2 x 49005418														



JIGSAW BLADES

MATERIAL QUALITIES

HCS

- High Carbon Steel jigsaw blades are used for cutting all types of wood and plastics.

HSS

- High Speed Steel blades are suited to cutting metal, non ferrous metal and aluminium.

CARBIDE GRIT

- These blades have a tungsten carbide grit edge making them suitable for abrasive materials.

TC

- Blades with tungsten carbide tipped teeth are ideally suited to glassfibre reinforced products. Those blades with a continuous tungsten carbide tooth strip cutting edge are suitable for extremely hard materials such as stainless steel.

BI-METAL

- Bi-Metal blades consist of high speed steel teeth electron beam welded onto a flexible alloy steel back. These blades offer maximum performance in the most demanding applications in both wood and metal.

BI-METAL BLADES OFFER THE FOLLOWING BENEFITS:

- Flexible and shatter resistant
- Longer lifetime. Metal cutting blades offer double the lifetime and wood cutting blades more than 5 times the lifetime over conventional HCS and HSS blades.
- High wear rate and heat resistance ensure the teeth stay sharp longer.
- Faster cutting performance.

Flexible and shatter resistant steel back for the most demanding of applications

Bi-Metal

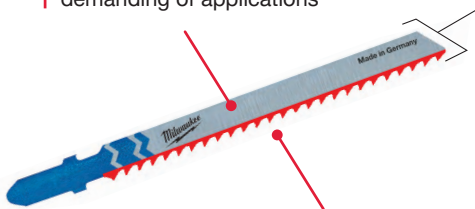

High speed steel teeth with extra hard cutting edge

Blade colour code

Shank colour means application



= For all types of wood, laminated chipboard, chipboard, plywood, blockboard and plastics. Silver colour blade body.



= For all types of ferrous and non-ferrous metals, steel, aluminium, brass, copper, stainless steel, lead, tin and sandwich materials. Silver colour blade body.



= For cutting a range of products, carton, rubber, fibreglass, foam and abrasive materials. Black colour blade body.













= Bi-Metal blades come with a white body and then the corresponding colour shank; yellow for wood and blue for metal.



Jigsaw blades for wood and plastic

Traditional blades

Traditional blades that deliver good and solid performance.

Blade length (mm)	Tooth pitch (mm)	Ref. No.									Pack quantity	Min. order quantity	Article Number	EAN Code		
2743 53 																
50	2	T 119 B	< 20	-	< 20	Yes	-	No	No	No	5	1	4932274353	4002395301553		
2540 71 																
75	3	T 111 C	5 - 50	-	< 40	-	Yes	No	No	No	5	1	4932254071	4002395301539		



Curve cutting blades

All of our curve cutting blades are characterised by a narrow blade body for improved manoeuvrability.

Jigsaw blade 4932265312 and 4932430143 has cutting teeth on both sides.





The teeth on the back of the blade allows one to cut tight and acute curves with simplicity.

For best results work without pendulum action when cutting tight curves.

3460 78 																
50	1.35	T 101 A0	< 20	< 20	< 15	Yes	No	Yes	No	No	5	1	4932373392	4002395348879		
2746 50 																
50	2	T 119 B0	< 20	-	< 20	Yes	No	Yes	No	No	5	1	4932274650	4002395301485		
4301 43 																
75	2.5	Curve	< 30	< 20	< 20	Yes	No	Yes	No	Yes	5	1	4932430143	4002395378043		
2653 12 																
75	4 / 1.2	Special	< 30	-	< 30	No	Yes	Yes	No	No	5	1	4932265312	4002395301478		
3460 78 																
75	4	T 244 D	< 50	-	-	No	Yes	Yes	No	Yes	5	1	4932346078	4002395312375		
											25	1	4932373492	4002395349920		

Fast cut blades

The sharp and aggressive tooth geometry is ideal for very fast cutting of wood.

2131 16 																	
75	4	T 144 D	< 50	-	-	No	Yes	No	No	Yes	5	1	4932213116	4002395301492			
											25	1	4932373487	4002395349272			
											100	1	4932430461	4002395381227			
3733 91 																	
Bi-Metal	75	4	T 144 DF	< 50	-	-	No	Yes	No	No	Yes	5	1	4932373391	4002395348862		
3116 33 																	
105	4	T 344 D	< 80	-	-	No	Yes	No	No	Yes	5	1	4932311633	4002395301508			
3547 45 																	
155	4	T 744 D	5-125	-	-	No	Yes	No	No	Yes	5	1	4932354745	4002395324095			

Fast and clean cutting blades

Triple sharpened tooth geometry for fast and super clean splinter free cuts. Plunge tip for fast plunging.

Blade length (mm)	Tooth pitch (mm)	Ref. No.											Pack quantity	Min. order quantity	Article Number	EAN Code		
4301 41																		
91	2.5	T 234 X	3 - 60	3 - 60	Yes	< 45	No	No	Yes	No			5	1	4932430141	4002395378029		

3 cut

Clean and splinter free cutting blades

The following blades have diagonally sharpened side teeth resulting in a very clear splinter free cut.

2540 61																		
75	2.5	T 101 B	< 30	< 60	No	< 30	Yes	No	No	No			5	1	4932254061	4002395301522		
													25	1	4932373489	4002395349296		
3733 90																		
75	2.5	T 101 BF	< 30	< 60	No	< 30	Yes	No	No	No			5	1	4932373390	4002395348855		
2743 51																		
75	4	T 101 D	< 50	< 60	No	< 45	Yes	No	No	No			5	1	4932274351	4002395301515		
													25	1	4932373490	4002395349906		
3993 06																		
105	3	T 301 CD	< 80	< 60	No	-	Yes	No	No	No			5	1	4932399306	4002395359202		
105	4	T 301 DL	< 80	< 80	No	< 50	Yes	No	No	No			5	1	4932346071	4002395312399		
3460 71																		

Bi-Metal

Precise straight cutting blades: Kitchen worktops

The following blades benefit from a thicker blade body guaranteeing extra stiffness and consequently a more accurate vertical cut. Ideal for those applications where a true square cut is necessary - i.e. kitchen worktops.

3730 80																		
75	4	T 101 DP	< 60	< 60	No	< 45	Yes	No	No	Yes			5	1	4932373080	4002395346073		
3733 88																		
105	4	T 101 DP sp.	< 80	< 80	No	< 50	Yes	No	No	Yes			5	1	4932373388	4002395348831		

Special application: Kitchen worktops / laminated chipboard

These blades have a reversed tooth design, this means that the blade cuts on the downward stroke making them extremely suitable for clean and splinter free cuts in laminated chipboard and especially kitchen worktops in situ.

For best results work without pendulum action.

3460 79																		
75	2.5	T 101 BR	< 30	< 60	No	< 60	Yes	No	No	No			5	1	4932346079	4002395312382		
3480 72																		
105	2.5	T101BR sp.	< 50	< 80	No	< 80	Yes	No	No	No			5	1	4932348072	4002395313860		

Special application: Laminated flooring / parquet flooring

















Blade 4932373392 is ideally suited for cutting curves and irregular shapes. Use blade 4932373083 for straight cuts.

3733 92																		
50	1.35	T 101 A0	< 20	No	< 20	< 15	Yes	No	Yes	No			5	1	4932373392	4002395348879		
3730 83																		
60	1.9	Special	3 - 20	Yes	Yes	-	Yes	No	No	No			5	1	4932373083	4002395346080		

Jigsaw blades for metal

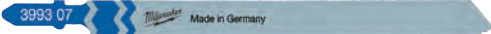

Traditional blades

Blade reference 4939274652 is especially suited to cutting very thin sheet material because of its low 0.7 mm tooth pitch. For those professionals desiring extra lifetime and durability we recommend the use of Bi-Metal blades in conjunction with a suitable cooling lubricant, the blades lifetime is double that of non Bi-Metal blades.

Blade length (mm)	Tooth pitch (mm)	Ref. No.									Pack quantity	Min. order quantity	Article Number	EAN Code		
2746 52  Made in Germany																
55	0.7	T 118 G	0.5 - 2	0.5 - 2	-	-	-	-	-	-	No	5	1	4932274652	4002395301621	
2540 63  Made in Germany																
55	1.2	T 118 A	1.5 - 4	1.5 - 4	-	-	-	-	-	-	No	5	1	4932254063	4002395301614	
340011  BI-METAL Made in Germany																
Bi-Metal 55	1.2	T 118 AF	1.5 - 4	1.5 - 4	-	1.2 - 2	-	-	-	-	No	5	1	4932340011	4002395304684	
3458 26  Made in Germany																
66	1.2	T 118 A sp.	1.5 - 4	1.5 - 4	-	-	-	-	-	-	No	5	1	4932345826	4002395313464	
3993 07  Made in Germany																
105	1	T 318 A	1 - 4	1 - 4	< 85	-	-	-	-	-	No	5	1	4932399307	4002395359219	
2540 64  Made in Germany																
55	2	T 118 B	3 - 6	3 - 6	-	-	3 - 10	-	-	-	No	5	1	4932254064	4002395301591	
3400 12  BI-METAL Made in Germany																
Bi-Metal 55	2	T 118 BF	3 - 6	3 - 6	-	2 - 3	3 - 10	-	2 - 30	-	No	5	1	4932340012	4002395304691	
2746 51  BI-METAL Made in Germany																
Bi-Metal 75	2.5	T 101 A sp.	-	2 - 10	< 45	-	3 - 10	-	2 - 20	-	No	5	1	4932274651	4002395301577	

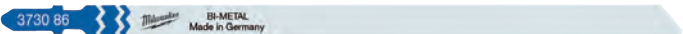

Universal application blades

These blades are suitable for cutting a wide variety of materials ranging from mild steel, aluminium, wood with nails, plastics and sandwich composites. Blade 4932373086 with its extra length (155 mm) is suitable for cutting thick corrugated sandwich material.

4301 42  BI-METAL TWIN-CUT Made in Germany																
Bi-Metal TWIN CUT 91	2.5 / 1.8	T 123 XF	2.5 - 10	3 - 10	< 50	-	4 - 10	-	-	-	No	5	1	4932430142	4002395378036	
2746 54  BI-METAL Made in Germany																
Bi-Metal 105	1.2	T 318 AF	1.5 - 4	1.5 - 4	< 85	-	-	-	-	-	No	5	1	4932274654	4002395301607	
2746 53  BI-METAL Made in Germany																
Bi-Metal 105	2	T 318 BF	3 - 6	3 - 6	< 85	-	3 - 10	4 - 30	-	-	No	5	1	4932274653	4002395301584	
3730 86  BI-METAL Made in Germany																
Bi-Metal 155	1	T 718 AF	1 - 4	1 - 4	< 125	-	-	-	-	-	No	5	1	4932373086	4002395346097	

Curve cutting blades

Especially narrower saw blade body allows one to cut tight curves in a range of metallic materials.

3460 82  Made in Germany																
55	1.2	T 218 A	1.5 - 4	1.5 - 4	-	-	-	-	-	-	Yes	5	1	4932346082	4002395312368	
3460 81  Made in Germany																
75	3	T 227 D	3.5 - 6	3.5 - 6	-	-	4 - 15	4 - 30	-	-	Yes	5	1	4932346081	4002395312351	

Special application: Aluminium

Most traditional blades are also capable of cutting aluminium, however these two blades benefit from a larger tooth pitch and wider gullets offering better material removal which is an advantage when cutting aluminium.

When cutting curves or irregular shapes in aluminium we recommend the use of blade 4932346081.

Blade length (mm)	Tooth pitch (mm)	Ref. No.								Pack quantity	Min. order quantity	Article Number	EAN Code		
2743 15 <small>Made in Germany</small>															
75	3	T 127 D	3.5 - 6	3.5 - 6	-	-	4 - 15	4 - 30	5	1	4932274315	4002395301560			

Special application: Stainless steel

This blades teeth consist of a carbide tipped strip making it the most suitable and durable blade for steels with a high alloy content such as stainless steel.

For best results work without pendulum action and use cutting oil as a lubricant.

3733 93 <small>Made in Germany</small>															
50	1.1	T 118 AHM	1.5 - 3	1.5 - 3	-	1.5 - 3	-	-	2	1	4932373393	4002395348886			

Jigsaw blades for special materials

Special applications: Fibreglass / reinforced plastics / acrylic glass

Blade 4932373387 has tungsten carbide teeth for longer lifetime in hard materials such as fibreglass.

Blade length (mm)	Tooth pitch (mm)	Ref. No.										Pack quantity	Min. order quantity	Article Number	EAN Code			
2746 51 <small>BI-METAL Made in Germany</small>																		
75	2.5	T 101 A sp.	2 - 10	-	No	No	-	2 - 20	-	No	-	No	5	1	4932274651	4002395301577		
3993 08 <small>Made in Germany</small>																		
75	4.2	T 141 HM	-	-	No	No	5 - 20	-	5 - 20	No	-	Yes	1	1	4932399308	4002395359226		
3733 87 <small>Made in Germany</small>																		
105	4.2	T 341 HM	-	< 60	No	No	5 - 20	-	5 - 20	No	-	No	1	1	4932373387	4002395348824		

Special application: Abrasive materials / cast iron

2132 31 <small>Made in Germany</small>																		
54	Grain 30	T 130 Coarse grit	-	-	Yes	Yes	< 15	-	-	Yes	5 - 15	No	1	1	4932213231	4002395301645		
2122 32 <small>Made in Germany</small>																		
54	Grain 50	T 150 Fine	-	-	Yes	Yes	< 10	-	-	Yes	5 - 15	No	1	1	4932213232	4002395301652		

Special application: Insulation material

Blade length (mm)	Tooth pitch (mm)	Ref. No.					Pack quantity	Min. order quantity	Article Number	EAN Code		
4301 44												
155	Wave knife	T 313 AW	Yes	Yes	Yes	Yes	5	1	4932430144	4002395378050		

Jigsaw blade sets - T-Shank reception

Description	Pack quantity	Min. order quantity	Article Number	EAN Code
① Jigsaw blades set (5pc) - suitable for applications in wood and metal Jigsaw blade 4932213116, 4932254061, 4932254063, 4932254064, 4932254071	5	1	4932345825	4002395314850
② Jigsaw blades set (35pc) - suitable for applications in wood and metal Contents: 7 x 4932213116 - T144D wood fast cut, 7 x 4932274351 - T101D wood clean cut, 7 x 4932254061 - T101B wood extra clean cut, 7 x 4932346078 - T244D wood fast curve cut, 7 x 4932254063 - T118A metal	35	12	4932479088	4058546368821



System accessories - Jigsaws

Description	HD18 JS/JSB BST 18 X Li JS 120 x JSPE 135 TX STEP 1200 BX/X JSPE 90 X FSPE 11 X BSPE 110 QX STEP 800 X ST 800 XE V28 JSB	STEP 70 STEP 75 ST 700 E STEP 90 X STEP 100 X FSPE 100 XL BSPE 100 XL	Pack quantity	Min. order quantity	Article Number	EAN Code
① Gliding shoe for materials with delicate surfaces	•		1	1	4932430356	4002395380176
	•		1	1	4932430834	4002395384969



U-Shank jigsaw blades

Blade length (mm)	Tooth pitch (mm)	Ref. No.							Pack quantity	Min. order quantity	Article Number	EAN Code		
75	4	A 2202	5 - 60	< 60	-	No	Yes	Yes	5	1	4932354508	4002395321070		
75	2.5	A5035/A5041	< 30	< 60	< 30	Yes	No	No	5	1	4932354506	4002395321056		



Nothing but **HEAVY DUTY.**[™]

STARLOCK

OSCILLATING MULTI-TOOL BLADES

NO COMPONENTS OR ADAPTORS REQUIRED

FAST BLADE CHANGES

100% POWER TRANSMISSION FROM TOOL TO ACCESSORY

ONE UNIVERSAL SYSTEM

WHY MILWAUKEE[®]?

- 1 **BEST LIFETIME & DURABILITY**
- 2 **ALL-TRADE FOCUSED SOLUTIONS**
- 3 **FULLY-STACKED COMPREHENSIVE RANGE**
- 4 **OVER 22 OMT PRODUCTS IN THE RANGE**



CARBIDE EXTREME

Multi Material 35mm plunge cut carbide toothed blade for extra long-life (30X more life than standard blades).

48906040

30x MORE CUTS

CARBIDE EXTREME

Description	Soft Wood	Hard Wood	Plastic	Wood+Nails	Metal	Grout	Tile Adhesive	Pack quantity	ART.#
Wood 35mm plunge cut blade.	✓		✓					1	48906001
Wood 35mm plunge cut blade with 3 cut tooth geometry for fast and clean cuts.	✓	✓	✓					1	48906011
Wood 65mm wide plunge cut blade.	✓		✓					1	48906005
Wood 65mm wide plunge cut blade with 3 cut tooth geometry for fast and clean cuts.	✓	✓	✓					1	48906015
Wood 35mm plunge cut Bi-Metal blade for long-life and 3 cut tooth geometry for fast and clean cuts.	✓	✓	✓					1	48906017
Wood with nails 20mm narrow plunge cut Bi-Metal blade for long-life.	✓		✓	✓				1	48906000
Wood with nails 35mm plunge cut Bi-Metal blade for long-life.	✓		✓	✓				1	48906021
Wood with nails 65mm plunge cut Bi-Metal blade for long-life.	✓		✓	✓				1	48906027
Multi Material 28mm plunge cut Bi-Metal blade for long-life.	✓	✓	✓	✓	✓			1	48906031
Multi Material 43mm plunge cut Bi-Metal blade for long-life.	✓	✓	✓	✓	✓			1	48906035
Multi Material 35mm plunge cut carbide toothed blade for extra long-life (30X more life than standard blades).	✓	✓	✓	✓	✓			1	48906040
Multi Material 85mm diameter segmented flush cut blade.	✓	✓	✓	✓	✓			1	48906038
Multi Material 100mm diameter segmented flush cut Bi-Metal blade for long-life.	✓	✓	✓	✓	✓			1	48906039
Grout removal 2.2mm thick carbide grit blade. For removing damaged grout between wall or floor tiles.						✓		1	48906051
Grout removal 1.2mm thick carbide grit blade. For removing damaged grout between wall or floor tiles.						✓		1	48906050
Grout removal 2.2mm thick diamond grit blade for extra long life. For removing damaged grout between wall or floor tiles. 5x more life than carbide grout blades.						✓		1	48906053
Grout removal 1.2mm thick diamond grit blade for extra long life. For removing damaged grout between wall or floor tiles. 5x more life than carbide grout blades.						✓		1	48906052
Rasp with carbide grit for rough sanding and smoothing of tile adhesive, mortar and wood.	✓						✓	1	48906054
Firm scraper for removal of hard residues like hard adhesives, tile adhesives, concrete residues and old paint.							✓	1	48906062

SANDING

Sanding pad with 6 holes, hook and loop fixation.

48906070



Description	GRIT	Pack quantity	ART.#
Perforated sanding discs for wood, paint, lacquer and plaster 93x93x3mm.	60	6	48906071
	80	6	48906072
	120	6	48906073
	180	6	48906074
	220	6	48906075

Multi-Tool accessories - STARLOCK reception

STARLOCK universal blade reception makes MILWAUKEE® blades compatible with the most popular oscillating tools.

Wood cutting blades

Description	Width (mm)	Length (mm)	Soft wood	Hard Wood	Plastics	Wood with Nails	Metal channel and profiles	Pack quantity	Min. order quantity	Article Number	EAN Code
① Wood 35 mm plunge cut blade	35	42	✓		✓			1	1	48906001	045242600298
								10	1	48906004	045242600281
② Wood 35 mm plunge cut blade with 3 cut tooth geometry for fast and clean cuts	35	42	✓	✓	✓			1	1	48906011	045242600304
								10	1	48906014	045242600311
								50	1	48906511	045242739974
③ Wood 65 mm wide plunge cut blade	65	42	✓		✓			1	1	48906005	045242600274
								50	1	48906505	045242739943
④ Wood 65 mm wide plunge cut blade with 3 cut tooth geometry for fast and clean cuts	65	42	✓	✓	✓			1	1	48906015	045242600328
⑤ Wood 35 mm plunge cut Bi-Metal blade for long life and 3 cut tooth geometry for fast and clean cuts	35	42	✓	✓	✓			1	1	48906017	045242600335
								10	1	48906019	045242600342



Multi material cutting blades

Description	Width (mm)	Length (mm)	Soft wood	Hard Wood	Plastics	Wood with Nails	Metal channel and profiles	Pack quantity	Min. order quantity	Article Number	EAN Code
① Wood with nails 20mm narrow plunge cut Bi-Metal blade for long life	20	34	✓	✓	✓	✓		1	1	48906000	045242670673
② Wood with nails 35 mm plunge cut Bi-Metal blade for long life	35	42	✓	✓	✓	✓		1	1	48906021	045242600359
								10	1	48906024	045242600366
								50	1	48906521	045242739929
③ Wood with nails 65 mm plunge cut Bi-Metal blade for long life	65	42	✓		✓	✓		1	1	48906027	045242600373
								50	1	48906527	045242739950
④ Multi Material 28 mm plunge cut Bi-Metal blade for long life	28	47	✓	✓	✓	✓	✓	1	1	48906031	045242600380
								10	1	48906034	045242600397
								50	1	48906531	045242739936
⑤ Multi Material 43 mm plunge cut Bi-Metal blade for long life	43	47	✓	✓	✓	✓	✓	1	1	48906035	045242600403
⑥ Multi Material 35 mm plunge cut carbide toothed blade for extra long life (30x life than standard blades)	35	32	✓	✓	✓	✓	✓	1	1	48906040	045242600458
⑦ Multi Material 85 mm diameter segmented flush cut blade	85	20	✓	✓	✓	✓	✓	1	1	48906038	045242600410
⑧ Multi Material 100 mm diameter segmented flush cut Bi-Metal blade for long life	100	28	✓	✓	✓	✓	✓	1	1	48906039	045242600427



Grout removal and rasping blades

Description	Width (mm)	Length (mm)	Grout	Tile adhesive	Pack quantity	Min. order quantity	Article Number	EAN Code
① Grout removal 2.2 mm carbide grit blade. For removing damaged grout between wall or floor tiles	75	20	✓		1	1	48906051	045242600441
② Grout removal 1.2 mm carbide grit blade. For removing damaged grout between wall or floor tiles	75	20	✓		1	1	48906050	045242600434
③ Grout removal 2.2 mm diamond grit blade for extra long life. For removing damaged grout between wall or floor tiles	90	25	✓		1	1	48906053	045242600489
④ Grout removal 1.2 mm diamond grit blade for extra long life. For removing damaged grout between wall or floor tiles	75	25	✓		1	1	48906052	045242600465
⑤ Rasp with carbide grit for rough sanding and smoothing of tile adhesive, mortar and wood	80	80		✓	1	1	48906054	045242600496



Scraping and cutting blades

Description	Width (mm)	Length (mm)	Tile adhesive	Adhesives	Carpet	Silicon / Acrylic	Pack quantity	Min. order quantity	Article Number	EAN Code
① Flexible scraper for removal of soft residues like silicone, acrylic, carpet adhesive and old paint	52	37		✓		✓	1	1	48906061	045242600540
② Firm scraper for removal of hard residues like hard adhesives, tile adhesives, concrete residues and old paint	52	37	✓	✓	✓		1	1	48906062	045242600557
③ Flexible cutter/scraper for silicone and soft window putty material	70	-				✓	1	1	48906063	045242600564
④ Knife with 3 cutting edges. For cutting carpet, PVC flooring, cardboard and roofing felt	40	-			✓		1	1	48906060	045242600519



Sanding / polishing / cleaning

Description	Width (mm)	Length (mm)	Pack quantity	Min. order quantity	Article Number	EAN Code
① Sanding pad 93 x 93 mm - Hook & Loop	93	93	1	1	48906070	045242600571
		Grit				
Sanding paper pack (6pc) - Hook & Loop		60	6	1	48906071	045242600588
Sanding paper pack (6pc) - Hook & Loop		80	6	1	48906072	045242600595
② Sanding paper pack (6pc) - Hook & Loop		120	6	1	48906073	045242600601
Sanding paper pack (6pc) - Hook & Loop		180	6	1	48906074	045242600618
Sanding paper pack (6pc) - Hook & Loop		240	6	1	48906075	045242600632

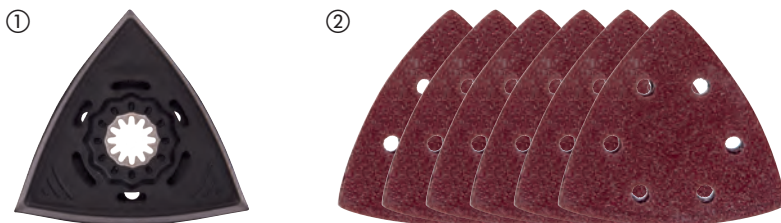

Multi-tool sets

Description	Pack quantity	Min. order quantity	Article Number	EAN Code
Wood blade set (5pc)				
① 2 x 48906001 35mm wood plunge cut blade, 2 x 48906011 35mm soft and hard wood plunge cut blade with 3 cut tooth geometry, 1 x 48906021 35mm wood and nails Bi-Metal plunge cut blade	5	12	48906114	045242670680
Wood and metal blade set (5pc)				
② 1 x 48906011 35mm soft and hardwood plunge cut blade with 3 cut tooth geometry, 2 x 48906021 35mm wood and nails Bi-Metal plunge cut blade, 2 x 48906031 28mm multi material plunge cut blade	5	12	48906115	045242670697
Renovation set (8pc)				
③ 2 x multi mat. 28mm plunge cut blade, 2 x multi mat. 43mm plunge cut blade, 1 x grout removal 2.2mm carbide blade, 1 x 3X cutting knife, 1 x rasp carbide grit, 1 x flexible scraper 52mm	8	1	48906088	045242600649
General multi-tool blade set (11pc)				
④ 2 x 35 mm plunge cut blade, 2 x 65 mm plunge cut blade, 1 x 65 mm 3C fast plunge cut blade, 2 x multi mat. 28 mm plunge cut blade, 2 x multi mat. 43 mm plunge cut blade, 1 x multi mat. 85 mm seg. flush cut blade, 1 x firm scraper 52 mm	11	1	48906090	045242600663
⑤ Multi-tool box	1	1	4932479838	4058546376321

①



②



③



④



⑤



CIRCULAR SAW BLADES

CUTS COOLER. INCREASED ACCURACY. LONGER LIFE.



SAWING, CUTTING AND GRINDING



CUTS COOLER
ANTI-FRICTION COATING



INCREASED ACCURACY
LASER CUT TECHNOLOGY

COBALT INFUSED TUNGSTEN CARBIDE TEETH
PRODUCE SHARP AND CLEAN CUTS



ALTERNATE TOOTH BEVEL



TRIPLE TOOTH CHIP AND FLAT FORM



DIAMOND FLAT TOOTH

Circular saw blades for hand held circular saws

PTFE coating: Cuts cooler, non stick for quicker cuts. Protects against corrosion and accumulation of resin.

Laser cut vibration slots: Low vibration and increased accuracy. Slots are filled with polyurethane and act as shock absorbers by isolating the teeth from vibration.

High grade laser cut steel: Guaranteed accuracy.

Premium cobalt infused tungsten carbide: Sharp and clean cuts.

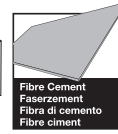
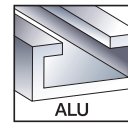
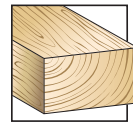

Blade diameter (mm)	Bore size (mm)	No. of teeth	Cutting width (kerf) (mm)	Hook angle	Tooth form	Thin kerf*	All wood types*	Abrasive Particleboard, Fibrecement Board, Fiberglass	Plastics	Non ferrous metals profiles alu	Fast cut	Clean Cut	Pack quantity	Min. order quantity	Article Number	EAN Code
140	20	18	1.6	+18°	ATB	✓	✓				✓		1	1	4932471310	4058546289386
160	20	24	2.2	+15°	ATB		✓				✓		1	1	4932471290	4058546289188
		48	2.2	+5°	ATB		✓					✓	1	1	4932471291	4058546289195
		52	2.2	-5°	TF				✓	✓		✓	1	1	4932471292	4058546289201
		4	2.2	+10°	D			✓			✓		1	1	4932471293	4058546289218
165	5/8"	24	1.6	+15°	ATB	✓	✓				✓		1	1	4932471311	4058546289393
		40	1.6	+18°	ATB	✓	✓					✓	1	1	4932471312	4058546289409
165	20	24	1.6	+15°	ATB	✓	✓				✓		1	1	4932471931	4058546298302
		40	1.6	+18°	ATB	✓	✓					✓	1	1	4932471932	4058546298319
		52	1.6	+2°	ATB	✓			✓	✓		✓	1	1	4932479087	4058546368814
		24	2.2	+15°	ATB		✓				✓		1	1	4932471294	4058546289225
		48	2.2	+5°	ATB		✓					✓	1	1	4932471295	4058546289232
165	30	24	1.8	+15°	ATB	✓	✓				✓		1	1	4932399909**	4002395365647
		52	2.2	-5°	TF				✓	✓		✓	1	1	4932471296	4058546289249
184	5/8"	24	1.6	+15°	ATB	✓	✓				✓		1	1	4932471378	4058546290061
		40	2.1	+15°	ATB	✓	✓					✓	1	1	4932471379	4058546290078
184	30	24	1.6	+15°	ATB	✓	✓				✓		1	1	4932471297	4058546289256
		40	2.1	+10°	ATB	✓	✓					✓	1	1	4932471298	4058546289263
		54	2.4	-5°	TF				✓	✓		✓	1	1	4932471299	4058546289270
190	30	24	1.6	+15°	ATB	✓	✓				✓		1	1	4932471300	4058546289287
		36	1.6	+15°	ATB	✓	✓				✓		1	1	4932471301	4058546289294
		48	2.1	+10°	ATB	✓	✓					✓	1	1	4932471380	4058546290085
		54	2.4	-5°	TF				✓	✓		✓	1	1	4932471303	4058546289317
210	30	4	1.8	+10°	D			✓			✓		1	1	4932471304	4058546289324
		16	2.4	+15°	ATB	✓	✓				✓		1	1	4932471324	4058546289522
235	30	48	2.8	+10°	ATB	✓	✓					✓	1	1	4932471325	4058546289539
		24	2.4	+15°	ATB		✓				✓		1	1	4932471305	4058546289331
		36	2.4	+15°	ATB		✓				✓		1	1	4932471306	4058546289348
		48	2.4	+10°	ATB		✓					✓	1	1	4932471307	4058546289355
235	30	60	2.4	+10°	ATB		✓					✓	1	1	4932471308	4058546289362
		60	2.4	-5°	TF				✓	✓		✓	1	1	4932471309	4058546289379

Circular Saw Blade Twin Packs

165 x 5/8" Twin pack set (2pc) 2 x 165x5/8"x24 tooth, fast cut wood blade (4932471311)	2	1	4932479836	4058546376307
165 x 3/4" Twin pack set (2pc) 1 x 165x3/4"x24 tooth, fast cut wood blade (4932471311) + 1 x 165x3/4"x40 tooth, clean cut wood blade (4932471312)	2	1	4932479837	4058546376314
165 x 20 mm Twin pack set (2pc) 2 x 165x20x40 tooth, fast and clean cut wood blade (4932471932)	2	1	4932492433	4058546418007
190 x 30 mm Twin pack set (2pc) 1 x 190x30x24 tooth, fast cut wood blade (4932471300) + 1 x 190x30x48 tooth, clean cut wood blade (4932471380)	2	1	4932479574	4058546373689
190 x 30 mm Twin pack set (2pc) 2 x 190x30x24 tooth, fast cut wood blade (4932471300)	2	1	4932479804	4058546375980

*Thin Kerf: Cordless optimised, extra thin cutting width for maximum runtime

*All wood types: Soft/ hardwood, plywood, laminated chipboard, melamine, MDF

**Standard blades without PTFE coating and vibration slots

Circular saw blades for mitre saws

PTFE coating: Cuts cooler, non stick for quicker cuts. Protects against corrosion and accumulation of resin.
 Laser cut vibration slots: Low vibration and increased accuracy. Slots are filled with polyurethane and act as shock absorbers by isolating the teeth from vibration.
 High grade laser cut steel: Guaranteed accuracy.
 Premium cobalt infused tungsten carbide: Sharp and clean cuts.



Blade diameter (mm)	Bore size (mm)	No. of teeth	Cutting width (kerf) (mm)	Hook Angle	Tooth Form	All Wood Types*	Plastics	Non ferrous metals alu	Fast cut	Clean Cut	Pack quantity	Min. order quantity	Article Number	EAN Code	
190	30	40	2.4	-5°	ATB	✓			✓		1	1	4932471314	4058546289423	
		54	2.4	-5°	TF		✓	✓		✓	1	1	4932471303	4058546289317	
216	30	24	2.4	-5°	ATB	✓			✓		1	1	4932471315	4058546289430	
		48	2.4	-5°	ATB	✓			✓		1	1	4932471316	4058546289447	
		60	2.4	-5°	ATB	✓				✓		1	1	4932471317	4058546289454
		80	2.4	-5°	TF			✓	✓		✓	1	1	4932471319	4058546289478
250	30	40	2.8	+15°	ATB	✓			✓		1	1	4932472015	4058546324117	
		60	2.8	+15°	ATB	✓				✓		1	1	4932472016	4058546324124
254	30	60	3.0	-5°	ATB	✓			✓		1	1	4932471320	4058546289485	
		80	3.0	-5°	TF			✓	✓		✓	1	1	4932471318	4058546289461
305	30	60	3.0	-5°	ATB	✓			✓		1	1	4932471321	4058546289492	
		100	3.0	-5°	ATB	✓				✓		1	1	4932471322	4058546289508
		96	3.0	-5°	TF			✓	✓		✓	1	1	4932471323	4058546289515

Circular Saw Blade Twin Packs

216 x 30 mm Twin pack set (2pc)

1 x 216x30x48 tooth, fast cut wood blade (4932471316) + 1 x 216x30x60 tooth, clean cut wood blade (4932471317) 2 1 4932479575 4058546373696

254 x 30 mm Twin pack set (2pc)

1 x 254x30x60 tooth, fast cut wood blade (4932471320) + 1 x 254x30x80 tooth, clean cut aluminium blade (4932471318) 2 1 4932479576 4058546373702

*Thin Kerf: Cordless optimised, extra thin cutting width for maximum runtime
 *All wood types: Soft/ hardwood, plywood, laminated chipboard, melamine, MDF

Circular saw blades for table saws

PTFE coating: Cuts cooler, non stick for quicker cuts. Protects against corrosion and accumulation of resin.
 Laser cut vibration slots: Low vibration and increased accuracy. Slots are filled with polyurethane and act as shock absorbers by isolating the teeth from vibration.
 High grade laser cut steel: Guaranteed accuracy.
 Premium cobalt infused tungsten carbide: Sharp and clean cuts.



**Standard blades without PTFE coating and vibration slots

Blade diameter (mm)	Bore size (mm)	No. of teeth	Cutting width (kerf) (mm)	Hook Angle	Tooth Form	Thin Kerf*	All Wood Types*	Abrasive Particle-board, Fibre-cement Board, Fiber-glass*	Plastics	Non ferrous metals alu	Fast cut	Clean Cut	Pack quantity	Min. order quantity	Article Number	EAN Code
210	30	24	1.9	+25°	ATB	✓	✓				✓		1	1	4932478095	4058546340285

*Thin Kerf: Cordless optimised, extra thin cutting width for maximum runtime
 *All wood types: Soft/ hardwood, plywood, laminated chipboard, melamine, MDF

Circular saw blades for metal

NEW

1. Engineered tooth geometry for optimum performance.
2. Top grade carbide and cermet tooth tips for superior lifetime.
3. Fully hardened and tensioned blade body for accurate cuts.
4. Deep gullets provide rapid and efficient chip removal.
5. Laser cut resin filled expansion slots for noise and vibration dampening.

- Cuts clean. Burr free edges reduce extra finishing processes.
- Cuts cool. The cut material can be handled immediately after cutting.
- Cuts fast. Quicker than all other conventional cutting methods.
- Cost cutter. Less expensive per cut than abrasive discs.
- Reduced noise.
- Reduced vibration.
- Total safety: no sparks, no coolants, cool to touch.

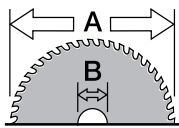

Ø mm

Blade diameter (mm)	Bore size (mm)	No. of teeth	Cutting width (kerf) (mm)	Material wall thickness (mm)	Mild steel	Sheet steel up to 2.5mm	Corrugated steel panels up to 2.5mm	Steel pipe	Stainless steel sheets	Cast iron	Copper	Aluminium	Rebar	Sandwich material (steel, foam, panels)	Pack quantity	Min. order quantity	Article Number	EAN Code
135	20	30	1.6	1-2.5	✓	✓	✓	✓	✦	✗	✗	✗	✗	✓	1	1	48404070	045242233786
		50	1.6	1-2.5	✗	✗	✗	✗	✗	✗	✓	✓	✗	✦	1	1	48404075	045242233793
150	20	34	1.6	>2.5	✓	✓	✓	✓	✦	✗	✗	✓	✗	✓	1	1	48404080	045242510283
165	5/8"	48	1.6	1-2.5	✓	✓	✓	✓	✗	✗	✗	✗	✗	✓	1	1	48404220	045242569069
174	20	36	1.6	1-2.5	✓	✓	✓	✓	✗	✗	✗	✗	✗	✗	1	1	48404225	045242569052
		42	1.8	>2.5	✓	✗	✗	✓	✗	✗	✗	✗	✗	✗	1	1	48404515	045242134465
203	5/8"	50	1.8	1-2.5	✓	✓	✓	✓	✦	✗	✗	✗	✗	✓	1	1	48404520	045242134472
		58	2.4	>2.5	✗	✗	✗	✗	✗	✗	✓	✓	✗	✦	1	1	48404345	045242569113
		70	1.6	0.5-1.5	✓	✓	✓	✓	✦	✗	✗	✗	✓	✓	1	1	4932478815*	4058546360979

- ✓ Most suitable. Recommended for these materials.
- ✦ Suitable. Recommended for intermittent use in these materials.
Very good cutting characteristics, but greatly reduced lifetime of the blade.

✗ Not suitable. Not recommended for these materials.

Optimising Blade Life

1. Clamp the workpiece securely to avoid vibration.
2. Do NOT stack or bundle cutting material. The gaps between layers allow for more opportunities to chip the teeth.
The life of the blade is severely affected by this type of cutting.
3. Lower the blade to its maximum cutting capacity and allow the tool to come to full speed before applying the blade to the material.
4. Do NOT force the saw blade into the material. Start gently, then gradually apply enough pressure to avoid sparks.
5. Optimal cutting speed and pressure will produce little or no sparks. Sparking creates heat build up which shortens saw blade life.
6. Keep the cut straight. If following a cut line and you wander off the line, getting back on line may cause side loading of the blade and break teeth. Use an edge guide whenever possible.
7. Do NOT apply side pressure on the blade as this will cause chipping of the teeth.
8. Periodically allow the tool to run free of the cutting material to cool the blade and tool especially when making long cuts or cuts in thick material.



Bandsaw blades

Choosing the right tooth geometry

8/10 Tpi Tooth pitch 2.3/1.8 mm	10 Tpi Tooth pitch 2.5 mm	12/14 Tpi Tooth pitch 1.8/1.4 mm	14 Tpi Tooth pitch 1.8 mm	18 Tpi Tooth pitch 1.4 mm	25 Tpi Tooth pitch 1 mm
FOR CUTTING STOCK 5 to 13 mm	FOR CUTTING STOCK 8 to 13 mm	FOR CUTTING STOCK 4 to 8 mm	FOR CUTTING STOCK 5 to 8 mm	FOR CUTTING STOCK 4 to 5 mm	FOR CUTTING STOCK < 4 mm



Premium Bi-Metal bandsaw blades

Multi pitch Bi-Metal blades with matrix II high speed steel teeth with 8% cobalt outlast conventional blades up to 3 times, requiring fewer blade changes.

Precision formed teeth create fast, clean cuts.

Optimised for cordless bandsaws: More cuts per charge.

Suitable for cutting: Angle iron, galvanised pipe and even tougher steels such as cast iron and stainless steel.



Premium bandsaw blade 1139.83 x 12.7 x 0.51 mm (Corded & M18 Deep Cut)

Material wall thickness (mm)	Tooth pitch (mm)	Teeth per inch	Pack quantity	Min. order quantity	Article Number	EAN Code
5 - 13	3.1 / 2.5	8 / 10	3	1	48390601	045242530298
			25	1	48390605	045242539697
4 - 8	2.1 / 1.8	12 / 14	3	1	48390611	045242530328
			25	1	48390615	045242539703



Premium bandsaw blade 898.52 x 12.7 x 0.51 mm (M18 Compact)

Material wall thickness (mm)	Tooth pitch (mm)	Teeth per inch	Pack quantity	Min. order quantity	Article Number	EAN Code
5 - 13	3.1 / 2.5	8 / 10	3	1	48390609	045242536412
			25	1	48390606	045242537754
4 - 8	2.1 / 1.8	12 / 14	3	1	48390619	045242536429
			25	1	48390616	045242537761



Premium bandsaw blade 687.57 x 12.7 x 0.51 mm (M12 Sub Compact)

Material wall thickness (mm)	Tooth pitch (mm)	Teeth per inch	Pack quantity	Min. order quantity	Article Number	EAN Code
4 - 8	2.1 / 1.8	12 / 14	3	1	48390711	045242536436



Premium bandsaw blade 776.29 x 12.7 x 0.51 mm (M12 Sub Compact)

Material wall thickness (mm)	Tooth pitch (mm)	Teeth per inch	Pack quantity	Min. order quantity	Article Number	EAN Code
4-8	2.1/1.8	12/14	3	1	48390631	045242605125
			25	1	48390636	045242605132
5-13	3.1/2.5	8/10	3	1	48390630	045242605156
			25	1	48390635	045242605163



Bi-Metal bandsaw blades

Suitable for cutting: Angle iron, galvanised pipe and even tougher steels such as cast iron and stainless steel.

Bandsaw blade 1139.83 x 12.7 x 0.51 mm (Corded & M18 FUEL[™])

Material wall thickness (mm)	Tooth pitch (mm)	Teeth per inch	Pack quantity	Min. order quantity	Article Number	EAN Code
≥ 8	2.5	10	3	1	48390501	045242132096
5 - 8	1.8	14	3	1	48390511	045242132164
4 - 5	1.4	18	3	1	48390521	045242132263
≤ 4	1.0	25	3	1	48390531	045242132362

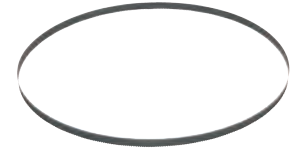

Bandsaw blade 898.52 x 12.7 x 0.51 mm (M18)

Material wall thickness (mm)	Tooth pitch (mm)	Teeth per inch	Pack quantity	Min. order quantity	Article Number	EAN Code
5 - 8	1.8	14	3	1	48390519	045242201594
4 - 5	1.4	18	3	1	48390529	045242201747
≤ 4	1.0	25	3	1	48390539	045242201815

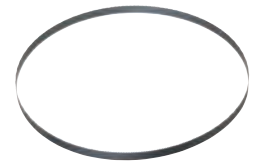

Bandsaw blade 687.57 x 12.7 x 0.51 mm (M12)

Material wall thickness (mm)	Tooth pitch (mm)	Teeth per inch	Pack quantity	Min. order quantity	Article Number	EAN Code
2.5 - 8	1.4	18	3	1	48390572	045242272341



SPEEDCROSS

MILWAUKEE® SPEEDCROSS DIAMOND BLADES ARE ENGINEERED FOR ALL CONSTRUCTION SITE PROFESSIONALS WHO DEMAND ONLY THE BEST IN PERFORMANCE WHEN WORKING IN THE TOUGHEST ENVIRONMENTS.

Segments
High diamond concentration with special aggressive geometry gives a high cutting performance. Laser welded segments for 100% user safety.

Precision engineered blade body
Pre-tensioned and hardened blade body for perfect concentration and maximum resistance to heat build up.

Cool cutting slots
The slots and holes improve the airflow keeping the cutting temperature of the segments to a minimum. This safeguards the segments from heat damage and allows the user to cut more and quicker.

Noise reduction qualities
Perfect balance and concentration suppress cutting noise.

Low vibration
The tensioned blade body eliminates wobble and minimises vibration.

Ø 350 x 25,4 mm
max. 5.400 rpm
max. 100 m/s
EN 13236
4932 4719 87

Milwaukee Ø 350 x 25,4 mm max. 5.400 rpm max. 100 m/s

AUDD 350

4 002396 298869

SAWING, CUTTING AND GRINDING



DIAMOND PREMIUM BLADES
MAXIMUM SPEED AND LIFETIME!

Speedcross Blades

SPEEDCROSS

MAXIMUM SPEED, LONG LIFE, LOW VIBRATION!

- Universal blades for a variety of materials
- Classed into two categories for maximum lifetime
- Laser welded segments for best performance
- Low vibration



**HUDD
HARD
UNIVERSAL**



**AUDD
ABRASIVE
UNIVERSAL**



**ADD
ASPHALT
DISC**

Application areas

The Speedcross blades are both universal in application but their best performance is achieved at different ends of the spectrum. The HUDD is predominantly a blade for very hard to medium-hard general building materials, the harder the material the better the performance. Alternatively the AUDD is most suitable for hard materials to soft/abrasive materials, its best performance is achieved when used in standard hardness concrete and general building materials.

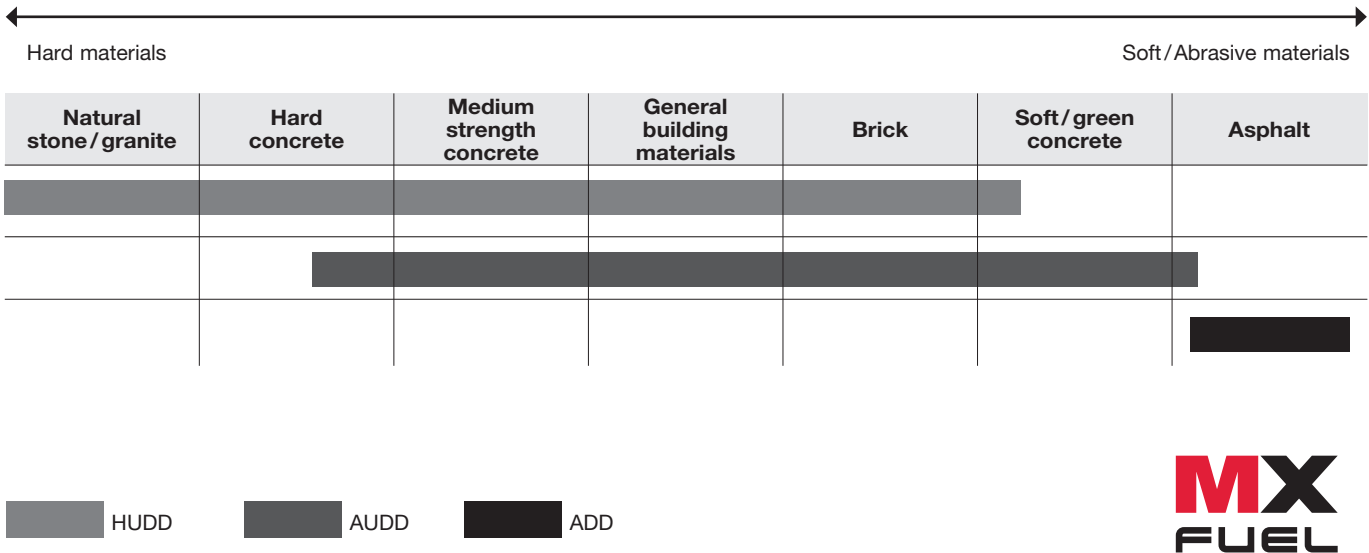

Speedcross diamond blades make the perfect match for the MX FUEL 350mm Cut Off Saw

Premium Speedcross XHUDD

NEW

Suitable for all kinds of hard building materials.
Up to 13 mm segment height (350 mm) for longest life.
Precise positioned and arranged diamonds for best cutting performance.
Laser welded short tooth segments for extremely aggressive cutting.

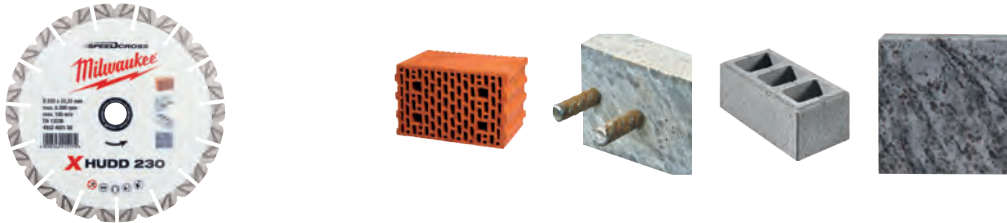

Type	Disc diameter (mm)	Bore size (mm)	Segment height (mm)	Cutting width (mm)	Pack quantity	Min. order quantity	Article Number	EAN Code
X-HUDD 115	115	22.23	12	2.6	1	1	4932492147	4058546415143
X-HUDD 125	125	22.23	12	2.6	1	1	4932492148	4058546415150
X-HUDD 150	150	22.23	12	2.6	1	1	4932492149	4058546415167
X-HUDD 230	230	22.23	15	2.6	1	1	4932492150	4058546415174
X-HUDD 350	350	25.4	14	2.6	1	1	4932492151	4058546415181

Speedcross SUDD

NEW

Silent technology to reduce the noise level whilst cutting.
U-grooved segments for best dust removal and faster cutting.
Precise positioned and arranged diamonds for best cutting performance.
Laser welded segments with distinct stamped pattern to reduce heat build up.

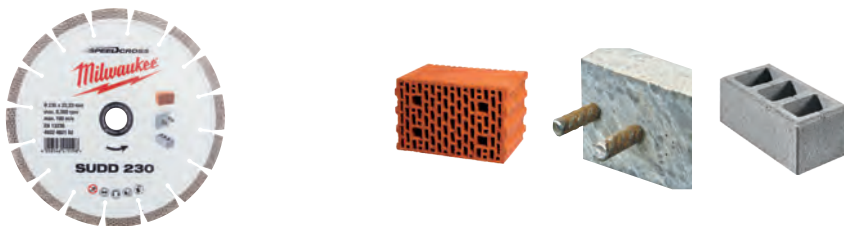

Type	Disc diameter (mm)	Bore size (mm)	Segment height (mm)	Cutting width (mm)	Pack quantity	Min. order quantity	Article Number	EAN Code
SUDD 230	230	22.23	15	3.4	1	1	4932492152	4058546415198
SUDD 350	350	25.4	15	3.4	1	1	4932492153	4058546415204

Speedcross HUDD

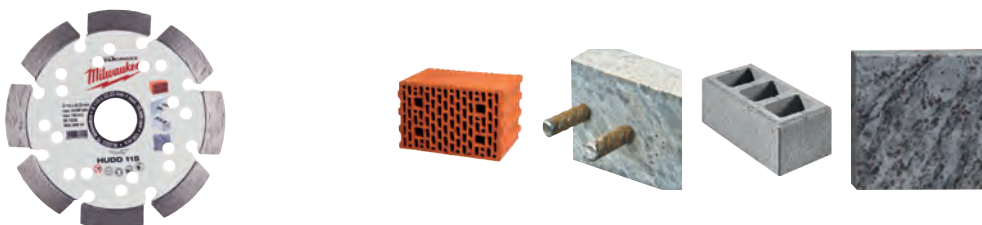

Type	Disc diameter (mm)	Bore size (mm)	Segment height (mm)	Cutting width (mm)	Pack quantity	Min. order quantity	Article Number	EAN Code
HUDD 115	115	22.23	10	2.6	1	1	4932399819	4002395364749
HUDD 125	125	22.23	10	2.6	1	1	4932399820	4002395364756
HUDD 150	150	22.23	10	2.6	1	1	4932399821	4002395364763
HUDD 230	230	22.23	10	2.6	1	1	4932399822	4002395364770
HUDD 350	350	25.4	8	2.6	1	1	4932471985	4058546298845

Speedcross AUDD



*For Speedcross AUDD 350mm only

Type	Disc diameter (mm)	Bore size (mm)	Segment height (mm)	Cutting width (mm)	Pack quantity	Min. order quantity	Article Number	EAN Code
AUDD 115	115	22.23	10	2.6	1	1	4932399823	4002395364787
AUDD 125	125	22.23	10	2.6	1	1	4932399824	4002395364794
AUDD 150	150	22.23	10	2.6	1	1	4932399825	4002395364800
AUDD 230	230	22.23	10	2.6	1	1	4932399826	4002395364817
AUDD 350*	350	25.4	10	2.6	1	1	4932471987	4002396298869

Speedcross STEELHEAD[™]

STEELHEAD[™] is most suitable for steel and stainless steel. Also suitable for heavily reinforced concrete

High density of special brazed diamonds ensure a very aggressive cutting progress

Due to the versatility and the outstanding performance the diamond disc is also perfect for fire brigades and for rescue operations

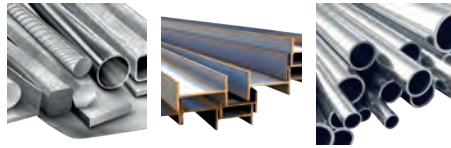

Type	Disc diameter (mm)	Bore size (mm)	Segment height (mm)	Cutting width (mm)	Pack quantity	Min. order quantity	Article Number	EAN Code
STEELHEAD [™] 115	115	22.23	4	2.8	1	1	4932492014	4058546413811
STEELHEAD [™] 125	125	22.23	4	2.8	1	1	4932492015	4058546413828
STEELHEAD [™] 230	230	22.23	4	2.8	1	1	4932492016	4058546413835
STEELHEAD [™] 350	350	25.4	4	2.8	1	1	4932471988	4058546298876

Speedcross DHTi

NEW

Continuous turbo rimmed blade for extremely clean and accurate cuts.

Very clean cutting blade for granite, artificial stone and especially for hard (gres/porcelain) tiles up to 20mm thickness.

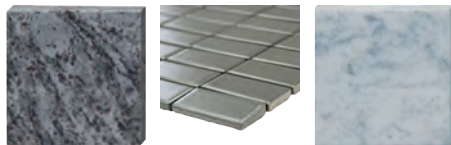

Type	Disc diameter (mm)	Bore size (mm)	Segment height (mm)	Cutting width (mm)	Pack quantity	Min. order quantity	Article Number	EAN Code
DHTi 115	115	22.23	10	2.3	1	1	4932492154	4058546415211
DHTi 125	125	22.23	10	2.3	1	1	4932492155	4058546415228
DHTi 230	230	22.23	10	2.3	1	1	4932492156	4058546415235

Speedcross DHMM

A brazed diamond disc designed for a wide range of applications.

Outstanding cutting performance due to extremely high diamond concentration.

Suitable for a vast variety of material like PVC, granite, tiles, hard artificial stone, composite material, drywall, thin wood, threaded rods and sheet metal.

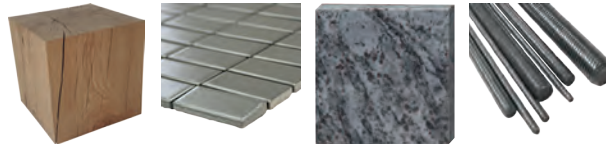

Type	Disc diameter (mm)	Bore size (mm)	Segment height (mm)	Cutting width (mm)	Pack quantity	Min. order quantity	Article Number	EAN Code
DHMM 76	76	10	2.2	1.2	1	1	4932471333	4058546289614

Speedcross ADD

NEW

ADD is most suitable for asphalt.

Double tensioned core for an improved durability and better stability whilst cutting.

Angled, special wear-retardant segments to avoid a segment tear-off.

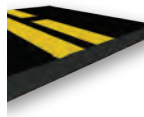

Type	Disc diameter (mm)	Bore size (mm)	Segment height (mm)	Cutting width (mm)	Pack quantity	Min. order quantity	Article Number	EAN Code
ADD 350 mm	350	25.4	10	2.8	1	1	4932478952	4058546362348

Diamond blades SUDD

NEW

A laser welded quality blade with exceptional performance in hard materials such as hard concrete, block paviers and masonry products.

Silent technology to reduce the noise level whilst cutting.

10 mm segment height.

Perfect match to the MILWAUKEE® cut-off saws.



Type	Disc diameter (mm)	Bore size (mm)	Segment height (mm)	Cutting width (mm)	Pack quantity	Min. order quantity	Article Number	EAN Code
SUDD 230 mm	230	22.23	10	3.0	1	1	4932479463	4058546372576
SUDD 350 mm	350	25.4	10	3.1	1	1	4932479462	4058546372569

Diamond blades DUH

A trade laser welded quality blade with exceptional performance in hard materials such as hard concrete, block paviors and masonry products.



Type	Disc diameter (mm)	Bore size (mm)	Segment height (mm)	Cutting width (mm)	Pack quantity	Min. order quantity	Article Number	EAN Code
DUH 115	115	22.23	10	2.2	1	1	4932399539	4002395361861
DUH 125	125	22.23	10	2.3	1	1	4932399540	4002395361878
DUH 180	180	22.23	10	2.4	1	1	4932399541	4002395361885
DUH 230	230	22.23	10	2.6	1	1	4932399542	4002395361892
DUH 350	350	25.4	10	2.8	1	1	4932471986	4058546298852

Diamond blades DSU

A trade quality universal blade, specially designed for hard and abrasive materials.

Laser welded segments provide long lifetime and excellent cutting performance. Recommended for use with wall chasers.



Type	Disc diameter (mm)	Bore size (mm)	Segment height (mm)	Cutting width (mm)	Pack quantity	Min. order quantity	Article Number	EAN Code
DSU 125	125	22.23	10	2.4	1	1	4932373147	4002395346455
DSU 150	150	22.23	10	2.4	1	1	4932373148	4002395346462

Diamond blades DU

A general purpose blade offering good performance in speed and lifetime in a wide variety of construction materials.



Type	Disc diameter (mm)	Bore size (mm)	Segment height (mm)	Cutting width (mm)	Pack quantity	Min. order quantity	Article Number	EAN Code
DU 115	115	22.23	10	2.2	1	1	4932399521	4002395361687
DU 125	125	22.23	10	2.3	1	1	4932399522	4002395361694
DU 180	180	22.23	10	2.4	1	1	4932399523	4002395361700
DU 230	230	22.23	10	2.6	1	1	4932399524	4002395361717

Diamond blades DHTi

Specifically designed turbo rimmed blade for clean cut edges in ceramic tiles and thin natural stone tiles / slabs.

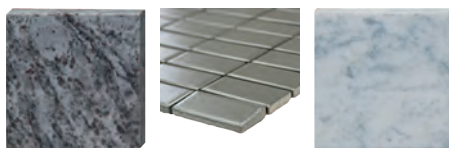

Type	Disc diameter (mm)	Bore size (mm)	Segment height (mm)	Cutting width (mm)	Pack quantity	Min. order quantity	Article Number	EAN Code
DHTi 115	115	22.23	8	2.0	1	1	4932399552	4002395361991
DHTi 125	125	22.23	8	2.1	1	1	4932399553	4002395362004
DHTi 230	230	22.23	8	2.6	1	1	4932399555	4002395362028

Diamond blades DUT

A general purpose turbo rimmed blade for cutting a wide variety of general building materials. The turbo rim ensures clean chip free cuts.

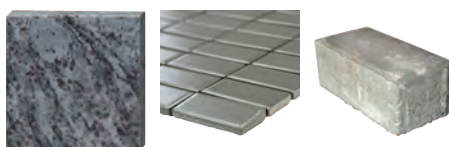

Type	Disc diameter (mm)	Bore size (mm)	Segment height (mm)	Cutting width (mm)	Pack quantity	Min. order quantity	Article Number	EAN Code
DUT 115	115	22.23	10	2.2	1	1	4932399526	4002395361731
DUT 125	125	22.23	10	2.3	1	1	4932399527	4002395361748
DUT 180	180	22.23	10	2.4	1	1	4932399528	4002395361755
DUT 230	230	22.23	10	2.6	1	1	4932399529	4002395361762

Diamond blades DHTS

A trade quality turbo blade with extra thin body for very fast, precise and chip free cuts in thin materials such as granite, marble slabs and tiles (type: porcelain, gres, ceramic).

Due to the high quality of this blade it is also suitable for cutting most building materials.

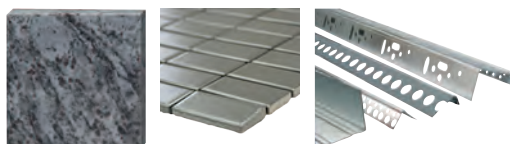

Type	Disc diameter (mm)	Bore size (mm)	Segment height (mm)	Cutting width (mm)	Pack quantity	Min. order quantity	Article Number	EAN Code
DHTS 76	76	10	5	1	1	1	4932464715	4058546226602
DHTS 115	115	22.23	10	1.2	1	1	4932399145	4002395357550
DHTS 125	125	22.23	10	1.2	1	1	4932399146	4002395357567
DHTS 230	230	22.23	10	1.9	1	1	4932399550	4002395361977

Diamond blades: Which diamond cutting blade for which material?

Material	Type	Speedcross Premium			Professional					
		HUDD	AUDD	STEEL-HEAD [™]	DU	DUT	DUH	DHTS	DHTi	DSU
Abrasive refractory materials		◆	✓							
Aerated concrete/breeze blocks		◆	✓		✓	✓	✓			◆
Artificial stone		✓				✓	✓			✓
Artificial stone – hard		✓				✓	✓	◆		✓
Asphalt			◆							
Basalt		✓	✓			✓	✓			✓
Brick – very hard, engineering brick		✓				◆	✓			✓
Brick – medium to hard		✓			◆	◆	✓			✓
Brick – medium to soft		✓	✓		◆	◆	◆			✓
Concrete – hard		✓	◆	◆		✓				✓
Concrete – medium		✓	✓		✓	✓	✓			✓
Concrete – soft/green		◆	✓							◆
Concrete with flint aggregate		◆	✓							
Concrete with flint and rebar		◆	✓							
Concrete kerbstones		✓	✓	◆			✓			✓
Concrete lintels		✓	◆			✓				✓
Concrete block paviors		✓	✓		◆	◆	✓			✓
Concrete tiles		✓	✓		✓	✓	✓	◆		✓
Concrete reinforced with rebar		✓	◆	◆	◆	◆	✓			✓
Concrete slabs		✓	◆				✓			✓
Concrete slabs with aggregate		✓	✓			◆	✓			✓
Fireclay		✓	✓				✓			✓
General building materials		✓	✓	◆	✓	✓	✓			✓
Gneiss		✓					◆			◆
Granite		✓				✓	✓			✓
Granite tiles/slabs		◆				✓	◆	✓		◆
Lime/sandstone blocks – hard		✓	✓				✓			✓
Lime/sandstone blocks – medium		✓	✓		◆	◆	✓			
Lime/sandstone – soft/abrasive		◆	✓		◆	◆	◆			◆
Marble tiles/slabs		◆				✓	◆	✓	◆	✓
Metal channel/profiles								◆		
Poroton		✓	✓		✓	✓	✓			✓
Porphyry		✓				◆	✓	✓		✓
Roof tiles – clay		✓	◆		◆	✓	◆	✓		✓
Roof tiles – concrete		✓	✓			✓	◆	✓		✓
Screed		◆	✓		◆	◆	◆			◆
Slate		✓	◆		◆	✓	✓	✓		◆
Stoneware/clay tiles		✓	✓			✓	✓			✓
Tiles – ceramic						◆		✓	✓	
Tiles – porcelain and gres type						◆		✓	◆	
Tiles – terrazo type		✓	◆			✓	✓	✓		✓

✓ Most suitable. Recommended for these materials. Very long service life and very good cutting characteristics.

◆ Suitable. Recommended for intermittent use in these materials. Good service life and cutting characteristics.

Combi-segment diamond cup wheels

For quick grinding down of thick concrete layers, abrasive materials or special substances.

For levelling of concrete, granite and natural stone surfaces.

For edge grinding applications e.g. grinding off high edges of concrete, granite, natural stone tiles.

For roughening prior to covering with a new layer of coating.

High quality diamonds and special soft bonding for low wear, especially in hard materials.



Type	Diameter (mm)	Bore size (mm)	No. of segments	Cup wheel height [mm]	Segment height (mm)	Pack quantity	Min. order quantity	Article Number	EAN Code
SDCWU 100									
① Premium universal wheel for grinding and levelling applications. Highest stock removal.	100	22.23	16	21	5	1	1	4932430080	4002395377411
SDCWU 125									
② Premium universal wheel for grinding and levelling applications. Highest stock removal.	125	22.23	16	21	5	1	1	4932430081	4002395377428
SDCWA 125									
③ Universal wheel for grinding and levelling applications. High stock removal. For abrasive materials.	125	22.23	16	21	5	1	1	4932479093	4058546368876
Fine SDCWSF 125									
④ Premium wheel with diamond pads for removal of special substances: thermoplastics and epoxy based coatings, acrylic paint, glue, tile adhesive, screed, plaster.	125	22.23	Diamond Pads	21	3.3	1	1	4932479094	4058546368883
Coarse SDCWSC 125									
⑤ PCD segment for removal of special substances: thermoplastic and epoxy based coatings, acrylic paint, glue, tile adhesive, screed, plaster	125	22.23	6	18.5	4 / 7	1	1	4932451188	4002395138760
DCWU 100									
⑥ Universal wheel for grinding and levelling applications. High stock removal	100	22.23	16	21	5	1	1	4932451185	4002395138739
DCWU 125									
⑦ Universal wheel for grinding and levelling applications. High stock removal	125	22.23	20	21	5	1	1	4932451186	4002395138746
DCWUT 125									
⑧ Turbo type segment for levelling, edge grinding and for smooth finishing. Fine finish for concrete and natural stone	125	22.23	Turbo	21	5	1	1	4932451187	4002395138753
SDCWUG 125									
⑨ Premium universal diamond grinding wheel for: hard artificial stone, porcelain tiles, ceramics, granite, marble, wood, hard plastics, steel.	125	22.23	-	13.3	-	1	1	4932480219	4058546405045

	SDCWU 100	SDCWU 125	SDCWA 125	Fine SDCWSF 125	Coarse SDCWSC 125	DCWU 100	DCWU 125	DCWUT 125	DCWS 125	SDCWUG 125
Acrylic paint and coatings				✓	✓				✓	✓
Aerated and breeze concrete blocks	✓	✓	✓			✓	✓	✓		
Bitumen				✓	✓				✓	
Concrete hard	✓	✓	◆			✓	✓	✓		
Concrete soft or green	◆	◆	✓			◆	◆	◆		
Epoxy resin coatings and glues									✓	✓
Granite	◆	◆				◆	◆	◆		✓
Lime and sandstone blocks hard	✓	✓	◆			✓	✓	✓		
Lime and sandstone blocks soft and abrasive	◆	◆	✓			◆	◆	◆	◆	
Marble	◆	◆	◆			◆	◆	◆		✓
Plasterboard	◆	◆	✓			◆	◆	◆		
Porphyry	◆	◆	◆			◆	◆	◆		
Screed	◆	◆	✓	✓	✓			◆		✓
Thermoplastic protective paint, glue				✓	✓				✓	✓
Tile adhesive	◆	◆	✓			◆	◆	◆	✓	◆

✓ Most suitable.

◆ Suitable - for intermittent use.

System accessories - Wall chasers

AUDD blade is a perfect solution for 80% of wall chaser applications.

- 30% less loading on the machine compared to the MILWAUKEE® DU blade.

- 40% higher speed of cut compared to the MILWAUKEE® DU blade.

SPEEDCROSS

	① HUDD	② AUDD	③ DSU
Abrasive refractory materials	◆	✓	
Aerated and breeze concrete blocks	◆	✓	◆
Brick medium to soft	✓	✓	✓
Concrete medium	✓	✓	✓
Concrete reinforced with rebar	✓	◆	✓
Concrete with flint and rebar	◆	✓	
Fireclay	✓	✓	✓
General building materials	✓	✓	✓
Granite	✓		✓
Lime and sandstone blocks soft and abrasive	◆	✓	◆
Lime and sandstone blocks medium	✓	✓	
Screed	◆	✓	◆

✓ Maximum performance

◆ Limited suitability - recommended for intermittent use



Description	Fits wall chasers	Pack quantity	Min. order quantity	Article Number	EAN Code
Transport case for wall chasers	MFE 1500, MFE 1305, MF 1900	WCE 30,WCS 45, DME 30,DME 45	1	1	4932383357 4002395357390
④ Two hole spanner straight	MFE 1500, MFE 1305, MF 1900	DME 30,DME 45, WCS 45,DME 65, WCE 65,WCE 30	1	1	4932367712 4002395338467
⑤ T-handle key	MFE 1500, MFE 1305, MF 1900	WCE 30,WCS 45, WCE 65,DME 30, DME 45,DME 65	1	1	4931362928 4002395661879
Dust protection grille against entry of ground particles	MFE 1500, MFE 1305, MF 1900	WCE 30,WCS 45, DME 30,DME 45	1	1	4932329397 4002395303892
⑥ Dust protection grille against entry of ground particles		WCE 65,DME 65	2	1	4932326525 4002395303311
Adaptor with bayonet fitting for direct connection of hose to machine	MFE 1500, MFE 1305, MF 1900	WCE 30,WCS 45, WCE 65,DME 30, DME 45,DME 65	1	1	4932362778 4002395334285
⑦ Side handle	MFE 1500, MFE 1305, MF 1900	WCE 30,WCS 45, DME 30,DME 45	1	1	4932409546 4002395370870
Flange nut	MFE 1305	DME 1300	1	1	4932334667 4002395304448
Clamping flange	MFE 1305	DME 1300	1	1	4932334706 4002395304455
Spacer set. Contents 6 rings	MFE 1305		6	1	4931334675 4002395762804

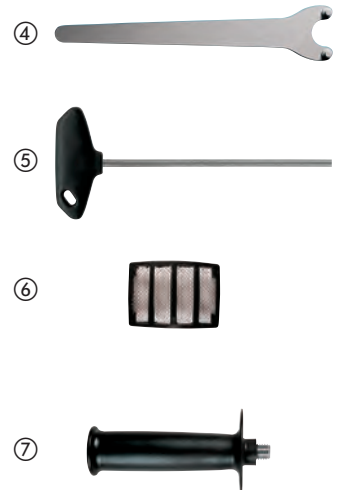

Cutting and grinding discs

MILWAUKEE® Type - how to find the right disc

Material		Application		Design		Diameter	
S = Steel	C = Stone	C = Cutting	G = Grinding	flat 41	mm	inches	
		CS = Cutting Slim	L = Flap	depressed 42	100	4	
		LC = Flap Ceramic	CT = Cutting Thin	depressed 27	115	4½	
				flap 50	125	5	
					150	6	
					180	7	
					230	9	
					350	14	



Extended life and moisture protection with PRO+**

Special mixture delivers:

Up to 20% longer lifetime vs. MILWAUKEE® contractor series.

Up to 20% less dust development vs. MILWAUKEE® contractor series.

The new formula HydroProtect prevents the age-related loss of performance and still provides almost the entire performance after months of storage.

Benefits:

Reduced costs per cut and shorter set up times.

Reduction of wheel deterioration during the storage interval.

Longer lasting high-performance.

**available on cutting and grinding discs with thickness 1, 1.5, 1.9 and 6 mm.

**+
20%
LIFETIME***

*vs. MILWAUKEE® contractor series



Thin metal cutting discs PRO+

Applications: Iron and sulphur free top line thin cut-off wheels for all steels. Best suitable for stainless (except the 350 x 4 mm) and acid-resistant steel, hardox, heat-resistant cast steel, spring steel, mild and tool steel.

Characteristics: 50% less cutting time and 50% less dust than standard 3 mm thick discs. Lower material loss.



Type	Disc diameter (mm)	Thickness (mm)	Bore size (mm)	Pack quantity	Min. order quantity	Article Number	EAN Code	
41	SCS 41 / 76	76	1	10	5	1	4932464717	4058546226626
	SCS 41 / 115	115	1	22.2	1	50	4932451484	4002395163953
①	Counter display (200 x SCS 41 / 115 discs)				200	1	4932451485	4002395163960
	SCS 41 / 115	115	1.5	22.2	1	50	4932451486	4002395163977
	SCS 41 / 125	125	1	22.2	1	50	4932451487	4002395163984
①	Counter display (200 x SCS 41 / 125 discs)				200	1	4932451488	4002395163991
	SCS 41 / 150	150	1.5	22.2	1	25	4932471386	4058546290146
	SCS 41 / 180	180	1.5	22.2	1	25	4932451489	4002395161300
	SCS 41 / 230	230	1.9	22.2	1	25	4932451490	4002395161317
	SCS 41 / 350	350	4	25.4	1	10	4932471989	4058546298883
②	SCS 41 / 115	115	1	22.2	10	1	4932478997	4058546362799
③	SCS 41 / 125	125	1	22.2	10	1	4932478998	4058546362805

*Orders are only possible in master cartons. Order quantities greater than the pack quantity are to be ordered in multiples (i.e. 50, 100, 150...)

Metal cutting discs PRO+

Applications: Great performance in cutting mild steel with medium strength, plain alloy tool steel, concrete reinforcing iron and steel rebar.
 Characteristics: Efficient cutting properties in combination with high performance.

	Type	Disc diameter (mm)	Thickness (mm)	Bore size (mm)	Pack quantity	Min. order quantity	Article Number	EAN Code
41	SC 41 / 115	115	3	22.2	1	25	4932451491	4002395161324
	SC 41 / 125	125	3	22.2	1	25	4932451492	4002395161331
	SC 41 / 180	180	3	22.2	1	25	4932451493	4002395161348
	SC 41 / 230	230	3	22.2	1	25	4932451494	4002395161362
42	SC 42 / 115	115	3	22.2	1	25	4932451495	4002395161379
	SC 42 / 125	125	3	22.2	1	25	4932451496	4002395161393
	SC 42 / 180	180	3	22.2	1	25	4932451497	4002395162000
	SC 42 / 230	230	3	22.2	1	25	4932451498	4002395162017

*Orders are only possible in master cartons. Order quantities greater than the pack quantity are to be ordered in multiples (i.e. 50, 100, 150...)

Metal cutting discs for chop saws PRO+

Applications: For structural steels, tool steel, cast iron, hard high-grade steels and concrete reinforcing steel bars (rebar).
 Characteristics: Soft cutting wheel for chop saws.

	Type	Disc diameter (mm)	Thickness (mm)	Bore size (mm)	Pack quantity	Min. order quantity	Article Number	EAN Code
41	SC 41 / 355	355	2.5	25.4	1	10	4932451505	4002395162086

*Orders are only possible in master cartons. Order quantities greater than the pack quantity are to be ordered in multiples (i.e. 50, 100, 150...)

Metal grinding discs PRO+

Applications: Sound performance in mild steel and non alloy tool steel.
 Characteristics: Provides good lifetime and efficient grinding characteristics.

	Type	Disc diameter (mm)	Thickness (mm)	Bore size (mm)	Pack quantity	Min. order quantity	Article Number	EAN Code
27	SG 27 / 115	115	6	22.2	1	25	4932451501	4002395162048
	SG 27 / 125	125	6	22.2	1	25	4932451502	4002395162055
	SG 27 / 150	150	6	22.2	1	10	4932471387	4058546290153
	SG 27 / 180	180	6	22.2	1	10	4932451503	4002395162062
	SG 27 / 230	230	6	22.2	1	10	4932451504	4002395162079

*Orders are only possible in master cartons. Order quantities greater than the pack quantity are to be ordered in multiples (i.e. 50, 100, 150...)

Thin metal cutting discs - contractor series

Applications: Iron and sulphur free thin cut-off wheels for steel.
 Suitable for acid-resistant steel, hardox, high-alloy steel, mild and tool steel.
 Not suitable for stainless steel.



	Type	Diameter (mm)	Thickness (mm)	Bore size (mm)	Pack quantity	Min. order quantity	Article Number	EAN Code
41	SCS 41 / 115	115	1	22.2	1	50	4932451474	4002395163250
①	Counter display (200 x SCS 41 / 115 discs)				200	1	4932451475	4002395163267
	SCS 41 / 115	115	1.5	22.2	1	50	4932451476	4002395163274
	SCS 41 / 125	125	1	22.2	1	50	4932451477	4002395163281
①	Counter display (200 x SCS 41 / 125 discs)				200	1	4932451478	4002395163298
	SCS 41 / 125	125	1.5	22.2	1	25	4932451479	4002395163908
	SCS 41 / 230	230	1.9	22.2	1	25	4932451480	4002395163915
②	SCS 41 / 125	125	1	22.2	10	1	4932459164	4002395287192

*Orders are only possible in master cartons. Order quantities greater than the pack quantity are to be ordered in multiples (i.e. 50, 100, 150...)

Metal grinding discs - contractor series

Applications: suitable for mild steel. Not suitable for stainless steel.

	Type	Diameter (mm)	Thickness (mm)	Bore size (mm)	Pack quantity	Min. order quantity	Article Number	EAN Code
27	SG 27 / 115	115	6	22.2	1	25	4932451481	4002395163922
	SG 27 / 125	125	6	22.2	1	25	4932451482	4002395163939
	SG 27 / 230	230	6	22.2	1	10	4932451483	4002395163946

*Orders are only possible in master cartons. Order quantities greater than the pack quantity are to be ordered in multiples (i.e. 50, 100, 150...)

Thin ductile stone and multi material disc

Applications: Ductile iron, non-ferrous metals & stone.

* Minimum order quantity = 10 pcs. Orders > 10 pcs must be ordered in multiples of 10 (i.e. 10, 20, 30, 40)



	Type	Disc diameter (mm)	Thickness (mm)	Bore size (mm)	Pack quantity	Min. order quantity	Article Number	EAN Code
41	CCS 41 / 350	350	4	25.4	1	10	4932472264	4058546339104

Stone cutting discs PRO+

Applications: for concrete, masonry products and thin natural stone tiles.

	Type	Diameter (mm)	Thickness (mm)	Bore size (mm)	Pack quantity	Min. order quantity	Article Number	EAN Code
42	CC 42 / 115	115	3	22.2	1	25	4932451499	4002395162024
	CC 42 / 230	230	3	22.2	1	25	4932451500	4002395162031

*Orders are only possible in master cartons. Order quantities greater than the pack quantity are to be ordered in multiples (i.e. 50, 100, 150...)

Carbide Blade

Carbide blade suitable for cutting wood, plastic and plasterboard.

Diameter (mm)	Thickness (mm)	Bore size (mm)	Pack quantity	Min. order quantity	Article Number	EAN Code
76	1	10	1	1	4932464716	4058546226619
115	1	22.23	1	1	4932492376	4058546417437
125	1	22.23	1	1	4932492377	4058546417444



Flap discs CERA TURBO[™]

Maximum productivity with CERA TURBO[™], 50% faster material removal and 2x longer lifetime vs. bonded disc.

Ceramic hybrid disc: grinds steel, stainless steel.

Plastic backing pad.

Highly flexible: perfectly adjusts to working piece.

Low heat development: no metal discolouration, especially on stainless steel.

Made in Germany.

Best for ferrous metals, stainless steel V2A (1.4301) / V4A (1.4401) and non-ferrous metals (aluminium, titan, etc.),

Orders must be in multiples of 10 pcs.



Type	Disc diameter (mm)	Grit	Bore size (mm)	Backing pad material	Pack quantity	Min. order quantity	Article Number	EAN Code	
50	SLC 50 / 115	115	40	22.2	Plastic	1	10	4932472228	4058546326241
	SLC 50 / 115	115	60	22.2	Plastic	1	10	4932472229	4058546326258
	SLC 50 / 115	115	80	22.2	Plastic	1	10	4932472230	4058546326265
	SLC 50 / 125	125	40	22.2	Plastic	1	10	4932472231	4058546326272
	SLC 50 / 125	125	60	22.2	Plastic	1	10	4932472232	4058546326289
	SLC 50 / 125	125	80	22.2	Plastic	1	10	4932472233	4058546326296

Flap discs CERA TURBO[™] XL

Maximum productivity with CERA TURBO[™], 50% faster material removal and 2x longer lifetime vs. bonded disc.

CERA TURBO[™] XL with 10 mm protruding flaps for grinding down fillet welds.

Ceramic hybrid disc: grinds steel, stainless steel.

Natural fibre backing pad.

Highly flexible: perfectly adjusts to working piece.

Low heat development: no metal discolouration, especially on stainless steel.

Best for ferrous metals, stainless steel V2A (1.4301) / V4A (1.4401) and non-ferrous metals (aluminium, titan, etc.),

Orders must be in multiples of 10 pcs.

Made in Germany.



Type	Disc diameter (mm)	Grit	Bore size (mm)	Backing pad material	Pack quantity	Min. order quantity	Article Number	EAN Code	
50	SLC XL 50 / 115	115	40	22.2	Natural fibre	1	10	4932478946	4058546362287
	SLC XL 50 / 115	115	60	22.2	Natural fibre	1	10	4932478947	4058546362294
	SLC XL 50 / 115	115	80	22.2	Natural fibre	1	10	4932478948	4058546362300
	SLC XL 50 / 125	125	40	22.2	Natural fibre	1	10	4932478949	4058546362317
	SLC XL 50 / 125	125	60	22.2	Natural fibre	1	10	4932478950	4058546362324
	SLC XL 50 / 125	125	80	22.2	Natural fibre	1	10	4932478951	4058546362331

Flap discs Zirconium

High quality zirconium grain: longer lifetime on ferrous metals and stainless steel.
 Suitable for ferrous metals, stainless steel V2A (1.4301) / V4A (1.4401).
 Natural fibre backing pad: low vibration & noise, no harmful dust.
 Highly flexible: perfectly adjusts to working piece.
 Made in Germany.
 Orders must be in multiples of 10 pcs.

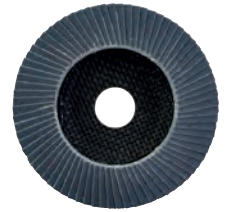

Type	Disc diameter (mm)	Grit	Bore size (mm)	Backing pad material	Pack quantity	Min. order quantity	Article Number	EAN Code	
50	SL 50 / 115	115	40	22.2	Natural Fibre	1	10	4932472220	4058546326166
	SL 50 / 115	115	60	22.2	Natural Fibre	1	10	4932472221	4058546326173
	SL 50 / 115	115	80	22.2	Natural Fibre	1	10	4932472222	4058546326180
	SL 50 / 115	115	120	22.2	Natural Fibre	1	10	4932472223	4058546326197
	SL 50 / 125	125	40	22.2	Natural Fibre	1	10	4932472224	4058546326203
	SL 50 / 125	125	60	22.2	Natural Fibre	1	10	4932472225	4058546326210
	SL 50 / 125	125	80	22.2	Natural Fibre	1	10	4932472226	4058546326227
	SL 50 / 125	125	120	22.2	Natural Fibre	1	10	4932472227	4058546326234

Flap discs Aluminium

Best for aluminium, non-ferrous metals and wood.
 Special coating of the flaps prevent clogging of the disc whilst grinding aluminium, non-ferrous metals and wood.
 Self trimming backing pad: allows grinding to the last grain.
 Made in Germany.
 Orders must be multiples of 10 pcs.



Type	Disc diameter (mm)	Grit	Bore size (mm)	Backing pad material	Pack quantity	Min. order quantity	Article Number	EAN Code
ALU SLC 50 / 115	115	40	22.2	Plastic	1	10	4932479089	4058546368838
ALU SLC 50 / 115	115	60	22.2	Plastic	1	10	4932479090	4058546368845
ALU SLC 50 / 125	125	40	22.2	Plastic	1	10	4932479091	4058546368852
ALU SLC 50 / 125	125	60	22.2	Plastic	1	10	4932479092	4058546368869



FIXTEC Nut

FIXTEC: Disc changing in seconds, no extra tools required.
 Not suitable for use on angle grinders with a break or quick stop system.
 Only 8 mm thick, enabling more surface of disc on the material.
 Compatible to all manufacturers angle grinders up to Ø 150 mm with standard M14 spindle thread.
 12 seconds from removing the worn disc to fixing a new disc.
 With integrated keyholes, for removal of the nut with a standard pin spanner (Article number: 4932367712) in the event of the nut becoming too tight.



Description	Pack quantity	Min. order quantity	Article Number	EAN Code
Counter display	1	12	4932352473	4002395371327
FIXTEC nut - M14 thread				



FIXTEC Nut XL

FIXTEC: Disc changing in seconds, no extra tools required.
 For large angle grinders Ø 180 mm to Ø 230.
 Not suitable for use on angle grinders with a break or quick stop system.
 12 seconds from removing the worn disc to fixing a new disc.
 With integrated keyholes, for removal of the nut with a standard pin spanner (Article number: 4932622925) in the event of the nut becoming too tight.
 Counter display



Description	Pack quantity	Min. order quantity	Article Number	EAN Code
Counter display	1	12	4932464610	4058546225551
FIXTEC Nut for 180 & 230 mm angle grinders - M14 thread				





COATED ABRASIVES

154 NEW COATED ABRASIVES



4 NEW SETS ACROSS ALL PRODUCT TYPES

3 PERFORMANCE LEVELS

STANDARD

- PERFORATED
- ALUMINIUM OXIDE (ALOX) GRAIN
- HEAVY PAPER, ROBUST AND TEAR RESISTANT
- SEMI-OPEN GRAIN DISTRIBUTION

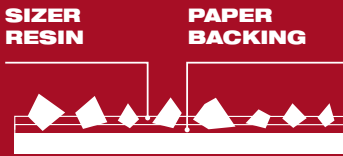

HIGH PERFORMANCE

- PERFORATED
- ALUMINIUM OXIDE (ALOX) GRAIN
- LIGHT AND MORE FLEXIBLE PAPER BACKING
- SEMI-OPEN GRAIN DISTRIBUTION
- BETTER SURFACE FINISH
- BETTER MATERIAL REMOVAL

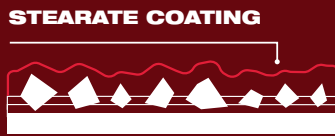

POWERGRID MESH

- OPEN MESH
- ALUMINIUM OXIDE (ALOX) GRAIN
- OPEN GRAIN DISTRIBUTION
- NO CLOGGING FOR 5X LONGER LIFE VS. STANDARD PAPER
- BEST MATERIAL REMOVAL
- BEST SURFACE FINISH
- BEST OVERALL LIFETIME



WHY USE A PAD SAVER WITH POWERGRID MESH?

PowerGrid Mesh is very aggressive and will produce 2x more dust. Dust wears and damages the Velcro on the backing pad

Pad savers are the solution to extend life of the machines backing pad

APPLICATIONS



STANDARD



✓	✓	✓	✓	✗	✗	✗	✗
---	---	---	---	---	---	---	---

HIGH PERFORMANCE



✓	✓	✗	✗	✓	✓	✓	✓
---	---	---	---	---	---	---	---

POWERGRID MESH



✓	✓	✓	✓	✓	✓	✓	✓
---	---	---	---	---	---	---	---

Sanding sheets for random orbital sanders

Mesh sanding sheets for random orbital sanders Ø125 & 150 mm

NEW

Grit	Paper size diameter (mm)	Pack quantity	Min. order quantity	Article Number	EAN Code
80	125	10	1	4932492185	4058546415525
120	125	10	1	4932492186	4058546415532
180	125	10	1	4932492187	4058546415549
240	125	10	1	4932492188	4058546415556
320	125	10	1	4932492189	4058546415563
400	125	10	1	4932492190	4058546415570
80	125	50	1	4932492203	4058546415709
120	125	50	1	4932492204	4058546415716
180	125	50	1	4932492205	4058546415723
240	125	50	1	4932492206	4058546415730
80	150	10	1	4932492220	4058546415877
120	150	10	1	4932492221	4058546415884
180	150	10	1	4932492222	4058546415891
240	150	10	1	4932492223	4058546415907
320	150	10	1	4932492224	4058546415914
400	150	10	1	4932492225	4058546415921
80	150	50	1	4932492238	4058546416058
120	150	50	1	4932492239	4058546416065
180	150	50	1	4932492240	4058546416072
240	150	50	1	4932492241	4058546416089
Mesh & Pad Saver 125 mm H&L Set 1 - 10 pcs					
Sand Disc PG Mesh: 3 x Grit 80 / 3 x Grit 120 / 3 x Grit 180, 1 x Pad Saver		10	1	4932492293	4058546416607
Mesh & Pad Saver 150 mm H&L Set 2 - 10 pcs					
Sand Disc PG Mesh: 3 x Grit 80 / 3 x Grit 120 / 3 x Grit 180, 1 x Pad Saver		10	1	4932492294	4058546416614

125 mm



150 mm

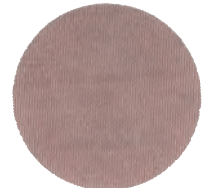

Premium HP sanding sheets for random orbital sanders Ø 125 & 150 mm

NEW

Grit	Paper size diameter (mm)	Pack quantity	Min. order quantity	Article Number	EAN Code
40	125	10	1	4932492178	4058546415457
60	125	10	1	4932492179	4058546415464
80	125	10	1	4932492180	4058546415471
120	125	10	1	4932492181	4058546415488
180	125	10	1	4932492182	4058546415495
240	125	10	1	4932492183	4058546415501
320	125	10	1	4932492184	4058546415518
40	125	50	1	4932492197	4058546415648
60	125	50	1	4932492198	4058546415655
80	125	50	1	4932492199	4058546415662
120	125	50	1	4932492200	4058546415679
180	125	50	1	4932492201	4058546415686
240	125	50	1	4932492202	4058546415693
40	150	10	1	4932492213	4058546415808
60	150	10	1	4932492214	4058546415815
80	150	10	1	4932492215	4058546415822
120	150	10	1	4932492216	4058546415839
180	150	10	1	4932492217	4058546415846
240	150	10	1	4932492218	4058546415853
320	150	10	1	4932492219	4058546415860
40	150	50	1	4932492232	4058546415990
60	150	50	1	4932492233	4058546416003
80	150	50	1	4932492234	4058546416010
120	150	50	1	4932492235	4058546416027
180	150	50	1	4932492236	4058546416034
240	150	50	1	4932492237	4058546416041

125 mm



150 mm



Sanding sheets for random orbital sanders Ø125 mm & 150mm

Crit	Paper size diameter (mm)	Pack quantity	Min. order quantity	Article Number	EAN Code
40	125	10	1	4932492172	4058546415396
60	125	10	1	4932492173	4058546415402
80	125	10	1	4932492174	4058546415419
120	125	10	1	4932492175	4058546415426
180	125	10	1	4932492176	4058546415433
240	125	10	1	4932492177	4058546415440
40	125	25	1	4932492191	4058546415587
60	125	25	1	4932492192	4058546415594
80	125	25	1	4932492193	4058546415600
120	125	25	1	4932492194	4058546415617
180	125	25	1	4932492195	4058546415624
240	125	25	1	4932492196	4058546415631
40	150	10	1	4932492207	4058546415747
60	150	10	1	4932492208	4058546415754
80	150	10	1	4932492209	4058546415761
120	150	10	1	4932492210	4058546415778
180	150	10	1	4932492211	4058546415785
240	150	10	1	4932492212	4058546415792
40	150	50	1	4932492226	4058546415938
60	150	50	1	4932492227	4058546415945
80	150	50	1	4932492228	4058546415952
120	150	50	1	4932492229	4058546415969
180	150	50	1	4932492230	4058546415976
240	150	50	1	4932492231	4058546415983

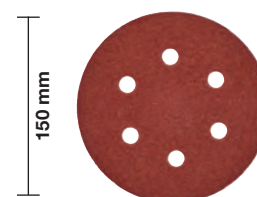
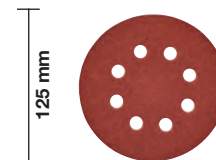

Pad saver for Mesh sanding sheets for random orbital sanders Ø125 & 150 mm

NEW

Diameter (mm)	Pack quantity	Min. order quantity	Article Number	EAN Code
125	5	1	4932492291	4058546416584
150	5	1	4932492292	4058546416591

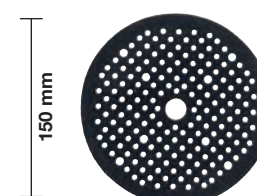
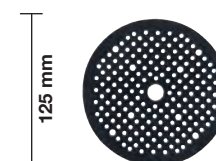

Sanding sheets for orbital sanders

Perforated sanding discs for wood, metal, paint, lacquer, plaster.

Grit type: fused alumina, half open.

Artificial resin-bonded on special tear resistant paper.

Mesh sanding sheets for orbital sanders 115 x 107 mm

NEW

Grit	Paper size A x B (mm)	Pack quantity	Min. order quantity	Min. order quantity	Article Number	EAN Code
80	115 x 107	10	1	1	4932492249	4058546416164
120	115 x 107	10	1	1	4932492250	4058546416171
180	115 x 107	10	1	1	4932492251	4058546416188
240	115 x 107	10	1	1	4932492252	4058546416195
320	115 x 107	10	1	1	4932492253	4058546416201
400	115 x 107	10	1	1	4932492254	4058546416218
Mesh 115 x 107 H&L Set - 10 pcs						
Sand Sheet PG Mesh: 4 x Grit 80 / 3 x Grit 120 / 3 x Grit 180		10	1	1	4932492295	4058546416621

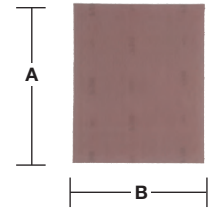

Premium HP Sanding sheets for orbital sanders 115 x 107 mm

NEW

Grit	Paper size A x B (mm)	Pack quantity	Min. order quantity	Min. order quantity	Article Number	EAN Code
80	115 x 107	10	1	1	4932492244	4058546416119
120	115 x 107	10	1	1	4932492245	4058546416126
180	115 x 107	10	1	1	4932492246	4058546416133
240	115 x 107	10	1	1	4932492247	4058546416140
320	115 x 107	10	1	1	4932492248	4058546416157

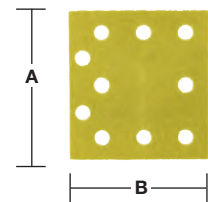

Sanding sheets for orbital sanders 115 x 107 mm

NEW

Grit	Paper size A x B (mm)	Pack quantity	Min. order quantity	Min. order quantity	Article Number	EAN Code
40	115 x 107	10	1	1	4932492242	4058546416096
60	115 x 107	10	1	1	4932492759	4058546476304
80	115 x 107	10	1	1	4932492760	4058546476311
120	115 x 107	10	1	1	4932492761	4058546476328
180	115 x 107	10	1	1	4932492243	4058546416102
240	115 x 107	10	1	1	4932492762	4058546476335

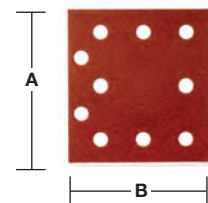

Sanding sheets for orbital sanders

Grit	Paper size A x B (mm)	Pack quantity	Min. order quantity	Article Number	EAN Code
60	80 x 133	10	1	4932492763	4058546476342
80	80 x 133	10	1	4932492764	4058546476359
120	80 x 133	10	1	4932492765	4058546476366
180	80 x 133	10	1	4932492766	4058546476373
240	80 x 133	10	1	4932492767	4058546476380
40	93 x 185	10	1	4932492257	4058546416249
60	93 x 185	10	1	4932492258	4058546416256
80	93 x 185	10	1	4932492259	4058546416263
120	93 x 185	10	1	4932492260	4058546416270
180	93 x 185	10	1	4932492261	4058546416287
240	93 x 185	10	1	4932492262	4058546416294
40	115 x 230	10	1	4932492263	4058546416300
60	115 x 230	10	1	4932492264	4058546416317
80	115 x 230	10	1	4932492265	4058546416324
120	115 x 230	10	1	4932492266	4058546416331
180	115 x 230	10	1	4932492267	4058546416348
240	115 x 230	10	1	4932492268	4058546416355

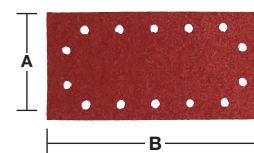
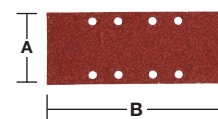
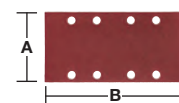

Mesh sanding sheets for M12 FDSS 67 x 92 mm

NEW

12 x longer life compared to standard sandpaper.

Open mesh structure for almost dust-free sanding and longest life. The mesh structure increases performance and reduces clogging.

Mesh sheet 67 x 92 mm for M12 Fuel Spot Sander FDSS.

Can be cleaned with compressed air, vacuumed or rinsed out with water.

Application: wood, painted wood, plastic, filler, drywall, metal, plaster, lacquer.

Each pack includes 1 pad saver. Always use a pad saver when using mesh type abrasives, this protects the tool backing pad from damage.



Grit	Paper size A x B (mm)	Pack quantity	Min. order quantity	Article Number	EAN Code
80	67 x 92	13	1	48805080	045242645299
120	67 x 92	13	1	48805120	045242645312
180	67 x 92	13	1	48805180	045242645336
220	67 x 92	13	1	48805220	045242645343
320	67 x 92	13	1	48805320	045242645350
400	67 x 92	13	1	48805400	045242645367
Sponge Interface Pad 67 x 92 mm	67 x 92	1	1	48805402	045242645381
Mesh 67 x 92 mm - 12 pc Set + Pad saver	67 x 92	13	1	48805405	045242645398



Sanding sheets for delta sanders

Mesh sanding sheets for delta sanders 93 x 93 mm

NEW

Grit	Paper size A x B (mm)	Pack quantity	Min. order quantity	Article Number	EAN Code
80	93 x 93	10	1	4932492281	4058546416485
120	93 x 93	10	1	4932492282	4058546416492
180	93 x 93	10	1	4932492283	4058546416508
240	93 x 93	10	1	4932492284	4058546416515
Mesh 93 x 93 H&L Set - 10 pcs					
Sand Disc PG Mesh: 3 x Grit 80 / 3 x Grit 120 / 3 x Grit 180, 1 x Pad Saver		10	1	4932492296	4058546416638

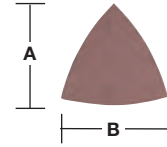

Premium HP sanding sheets for delta sanders 93 x 93 mm

NEW

Grit	Paper size A x B (mm)	Pack quantity	Min. order quantity	Article Number	EAN Code
40	93 x 93	10	1	4932492275	4058546416423
60	93 x 93	10	1	4932492276	4058546416430
80	93 x 93	10	1	4932492277	4058546416447
120	93 x 93	10	1	4932492278	4058546416454
180	93 x 93	10	1	4932492279	4058546416461
240	93 x 93	10	1	4932492280	4058546416478

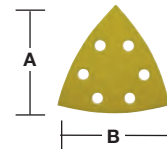

Sanding sheets for delta sanders 93 x 93 mm

Grit	Paper size A x B (mm)	Pack quantity	Min. order quantity	Article Number	EAN Code
40	93 x 93	10	1	4932492269	4058546416362
60	93 x 93	10	1	4932492270	4058546416379
80	93 x 93	10	1	4932492271	4058546416386
120	93 x 93	10	1	4932492272	4058546416393
180	93 x 93	10	1	4932492273	4058546416409
240	93 x 93	10	1	4932492274	4058546416416

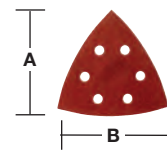

Sanding sheets for delta sanders 100 x 147 mm

Grit	Paper size A x B (mm)	Pack quantity	Min. order quantity	Article Number	EAN Code
40	100 x 147	10	1	4932492285	4058546416522
60	100 x 147	10	1	4932492768	4058546476397
80	100 x 147	10	1	4932492769	4058546476403
120	100 x 147	10	1	4932492770	4058546476410
180	100 x 147	10	1	4932492771	4058546476427
240	100 x 147	10	1	4932492772	4058546476434

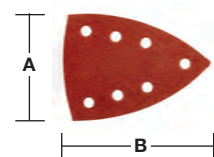

Abrasive belts

Cloth sanding belts for wood, metal, paint, lacqueur, plaster.

Grit type: fused alumina, half open.

Artificial resin-bonded on special fabric.

Sanding belts 75 x 457 mm

Grit	Paper size A x B (mm)	Pack quantity	Min. order quantity	Article Number	EAN Code
40	75 x 457	5	1	4932480546	4058546408312
60	75 x 457	5	1	4932480547	4058546408329
80	75 x 457	5	1	4932480548	4058546408336
100	75 x 457	5	1	4932480549	4058546408343
150	75 x 457	5	1	4932480550	4058546408350

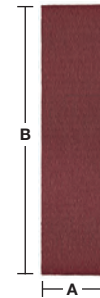

Sanding belts 75 x 533 mm

Grit	Paper size A x B (mm)	Pack quantity	Min. order quantity	Article Number	EAN Code
40	75 x 533	5	1	4932312475	4002395301263
60	75 x 533	5	1	4932312476	4002395301270
80	75 x 533	5	1	4932312477	4002395301287
100	75 x 533	5	1	4932312478	4002395301294
150	75 x 533	5	1	4932312479	4002395301300

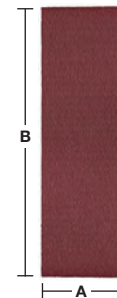

Sanding belts 100 x 560 mm

Grit	Paper size A x B (mm)	Pack quantity	Min. order quantity	Article Number	EAN Code
40	100 x 560	5	1	4932492286	4058546416539
60	100 x 560	5	1	4932492287	4058546416546
80	100 x 560	5	1	4932492288	4058546416553
100	100 x 560	5	1	4932492289	4058546416560
150	100 x 560	5	1	4932492290	4058546416577

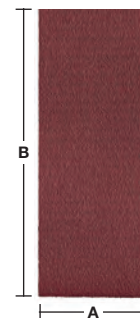

Sanding belts 100 x 610 mm

Grit	Paper size A x B (mm)	Pack quantity	Min. order quantity	Article Number	EAN Code
40	100 x 610	5	1	4932355066	4002395319824
60	100 x 610	5	1	4932355067	4002395319831
80	100 x 610	5	1	4932355068	4002395319848
100	100 x 610	5	1	4932355069	4002395319855
150	100 x 610	5	1	4932355070	4002395319862

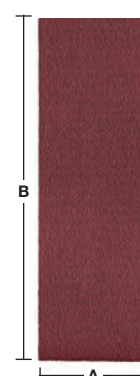

Sanding belts 100 x 620 mm

Grit	Paper size A x B (mm)	Pack quantity	Min. order quantity	Article Number	EAN Code
40	100 x 620	5	1	4932341610	4002395304882
60	100 x 620	5	1	4932341611	4002395304899
80	100 x 620	5	1	4932341612	4002395304905
100	100 x 620	5	1	4932341613	4002395304912
150	100 x 620	5	1	4932341614	4002395304929

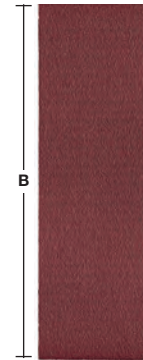

Screwdrivers - System attachments

Description	Fits MILWAUKEE® Corded Screwdrivers	Pack quantity	Min. order quantity	Article Number	EAN Code
① Drywall sleeve assembly	DWE 4000 Q, DWSE 4000 Q, TKSE 2500 Q, 6790, 6743	1	1	49261036	045242185245
② Self drill sleeve assembly	TKSE 2500 Q, 6790	1	1	49261082	045242185375
1/4" magnetic bit holder 76 mm	DWE 4000 Q, DWSE 4000 Q, 6743	1	1	48323065	045242128600
1/4" magnetic bit holder 76 mm, requires additionally 49261036 sleeve assembly	TKSE 2500 Q, 6790	1	1	48323070	045242128655
③ Hex socket driver set (3pc) Ø 6 / 8 / 10 mm magnetic sockets	TKSE 2500 Q, 6790, TQSE 1200 Q, TQSE 2500 Q, 6580, 6581	3	1	49663004	045242207848
④ Collated attachment for M18 FSG		1	1	4933459202	4002395289974
⑤ PH2 148 mm drywall screwdriving bit for M18 FSG		3	1	4932459393	4058546010546
⑥ Mag / ring drywall bit holder 75 mm for M18 FSG		1	1	4932459394	4058546010553
⑦ Offset attachment 1/4" hex M12FPDX		1	1	4932464481	4058546224264
⑧ M12 FPDx-RAA Right angle attachment for drilling and screwdriving applications in confined spaces. 90° angle. 12 fixing positions. Direct bit reception.		1	1	4932464480	4058546224257
⑨ 13 mm Keyless chuck to suit M12 FPDx sub compact percussion drill		1	1	4932464479	4058546224240
⑩ Rivet tool nose set		4	1	48540100	045242504466
⑪ 152mm Nose extension kit- for M12™ rivet tool		3	1	48950100	045242504459
⑫ M12 BDDx-OA offset attachment for screwdriving applications - 12 fixing positions		1	1	4932430432	4002395380930
⑬ M12 BDDx-RAA right angle attachment for drilling and screwdriving applications in confined spaces - 90° angle - 12 fixing positions - direct bit reception		1	1	4932430433	4002395380947
⑭ Retention nose pieces set for M18 FUEL™ rivet tool with ONE-KEY™		240	250	4932478961	4058546362430
⑮ Extension nose piece for M18 FUEL™ rivet tool with ONE-KEY™		32	100	4932478962	4058546362447



Side handles

Description	Pack quantity	Min. order quantity	Article Number	EAN Code
① Side handle with depth gauge for all drills and percussion drills with gear neck diameter 43 mm	1	1	4932373725	4002395352647
② Side handle with depth gauge for all drills and percussion drills with a short gear neck (13 mm) of diameter 43 mm	1	1	4932364149	4002395342198



QUIK-LOK™ cables

Cable length (m)	Country version	Pack quantity	Min. order quantity	Article Number	EAN Code
4	EU	1	1	4932373502	4002395351725
10	EU	1	1	4932373503	4002395351732
4	CH	1	1	4932373504	4002395351749
4	GB	1	1	4932373508	4002395351787
6	EU	1	1	4932364483 ¹	4002395337620
QUIK-LOK cable repair kit		1	1	4931380758	4002395714551



¹Heavy duty and acid resistant, non repairable

Universal right angle drill attachment

Converts MILWAUKEE® HDE 13 RQD straight drill to angle drill.

Used extensively for drilling between joists or in tight corners.

Head and handle swivel 360°.

Provides two speeds: 1. Low: speed decreases by 30% torque increases by 50% 2. High: speed increases by 50%

Description	Pack quantity	Min. order quantity	Article Number	EAN Code
Right angle drill attachment	1	1	48062871	045242088812

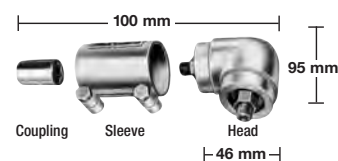

Head and handle swivel 360° and can be locked tight in any position.

Impact wrenches - System attachments















Description	Pack quantity	Min. order quantity	Article Number	EAN Code
Detent pin square type: Socket will not slip off unless detent pin is pressed in	1	1	49170405	045242178919

Description	Pack quantity	Min. order quantity	Article Number	EAN Code
Rubber Sleeve for M18 CIW	1	1	49162754	045242320455
Rubber Sleeve for M18 CHIW and M28 CHIW	1	1	49162763	045242324255
Rubber Sleeve for M18 FMTIWP	1	1	49162861	045242510146
Rubber Sleeve for M18 FHIWP12 & M18 ONEFHIWP12	1	1	49162766	045242506415
Rubber Sleeve for M18 FHIWF12, M18 ONEFHIWF12 & M18 ONEFHIWF34	1	1	49162767	045242506422
Rubber Sleeve for M18 FIW2F & M18 FW2P	1	1	4932478770	4058546360528
Rubber Sleeve for M18 ONEFHIWF1	1	1	4932478760	4058546360429
Rubber Sleeve for M18 FMTIW2F & M18 FMTIW2P	1	1	4932478771	4058546360535
Rubber Sleeve for M12 FIWF	1	1	4932478758	4058546360405
Rubber sleeve for M12 FRAIWF38 & M12 FRAIWF12	1	1	4932479098	4058546368920
Rubber sleeve for M12 FIR38	1	1	4932479100	4058546368944
Rubber sleeve for M12 FID	1	1	4932479102	4058546368968
Rubber sleeve for M18 FID2	1	1	4932479103	4058546368975
Rubber Sleeve for M18 ONEFHIWF1 (1PC)	1	1	4932479975	4058546377694



Rotary hammers - System attachments

Rotary hammer chuck adaptors

Tool Drive	Reception	Id. No. 4932	EAN Code 4002395	
① FIXTEC 	SDS-Plus	379877	346561	① 
② FIXTEC 	SDS-Plus	399152	357628	② 
③ FIXTEC 	SDS-Plus	352299	369584	③ 
④ FIXTEC 	1/2" x 20 UNF	371807	344710	④ 
⑤ FIXTEC 	1/2" x 20 UNF	399154	357635	⑤ 
⑥ SDS-Plus 	1/2" x 20 UNF	367438	337668	⑥ 
⑦ SDS-Plus 	1/2" x 20 UNF	367166	334438	⑦ 

Only suitable for PLH 16 QEX, V28 HX, V18 HX, PLH 26 QEX, PH 30 Power X, KH 26 XE, KH 24 XE, KH 28 Super XE, BH 26 LXE and PH 26 X.

Chuck adaptor with direct bit reception (1/4" Hex) to accept screwdriving bits. Threaded housing enables adaptor to be tightened to the chuck resulting in no wobble.

Chuck adaptor with retaining screw.

Keyed chucks

Chuck jaws open (mm)	Drill reception	Locking device	Safety screw	Rotary drill	Percussion drill	Battery drill	Chuck key	Pack quantity	Min. order quantity	Article Number	EAN Code
1.5-13	1/2" x 20		✓	✓	✓	✓	A	1	1	4932267980	4002395300488
3.0-16	Taper B16			✓			C	1	1	4932127010	4002395306169
3.0-16	M18x2.5	✓	✓	✓	✓		C	1	1	4932320014	4002395310784



Keyed chucks - machine specific

Chuck jaws open (mm)	Drill reception	Fits MILWAUKEE® Drill Drivers	Safety screw	Chuck key	Pack quantity	Min. order quantity	Article Number	EAN Code
1.0-10	3/8" x 24	HDE 6 RQ	✓	H	1	1	48660817	045242155705
2.0-13	1/2" x 20	HDE 13 RQD	✓	K	1	1	48661355	045242156542



Keyed chucks with 1/4" Hex reception

Chuck jaws open (mm)	Drill reception	Battery drill	Chuck key	Pack quantity	Min. order quantity	Article Number	EAN Code
1.0-10	1/4" Hex	✓	A	1	1	4932314867	4002395300112



Chuck keys

Description	Type	Ref. No.	Pack quantity	Min. order quantity	Article Number	EAN Code
① Chuck key	A	S2A	1	1	4932221378	4002395302765
	B	S2AT	1	1	4932310612	4002395309177
	C	S3T	1	1	4932221379	4002395306381
	D	S14	1	1	4932304684*	4002395300105
	E	S4	1	1	4932221380	4002395306398
	G	S2	1	1	4932319995	4002395303724
	H		1	1	48663350	045242157600
	J		1	1	48663240	045242157501
② Morse taper No. 3 adaptor for chucks with B16 taper	MT3 - B16		1	1	4932117042	4002395305834
	Ejector tool DIN 317 size 3		1	1	4932604226	4002395311248



* while stocks last

Keyless chucks

Keyless chucks 2 sleeves

Chuck jaws open (mm)	Reception	Locking device	Safety screw	Rotary drill	Percussion drill	Battery drill	Pack quantity	Min. order quantity	Article Number	EAN Code
1.0-10	3/8" x 24		✓	✓		✓	1	1	4932349457	4002395318155
1.0-10	1/2" x 20	✓	✓	✓	✓	✓	1	1	4932364382	4002395337675
1.5-13	1/2" x 20	✓		✓	✓	✓	1	1	4932376531	4002395346332
1.5-13	1/2" x 20	✓	✓	✓	✓	✓	1	1	4932376533	4002395346349
1.5-13	1/2" x 20	✓		✓	✓	✓	1	1	4932364265 ¹	4002395334056
1.5-13	1/2" x 20	✓	✓	✓	✓	✓	1	1	4932364267	4002395334070



¹ Industrial quality

Keyless chucks for FIXTEC (spindle lock) machines

Chuck jaws open (mm)	Reception	Locking device	Safety screw	Rotary drill	Percussion drill	Battery drill	Pack quantity	Min. order quantity	Article Number	EAN Code
1.0-10	3/8" x 24	✓	✓	✓	✓	✓	1	1	4932371018	4002395339365
1.0-10	1/2" x 20	✓	✓	✓	✓	✓	1	1	4932372443	4002395345458
1.5-13	1/2" x 20	✓	✓	✓	✓	✓	1	1	4932371913	4002395345366
1.5-13	3/8" x 24	✓	✓	✓	✓	✓	1	1	4932399492	4002395361137
1.5-13	9/16" x 18	✓	✓	✓	✓	✓	1	1	4932478806 ¹	4058546360887



¹ Fits M18 FDD(2)/ M18 FPD(2)

Industrial keyless chucks for corded percussion drills

Chuck jaws open (mm)	Reception	Locking device	Rotary drill	Percussion drill	Battery drill	Pack quantity	Min. order quantity	Article Number	EAN Code
1.0-13	1/2" x 20	✓	✓	✓		1	1	4932364266	4002395334063



Keyless chucks - specific tool related chucks

Chuck jaws open (mm)	Reception	Machine specific	Locking device	Rotary drill	Safety screw	Pack quantity	Min. order quantity	Article Number	EAN Code
① 1.0-10	1/2" x 20	HDE 10 RQX			✓	1	1	48661520	045242156795
① 1.5-13	1/2" x 20	HDE 13 RQX			✓	1	1	42660755	4002395891436
② 1.5-13	FIXTEC		✓	✓		1	1	4932399214	4002395358236
③ 1.0-10	FIXTEC	M12 BDDX		✓		1	1	4932430444	4002395381050



Angle grinders - System attachments

Description	Fits 115 mm angle grinders	Fits 125 mm angle grinders	Fits 150mm angle grinders	Fits 180mm angle grinders	Fits 230mm angle grinders	Pack quantity	Min. order quantity	Article Number	EAN Code
① Flange nut M14	✓	✓	✓	✓	✓	1	1	4932345628	4002395313105
② Backing flange	✓	✓	✓	✓	✓	1	1	4932449324	4002395245185
③ Two hole spanner straight	✓	✓	✓	✓	✓	1	1	4932367712	4002395338467
④ Open-ended spanner. SW 17/24	✓	✓	✓	✓	✓	1	1	4932345710	4002395307722
⑤ Cranked two hole spanner for steel wire brushes				✓	✓	1	1	4932371469	4002395342181
⑥ Dust protection grille against entry of ground particles		✓	✓	✓	✓	1	1	4932329397	4002395303892
Side handle	✓	✓	✓			1	1	4932409546	4002395370870
⑦ Anti-Vibration side handle	✓	✓	✓	✓ ¹		1	1	4932399991	4002395366507
				✓	✓	1	1	4932399992	4002395366514
Hand protection guard						1	1	4932378478	4002395347353
Flange nut set. Only for AGV 16- 180 QXC Suitable for WS 2300 (Australia version)						3	1	4932351632	4002395321636
Flange nut M14 (4932345629), backing flange (4932371404), large flange nut (4932367952)									

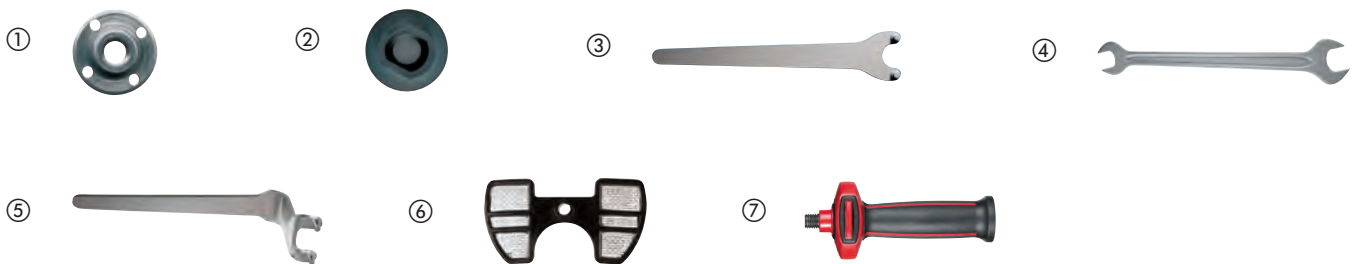

Flexible backing pads

Description	Bore size (mm)	Diameter (mm)	Fits 115 mm angle grinders	Fits 125 mm angle grinders	Fits 180mm angle grinders	Fits 230mm angle grinders	Pack quantity	Min. order quantity	Article Number	EAN Code
Flexible backing pad. Complete with flange nut M14 for all angle grinders	14.2	110	✓				1	1	4932345760	4002395313488
	14.2	125		✓			1	1	4932345761	4002395313495
	14.2	170			✓		1	1	4932345758	4002395313501
	22.2	170			✓		1	1	4932352744	4002395374021
Replacement flange nut M14			✓	✓	✓	✓	1	1	4932345627	4002395313112

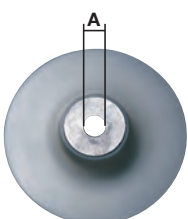

Cutting and grinding dust extraction

Description	Fits 115 mm angle grinders	Fits 125 mm angle grinders	Fits 180mm angle grinders	Fits 230mm angle grinders	Pack quantity	Min. order quantity	Article Number	EAN Code
<p>① Dust guard for cutting - DEC 125. 100% tool free connection to Ø 115 - 125 mm AG(V) 12, AGV 15 series and FUEL[™] grinders, keyless depth adjustment from 5 - 28 mm. Guide to prevent twisting during cutting. Dust guard fits to the MILWAUKEE[®] M-Class cleaners with unique „click-system“ adaptor supplied with the vacuum cleaner</p>	✓	✓			1	1	4932430467	4002395381289
<p>② Dust guard for surface conditioning - DEG 125. 100% tool free connection to Ø 125 mm AG(V) 12, AGV 15 series and FUEL[™] grinders. Supplied with additional loop handle. Removable magnetic front cover to gain access to tight corners and edges when using a cup wheel. Dust guard fits to the MILWAUKEE[®] M-Class cleaners with unique „click-system“ adaptor supplied with the vacuum cleaner. Includes replaceable brush 4931448429</p>		✓			1	1	4932430468	4002395381296
<p>③ Dust guard for cutting - DEC 230. 100% tool free connection to Ø 180 - 230mm AG 22, keyless depth adjustment from 5 - 60mm. Solid steel cutting guide to prevent twisting during cutting and flexible cutting line indicator for plunge cuts. Dust guard fits to the MILWAUKEE[®] M-Class cleaners with unique „click-system“ adaptor supplied with the vacuum cleaner.</p>			✓	✓	1	1	4932459340	4058546010010
<p>③ Dust guard for cutting - DEC 230 K. 100% tool free connection to Ø 180 - 230mm AG21, AGV 22, AG 24, AGVK 24 and FUEL[™] grinders. Does not fit to LAG's equipped with autobalancer. Keyless depth adjustment from 5 - 60mm. Solid steel cutting guide to prevent twisting during cutting and flexible cutting line indicator for plunge cuts. Dust guard fits to the MILWAUKEE[®] M-Class cleaners with unique „click-system“ adaptor supplied with the vacuum cleaner.</p>			✓	✓	1	1	4932459341	4058546010027



Die grinders - System attachments

Description	Fits MILWAUKEE® Die Grinders	Pack quantity	Min. order quantity	Article Number	EAN Code
Ø 3 mm collet	DGL 34,DGL 30 E,DG 30 E, PSG 12,PSG 14.4 PP, HD18 SG	1	1	4932308974	4002395309092
Ø 3 mm collet	M18 FDG	1	1	4932471202	4058546288303
Ø 6 mm collet	PSG 14.4 PP,HD18 SG, PSG 12,PSG 14.4 PP, DGL 30 E,DGL 34	1	1	4932313192	4002395302833
Ø 6 mm collet	DG 7 E	1	1	4931391453	4002395734818
Ø 6 mm collet	DG 14-50 Q	1	1	48660978	045242155620
Ø 8 mm collet	DGL 34,DGL 30 E,DG 30 E, PSG 12,PSG 14.4 PP, HD18 SG,V 28 SG	1	1	4932313190	4002395302840
Ø 8 mm collet	DG 7 E	1	1	4931391452	4002395734801
Ø 6.35 mm (1/4") collet	DGL 34,DGL 30 E,DG 30 E, PSG 12,PSG 14.4 PP, HD18 SG	1	1	4932313194	4002395302857
① Rubber Sleeve for M12 FDGA	M12 FDGA	1	1	4932478759	4058546360412



Plate shears - System attachments

Description	Fits MILWAUKEE® Plate Shears	Pack quantity	Min. order quantity	Article Number	EAN Code
Piston four sided blade	PPS 12	1	1	4932308837	4002395311583
Cutting table blade four sided blade	KS 2.5,S 2.5	1	1	4932430171	4002395378326
	PPS 12	1	1	4932308838	4002395309085
Centre blade	SMC 1.2 Q	1	1	48440150	045242140701
Left blade	SMC 1.2 Q	1	1	48440160	045242140756
Right blade	SMC 1.2 Q	1	1	48440170	045242140800
Socket wrench 5/16"	SMC 1.2 Q	1	1	49960070	045242221554
Replacement shear head assembly.	SMC 1.2 Q	1	1	48080500	045242089253



Nibblers - System attachments

Description	Fits nibblers	Pack quantity	Min. order quantity	Article Number	EAN Code
Punch	KN 2 PN 14.4, PN 12,N 2	1	1	4932430172	4002395378333
Die	KN 2 PN 14.4, PN 12,N 2	1	1	4932279565	4002395308521
Special die. Especially designed for cutting corrugated steel. Max. cutting capacity 1.5 mm	KN 2 PN 14.4, PN 12,N 2	1	1	4932279498	4002395308514



Polishers - System attachments

Premium Polishing Accessories - Sponges

NEW

Name	Diameter (mm)	Thickness (mm)	Pack quantity	Min. order quantity	Article Number	EAN Code
Sponge Red Coarse 140 / 20 mm	140	20	2	1	4932492310	4058546416775
Sponge Red Coarse 160 / 20 mm	160	20	2	1	4932492316	4058546416836
Sponge Yellow Fine 140 / 20 mm	140	20	2	1	4932492319	4058546416867
Sponge Blue Ultra Fine 140 / 20mm	140	20	2	1	4932492312	4058546416799
Sponge Yellow Fine 160 / 20 mm	160	20	2	1	4932492321	4058546416881
Sponge Red Coarse 140 / 25 mm	140	25	2	1	4932492318	4058546416850
Sponge Yellow Fine 140 / 25 mm	140	25	2	1	4932492311	4058546416782
Sponge Blue Ultra Fine 140 / 25 mm	140	25	2	1	4932492317	4058546416843
Sponge Blue Ultra Fine 160 / 20 mm	160	20	2	1	4932492320	4058546416874



Premium Polishing Accessories - Cloths

NEW

Name	Length (mm)	Width (mm)	Pack quantity	Min. order quantity	Article Number	EAN Code
Cloth Red 40 x 40 mm	40	40	2	1	4932492306	4058546416737
Cloth Yellow 40 x 40 mm	40	40	2	1	4932492307	4058546416744
Cloth Blue 40 x 40 mm	40	40	2	1	4932492308	4058546416751



Premium Polishing Accessories - Compounds

NEW

Name	Pack quantity	Min. order quantity	Article Number	EAN Code
Compound Red Coarse 1l	1	1	4932492300	4058546416676
Compound Yellow Fine 1l	1	1	4932492301	4058546416683
Compound Blue Ultra Fine 1l	1	1	4932492302	4058546416690



Premium - Hook & Loop Ø 125 mm

Description	Diameter (mm)	Height (mm)	Pack quantity	Min. order quantity	Article Number	EAN Code
<p>Polishing backing pad with M14 thread. Very flat design with excellent flexibility.</p> <p>① Low vibration allows precise work on any flat and curved profiles</p>	125		1	1	4932430394	4002395380558
<p>Lambswool polishing disc. 100% natural lambswool. Premium quality with extremely high fibre density for longer lifetime. Integrated soft touch layer guarantees perfect adjustment to flat and curved profiles. For finishing old and fresh paint. Extremely good polishing of temperature sensitive clear lacquers thanks to heat resistant fibres, e.g. polishing car bumper</p> <p>②</p>	135	25	1	1	4932430395	4002395380565
<p>Microfibre polishing cloth. Super-soft premium microfibre polishing cloth for finishing gloss polishing. With good absorption properties perfectly suited for final finishing and removing water spots from sensitive surfaces. Machine-washable with 30° without softener</p> <p>③</p>	400 x 400		1	1	4932430398	4002395380596



Polishing Accessories - hook & loop Ø 150 mm

Description	Diameter (mm)	Height (mm)	Pack quantity	Min. order quantity	Article Number	EAN Code
<p>Polishing backing pad. Application: Reception of felt / lambswool polishing discs and sponges.</p> <p>① Characteristics: M14 thread, break resistant with integrated soft and flexible foam layer, Hook & Loop fixation</p>	150	25	1	1	4932373161	4002395347285
<p>Felt polishing disc. Application: second polishing / finish of new lacquer work (spray mist and inclusion of dust), non ferrous metals and stainless steel, can also be used with polishing paste. Requires polishing backing</p> <p>②</p>	150	50	1	1	4932373163	4002395347902
<p>Lambswool polishing disc. Finishing high gloss polishing</p> <p>③</p>	150	25	1	1	4932373164	4002395347926
<p>Polishing sponge hard. Polish up of weather-beaten lacquer, lacquer re-conditioning</p> <p>④</p>	150	50	1	1	4932373165	4002395347940
<p>Polishing sponge soft. Second polish of lacquer, lacquer care</p> <p>⑤</p>	150	50	1	1	4932373186	4002395347964



Spot polisher

Description	Diameter (mm)	Height (mm)	Pack quantity	Min. order quantity	Article Number	EAN Code
<p>Polishing / Sanding backing pad. Thread: M9 x 0.75.</p> <p>① Hook and loop fixation. For use with polishing sponges and abrasive paper</p>	76		1	1	4932430488	4002395381494
<p>Polishing sponge - Hard (yellow). Hard sponge for use with more aggressive polish for removal of deep scratches. Hook and loop fixation. For use with polishing / sanding backing pad</p>	75	25	1	1	4932430489	4002395381500
<p>Polishing sponge - Soft (white). Soft sponge for use with light polish for removal of small scratches. Hook and loop fixation. For use with polishing / sanding backing pad</p>	80	25	1	1	4932430490	4002395381517
<p>Lambswool polishing pad. Hook and loop fixation. For use with polishing / sanding backing pad</p>	80		1	1	4932430838	4002395385003
<p>Fibre disc backing pad. Thread: M9 x 0.75 to affix to tool. Knurled thread to fix coated abrasives and surface finishing products for coarse sanding applications, such as rust removal. Ideal for sanding small or awkward to reach areas such as pinch welds, door shuts and wheel arches</p>	46		1	1	4932430492	4002395381531

①



②



③



④



⑤



Sanders - System attachments

Random orbital sanders

Description	Diameter (mm)	Fits MILWAUKEE® Random Orbital Sanders	Pack quantity	Min. order quantity	Article Number	EAN Code
① Base plate Ø 125 mm, 8 holes. Complete with rubber ring as spare	125	ROS 125 E	2	1	4932430091	4002395377527
① Base plate Ø 150 mm, 6 holes. Complete with rubber ring as spare	150	TXE 150, ROS 150 E	2	1	4932357591	4002395343317
		ROS 150 E-2			4932430145	4002395378067
Clean Line System. Frame with dust bag	125	ROS 125 E	1	1	4931435448	4002395889563
	150	ROS 150	1	1	4931435911	4002395874729
Spare paper bags for 4932345544		TXE 150, TX 125, ROS 150 E	5	1	4931442873	4002395247882
Frame holder for dust bag 4932313096	125/150	ROS 150 E, TXE 150	1	1	4931329719	4002395610938
② Lambswool polishing disc. Finishing high gloss polishing	150	ROS 150, ROS 150 E, TXE 150	1	1	4932373164	4002395347926
③ Lambswool polishing disc. 100% natural lambswool. Premium quality with extremely high fibre density for longer lifetime. Integrated soft touch layer guarantees perfect adjustment to flat and curved profiles. For finishing old and fresh paint. Extremely good polishing of temperature sensitive clear lacquers thanks to heat resistant fibres, e.g. polishing car bumper	135	TX 125, ROS 125 E	1	1	4932430395	4002395380565
④ Polishing sponge hard. Polish up of weather-beaten lacquer, lacquer re-conditioning	150	TXE 150, ROS 150 E, ROS 150	1	1	4932373165	4002395347940
⑤ Polishing sponge hard. Hard sponge with coarse foam structure. For maximum removal of the recondition-ing lacquer, removing deep scratches and polishing weather-beaten lacquer	145	TX 125, ROS 125 E	1	1	4932430396	4002395380572

①



②



③



④



⑤



Orbital sanders

Description	Fits orbital sanders	Pack quantity	Min. order quantity	Article Number	EAN Code
Spare paper bags for 4932345544	VSS 20,VSSE 20, VSS 22,VSSE 22, VS 230,VSS 260, VSSE 260	5	1	4931442873	4002395247882



Delta sanders

Description	Fits delta sanders	Pack quantity	Min. order quantity	Article Number	EAN Code
Dust bag made of sturdy fabric	VS 11 D,FS 2, FS 2 D	1	1	4932351675	4002395320103



Belt sanders

Description	Fits belt sanders	Pack quantity	Min. order quantity	Article Number	EAN Code
Dust bag (spare)	BS 100 S,BS 100 LE	1	1	4932336597	4002395311026
Pair of clamps for Milwaukee® belt sander.		2	1	4932459653	4058546028251



Bandsaws - System attachments

Bandsaw covers

Safety - Protects user from injuries by preventing any access to the blade

Jobsite Armor™ durability - Proprietary composite material and crush zone barriers absorb impacts and protect the tool

Protection from debris - Covers protect the blade track and the pulley wheels from debris entering the tool and affecting overall performance

Tool-free installation and removal within second

Extends life of blade by protecting it from external objects



Description	Pack quantity	Min. order quantity	Article Number	EAN Code
① Bandsaw Cover for HD18 BS	1	1	4932471458	4058546290863
② Bandsaw Cover for M18 FBS85	1	1	4932472241	4058546326371
③ Bandsaw Cover for M18 CBS125 & BS 125	1	1	4932471459	4058546290870

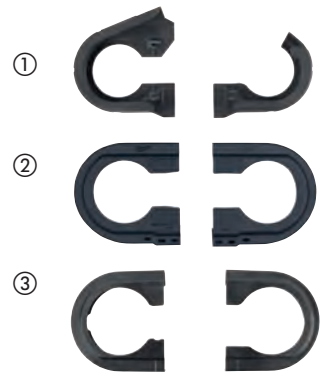

Circular saws - System attachments

Description	Fits Milwaukee Circular Saws	Pack quantity	Min. order quantity	Article Number	EAN Code
Dust absorption connector.	PCS 55	1	1	4932369282	4002395338412
Spanner for removing saw blade.	CS 55, HK 46 N, SCS 65 Q, CS 75, PCS 55, HKS 75, HK 75 A, HKS 85, PMS 18	1	1	4932371469	4002395342181
Parallel guide / fence	SCS 65 Q	1	1	49224146	045242181896
Plastic transport case	SCS 65 Q	1	1	201672001	4002395840519
① Dust extraction hood for MS216 mitre saw		1	1	4932430005	4002395376667
Guide rail clamps		2	1	4932479068	4058546368623
Guide rail joining bars		1	1	4932479069	4058546368630
Replacement guide rail splinter strip		1	1	4932479070	4058546368647
Guide rail bag		1	1	4932479071	4058546368654
Replacement low friction strip		1	1	4932479072	4058546368661
800 mm guide rail		1	1	4932479065	4058546368593
1.4 m aluminium guide rail		1	1	4932479066	4058546368609
2.7 m guide rail		1	1	4932479067	4058546368616



Biscuit jointers - System attachments

Description	Fits biscuit jointers	Pack quantity	Min. order quantity	Article Number	EAN Code
Cutter	LF 650 PJ 710	1	1	4932361072	4002395326679
Frame holder for dust bag 4931443872	LF 650 PJ 710	1	1	4931442872	4002395247899
Spare paper bags for 4932345544	LF 650 PJ 710	5	1	4931442873	4002395247882
Two hole spanner.	LF 650 PJ 710	1	1	4932345712	4002395305551



Planers - System attachments

Description	All planers 82 & 102mm	Pack quantity	Min. order quantity	Article Number	EAN Code
Parallel guide	✓	1	1	4932274071*	4002395300358
Folding rebate depth gauge. For all planers except H500 / PR 1.6-82 models	✓	1	1	4932274069	4002395300129

Planer blades

Description	Width (mm)	Fits planers	Pack quantity	Min. order quantity	Article Number	EAN Code
Tungsten carbide reversible blades. Two reversible blades, suitable for soft and hardwoods	82 mm	M18 BP, H 500, H 750	2	1	4932273484	4002395300150
	102 mm	HB 750, HBE 800	2	1	4932316243	4002395300167



Router bit sets

Description	Pack quantity	Min. order quantity	Article Number	EAN Code
12 pcs router bit set - 8 mm shank	12	1	4932451668	4002395275564



Outdoor products - System attachments

Chainsaws

Description	kerf [mm]	Drive Links	Pitch [mm]	Pack quantity	Min. order quantity	Article Number	EAN Code
16" / 406.4 mm saw chain	1.1	56	9.5 (3/8")	1	1	4932464873	4058546228187
12" / 304.8 mm saw chain	1.1	45	9.5 (3/8")	1	1	4932471385	4058546290139
10" / 254 mm saw chain	1.1	40	9.5 (3/8")	1	1	4932471329	4058546289577
6" / 152 mm saw chain	1.1	28	9.5 (3/8")	1	1	4932478427	4058546346188



Line trimmers

Description	Pack quantity	Min. order quantity	Article Number	EAN Code
2 mm x 45 m trimmer line	1	12	49162712	045242493906
2.4 mm x 76 m trimmer line	1	10	49162713	045242493913
Auto feed trimmer replacement spool (includes 49162712 line)	1	1	49162714	045242006458



Edger

Replacement edger blade to fit M18 FOPH-EA edger attachment.
20.3 cm / 203mm blade length.

Description	Length (mm)	Pack quantity	Min. order quantity	Article Number	EAN Code
Edger blade - 1pc	203	1	1	4932471330	4058546289584



Mower blades

Replacement mower blade to fit M18 F2LM53

Description	Pack quantity	Min. order quantity	Article Number	EAN Code
① Mower blade 21" / 53 cm	1	1	4932479818	4058546376123
② High performance mower blade 21" / 53 cm	1	1	4932479819	4058546376130



Lawn mower covers

To fit M18 F2LM53

Description	Pack quantity	Min. order quantity	Article Number	EAN Code
Lawn mower cover 21" / 53 cm	1	1	4932479821	4058546376154



Crimpers - System attachments

Crimping dies for M18[™] FORCE LOGIC[™] HCCT

Type	Form	Cable lug size (mm ²)	Imprint code	Description	Pack quantity	Min. order quantity	Article Number	EAN Code
① NF C 20-130 for copper compression cable lugs	Hex	16	16	NF22 Cu 16	1	1	4932451733	4002395276837
		25	25	NF22 Cu 25	1	1	4932451734	4002395276844
		35	35	NF22 Cu 35	1	1	4932451735	4002395276851
		50	50	NF22 Cu 50	1	1	4932451736	4002395276868
		70	70	NF22 Cu 70	1	1	4932451737	4002395276875
		95	95	NF22 Cu 95	1	1	4932451738	4002395276882
		120	120	NF22 Cu 120	1	1	4932451739	4002395276899
		150	150	NF22 Cu 150	1	1	4932451740	4002395277506
		185	185	NF22 Cu 185	1	1	4932451741	4002395277513
		240	240	NF22 Cu 240	1	1	4932451742	4002395277520
		300	300	NF22 Cu 300	1	1	4932451743	4002395277544
		② DIN 46235 for copper compression cable lugs and connectors (DIN 46267)	Hex	6	5	DN22 Cu 6	1	1
10	6			DN22 Cu 10	1	1	4932464862	4058546228071
16	8			DIN22 Cu 16	1	1	4932451744	4002395277551
25	10			DIN22 Cu 25	1	1	4932451745	4002395277568
35	12			DIN22 Cu 35	1	1	4932451746	4002395277575
50	14			DIN22 Cu 50	1	1	4932451747	4002395277582
70	16			DIN22 Cu 70	1	1	4932451748	4002395277599
95	18			DIN22 Cu 95	1	1	4932451749	4002395278206
120	20			DIN22 Cu 120	1	1	4932451750	4002395278213
150	22			DIN22 Cu 150	1	1	4932451751	4002395278220
185	25			DIN22 Cu 185	1	1	4932451752	4002395278237
240	28			DIN22 Cu 240	1	1	4932451753	4002395278244
300	32	DIN22 Cu 300	1	1	4932451754	4002395278251		

①

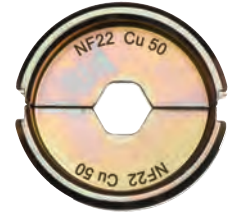

②

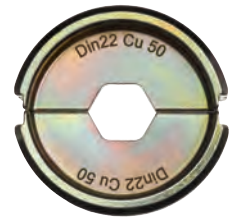

Crimping dies for M18™ FORCE LOGIC™ HCCT

Type	Form	Cable lug size (mm ²)	Imprint code	Description	Pack quantity	Min. order quantity	Article Number	EAN Code
③ Tubular cable lugs and connectors	Hex	16	16	R22 Cu 16	1	1	4932451755	4002395278268
		25	25	R22 Cu 25	1	1	4932451756	4002395278275
		35	35	R22 Cu 35	1	1	4932451757	4002395278282
		50	50	R22 Cu 50	1	1	4932451758	4002395278299
		70	70	R22 Cu 70	1	1	4932451759	4002395278909
		95	95	R22 Cu 95	1	1	4932451760	4002395278916
		120	120	R22 Cu 120	1	1	4932451761	4002395278923
		150	150	R22 Cu 150	1	1	4932451762	4002395278930
		185	185	R22 Cu 185	1	1	4932451763	4002395278947
		240	240	R22 Cu 240	1	1	4932451764	4002395278954
④ Copper solderless terminals (DIN 46234, DIN 46230, DIN 46341)	Half round indent	16	16	Q22 CU 16	1	1	4932451766	4002395278978
		25	25	Q22 CU 25	1	1	4932451767	4002395278985
		35	35	Q22 CU 35	1	1	4932451768	4002395278992
		50	50	Q22 CU 50	1	1	4932451769	4002395279609
⑤ DIN Aluminium for aluminium compression cable lugs and connectors (DIN 46329, 46267 Part 1 and 2, DIN EN 50182)	Hex	16/25	12	DIN22 AL 16/25	1	1	4932451771	4002395279623
		35	14	DIN22 AL 35	1	1	4932451772	4002395279630
		50	16	DIN22 AL 50	1	1	4932451773	4002395279647
		70	18	DIN22 AL 70	1	1	4932451774	4002395279654
		95/120	22	DIN22 AL 95/120	1	1	4932451775	4002395279661
		150	25	DIN22 AL 150	1	1	4932451776	4002395279678
		185	28	DIN22 AL 185	1	1	4932451777	4002395279685
⑥ Copper tubular cable lugs and connectors like L series	Hex	240	32	DIN22 AL 240	1	1	4932451778	4002395279692
		300	34	DIN22 AL 300	1	1	4932451779	4002395279695
		16	8	L22 Cu 16	1	1	4932464487	4058546224325
		25	10	L22 Cu 25	1	1	4932464488	4058546224332
		35	12	L22 Cu 35	1	1	4932464489	4058546224349
		50	14	L22 Cu 50	1	1	4932464490	4058546224356
		70	16	L22 Cu 70	1	1	4932464491	4058546224363
		95	18	L22 Cu 95	1	1	4932464492	4058546224370
		120	20	L22 Cu 120	1	1	4932464493	4058546224387
		150	22	L22 Cu 150	1	1	4932464494	4058546224394
⑦ Pre rounding of triangular shaped aluminium and copper conductors	Round	185	25	L22 Cu 185	1	1	4932464495	4058546224400
		240	28	L22 Cu 240	1	1	4932464496	4058546224417
		16	-	RU22 Cu/Al 16	1	1	4932451780	4002395276912
		35/25	-	RU22 Cu35/AL25	1	1	4932451781	4002395276929
		50/35	-	RU22 Cu50/AL35	1	1	4932451782	4002395276936
⑧ C taps	Oval	70/50	-	RU22 Cu70/AL50	1	1	4932451783	4002395276943
		95/70	-	RU22 Cu95/AL70	1	1	4932451784	4002395276950
		120/95	-	RU22 Cu120/AL95	1	1	4932451785	4002395276967
		150/120	-	RU22 Cu150/AL120	1	1	4932451786	4002395276974
		185/150	-	RU22 Cu185/AL150	1	1	4932451787	4002395276981
⑨ Crimping die box		240/185	-	RU22 Cu240/AL185	1	1	4932451788	4002395276998
		300/240	-	RU22 Cu300/AL240	1	1	4932451789	4002395277605
⑧ C taps	Oval	10	-	C22 Cu 10/C4	1	1	4932464863	4058546228088
		16	-	C22 Cu 16/C5	1	1	4932464864	4058546228095
		25	-	C22 Cu 25/C6	1	1	4932464865	4058546228101
		35	-	C22 Cu 50/C8C9	1	1	4932464866	4058546228118

③

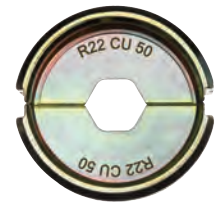

④

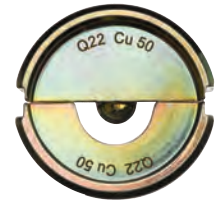

⑤



⑥

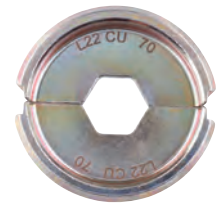

⑦



⑧



⑨



Crimping dies for M18[™] FORCE LOGIC[™] HCCT 109/42

Type	Form	Cable lug size (mm ²)	Imprint code	Description	Pack quantity	Min. order quantity	Article Number	EAN Code
① DIN Aluminium for aluminium compression cable lugs and connectors (DIN 46329, 46267 Part 1 und 2, DIN EN 50182)	Hex	16/25	12	DIN13 AL 16/25	1	1	4932459506	4058546026783
		35	14	DIN13 AL 35	1	1	4932459507	4058546026790
		50	16	DIN13 AL 50	1	1	4932459508	4058546026806
		70	18	DIN13 AL 70	1	1	4932459509	4058546026813
		95/120	22	DIN13 AL 95/120	1	1	4932459510	4058546026820
		150	25	DIN13 AL 150	1	1	4932459511	4058546026837
		185	28	DIN13 AL 185	1	1	4932459512	4058546026844
		240	32	DIN13 AL 240	1	1	4932459513	4058546026851
		300	34	DIN13 AL 300	1	1	4932459514	4058546026868
		② Copper tubular cable lugs and connectors like L series	Hex	16	8	L13 Cu 16	1	1
25	10			L13 Cu 25	1	1	4932464501	4058546224462
35	12			L13 Cu 35	1	1	4932464502	4058546224479
50	14			L13 Cu 50	1	1	4932464503	4058546224486
70	16			L13 Cu 70	1	1	4932464504	4058546224493
95	18			L13 Cu 95	1	1	4932464505	4058546224509
120	20			L13 Cu 120	1	1	4932464506	4058546224516
150	22			L13 Cu 150	1	1	4932464507	4058546224523
185	25			L13 Cu 185	1	1	4932464508	4058546224530
240	28			L13 Cu 240	1	1	4932464509	4058546224547
③ Pre rounding of triangular shaped aluminium and copper conductors	Round	16	-	RU13 Cu/Al16	1	1	4932459483	4058546011444
		35/25	-	RU13 Cu35/AL25	1	1	4932459484	4058546011451
		50/35	-	RU13 Cu50/AL35	1	1	4932459485	4058546011468
		70/50	-	RU13 Cu70/AL50	1	1	4932459486	4058546011475
		95/70	-	RU13 Cu95/AL70	1	1	4932459487	4058546011482
		120/95	-	RU13 Cu120/AL95	1	1	4932459488	4058546011499
		150/120	-	RU13 Cu150/AL120	1	1	4932459489	4058546011505
		185/150	-	RU13 Cu185/AL150	1	1	4932459490	4058546011512
		240/185	-	RU13 Cu240/AL185	1	1	4932459491	4058546011529
		300/240	-	RU13 Cu300/AL240	1	1	4932459492	4058546011536
④ Ferruls	Trapezoid	16	-	AEH13 Cu 16	1	1	4932459515	4058546026875
		25	-	AEH13 Cu 25	1	1	4932459516	4058546026882
		35	-	AEH13 Cu 35	1	1	4932459517	4058546026899
		50	-	AEH13 Cu 50	1	1	4932459518	4058546026905
		70	-	AEH13 Cu 70	1	1	4932459519	4058546026912
		95	-	AEH13 Cu 95	1	1	4932459520	4058546026929
		120	-	AEH13 Cu 120	1	1	4932459521	4058546026936
		150	-	AEH13 Cu 150	1	1	4932459522	4058546026943
		185	-	AEH13 Cu 185	1	1	4932459523	4058546026950
		240	-	AEH13 Cu 240	1	1	4932459524	4058546026967
⑤ C taps	Oval	16	-	C13 Cu 16	1	1	4932459525	4058546026974
		25	-	C13 Cu 25	1	1	4932459526	4058546026981
		35	-	C13 Cu 35	1	1	4932459527	4058546026998
		50	-	C13 Cu 50	1	1	4932459528	4058546027001
		70	-	C13 Cu 70	1	1	4932459529	4058546027018
		10	-	C13 Cu 10	1	1	4932459530	4058546027025
		10-35	-	C13 Cu 10-35	1	1	4932459531	4058546027032
		25-50	-	C13 Cu 25-50	1	1	4932459532	4058546027049
		35-70	-	C13 Cu 35-70	1	1	4932459533	4058546027056
		70	-	HAH13 Cu 70	1	1	4932459534	4058546027063
⑥ H clamps	Oval	95	-	HAH13 Cu 95	1	1	4932459535	4058546027070
		120	-	HAH13 Cu 120	1	1	4932459536	4058546027087
⑦ Double press cable shoes	Oval	2x50	-	DP13 Cu 2x50	1	1	4932459537	4058546027094
		2x70	-	DP13 Cu 2x70	1	1	4932459538	4058546027100
		2x95	-	DP13 Cu 2x95	1	1	4932459539	4058546027117
⑧ Crimping die box for M18 HCCT109/42 crimping (dies to be bought separately)					1	1	4932464211	4058546221560

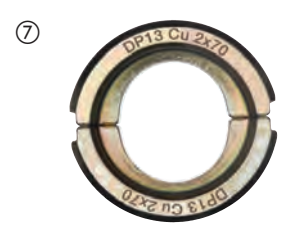
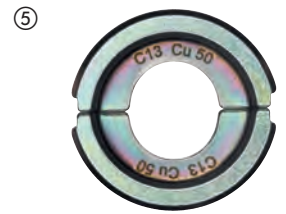
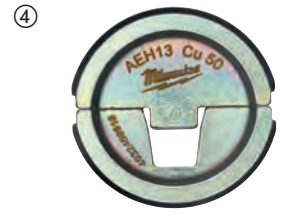
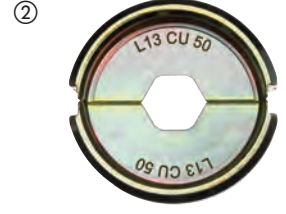
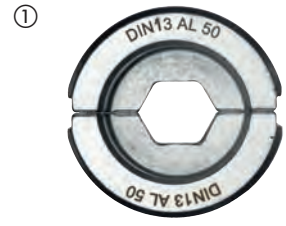

Crimping dies for M18™ HCCT 109/42

Type	Form	Cable lug size (mm ²)	Imprint code	Description	Pack quantity	Min. order quantity	Article Number	EAN Code
① NF C 20-130 for copper compression cable lugs	Hex	16	16	NF13 Cu 16	1	1	4932459453	4058546011147
		25	25	NF13 Cu 25	1	1	4932459454	4058546011154
		35	35	NF13 Cu 35	1	1	4932459455	4058546011161
		50	50	NF13 Cu 50	1	1	4932459456	4058546011178
		70	70	NF13 Cu 70	1	1	4932459457	4058546011185
		95	95	NF13 Cu 95	1	1	4932459458	4058546011192
		120	120	NF13 Cu 120	1	1	4932459459	4058546011208
		150	150	NF13 Cu 150	1	1	4932459460	4058546011215
		185	185	NF13 Cu 185	1	1	4932459461	4058546011222
		240	240	NF13 Cu 240	1	1	4932459462	4058546011239
② DIN 46235 for copper compression cable lugs and connectors (DIN 46267)	Hex	16	8	DIN13 Cu 16	1	1	4932459465	4058546011260
		25	10	DIN13 Cu 25	1	1	4932459466	4058546011277
		35	12	DIN13 Cu 35	1	1	4932459467	4058546011284
		50	14	DIN13 Cu 50	1	1	4932459468	4058546011291
		70	16	DIN13 Cu 70	1	1	4932459469	4058546011307
		95	18	DIN13 Cu 95	1	1	4932459470	4058546011314
		120	20	DIN13 Cu 120	1	1	4932459471	4058546011321
		150	22	DIN13 Cu 150	1	1	4932459472	4058546011338
		185	25	DIN13 Cu 185	1	1	4932459473	4058546011345
		240	28	DIN13 Cu 240	1	1	4932459474	4058546011352
③ Tubular cable lugs and connectors	Hex	16	16	R13 Cu 16	1	1	4932459494	4058546011550
		25	25	R13 Cu 25	1	1	4932459495	4058546011567
		35	35	R13 Cu 35	1	1	4932459496	4058546011574
		50	50	R13 Cu 50	1	1	4932459497	4058546011581
		70	70	R13 Cu 70	1	1	4932459498	4058546011598
		95	95	R13 Cu 95	1	1	4932459499	4058546011604
		120	120	R13 Cu 120	1	1	4932459500	4058546011611
		150	150	R13 Cu 150	1	1	4932459501	4058546011628
		185	185	R13 Cu 185	1	1	4932459502	4058546011635
		240	240	R13 Cu 240	1	1	4932459503	4058546011642
④ Copper solderless terminals (DIN 46234, DIN 46230, DIN 46341)	Half round indent	16	16	Q13 CU 16	1	1	4932459477	4058546011383
		25	25	Q13 CU 25	1	1	4932459478	4058546011390
		35	35	Q13 CU 35	1	1	4932459479	4058546011406
		50	50	Q13 CU 50	1	1	4932459480	4058546011413
		70	70	Q13 CU 70	1	1	4932459481	4058546011420
		95	95	Q13 CU 95	1	1	4932459482	4058546011437

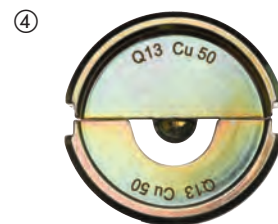
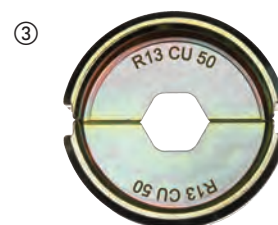
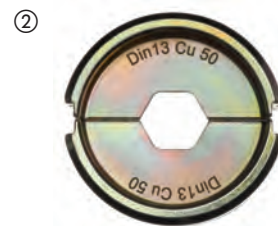
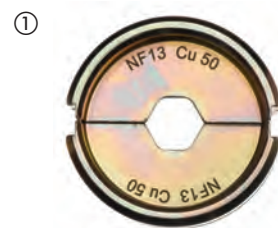

Crimp die kits

Description	Pack quantity	Min. order quantity	Article Number	EAN Code
DIN22 Cu die kit for M18 HCCT				
① Die storage box incl. 11 dies - 16, 25, 35, 50, 70, 95, 120, 150, 185, 240 & 300 mm ²	11	1	4932471997	4058546298968
DIN22 Al die kit for M18 HCCT				
② Die storage box incl. 9 dies - 16/25, 35, 50, 70, 95/120, 150, 185, 240 & 300 mm ²	9	1	4932471998	4058546298975
R22 Cu die kit for M18 HCCT				
③ Die storage box incl. 11 dies - 16, 25, 35, 50, 70, 95, 120, 150, 185, 240 & 300 mm ²	11	1	4932471999	4058546298982
DIN13 Cu die set for M18 HCCT109/42				
④ Die storage box incl. 11 dies - 16, 25, 35, 50, 70, 95, 120, 150, 185, 240 & 300 mm ²	11	1	4932472000	4058546323967
DIN13 Al die set for M18 HCCT109/42				
⑤ Die storage box incl. 9 dies - 16/25, 35, 50, 70, 95/120, 150, 185, 240 & 300 mm ²	9	1	4932472001	4058546323974
R13 Cu die set for M18 HCCT109/42				
⑥ Die storage box incl. 11 dies - 16, 25, 35, 50, 70, 95, 120, 150, 185, 240 & 300 mm ²	11	1	4932472002	4058546323981

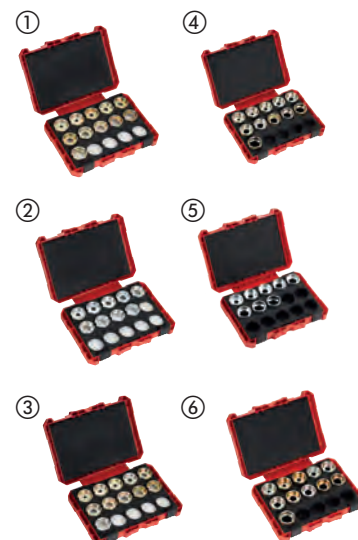

Pipe cutter / Cable cutter blades for M12[™]

Description	Pack quantity	Min. order quantity	Article Number	EAN Code
① Pipe cutter wheels. Suitable for copper pipe. Not suitable for plastic or stainless steel pipe	2	1	48380010	045242159710
② Cable cutter blade	1	1	4932430070	4002395377312
PEX cutter blade for C12 PPC	1	1	4931441978	4002395179268
Wheels for M12 [™] RAPTOR [™] pipe cutter stainless steel - 2pc	2	1	4932479243	4058546370374



Cable cutters - System attachments

Cable Cutter Blades suitable for M18[™] HCCAC / M18[™] HCCS

Description	Pack quantity	Min. order quantity	Article Number	EAN Code
① ACSR Aluminium steel reinforced cable cutting jaw including blades	1	1	49162773	045242350070
② ACSR Aluminium steel reinforced cable cutting blades	1	1	48440412	045242355235
① Cu/Al standard copper & aluminium cable cutting jaw including blades	1	1	4932430839	4002395385010
② Replacement cable cutter blades for copper and aluminium.	1	1	4932464498	4058546224431
① Armored cable cutting Jaw for M18 HCC	1	1	4932464867	4058546228125
② Replacement SWA blade for M18 HCC	1	1	4932464868	4058546228132
① FSW fine stranded wire cutting jaw including blades	1	1	49162778	045242505722
② FSW fine stranded wire cutting blades	1	1	48442778	045242505739
① EHS guy wire/steel wire cutting jaw including blades	1	1	49162777	045242505449
② EHS guy wire/steel wire cutting blades	1	1	48442777	045242505456



Cable cutting blades suitable for M18 HCCT

Description	Pack quantity	Min. order quantity	Article Number	EAN Code
Cu/Al standard Copper & Aluminium cable cutting jaw	1	1	4932464497	4058546224424



Cable cutter blades for underground cutter M18™ FORCE LOGIC™ HCC75

Description	Pack quantity	Min. order quantity	Article Number	EAN Code
Underground cutter blade M18 HCC75	1	1	49162774	045242486663



Cable cutter blades for M18™ FORCE LOGIC™ HCC45

Description	Pack quantity	Min. order quantity	Article Number	EAN Code
ACSR blade M18 HCC45	1	1	49162775	045242486632



Dies for M18™ BLTRC threaded rod cutter

Description	Pack quantity	Min. order quantity	Article Number	EAN Code
Dies for M18™ BLTRC threaded rod cutter	2	1	4932471372	4058546290009



M18 FUEL™ fish tapes - System attachments

Steel fish drums

Description	Pack quantity	Min. order quantity	Article Number	EAN Code
36 m x 3 mm steel fish drum	1	1	48445176	4058546326432
72 m x 3 mm steel fish drum	1	1	48445178	4058546326449



Non-conductive drums

Description	Pack quantity	Min. order quantity	Article Number	EAN Code
30 m non-conductive polyester drum	1	1	48445195	4058546326463
60 m non-conductive polyester drum	1	1	48445197	4058546326470



Knockout punch - System attachments

Knockout punch and dies

Suitable for mild steel and aluminium up to a thickness of 3 mm.
Also suitable for stainless steel max. 2.5 mm.



Diameter (mm)	Standard PG size	Standard ISO metric size	Pack quantity	Min. order quantity	Punch		Die	
					Article Number	EAN Code	Article Number	EAN Code
16.2		M 16	1	1	4932430841	4002395385034	4932430913	4002395385751
20.4	PG 13.5	M 20	1	1	4932430842	4002395385041	4932430914	4002395385768
22.5	PG 16 1/2"		1	1	4932430843	4002395385058	4932430915	4002395385775
25.4		M 25	1	1	4932430844	4002395385065	4932430916	4002395385782
28.3	PG 21 1/2"		1	1	4932430845	4002395385072	4932430917	4002395385799
32.5		M 32	1	1	4932430846	4002395385089	4932430918	4002395385805
40.5		M 40	1	1	4932430847	4002395385096	4932430919	4002395385812
50.5		M 50	1	1	4932430848	4002395385102	4932430920	4002395385829
63.5		M 63	1	1	4932430849	4002395385119	4932430921	4002395385836

Draw stud bolt 49162680 (for 16.2 and 20.4 mm) Ø 11,1 mm: requires pre-drilling with Ø 11.3 - 11.5 mm drill bit / step drill.
Draw stud bolt 49162681 Ø 19 mm: requires pre-drilling with Ø 19.5 - 20 mm drill bit / step drill.

Description	Pack quantity	Min. order quantity	Article Number	EAN Code
Adaptor to allow the Milwaukee® tool to use competitors punches and dies ie. Klauke®, Greenlee® and Alfra®	1	1	49162685	045242337965

Hydraulic pump - System attachments

1.8 meter controller extension cord

Compatible with M18™ FORCE LOGIC™ hydraulic pump
IP 67 ingress protection for reliable use in the elements
Male-female connectors for interconnectable extension up to 7.3 m of length

Description	Pack quantity	Min. order quantity	Article Number	EAN Code
1.8 meter controller extension cord	1	1	49122775	4058546326487



Hydraulic oil

1 Liter accessory oil for M18™ FORCE LOGIC™ HUP700 hydraulic pump
Ensures full performance and reliable use in extreme environmental conditions from -18°C to 50°C

Description	Pack quantity	Min. order quantity	Article Number	EAN Code
Replacement oil M18 HUP700	1	1	4932472004	4058546324001



Bucket hanger

Compatible with M18™ FORCE LOGIC™ hydraulic pump
Extendable bar & rubber bumpers allow for use with most existing buckets & steel baskets
Symmetrical lift ring design enable use from both sides of the hanger
Keeps pump in ideal, level operating position while freeing up space inside the bucket
Standard size lift rings allow for use with existing bucket hooks
Open frame design enables the user to open the pump battery door while still resting in the hanger

Description	Pack quantity	Min. order quantity	Article Number	EAN Code
Bucket hanger for M18 HUP700	1	1	49122776	045242535231



Expansion tools - System attachments







Expander heads

Description	Pipe diameter (mm)	Pipe wall thickness (mm)	Pipe pressure (bar)	Suitable	Pack quantity	Min. order quantity	Article Number	EAN Code
PXPH9-144/8	9.9	1.1	4/8	M12, M18	1	1	4932430102	4002395377633
PXPH12I-14	12	1.7/ 1.8/ 2	6-10	M12, M18	1	1	4932352716	4002395373741
PXPH15N-14	14 / 15	2.5	6-10	M12, M18	1	1	4932352727	4002395373857
PXPH16I-1406	16	1.5/ 1.8	6	M12, M18	1	1	4932430103	4002395377640
PXPH16I-1410	16	1.8/ 2.0/ 2.2	10	M12, M18	1	1	4932352717	4002395373758
PXPH18N-14	17 / 18	2.5	6-10	M12, M18	1	1	4932352728	4002395373864
PXPH20I-1406	20	1.9/ 2.0/ 2.3	6, (8 bar - Ø 2.3 mm)	M12, M18	1	1	4932352718	4002395373765
PXPH20I-1410	20	2.8	10	M12, M18	1	1	4932352719	4002395373772
PXPH20I-2506	20	1.9/ 2.0/ 2.3	6, (8 bar - Ø 2.3 mm)	M18	1	1	4932352733	4002395373918
PXPH20I-2510	20	2.8	10	M18	1	1	4932352748	4002395374069
PXPH22N-14	22	3	6-10	M12, M18	1	1	4932352729	4002395373871
PXPH25I-1406	25	2.3	6	M12, M18	1	1	4932352720	4002395373789
PXPH25I-1410	25	3.5	10	M12, M18	1	1	4932352721	4002395373796
PXPH25I-2506	25	2.3	6	M18	1	1	4932352722	4002395373802
PXPH25I-2510	25	3.5	10	M18	1	1	4932352749	4002395374076
PXPH28N-14	28	4	6-10	M12, M18	1	1	4932352730	4002395373888
PXPH32I-1406	32	2.9	6	M12, M18	1	1	4932472273	4058546339197
PXPH32I-25	32	2.9/ 4.4	6-10	M18	1	1	4932352724	4002395373826
PXPH40I-2506	40	3.7	6	M18	1	1	4932352725	4002395373833
PXPH 40I - 2510	40	5.5	10	M18 FPXP	1	1	4932479581	4058546373757
PXPH 40I - 5606	40	3.7	6-10	M18 BLPXPL	1	1	4932451396	4002395160884
PXPH 50I - 25	50	4.6/ 6.9	6-10	M18 FPXP	1	1	4932479582	4058546373764
PXPH 50I - 5606	50	4.6	6-10	M18 BLPXPL	1	1	4932451397	4002395160891
PXPH 63I - 5606	63	5.8	6-10	M18 BLPXPL	1	1	4932451398	4002395158102
PXPH 75I - 5606	75	6.8	6-10	M18 BLPXPL	1	1	4932451399	4002395158119
Grease								
Tube contents 50 g. For lubrication of cone and expander heads					1	1	4932352726	4002395373840
Grease Expander Heads 40/50 mm								
Tube contents 150 g. For lubrication of M18 FPXP cone and 40/50 mm expander heads					1	1	4932479835	4058546376291









Press tools - System attachments







Press jaws

Jaw profile	Fits to following pipe systems suppliers	Nominal size	Tool suitability	Jaw model description	Id. No. 4932-	EAN Code					
FF	Geberit FlowFit	16 - 40	M12	J12 16-40mm FlowFit	480981	4058546412661					
		16 - 40	M18	J18 16-40mm FlowFit	480982	4058546412678					
		50 - 75	M18	J18 50-75mm FlowFit	480983	4058546412685					
M	Geberit Mapress	12	M12	J12-M12 Geberit	480879	4058546411640					
		12	M18	J18-M12 Geberit	480885	4058546411701					
		15	M12	J12-M15 Geberit	480880	4058546411657					
		15	M18	J18-M15 Geberit	480886	4058546411718					
		18	M12	J12-M18 Geberit	480881	4058546411664					
		18	M18	J18-M18 Geberit	480887	4058546411725					
		22	M12	J12-M22 Geberit	480882	4058546411671					
		22	M18	J18-M22 Geberit	480888	4058546411732					
		28	M12	J12-M28 Geberit	480883	4058546411688					
		28	M18	J18-M28 Geberit	480889	4058546411749					
		35	M12	J12-M35 Geberit	480884	4058546411695					
35	M18	J18-M35 Geberit	480890	4058546411756							
G	Geberit Mepla	16	M12	J12-G16 Geberit	480891	4058546411763				 Jaw G profile	
		16	M18	J18-G16 Geberit	480896	4058546411817					
		20	M12	J12-G20 Geberit	480892	4058546411770					
		20	M18	J18-G20 Geberit	480897	4058546411824					
		26	M12	J12-G26 Geberit	480893	4058546411787					
		26	M18	J18-G26 Geberit	480898	4058546411831					
		32	M12	J12-G32 Geberit	480894	4058546411794					
		32	M18	J18-G32 Geberit	480899	4058546411848					
		40	M12	J12-G40 Geberit	480895	4058546411800					
		40	M18	J18-G40 Geberit	480900	4058546411855					
		50	M18	J18-G50 Geberit	480901	4058546411862					
		63	M18	RJ18-G63 Geberit (requires ring jaw adaptor RJA - Geberit)	480966	4058546412517					 Ring jaw G profile
		75	M18	RJ18-G75 Geberit (requires ring jaw adaptor RJA - Geberit)	480967	4058546412524					
B	Connex & Bänninger MaxiPro >B< Press	1/4"	M12	J12-B 1/4"	493155	4058546480264					
		1/4"	M18	J18-B 1/4"	493163	4058546480349					
		3/8"	M12	J12-B 3/8"	493156	4058546480271					
		3/8"	M18	J18-B 3/8"	493164	4058546480356					
		1/2"	M12	J12-B 1/2"	493157	4058546480288					
		1/2"	M18	J18-B 1/2"	493165	4058546480363					
		5/8"	M12	J12-B 5/8"	493158	4058546480295					
		5/8"	M18	J18-B 5/8"	493166	4058546480370					
		3/4"	M12	J12-B 3/4"	493159	4058546480301					
		3/4"	M18	J18-B 3/4"	493167	4058546480387					
		7/8"	M12	J12-B 7/8"	493160	4058546480318					
		7/8"	M18	J18-B 7/8"	493168	4058546480394					
		1"	M12	J12-B 1"	493161	4058546480325					
		1"	M18	J18-B 1"	493169	4058546480400					
		1 1/8"	M12	J12-B 1 1/8"	493162	4058546480332					
1 1/8"	M18	J18-B 1 1/8"	493170	4058546480417							
MP	Viega Mega Press	1/2"	M18	J18-MP1/2"	479442	4058546372361				 Jaw MP profile	
		3/4"	M18	J18-MP3/4"	479443	4058546372378					
		1"	M18	J18-MP1"	479444	4058546372385					
		1 1/4"	M18	J18-MP1 1/4" (requires ring jaw adaptor RJA - 1)	479445	4058546372392					
		1 1/2"	M18	J18-MP1 1/2" (requires ring jaw adaptor RJA - 1)	479446	4058546372408					
		2"	M18	J18-MP2" (requires ring jaw adaptor RJA - 1)	479447	4058546372415					
		2 1/2"	M18 XL	RJ18XL-MP2 1/2" (requires ring jaw adaptor RJAXL - 1)	479448	4058546372422					
		3"	M18 XL	RJ18XL-MP3" (requires ring jaw adaptor RJAXL - 1)	479449	4058546372439					
4"	M18 XL	RJ18XL-MP4" (requires ring jaw adaptor RJAXL - 1)	479450	4058546372446				 Ring jaw MP profile			

Press jaws

Jaw profile	Fits to following pipe systems suppliers	Nominal size	Tool suitability	Jaw model description	Id. No. 4932-	EAN Code					
M	Geberit: Mapress VSH: X-Press Eurotubi Raccorderie Metallique Rubinetteria Bresciane Sanha: Niroсан Pegler Yorkshire	M12	M12	J12-M12	430243	4002395379040				 Jaw M profile	
		M12	M18	J18-M12	430244	4002395379057					
		M15	M12	J12-M15	430245	4002395379064					
		M15	M18	J18-M15	430246	4002395379071					
		M18	M12	J12-M18	430247	4002395379088					
		M18	M18	J18-M18	430248	4002395379095					
				M22	M12	J12-M22	430249	4002395379101			 Ring jaw M profile
				M22	M18	J18-M22	430250	4002395379118			
				M28	M12	J12-M28	430251	4002395379125			
				M28	M18	J18-M28	430252	4002395379132			
				M35	M12	J12-M35	430253	4002395379149			
				M35	M18	J18-M35	430254	4002395379156			
				M42	M18	RJ18-M42 (requires ring jaw adaptor RJA-1)	430255	4002395379163			
				M54	M18	RJ18-M54 (requires ring jaw adaptor RJA-1)	430256	4002395379170			
		M76,1	M18 XL	RJ18XL-M76,1 (requires ring jaw adaptor RJAXL - 1)	479458	4058546372521					
		M88,9	M18 XL	RJ18XL-M88,9 (requires ring jaw adaptor RJAXL - 1)	479459	4058546372538					
		M108	M18 XL	RJ18XL-M108 (requires ring jaw adaptor RJAXL - 1 & RJAXL - 2)	479460	4058546372545					
V	Viega Comap IBP Sanha: Niroсан	V12	M12	J12-V12	430260	4002395379217			 Jaw V profile		
		V12	M18	J18-V12	430261	4002395379224					
		V14	M12	J12-V14	451660	4002395273423					
		V14	M18	J18-V14	471086	4058546287146					
		V15	M12	J12-V15	430262	4002395379231					
		V15	M18	J18-V15	430263	4002395379248					
				V16	M12	J12-V16	451661	4002395273430			 Ring jaw V profile
				V16	M18	J18-V16	471087	4058546287153			
				V18	M12	J12-V18	430264	4002395379255			
				V18	M18	J18-V18	430265	4002395379262			
				V22	M12	J12-V22	430266	4002395379279			
				V22	M18	J18-V22	430267	4002395379286			
				V28	M12	J12-V28	430268	4002395379293			
				V28	M18	J18-V28	430269	4002395379309			
				V35	M12	J12-V35	430270	4002395379316			
				V35	M18	J18-V35	430271	4002395379323			
				V42	M18	RJ18-V42 (requires ring jaw adaptor RJA-1)	430272	4002395379330			
				V54	M18	RJ18-V54 (requires ring jaw adaptor RJA-1)	430273	4002395379347			
		V64	M18	RJ18-V64 (requires ring jaw adaptorRJAV-2)	479453	4058546372477					
		V66,7	M18	RJ18-V66,7 (requires ring jaw adaptorRJAV-2)	479454	4058546372484					
		V76,1	M18	RJ18-V76,1 (requires ring jaw adaptorRJAV-2)	479455	4058546372491					
		V88,9	M18	RJ18-V88,9 (requires ring jaw adaptorRJAV-2)	479456	4058546372507					
		V108	M18	RJ18-V108 (requires ring jaw adaptorRJAV-2)	479457	4058546372514					
TH	ALB Comap Fränkische Henco IPA Sanha Tiemme	TH14	M12	J12-TH14	430274	4002395379354			 Jaw TH profile		
		TH14	M18	J18-TH14	430275	4002395379361					
		TH16	M12	J12-TH16	430276	4002395379378					
		TH16	M18	J18-TH16	430277	4002395379385					
		TH18	M12	J12-TH18	430278	4002395379392					
		TH18	M18	J18-TH18	430279	4002395379408					
				TH20	M12	J12-TH20	430280	4002395379415			 Ring jaw TH profile
				TH20	M18	J18-TH20	430281	4002395379422			
				TH25	M12	J12-TH25	430282	4002395379439			
				TH25	M18	J18-TH25	430355	4002395380169			
				TH26	M12	J12-TH26	430283	4002395379446			

Press jaws

Jaw profile	Fits to following pipe systems suppliers	Nominal size	Tool suitability	Jaw model description	Id. No. 4932-	EAN Code			
TH	ALB Comap Fränkische Henco (TH14 - TH25 only) IPA Sanha Tiemme	TH26	M18	J18-TH26	430284	4002395379453			 Jaw TH profile  Ring jaw TH profile
		TH32	M12	J12-TH32	430285	4002395379460			
		TH32	M18	J18-TH32	430286	4002395379477			
		TH40	M12	J12-TH40	430287	4002395379484			
		TH40	M18	RJ18-TH40 (requires ring jaw adaptor RJA-1)	430288	4002395379491			
		TH50	M18	RJ18-TH50 (requires ring jaw adaptor RJA-1)	430289	4002395379507			
		TH63	M18	RJ18-TH63 (requires ring jaw adaptor RJA-1)	430290	4002395379514			
U	ALB Uponor: Unipipe, Airpipe Kann: Kann-therm Wavin: Press-Systeme Fränkische: Alpex F50 Profi DW Verbundrohr: Multitubo IBP: >B< Flex KE Kelit: Kelit Kelox Jupiter: Heizsystem	U14	M12	J12-U14	430291	4002395379521		 Jaw U profile  Ring jaw U profile	
		U14	M18	J18-U14	430292	4002395379538			
		U16	M12	J12-U16	430293	4002395379545			
		U16	M18	J18-U16	430294	4002395379552			
		U18	M12	J12-U18	430295	4002395379569			
		U18	M18	J18-U18	430296	4002395379576			
		U20	M12	J12-U20	430297	4002395379583			
		U20	M18	J18-U20	430298	4002395379590			
		U25	M12	J12-U25	430299	4002395379606			
		U25	M18	J18-U25	430300	4002395379613			
		U32	M12	J12-U32	430301	4002395379620			
		U32	M18	J18-U32	430302	4002395379637			
		U40	M12	J12-U40	430303	4002395379644			
		U40	M18	RJ18-U40 (requires ring jaw adaptor RJA-1)	430304	4002395379651			
U50	M18	RJ18-U50 (requires ring jaw adaptor RJA-1)	430305	4002395379668					
U63	M18	RJ18-U63 (requires ring jaw adaptor RJA-1)	430306	4002395379675					
ACz	ACOME MT	Acz12	M12	J12-ACz 12	459388	4058546010492		 Jaw ACz profile	
		Acz16	M12	J12-ACz 16	459389	4058546010508			
		Acz20	M12	J12-ACz 20	459390	4058546010515			
		Acz25	M12	J12-ACz 25	459391	4058546010522			
G	Geberit: Mepla & Mepla Therm	G16	M12	J12-G16	464217	4058546221621		 Jaw G profile	
		G16	M18	J18-G16	464544	4058546224899			
		G20	M12	J12-G20	464218	4058546221638			
		G20	M18	J18-G20	464545	4058546224905			
		G26	M12	J12-G26	464219	4058546221645			
		G26	M18	J18-G26	464546	4058546224912			
		G32	M12	J12-G32	464220	4058546221652			
		G32	M18	J18-G32	464547	4058546224929			
		G40	M12	J12-G40	464221	4058546221669			
		G40	M18	J18-G40	464548	4058546224936			
G50	M18	J18-G50	464549	4058546224943					
① Ring jaw adaptor				RJA-1	430307	4002395379682		 Ring jaw adaptor	
			M18	RJAV-2	479604	4058546373986			
			M18	RJA - Geberit	480968	4058546412531			
			M18 XL	RJAXL-1	479451	4058546372453			
			M18 XL	RJAXL-2	479452	4058546372460			

Drum machine attachments

Description	Fits drain cleaners M12B-DC6, M12 BDC8	Fits drain cleaners M18 FDCPF8, M18 FDCPF10	Fits drain cleaners M18 FFSDC16, M18 FFSDC13, M18 FFS-DC10	Fits drain cleaners MXF LSDP	Article Number	EAN Code
① 16 mm x 15.2 m open wind coupling end			✓		48532775	045242513109
6 mm x 7.6 m inner core bulb head	✓				48532573	045242471270
8 mm x 7.6 m inner core drop head	✓				48532572	045242364206
6 mm x 7.6 m inner core drop head	✓				48532574	045242471287
6 mm x 10.6 m inner core bulb head		✓			48532671	045242482740
6 mm x 15.2 m inner core bulb head		✓			48532672	045242482757
8 mm x 7.6 m inner core bulb head	✓				48532571	045242364213
② 8 mm x 10.6 m inner core bulb head		✓			48532673	045242482764
8 mm x 15.2 m inner core bulb head					48532674	045242482771
10 mm x 10.6 m inner core coupling end		✓			48532675	045242482788
6 mm x 7.6 m inner core bulb head drum	✓				48532581	045242480586
6 mm x 7.6 m inner core drop head drum	✓				48532582	045242480593
8 mm x 7.6 m inner core bulb head drum	✓				48532583	045242480609
8 mm x 7.6 m inner core drop head drum	✓				48532584	045242480616
8 mm x 23 m inner core bulb head			✓		48532772	045242513079
10 mm x 15.2 m inner core coupling end			✓		48532773	045242513086
13 mm x 15.2 m inner core coupling end			✓		48532774	045242513093
16 mm x 7.6 m inner core coupling end				✓	4932471701	4058546296001
16 mm x 15.2 m inner core coupling end				✓	4932471702	4058546296018
③ 20 mm x 7.6 m inner core coupling end				✓	4932471703	4058546296025
20 mm x 15.2 m inner core coupling end				✓	4932471704	4058546296032
16 mm anchor cable coupling end				✓	4932471707	4058546296063
16 mm x 60 cm leader cable coupling end				✓	4932471708	4058546296070
20 mm x 600 mm leader cable coupling end				✓	4932471709	4058546296087
④ Small bulb auger for 10, 13, 16 mm cables		✓	✓		48532681	045242503803
Small C cutter for 10, 13, 16 mm cables		✓	✓		48532684	045242503834
⑤ Medium C cutter for 10, 13, 16 mm cables					48532789	045242006137
75 mm chain knocker for 16, 20 mm cables				✓	48532837	4058546323448
⑥ 100 mm chain knocker for 16, 20 mm cables				✓	48532838	4058546323455
Small drop head for 10, 13, 16 mm cables		✓	✓		48532682	045242503810
⑦ Medium drop head for 10, 13, 16 mm cables		✓	✓		48532787	045242006113
Funnel auger for 16, 20 mm cables				✓	48532831	4058546323387
⑧ Medium funnel auger for 10, 13, 16 mm cables		✓	✓		48532786	045242006106
Small 5 pc head kit for 10, 13, 16 mm cables		✓	✓		48532685	045242503841
⑨ Medium 5 pc head kit for 10, 13, 16 mm cables		✓	✓		48532790	045242006144
9 pc head kit 16, 20 mm cables				✓	48532840	4058546296131
⑩ Small opening tool for 16, 20 mm cables				✓	48532835	4058546323424
Medium opening tool for 16, 20 mm cables				✓	48532836	4058546323431
75 mm root cutter for 16, 20 mm cables				✓	48532832	4058546323394
⑪ 100 mm root cutter for 16, 20 mm cables				✓	48532833	4058546323400
150 mm root cutter for 16, 20 mm cables				✓	48532834	4058546323417
Small spade bit for 10, 13, 16 mm cables		✓	✓		48532683	045242503827
⑫ Medium spade bit for 10, 13, 16 mm cables		✓	✓		48532788	045242006120
⑬ Straight auger for 16, 20 mm cables				✓	48532830	4058546323370
⑭ SWITCH PACK™ auto feed for M18 FFSDC series			✓		4932471993	4058546298920
⑮ Guide hose for SWITCH PACK™ auto feed			✓		4932471994	4058546298937
⑯ Base plate for SWITCH PACK™ auto feed			✓		4932478225	4058546344023
⑰ SWITCH PACK™ drum for M18 FFSDC series			✓		4932464277	4058546222222
⑱ Guide hose for MXFLSDP				✓	4932478110	4058546340421
Pin key for all cables		✓	✓	✓	4932471717	4058546296162



Sectional sewer machine attachments

Description	Fits sewer machine		Article Number	EAN Code
	M18 FCSSM	M18 FSSM		
16 mm x 2.3 m open wind coupling end	✓		4932478413	4058546346041
16 mm x 2.3 m open wind inner core coupling	✓		4932478414	4058546346058
22 mm x 4.5 m open wind inner core coupling end	✓	✓	4932478415	4058546346065
① 22 mm x 4.5 m open wind coupling end	✓	✓	4932471712	4058546296117
22 mm x 4.5 m open wind coupling end kit	✓	✓	4932471713	4058546296124
32 mm x 4.5 m open wind coupling end		✓	4932471710	4058546296094
32 mm x 4.5 m open wind heavy duty coupling end		✓	4932471711	4058546296100
② Drop head bulb 16 mm cables	✓		48533811	4058546346133
Drop head straight 16 mm cables	✓		48533812	4058546346126
Funnel auger for 16 mm cables	✓		48533813	4058546346140
Small funnel auger for 22 mm cables	✓	✓	48533828	4058546346089
③ Medium funnel auger for 22 mm cables	✓	✓	48533831	4058546323479
Funnel auger for 32 mm cables		✓	48534831	4058546323561
Extra small opening tool for 16 mm cables	✓		48533814	4058546346157
Small opening tool for 16 mm cables	✓		48533815	4058546346164
Small opening tool for 22 mm cables	✓	✓	48533827	4058546346096
④ Small opening tool for 22 mm cables	✓	✓	48533835	4058546323516
Medium opening tool for 22 mm cables	✓	✓	48533836	4058546323523
Small opening tool for 32 mm cables		✓	48534835	4058546323608
Medium opening tool for 32 mm cables		✓	48534836	4058546323615
Spring cleaner for 16 mm cables	✓		48533816	4058546346171
⑤ Spring cleaner for 22 mm cables	✓	✓	48533826	4058546346102
50 mm root cutter for 22 mm cables	✓	✓	48533825	4058546346119
75 mm root cutter for 22 mm cables	✓	✓	48533832	4058546323486
100 mm root cutter for 22 mm cables	✓	✓	48533833	4058546323493
⑥ 150 mm root cutter for 22 mm cables	✓	✓	48533834	4058546323509
75mm root cutter for 32 mm cables		✓	48534832	4058546323578
100 mm root cutter for 32 mm cables		✓	48534833	4058546323585
150 mm root cutter for 32 mm cables		✓	48534834	4058546323592
Small straight auger for 22 mm cables	✓	✓	48533829	4058546346072
⑦ Medium straight auger for 22 mm cables	✓	✓	48533830	4058546323462
Straight auger for 32 mm cables		✓	48534830	4058546323554
75 mm chain knocker for 22 mm spirals	✓	✓	48533837	4058546323530
⑧ 100 mm chain knocker 22 mm cables	✓	✓	48533838	4058546323547
75 mm chain knocker for 32 mm spirals		✓	48534837	4058546323622
100 mm chain knocker 32 mm cables		✓	48534838	4058546323639
9pc head kit for 22 mm cables	✓	✓	48533840	4058546296148
⑨ 9pc head kit for 32 mm cables		✓	48534839	4058546296155
Small guide hose for FCSSM	✓		4932478410	4058546346010
⑩ Medium guide hose for FCSSM	✓		4932478409	4058546346003
Large guide hose for FSSM		✓	4932471720	4058546296193
Cable drum for 16mm spirals	✓		4932478412	4058546346034
⑪ Cable drum for 22mm spirals	✓	✓	4932478411	4058546346027
Cable drum for 32mm spirals		✓	4932471719	4058546296186
⑫ Pin key for all cables	✓	✓	4932471717	4058546296162

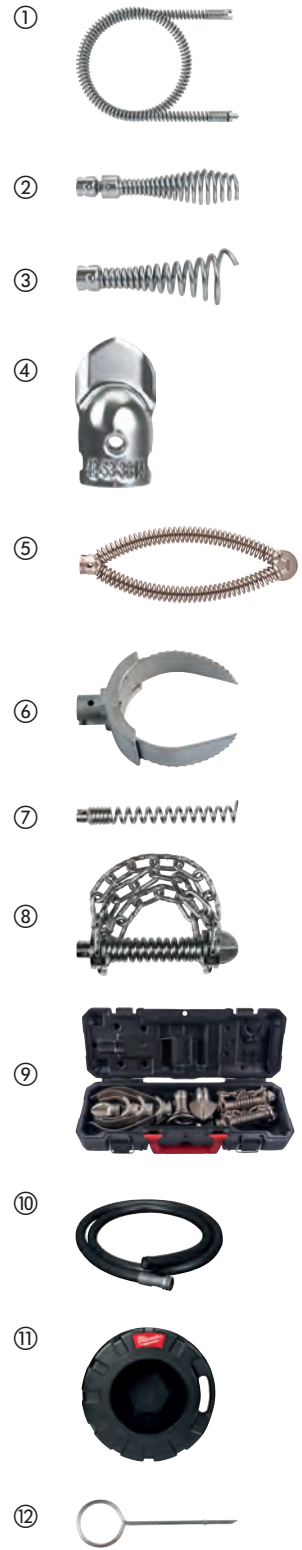

Inspection cameras

All extension cables are water splash and dust proof.

Extensions are attached between the base camera unit and standard supplied camera cable.

Description	Cable length (m)	Cable diameter (mm)	Fits MILWAUKEE® Inspection Cameras	Pack quantity	Min. order quantity	Article Number	EAN Code
Cable extension: Up to a maximum of 3 extensions can be fixed together	0.9	17	C12 IC	1	1	48530110	045242157747
① Cable extension: Up to a maximum of 5 extensions can be fixed together	0.9	17	C12 AVD, C12 AVA	1	1	48530141	045242216529
Replacement analog camera cable	0.9	9.5	C12 AVD, C12 AVA	1	1	4931419517	4002395828234
1m replacement cable camera for the M-spector camera	1	12	M12 IC AV3	1	1	48530150	045242344208
3m replacement cable camera for the M-spector camera	3	12	M12 IC AV3	1	1	48530151	045242344222
② 1 m articulating cable	1	12	M12 IC AV3	1	1	48530155	045242344215
③ Skid set for M18™SIC36	-	-	M18 SIC36	1	1	4931473616	4058546354923
④ Skid set for M18™SIC60	-	-	M18 SIC60	1	1	4931473638	4058546355142
⑤ Grounding kit for M18™SISH	-	-	M18 SISH	1	1	4931473526	4058546354022

①



②



③



④



⑤



Pipe threader dies

High performance threader dies ensure perfect threads and long lasting performance in combination with the MILWAUKEE® threaders

Dies are available in two types of thread geometries: BSPT (British Standard Pipe Taper) and NPT (National Taper Pipe)

Dies are available in two different grades: Alloy dies for long lasting performance on black and galvanised pipes and HS dies for best performance on stainless steel pipes

One set contains 4 single cutting dies that are needed to equip one die head

Description	Thread size (inch)	Pack quantity	Min. order quantity	Article Number	EAN Code
FPTD 1/2" NPT HS	1/2	1	1	48361107	045242608713
FPTD 3/4" NPT HS	3/4	1	1	48361108	045242608720
FPTD 1" NPT HS	1	1	1	48361109	045242608737
FPTD 1 1/4" NPT HS	1 1/4	1	1	48361110	045242608744
FPTD 1 1/2" NPT HS	1 1/2	1	1	48361111	045242608751
FPTD 2" NPT HS	2	1	1	48361112	045242608768
FPTD 1/2" BSPT Alloy	1/2	1	1	4932480227	4058546405120
FPTD 3/4" BSPT Alloy	3/4	1	1	4932480228	4058546405137
FPTD 1" BSPT Alloy	1	1	1	4932480229	4058546405144
FPTD 1 1/4" BSPT Alloy	1 1/4	1	1	4932480230	4058546405151
FPTD 1 1/2" BSPT Alloy	1 1/2	1	1	4932480231	4058546405168
FPTD 2" BSPT Alloy	2	1	1	4932480232	4058546405175
FPTD 1/2" BSPT HS	1/2	1	1	4932480233	4058546405182
FPTD 3/4" BSPT HS	3/4	1	1	4932480234	4058546405199
FPTD 1" BSPT HS	1	1	1	4932480235	4058546405205
FPTD 1 1/4" BSPT HS	1 1/4	1	1	4932480236	4058546405212
FPTD 1 1/2" BSPT HS	1 1/2	1	1	4932480237	4058546405229
FPTD 2" BSPT HS	2	1	1	4932480238	4058546405236



Pipe threader heads

Up to 50% lighter than competitive die heads

Available sizes from 1/2" up to 2"

Die heads always include a set of BSPT alloy dies

Description	Thread size (inch)	Pack quantity	Min. order quantity	Article Number	EAN Code
FPT2H 1/2" BSPT Alloy	1/2	1	1	4932480239	4058546405243
FPT2H 3/4" BSPT Alloy	3/4	1	1	4932480240	4058546405250
FPT2H 1" BSPT Alloy	1	1	1	4932480241	4058546405267
FPT2H 1 1/4" BSPT Alloy	1 1/4	1	1	4932480242	4058546405274
FPT2H 1 1/2" BSPT Alloy	1 1/2	1	1	4932480243	4058546405281
FPT2H 2" BSPT Alloy	2	1	1	4932480244	4058546405298
FPT114H 1/2" BSPT Alloy	1/2	1	1	4932480245	4058546405304
FPT114H 3/4" BSPT Alloy	3/4	1	1	4932480246	4058546405311
FPT114H 1" BSPT Alloy	1	1	1	4932480247	4058546405328
FPT114H 1 1/4" BSPT Alloy	1 1/4	1	1	4932480248	4058546405335
FPT2HK BSPT Alloy Packout Head Kit	1/2", 3/4", 1", 1 1/4", 1 1/2", 2"	6	1	4932480249	4058546405342
FPT114HK BSPT Alloy Packout Head Kit	1/2", 3/4", 1", 1 1/4"	4	1	4932480250	4058546405359



Caulk guns - System attachments

Description	Fits Milwaukee Caulk Guns	Pack quantity	Min. order quantity	Article Number	EAN Code
① 310 ml standard carriage. Accepts all standard 250 ml and 310 ml tubes/cartridges Includes plunger rod assembly (4932352937), piston for carriage assemblies and a feed screw (44700330)	C18 PCG	1	1	48081076	045242263127
② 310 ml standard carriage. Accepts all standard 250 ml and 310 ml tubes/cartridges Includes plunger rod assembly (4932430099), piston for carriage assemblies and a feed screw (44700330)	C12 PCG	1	1	48080900	045242286355
③ 310 ml aluminium sausage tube barrel. Accepts standard 310 ml "sausage style" material packs and 380 ml cartridges. Requires plunger rod 49520660	PCG 14 / 300, PCG 14 / 600	1	1	48081085	045242089246
④ 400 ml aluminium sausage tube barrel. Accepts standard 400 ml "sausage style" material packs (includes 2 end cups). Requires plunger rod (48091090) and piston (44700375)	C18 PCG, C12 PCG	1	1	4932352844	4002395375028
⑤ 600 ml aluminium sausage tube barrel. Accepts standard 600 ml "sausage style" material packs (includes 2 end cups). Requires plunger rod (48091091) and piston (44700375)	C18 PCG, C12 PCG	1	1	4932352845	4002395375035
⑥ 400 ml transparent sausage tube barrel. Accepts standard 400 ml "sausage style" material packs (includes 2 end cups). Requires plunger rod (48091090) and piston (44700375)	C18 PCG, C12 PCG	1	1	4932352842	4002395375004
⑦ 600 ml transparent sausage tube barrel. Accepts standard 600 ml "sausage style" material packs (includes 2 end cups). Requires plunger rod (48091091) and piston (44700375)	C18 PCG, C12 PCG	1	1	4932352843	4002395375011
⑧ Plunger rod assembly for 310 ml cartridges. For use with: 48081076 310 ml standard carriage	C18 PCG	1	1	4932352937	4002395375950
⑨ Plunger rod assembly for 310 ml carriage. For use with: 48080900 310 ml standard carriage	C12 PCG	1	1	4932430099	4002395377602
⑩ Plunger rod short (340 mm long). For use with: 48081075 carriage and 48081085 „sausage style“ barrel	PCG 14 / 300, PCG 14 / 600	1	1	49520600	045242190201
⑪ Plunger rod assembly for 400 ml sausage tube barrel. For use with: 4932352844 400 ml aluminium sausage tube barrel. 4932352842 400 ml transparent sausage tube barrel	C18 PCG	1	1	48091090	045242263158
⑫ Plunger rod assembly for 400 ml sausage tube barrel. For use with: 4932352844 400 ml aluminium sausage tube barrel. 4932352842 400 ml transparent sausage tube barrel	C12 PCG	1	1	4932430100	4002395377619
⑬ Plunger rod assembly for 600 ml sausage tube barrel. For use with: 4932352845 600 ml aluminium sausage tube barrel. 4932352843 600 ml transparent sausage tube barrel	C18 PCG	1	1	48091091	045242263165
⑭ Plunger rod assembly for 600 ml sausage tube barrel. For use with: 4932352845 600 ml aluminium sausage tube barrel. 4932352843 600 ml transparent sausage tube barrel	C12 PCG	1	1	4932430101	4002395377626
⑮ Piston for carriage assemblies	C18 PCG, C12 PCG	1	1	44700330	045242260928
⑯ Piston for sausage tube barrels	C18 PCG, C12 PCG	1	1	44700375	045242277438
⑰ Replacement nozzle	PCG 14 / 300, PCG 14 / 600, C18 PCG, C12 PCG	1	1	45760525	4002395775323

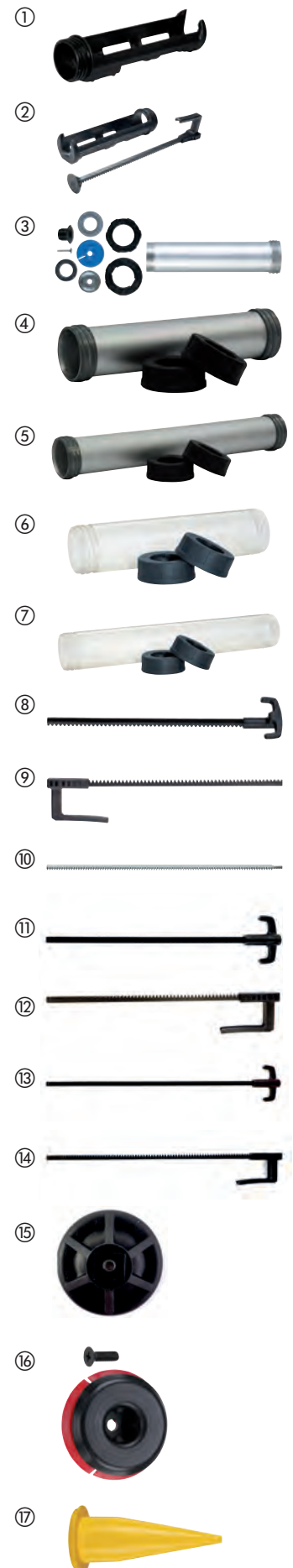

Electrical Test & Measuring - System attachments

Description	Pack quantity	Min. order quantity	Article Number	EAN Code
① Electrical test probes (max. 1000 Volts/ 10 Amps) heads 125 mm long	1	1	49771004	045242238965
② Electrical alligator clips (max. 1000 Volts/ 10 Amps)	1	1	49771005	045242238972



Heated jackets - System attachments

M18™ USB Power Source - M18™ USB PS HJ. Powers the jacket on M18™ battery packs. USB charging port for MP3 player, mobile phone, digital camera, GPS.
12 V Car Plug - 12 V CP HJ. Powers the jacket on any 12 V cigarette style outlet.

Description	Pack quantity	Min. order quantity	Article Number	EAN Code
① M18™ 2.1A USB controller (M18 USB PS HJ2)	1	1	4932471597	4058546294960
② M12™ car plug (12 V CP HJ)	1	1	4932430085	4002395377466



MILWAUKEE® ONE-KEY™ Bluetooth® tracking tag - BTT

Track with any item in your MILWAUKEE® ONE-KEY™ inventory. Simply pair the TICK™ with your chosen item and leverage ONE-KEY™ integrated tool tracking to locate your missing product Fully compatible with all ONE-KEY™ integrated tool tracking and inventory management features
IP68 - withstands toughest jobsite conditions
Withstands temperatures from +60 °C to -20 °C
3-year run time with built-in non-replaceable battery, eliminates the need to stock batteries
Identify a specific item or find an item, even if it cannot be visibly seen, with the new built-in speaker
Up to 90 m beacon range
5 seconds duty cycles
NFC allows you to pull data to troubleshoot
The QR code allows for 2 step activation, tracking when Bluetooth® isn't working and quickly identify specific item within the ONE-KEY™ software
The accelerometer will alert you if your item has been in use or is moved from where it belongs
Solid, one piece, construction makes for a stronger, more durable product



Description	Pack quantity	Min. order quantity	Article Number	EAN Code
MILWAUKEE® ONE-KEY™ Bluetooth® tracking tag - BTT	1	1	4933478640	4058546348335
MILWAUKEE® ONE-KEY™ Bluetooth® tracking tag - BTT - 10 pc	10	1	4933478643	4058546348366

M12™ / M18™ dust absorption system

Description	Fits MILWAUKEE® Dust Extractors	Pack quantity	Min. order quantity	Article Number	EAN Code
① Drilling nozzle	M18 CDEX / M18/28 CPDEX, M12 DE	2	1	49902301	045242337279
② Filter	M18 CDEX / M18/28 CPDEX, M12 DE	3	1	49902306	045242299454
③ Crevice nozzle	M12 DE	1	1	49902325*	045242297603
④ Filter set (3pc) Filter box, filter, box lid	M12 DE	3	1	49902340	045242299461
⑤ M18 & M28 Dustbox with filter box, filter	M18 CDEX / M18/28 CPDEX	4	1	49902342	045242341948
⑥ Dust thru-box to allow connection of the M12 DE to an independent dust extraction / vacuum cleaner. Outlet nozzle: Ø 37 mm outside / Ø 32 mm inside		1	1	4932430479	4002395381401
Drilling shroud - PHDE152		1	1	4932471990	4058546298890



Concrete vibrator heads

Description	Pack quantity	Min. order quantity	Article Number	EAN Code
Vibrator head 38 mm	1	1	4932478612	4058546348052
Vibrator head 50 mm	1	1	4932478613	4058546348069
Vibrator head 25 mm	1	1	4932479839	4058546376338
Vibrator head 63 mm	1	1	4932479840	4058546376345



Concrete vibrator shafts

Description	Pack quantity	Min. order quantity	Article Number	EAN Code
Vibrator shaft 4 m	1	1	4932478610	4058546348038
Vibrator shaft 2 m	1	1	4932478611	4058546348045



Dust absorption solutions - System attachments

Vacuum cleaners

	Description	Fits MILWAUKEE® Dust Extractors	Pack quantity	Min. order quantity	Article Number	EAN Code
①	Extraction hose, anti static, 4 m long 36 mm diameter with tool adaptor	AS 300 ELCP, AS 500 ELCP, AS 300 EMAC	1	1	4932352311	4002395369706
②	Extraction hose. 3.5 m long 32 mm diameter with tool adaptor	AS 250 ECP	1	1	4932352312	4002395369713
③	Adaptor for direct connection of suction hose 330552	AS 1, AS 2 C	1	1	4932430833	4002395384952
④	Universal adaptor Ø 35 / 33 / 27 mm	WDC 1400 A, AS 1, AS 2 C, AS 3 W, ASE 1400, ASM 1400	1	1	4932369282	4002395338412
⑤	Ø 35 mm suction tube 50 cm plastic	ASE 1400, AS 1, AS 2 C, ASM 1400	1	1	4932346620	4002395319503
⑥	Extraction hose Ø 35 mm / 5 m	ASE 1400, ASM 1400	1	1	4932373626	4002395351534
⑦	Ø 50 mm wide gap nozzle.	ASE 1400, AS 1, AS 2 C, ASM 1400	1	1	4932316070	4002395310449
⑧	Ø 50 mm to Ø 35 mm reduction sleeve	ASE 1400, AS 1, AS 2 C, ASM 1400	1	1	4932316074	4002395310456
⑨	5 x 25 l fleece filter bags	AS 250 ECP	5	1	4932352306	4002395369652
⑩	5 x 30 l fleece filter bags	AS 300 ELCP, AS 300 EMAC, AS 300 ELAC	5	1	4932352307	4002395369669
⑪	5 x 50 l fleece filter bags	AS 500 ELCP	5	1	4932352308	4002395369676
⑫	Filter bags: 5 x plastic bags, 30 l	AS 250 ECP, AS 300 ELCP, AS 300 EMAC	5	1	4932352309	4002395369683
⑬	Filter bags: 5 x plastic bags, 50 l	AS 500 ELCP	5	1	4932352310	4002395369690
⑮	Filter bags. Heavy duty 5 x 25 l paper bags	RSE 1400	5	1	4932373852	4002395352821
⑯	Filter bags. Heavy duty 5 x 50 l paper bags	ASE 1400, ASM 1400	5	1	4932373621	4002395351503
⑰	Fleece filter bags for AS 30/42	AS 30 LAC, AS 30 MAC, AS 42 MAC	5	1	4932459689	4058546028619
⑱	Disposable bags 30 l	AS 42 MAC, AS 30 MAC, AS 30 LAC	5	1	4932459690	4058546028626
⑲	Filter cartridge	AS 250 ECP, AP 250 ECP	1	1	4932352303	4002395369621
⑳	Filter cartridge	AS 300 ELCP, AS 500 ELCP, AS 2-250 ELCP	1	1	4932352304	4002395369638
㉑	Filter cartridge	AS 300 EMAC, AS 300 ELAC	2	1	4932352305	4002395369645
㉒	Filter cartridge, 7000 cm ² , BIA usage Cat. C	AS 3 W	1	1	4932346588*	4002395319473
㉓	Flat folded polyester filter cartridge, 2 pcs	ASE 1400, ASM 1400	1	1	4932373623	4002395351510
㉔	PTFE flat filter	AS 30 LAC, AS 42 MAC, AS 30 MAC	1	1	4932459687	4058546028596
㉕	Motor cooling filter	AS 42 MAC, AS 30 MAC, AS 30 LAC	1	1	4932459688	4058546028602
㉖	Metal push handle	AS 42 MAC, AS 30 MAC, AS 30 LAC	1	1	4932459691	4058546028633

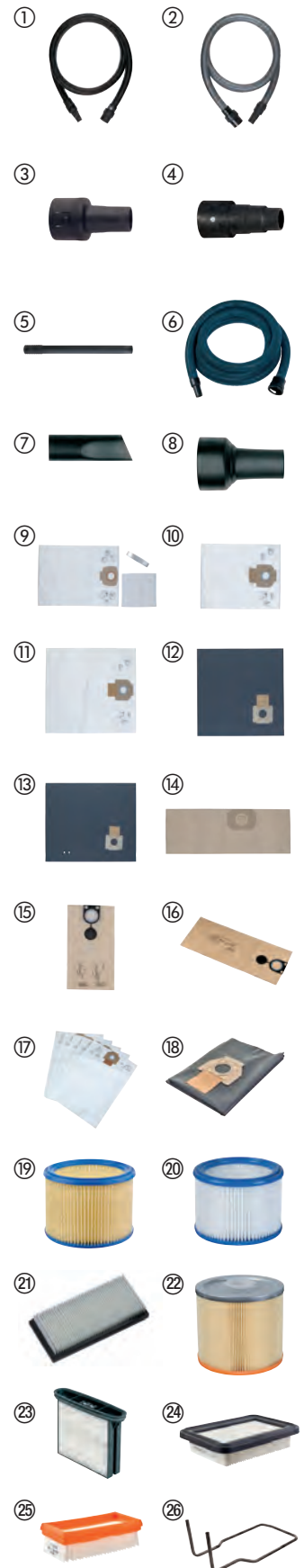



Hand Tools

Tape measures **STUD™ II**



- EXO 360™ blade technology delivers long lasting, rip and wear resistance.
- Strong magnet at start of the tape allows easy hooking onto flat surfaces and round pipe.
- Up to 4 m standout - higher standout for higher efficiency and higher reach.
- Anti-tear coating - reinforces the first 15 cm of the blade.
- 2 sided blade printing - increases the readability.
- Patented finger stop - protects fingers from blade retraction.
- ABS housing with impact resistant overmold for more comfort and jobsite durability.
- Wire form belt clip - reduces pocket tearing.
- Tool lanyard hole - Ready for quick and easy tethering.
- Class II accuracy.

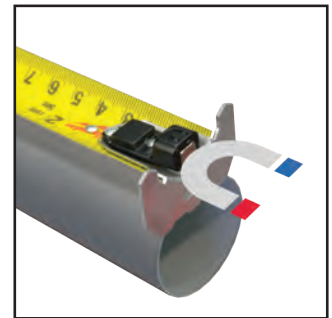

Strong magnet



4M STANDOUT

Description	Length (m)	Blade width (mm)	Pack quantity	Min. order quantity	Article Number	EAN Code
STUD Gen2 5 m	5	33	1	6	4932471626	4058546295257
STUD Gen2 8 m	8	33	1	6	4932471627	4058546295264
STUD Gen2 5 m 16 ft	5 / 16'	33	1	6	4932471628	4058546295271
STUD Gen2 8 m 26 ft	8 / 26'	33	1	6	4932471629	4058546295288



Premium wide blade tape measures

- Up to 4 m standout - higher standout for higher efficiency and higher reach.
- Anti-tear coating - reinforces the first 15 cm of the blade.
- 2 sided blade printing - increases the readability.
- Impact resistant 5 points - reinforces the frame and makes it more durable.
- Patented finger stop - protects fingers from blade retraction.
- Wire form belt clip - reduces pocket tearing.
- Nylon bond blade protection - reduces tape tear.
- Tool lanyard hole - Ready for quick and easy tethering.



4M STANDOUT



Description	Length (m)	Blade width (mm)	Pack quantity	Min. order quantity	Article Number	EAN Code
Premium wide blade 5 m	5	33	1	6	4932471815	4058546297145
Premium wide blade 8 m	8	33	1	6	4932471816	4058546297152
Premium wide blade 5 m 16 ft	5 / 16'	33	1	6	4932471817	4058546297169
Premium wide blade 8 m 26 ft	8 / 26'	33	1	6	4932471818	4058546297176

Magnetic tape measures GEN III



- Strong magnet at start of the tape allows easy hooking onto flat surfaces and round pipe.
- Compact and ergonomic design.
- Improved standout up to 3.4 m.
- Nylon non-reflective bond blade protection, up to 10x more resistant to jobsite damage.
- 27 mm blade with double sided printing on tape for easier readability.
- Patented finger stop: stable when stands alone.
- 5-point reinforced frame for jobsite durability.
- Class II accuracy.
- Architect scale provides easy calculating of scaled drawings.



Description	Length (m)	Blade width (mm)	Pack quantity	Min. order quantity	Article Number	EAN Code
Magnetic Tape Measure 5 m	5	27	1	6	4932464599	4058546225445
Magnetic Tape Measure 8 m	8	27	1	6	4932464600	4058546225452
Magnetic Tape Measure 10 m	10	27	1	6	4932464601	4058546225469
Magnetic Tape Measure 5 m - 16 ft	5 / 16'	27	1	6	4932464602	4058546225476
Magnetic Tape Measure 8m - 26 ft	8 / 26'	27	1	6	4932464603	4058546225483



Tape measure Autolock

- Autolock brake: tape automatically locks in place as blade is pulled out.
- Nylon coated blade protection against debris, dirt and water.
- 5 Point reinforced housing for outstanding tape lifetime.
- ABS housing with impact resistant overmold for more comfort and jobsite durability.
- Compact design and comfortable size.
- Heavy Duty belt clip.
- Class II accuracy.
- Bulk packed, order in multiples of 6pcs.



Description	Length (m)	Blade width (mm)	Pack quantity	Min. order quantity	Article Number	EAN Code
Tape measure Autolock 5 m	5	25	1	6	4932464663	4058546226084
Tape measure Autolock 8 m	8	25	1	6	4932464664	4058546226091
Tape measure Autolock 5 m - 16 ft	5	25	1	6	4932464665	4058546226107
Tape measure Autolock 8 m - 26 ft	8	25	1	6	4932464666	4058546226114

Tape measures pro compact

- Improved ergonomics and comfortable size.
- Jobsite durability.
- 5-point reinforced housing.
- 2G nylon coated blade protection.
- Improved tape tear and flexibility.
- Withstands 3 m drop test.
- Non magnetic.
- Heavier font on measurements for better readability.
- Smaller compact hook design.
- Back rest for easy vertical measuring.
- Improved belt clip: more pocket friendly.



Description	Length (m)	Blade width (mm)	Pack quantity	Min. order quantity	Article Number	EAN Code
Tape measure pro compact C3/16	3	16	1	12	4932459591	4058546027636
Tape measure pro compact C5/19	5	19	1	12	4932459592	4058546027643
Tape measure pro compact C5/25	5	25	1	6	4932459593	4058546027650
Tape measure pro compact C8/25	8	25	1	6	4932459594	4058546027667
Tape measure pro compact C5-16/25	5 / 16'	25	1	24	4932459595	4058546027674
Tape measure pro compact C8-26/25	8 / 26'	25	1	12	4932459596	4058546027681

Tape measure with LED Light

- 19 LUX LED Light: helps finding measured spot.
- Nylon lacquer blade protection against debris, dirt and water.
- 4 Point reinforced housing for outstanding tape lifetime.
- ABS housing with impact resistant overmold for more comfort and jobsite durability.
- Compact design and comfortable size.
- Magnet on the rear side of the tape for attaching to metal tool boxes and other metal surfaces.
- 2x CR2016 batteries are included in the delivery scope.
- Class II accuracy.
- Bulk packed, order in multiples of 12 pcs.



Description	Length (m)	Blade width (mm)	Pack quantity	Min. order quantity	Article Number	EAN Code
3 m/ 10 ft tape measure with LED	3	12	1	12	48226602	045242529285

Tape measures slimline

- Very compact and improved ergonomic design.
- Nylon coated blade protection against debris, dirt and water.
- ABS housing with softgrip rubber gripping area for extra comfort and jobsite durability.
- 4-point reinforced frame.
- Flat base for horizontal stability and back rest for easy vertical measuring.
- Belt clip.
- Class II accuracy.
- Orders are only possible in master cartons with 24, 12 or 6 tapes depending on sku.



Description	Length (m)	Blade width (mm)	Pack quantity	Min. order quantity	Article Number	EAN Code
S3 / 16	3	16	1	12	48227703	045242512898
S5 / 19	5	19	1	12	48227705	045242512904
S5 / 25	5	25	1	6	48227706	045242512911
S8 / 25	8	25	1	6	48227708	045242512928
S5-16 / 25	5/16'	25	1	24	48227717	045242512935
S8-26 / 25	8/26'	25	1	24	48227726	045242512942

Tape measure - 2 m / 6 ft



- 5-point reinforced frame for job site durability.
- Heavy duty blade with 13 mm blade width.
- Double sided nylon bond blade protection for extreme tape durability against dust, dirt, debris and water.
- Compact design and overmould gripping area for extra comfort and durability.
- Bulk packed, order in multiples of 12 pcs.

Description	Length (m)	Pack quantity	Min. order quantity	Article Number	EAN Code
2 m/ 6 ft metric & imperial tape measure	2	1	12	48225502	045242468034

Composite folding rule

- Locks at 90°/180°.
- Angle reference, rust free.
- Water resistant.
- Wear resistant markings.



Description	Length (m)	Blade width (mm)	Accuracy	Links	Hinge	Pack quantity	Min. order quantity	Article Number	EAN Code
Composite folding rule	2	15 x 3.20	Class 2	10	Plastic and stainless steel	1	10	4932459301	4058546002671

Wood folding rule

- Locks at 90°/180°.
- Angle reference.



Description	Length (m)	Blade width (mm)	Accuracy	Links	Hinge	Pack quantity	Min. order quantity	Article Number	EAN Code
Wood folding rule	2	16 x 3.20	Class 3	10	Brass	1	12	4932459302	4058546002688

Slim wood folding rule

- Locks at 180°.
- Flexible slim design.



Description	Length (m)	Blade width (mm)	Accuracy	Links	Hinge	Pack quantity	Min. order quantity	Article Number	EAN Code
Slim wood folding rule	2	16 x 2.70	Class 3	10	Brass	1	10	4932459303	4058546002695

Long open tapes

- Steel blade design with nylon clad (extra thick nylon coating) for increased durability.
- Best in class stretch performance: up to 50% less stretch vs. fiberglass tapes.
- Ultra durable design: reinforced metal handle and drop durability.
- 3:1 clutched planetary gearing for 10x longer gear durability and smooth rewind.
- GRIME GUARD: debris wiper keeps blade clean and clear of abrasive material.
- Class II accuracy.
- 2 sided scale printing. Metric measurements shown on the top side and imperial (inches and feet) on the underside of the blade.

Description	Length (m)	Blade width (mm)	Pack quantity	Min. order quantity	Article Number	EAN Code
① Long open tape combi 30 m/ 100 ft	30	13	1	1	48225203	045242486069
② Long open tape combi 100 m/ 330 ft	100	9.5	1	1	48225211	045242486076



Fibreglass long tapes

- Fibreglass blade ensures a low tape weight.
- 3:1 clutched planetary gearing for 10x longer gear durability and smooth rewind.
- GRIME GUARD: debris wiper keeps blade clean and clear of abrasive material.
- 2 sided scale printing. Metric measurements shown on the top side and imperial (inches and feet) on the underside of the blade.

Description	Length (m)	Blade width (mm)	Pack quantity	Min. order quantity	Article Number	EAN Code
① Fibreglass long tape combi 30 m/ 100 ft	30	13	1	1	48225330	045242527731
② Fibreglass long tape combi 60 m/ 200 ft	60	13	1	1	48225360	045242527748



Long closed tapes

- Single sided 30 m metric tape with 9.5 mm blade width.
- GRIME GUARD: debris wiper keeps blade clean and clear of abrasive material.
- Ultra durable design: reinforced metal frame housing, reinforced handle and steel blade with nylon coating.
- 3:1 clutched planetary gearing for 10x longer gear durability and smooth rewind.
- Class II accuracy.



Description	Length (m)	Blade width (mm)	Pack quantity	Min. order quantity	Article Number	EAN Code
Long closed tape 30 m	30	9.5	1	1	48225103	045242486106

Digital levels



Description	Length (cm)	Handles	Pack quantity	Min. order quantity	Article Number	EAN Code
Digital level 60 cm	60	0	1	1	4933471978	4058546298777
Digital level 120 cm	120	2	1	1	4933471979	4058546298784

Expandable level



- Cover any length from 200 cm - 366 cm with laser etched measurements.
- SHARPSITE[™] vial technology improves the readability of the vial.
- Reinforced internal components protect the level from damage or wear.
- Precision milled measuring surface provides accuracy in all working positions.
- Accurate to 0.029° (0.0005 7/ in, 0.5 mm/ m) in normal and reverse position.
- High contrast vial system is easy to clean and optimises visibility.
- Full grip frame for improved ergonomics in transport & application.
- Secure tool-removable stand offs.



Description	Length (cm)	Handles	Pack quantity	Min. order quantity	Article Number	EAN Code
Expandable 200 cm - 366 cm	200 - 366	2	1	1	4932471355	4058546289836

30 YEARS ACCURACY GUARANTEE
 JAHRE GENAUIGKEITSGARANTIE
 ANS DE PRECISION GARANTIE
 www.milwaukeetool.eu



REDSTICK™ BACKBONE™ box levels



- All-metal BACKBONE™. Strong and durable frame. Reinforced vial retention.
- SHARPSITE™ vial technology improves the readability of the vial.
- Wide, durable handles for comfort and portability.
- Precision milled measuring surface provides accuracy in all working positions.
- High contrast vial system is easy to clean and optimises visibility.
- Shock absorbing end caps protect the frame.
- Overmolded, non-slip grips stick to the wall and prevent sliding.
- Durable, all-metal hang hole for storage.
- Accurate to 0.029° (0.0005 ʹ in, 0.5 mm/ m) in normal and reverse position.
- Amplified rare earth magnets for maximum holding power (only magnetic levels).



Strong and durable frame, all metal reinforced BACKBONE™



SHARPSITE™ vial technology improves the readability of the vial

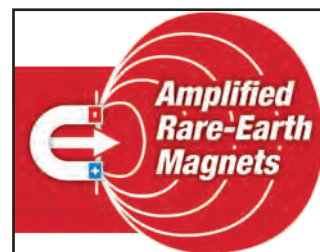

Amplified rare earth magnets for maximum holding power (only magnetic levels)



30 YEARS ACCURACY GUARANTEE
 JAHRE GENAUIGKEITSGARANTIE
 ANS DE PRECISION GARANTIE
www.milwaukeetool.eu

Description	Length (cm)	Handles	Pack quantity	Min. order quantity	Article Number	EAN Code
40 cm magnetic	40	0	1	1	4932459061	4002395280322
60 cm magnetic	60	0	1	1	4932459063	4002395280346
80 cm magnetic	80	1	1	1	4932459065	4002395280360
100 cm magnetic	100	0	1	1	4932459067	4002395280384
120 cm magnetic	120	2	1	1	4932459069	4002395281008
180 cm magnetic	180	2	1	1	4932459071	4002395281046
200 cm magnetic	200	2	1	1	4932459073	4002395281060
240 cm magnetic	240	2	1	1	4932459075	4002395281084
40 cm non-magnetic	40	0	1	1	4932459060	4002395280315
60 cm non-magnetic	60	0	1	1	4932459062	4002395280339
80 cm non-magnetic	80	1	1	1	4932459064	4002395280353
100 cm non-magnetic	100	0	1	1	4932459066	4002395280377
120 cm non-magnetic	120	2	1	1	4932459068	4002395280391
180 cm non-magnetic	180	2	1	1	4932459070	4002395281015
200 cm non-magnetic	200	2	1	1	4932459072	4002395281053
240 cm non-magnetic	240	2	1	1	4932459074	4002395281077
End-caps for REDSTICK™ BACKBONE™ levels			2	1	4932459680	4058546028527

REDSTICK[™] compact box levels



- SHARPSITE[™] vial technology improves the readability of the vial.
- Compact and durable frame.
- Bottom milled measuring surface provides maximum accuracy.
- High contrast vial system is easy to clean and optimises visibility.
- Amplified rare earth magnets for maximum holding power (only magnetic levels).
- Accurate to 0.029° (0.0005 1/16 in, 0.5 mm/m) in standard position.
- Shock absorbing rubber end caps.



Description	Length (cm)	Handles	Pack quantity	Min. order quantity	Article Number	EAN Code
40 cm magnetic	40	0	1	1	4932459079	4002395281725
60 cm magnetic	60	0	1	1	4932459081	4002395281749
80 cm magnetic	80	0	1	1	4932459083	4002395281763
100 cm magnetic	100	0	1	1	4932459085	4002395281787
120 cm magnetic	120	0	1	1	4932459087	4002395282401
180 cm magnetic	180	0	1	1	4932459089	4002395282425
40 cm non-magnetic	40	0	1	1	4932459078	4002395281718
60 cm non-magnetic	60	0	1	1	4932459080	4002395281732
80 cm non-magnetic	80	0	1	1	4932459082	4002395281756
100 cm non-magnetic	100	0	1	1	4932459084	4002395281770
120 cm non-magnetic	120	0	1	1	4932459086	4002395281794
180 cm non-magnetic	180	0	1	1	4932459088	4002395282418
End-caps for REDSTICK [™] compact levels			2	1	4932459681	4058546028534

REDSTICK[™] concrete levels



- SHARPSITE[™] vial technology improves the readability of the vial.
- Ergonomic keyhole profile delivers maximum durability and continuous grip across entire level.
- Wide magnesium base for enhanced screeding functionality and cleanability.
- Dedicated working edges include a rounded and a squared bottom edge for cutting and finishing concrete.
- High contrast vial system is easy to clean and optimises visibility.
- Vial surrounds are optimised for screeding applications and cleanability.
- Slope vials rated for 1/8" & 1/4" (1% & 2%).



Description	Length (cm)	Handles	Pack quantity	Min. order quantity	Article Number	EAN Code
60 cm non-magnetic	60	0	1	1	4932459893	4058546030650
120 cm non-magnetic	120	0	1	1	4932459894	4058546030667
180 cm non-magnetic	180	0	1	1	4932459895	4058546030674

Slim box levels



- 2 solid acrylic vials. Shockproof and UV resistant.
- Precision milled measuring surface up to 120 cm provides maximum accuracy.
- Shock absorbing end caps.
- Durable hang hole for storage.
- VPA third party certificate on accuracy.
- Accurate to 0.029° (0.0005 "/in, 0.5 mm/ m) in standard position.



10 YEARS ACCURACY GUARANTEE
 JAHRE GENAUIGKEITSGARANTIE
 ANS DE PRECISION GARANTIE
 ① www.milwaukeetool.eu

Description	Length (cm)	Pack quantity	Min. order quantity	Article Number	EAN Code
20 cm magnetic	20	1	10	4932478897	4058546361792
40 cm magnetic	40	1	1	4932464854	4058546227999
60 cm magnetic	60	1	1	4932464855	4058546228002
100 cm magnetic	100	1	1	4932464856	4058546228019
180 cm magnetic	180	1	1	4932464857	4058546228026
① 20 cm non-magnetic	20	1	10	4932472091	4058546324872
40 cm non-magnetic	40	1	1	4932459090	4002395282432
60 cm non-magnetic	60	1	1	4932459091	4002395282449
80 cm non-magnetic	80	1	1	4932459092	4002395282456
100 cm non-magnetic	100	1	1	4932459093	4002395282463
120 cm non-magnetic	120	1	1	4932459094	4002395282470
180 cm non-magnetic	180	1	1	4932459095	4002395282487
200 cm non-magnetic	200	1	1	4932459590	4058546027629



I-beam levels



- Lightweight reinforced aluminium frame.
- Magnetic edge allows hands free use when working with metal.
- Accurate to 0.029° (0.0005 "/in, 0.5 mm/ m) in normal and reverse position.
- Pitch vial for easy reading of 1 and 2 degree pitch.
- High contrast vial surrounds for maximised visibility.
- Shock absorbing end caps.



10 YEARS ACCURACY GUARANTEE
 JAHRE GENAUIGKEITSGARANTIE
 ANS DE PRECISION GARANTIE
 ① www.milwaukeetool.eu

Description	Length (cm)	Handles	Pack quantity	Min. order quantity	Article Number	EAN Code
I-Beam level magnetic - 60 cm	60	1	1	1	4932478565	4058546347581
I-Beam level magnetic - 120 cm	120	2	1	1	4932478566	4058546347598
I-Beam level magnetic - 200 cm	200	2	1	1	4932478567	4058546347604

REDCAST die-cast levels



- 2 solid acrylic vials. Shockproof and UV resistant.
- 2 heavy duty cast aluminium "anvil" strike pads for trowel blows during tile work.
- Drill bit diameter gauge in the level's profile from 5 to 12 mm.
- Precision milled measuring surface provides maximum accuracy.
- Durable hang hole for storage.
- VPA third party certificate on accuracy.
- Accurate to 0.029° (0.0005 ʹ/ in, 0.5 mm/ m).



10 YEARS ACCURACY GUARANTEE
 JAHRE GENAUIGKEITSGARANTIE
 ANS DE PRÉCISION GARANTIE
 ⓘ www.milwaukeetool.eu

Description	Length (cm)	Pack quantity	Min. order quantity	Article Number	EAN Code
REDCAST die-cast level 60 cm	60	1	1	4932459098	4002395283118
REDCAST die-cast level 80 cm	80	1	1	4932459099	4002395283125

Block torpedo level



- SHARPSITE[™] vial technology improves the readability of the vial.
- Locking 360° adjustable vial. Identify and repeat any angle needed on the jobsite. Lock vial in place to keep accuracy in and out of pocket/ pouch.
- Amplified rare earth magnets for maximum holding power.
- Reinforced plumb vials. Solid, acrylic block vials offer maximum durability.
- Die cast aluminium body withstands the conditions of the jobsite.
- Precision milled measuring surface provides maximum accuracy.
- Lanyard hole for use with all most prevention programs.
- Accurate to 0.029° (0.0005 ʹ/ in, 0.5 mm/ m).



30 YEARS ACCURACY GUARANTEE
 JAHRE GENAUIGKEITSGARANTIE
 ANS DE PRÉCISION GARANTIE
 ⓘ www.milwaukeetool.eu

Description	Length (cm)	Pack quantity	Min. order quantity	Article Number	EAN Code
Block torpedo level	25	1	1	4932459096	4002395282494

Billet torpedo level



- Amplified rare earth magnets for maximum holding power.
- Maximised viewing area. Easily read slope in 1/8" or 1/4" per foot in either direction.
- Reinforced acrylic vials offer maximum durability.
- Weld clearance. Easily level over weld joints in pipes and other materials.
- Optimised V-groove design for stability on non-ferrous pipes.
- Laser etched ruled edge for quick measurements on material.
- Slim, tapered design for easy sliding in and out of pockets and pouches.



10 YEARS ACCURACY GUARANTEE
 JAHRE GENAUIGKEITSGARANTIE
 ANS DE PRÉCISION GARANTIE
 ⓘ www.milwaukeetool.eu

Description	Length (cm)	Pack quantity	Min. order quantity	Article Number	EAN Code
Billet torpedo level	17	1	1	4932459097	4002395283101

Pocket level



- 360° adjustable vial for reading angles.
- Locking mechanism for repetitive use in and out of pocket/ pouch.
- Amplified rare-earth magnets for maximum holding power.
- V-groove for leveling on pipes.
- Milled edge to ensure accuracy.
- Compact size for jobsite functionality.



10 YEARS ACCURACY GUARANTEE
 JAHRE GENAUIGKEITSGARANTIE
 ANS DE PRECISION GARANTIE
 ① www.milwaukeetool.eu

Description	Length (cm)	Pack quantity	Min. order quantity	Article Number	EAN Code
Pocket level	7.8	1	6	4932459597	4058546027698

Compact torpedo



- SHARPSITE™ pitch vial for easy reading of 1 and 2 degree pitch.
- Sub compact design for working in tight spaces.
- Optimized V-groove design for stability of rounded surfaces.
- Weld clearance to level over weld lines in pipe and other material.
- Amplified rare earth magnets for maximum holding power.
- Accurate to 0.029° (0.0005" / in, 0.5 mm/ m).



Description	Length (cm)	Pack quantity	Min. order quantity	Article Number	EAN Code
Compact torpedo	7.6	1	1	4932472122	4058546325183

Minibox level



- Lightweight aluminium box profile fits easily into your tool belt or pocket.
- Solid acrylic vial. Shockproof and UV resistant vials.
- Shockproof end caps.
- Accurate to 0.029° (0.0005" / in, 0.5 mm/ m) in standard position.
- VPA third party certificate on accuracy.



10 YEARS ACCURACY GUARANTEE
 JAHRE GENAUIGKEITSGARANTIE
 ANS DE PRECISION GARANTIE
 ① www.milwaukeetool.eu

Description	Length (cm)	Pack quantity	Min. order quantity	Article Number	EAN Code
Minibox level	10	1	10	4932459100	4002395283446

Chalk reel

- Extra bold lines - 2 mm thick line for maximum visibility.
- Planetary gear system for increased durability.
- 4/1 gear ratio for fast line retraction.
- Large chalk capacity.
- Easy refills due to the extra large quick turn opening.
- Easy line securing due to the line lock.

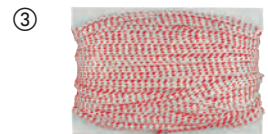

Description	Pack quantity	Min. order quantity	Article Number	EAN Code
① 30 m large capacity chalk reel	1	1	4932471634	4058546295332
② 45 m large capacity chalk reel	1	1	4932471635	4058546295349
③ 30 m replacement line chalk reel	1	1	4932471636	4058546295356
45 m replacement line chalk reel	1	1	4932471637	4058546295363

Framing Square

- Reinforced frame.
- Laser etched markings provide superior visibility.
- Precision scribe notches for easy marking.
- Common conversion table.
- Markings to assist in angle finding.



Description	Length (cm)	length (Inch)	Pack quantity	Min. order quantity	Article Number	EAN Code
Framing square metric	40 x 60	-	1	1	4932472126	4058546325220
Framing square imperial	-	16 x 24	1	1	4932472125	4058546325213

Rafter Square

- Precision scribe notches for easy marking.
- High visibility laser etched markings.
- Pipe prop to assist in cutting pipe materials.
- Increased heel width for improved grip.



Description	Length (cm)	length (Inch)	Pack quantity	Min. order quantity	Article Number	EAN Code
Rafter square metric	18	-	1	1	4932472124	4058546325206
Rafter square imperial	-	7	1	1	4932472123	4058546325190

INKZALL™ markers

- Stays sharp, doesn't mushroom or push back under pressure.
- Acrylic nib ideal for rough surfaces such as OSB and concrete.
- Marker continues to write after 72+ hours of cap off time.
- For use on concrete, wood, metal, plywood, OSB, plastic.
- Can be used on wet, oily, dusty, rusty, with debris surfaces.
- Quick dry time – reduced smearing markings on PVC, metal surfaces.
- Thin body for use in restricted areas.
- Helmet clip – can be clipped to the construction site cap, trousers, overalls.
- Easy open cap for one hand operation.
- Anti-Roll design - won't roll off surfaces.

Description	Colour	Tip	Pack quantity	Min. order quantity	Article Number	EAN Code
① INKZALL™ marker*	Black	1 mm	1	36	48223100	045242319473
② INKZALL™ marker*	Red	1 mm	1	36	48223170	045242355259
③ INKZALL™ marker*	Blue	1mm	1	36	4932492126	4058546414931
④ INKZALL™ marker	Green	1mm	1	36	4932492127	4058546414948
⑤ INKZALL™ marker with stylus	Black	1 mm	1	1	48223101	045242297436
⑥ INKZALL™ fine tip markers	Black	0.6 mm	4	1	48223154	045242479764
⑦ INKZALL™ colour markers Blue, Red, Green, Black		1 mm	4	1	48223106	045242333585
⑧ INKZALL™ chisel point marker	Black	1- 4,8 mm	1	1	48223103	045242333608

* Orders are only possible in master cartons (contains 36 x 48223100). Minum order quantity is 36 pcs (= 1 master carton). Order quantities greater than 36 pcs are to be ordered in multiples of 36 pcs (i.e. 72, 108, 144, 180...).



INKZALL™ chisel tip markers

- Marker continues to write after 72+ hours of cap off time.
- Can be used on wet, oily, dusty, rusty, with debris surfaces.
- For use on concrete, wood, metal, plywood, OSB, plastic.
- Quick dry time – reduced smearing markings on PVC, metal surfaces.
- Easier to read from a distance due to the increased chisel tip sizes.

Description	Colour	Tip	Pack quantity	Min. order quantity	Article Number	EAN Code
① INKZALL™ black chisel tip marker L (3 pc)	Black	6.2 mm	3	1	4932471554	4058546294533
② INKZALL™ black chisel tip marker L	Black	6.2 mm	1	12	4932471555	4058546294540
③ INKZALL™ red chisel tip marker L	Red	6.2 mm	1	12	4932471556	4058546294557
④ INKZALL™ blue chisel tip marker L	Blue	6.2 mm	1	12	4932471557	4058546294564
⑤ INKZALL™ black chisel tip marker XL (1 pack)	Black	14.5 mm	1	1	4932471558	4058546294571
⑥ INKZALL™ black chisel tip marker XL	Black	14.5 mm	1	12	4932471559	4058546294588
⑦ INKZALL™ red chisel tip marker XL	Red	14.5 mm	1	12	4932471560	4058546294595
⑧ INKZALL™ blue chisel tip marker XL	Blue	14.5 mm	1	12	4932471561	4058546294601



INKZALL[™] liquid paint markers

- Valve action marker.
- Durable acrylic nib for the most demanding environmental conditions: surface temperature from -10° up to + 145°.
- Marks on dark surfaces where traditional markers would not be easily visible.
- Can be used on rough, dirty and greasy surfaces.
- For use on concrete, black pipe, aluminium, PVC, steel & stainless steel, rubber and tyres.
- 10 seconds dry time.
- Water and UV resistant markings.
- Permanent markers. Markings last up to 6 months.
- Metal barrel for construction site durability.
- Xylene-free paint.
- **IMPORTANT:** Shake the marker with the cap on. Remove the cap and carefully pump it up and down until ink flows into the nib.



Description	Colour	Pack quantity	Min. order quantity	Article Number	EAN Code
① INKZALL [™] liquid paint marker	Yellow	1	12	48223721	045242363377
② INKZALL [™] liquid paint marker	White	1	12	48223711	045242363360
③ INKZALL [™] liquid paint marker	Black	1	12	48223731	045242363384
④ INKZALL [™] liquid paint marker	Blue	1	12	4932492144	4058546415112
⑤ INKZALL [™] liquid paint marker	Red	1	12	4932492143	4058546415105

INKZALL[™] highlighters

- Durable tip stays sharp longer.
- No smearing, doesn't bleed through.
- Non-toxic ink, ASTM D 4236 certification.
- Ideal for architectural drawings, labels, office paper.
- Anti-roll body design for better grip on smooth surfaces.
- Construction helmet clip: the INKZALL[™] highlighters can be clipped to the helmet, trousers, overalls, etc.
- Lanyard hole, e.g. to attach the INKZALL[™] highlighters to the belt.



Description	Pack quantity	Min. order quantity	Article Number	EAN Code
① INKZALL [™] highlighter - yellow	5	1	48223201	045242482573
② INKZALL [™] highlighter - coloured	5	1	48223206	045242482580

INKZALL[™] fine tip pens

- Approx. 0.6 mm tip.
- Clog resistant.
- Main applications: marking of labels for electrical wires, adding comments to architect plans.

Description	Colour	Pack quantity	Min. order quantity	Article Number	EAN Code
① INKZALL [™] fine tip pens (4 pc) - black	Black	4	1	48223164	045242479818
② INKZALL [™] fine tip pens (4 pc) - coloured	Black, Red, Blue	4	1	48223165	045242479825



FASTBACK™ flip utility knife

- One handed blade opening. User can flip open the blade with one hand for easy activation.
- Integrated gut hook. Allows users to make cuts without exposing the blade.
- Tool free blade change. Less down time in the field for blade changes.
- Wire stripper. Eliminates the need to look for another tool in user's bag.
- Thin body design. Tool is easily stored in user's pocket.
- Belt clip for easy storage.



Description	Pack quantity	Min. order quantity	Article Number	EAN Code
① FASTBACK™ compact flip utility knife	1	1	4932471356	4058546289843
② FASTBACK™ flip utility knife	1	6	4932471357	4058546289850
③ FASTBACK™ flip utility knife with blade storage	1	1	4932471358	4058546289867

FASTBACK™ 5 in 1 folding knife

NEW

- Press and flip mechanism provides an easy, one-handed opening.
- Stainless steel blade.
- Liner lock secures the blade in the open position.
- Partially serrated for versatility making it easier to both pierce and tear through material.
- The folding knife includes a fold-out 1/4" bit holder along with a reversible PH2 and slotted bit.
- Built-in bottle opener for added functionality.
- Durable belt clip that reduces pocket tearing.
- Tether-ready lanyard hole.



Description	Pack quantity	Min. order quantity	Article Number	EAN Code
FASTBACK™ 5 in 1 folding knife	1	1	4932492454	4058546418212

FASTBACK™ 6 in 1 utility knife

- 1/4" Hex bit holder with double ended PH2 and SL5.5.
- One handed blade opening. User can flip open the blade with one hand for easy activation.
- Tool free blade change. Less down time in the field for blade changes.
- Wire stripper. Eliminates the need to look for another tool in user's bag.
- Belt clip for easy storage.
- Integrated bottle opener.



Description	Pack quantity	Min. order quantity	Article Number	EAN Code
FASTBACK™ 6 in 1 utility knife	1	1	4932478559	4058546347529

FASTBACK™ folding knife

NEW

- Press and flip operation permits one-handed opening.
- Resharpenable stainless steel blade.
- Piercing tip allows controlled piercing and smooth cutting.
- Liner lock secures the blade in the open position.
- Lanyard hole.
- Wire form belt clip for quick access without fraying pockets.

Description	Pack quantity	Min. order quantity	Article Number	EAN Code
① FASTBACK™ folding knife	1	1	48221990	045242296842
② FASTBACK™ Camo folding knife	1	1	4932492375	4058546417420



Compact pocket knife

- Compact size for carrying in the pocket.
- Resharpenable stainless steel blade.
- Piercing tip allows controlled piercing and smooth cutting.
- Liner lock secures the blade in the open position.
- Lanyard hole.



Description	Pack quantity	Min. order quantity	Article Number	EAN Code
Compact pocket knife	1	1	4932478560	4058546347536

Fixed blade knife

- The fixed blade knife is designed for optimal edge retention and durability.
- 4" (101mm) stainless steel blade, optimised to stay sharper longer.
- Full metal tang provides durability for tough cut.
- Ergonomic handle offers secure and comfortable grip.
- Lanyard hole for easy tethering.
- Durable moulded sheath with belt clip for fast access.



Description	Pack quantity	Min. order quantity	Article Number	EAN Code
Fixed blade knife	1	1	4932464828	4058546227739

Hawkbill fixed blade knife

- The hawkbill fixed blade knife is ideal for stripping wire and cable.
- Stainless steel blade is optimised to stay sharper longer.
- Full metal tang provides durability for tough cuts.
- Large ergonomic handle designed for comfortable use with gloves.
- Lanyard hole for easy tethering.
- Durable molded sheath with belt clip for fast access.



Description	Pack quantity	Min. order quantity	Article Number	EAN Code
Hawkbill fixed blade knife	1	1	4932464829	4058546227746

HARDLINE™ folding knives

NEW

- Premium D2 blade steel provides better corrosion resistance. High strength and wear resistance, stays sharp longer.
- Smooth / serrated blade and piercing tip. Ideal for tearing through material and tip allows controlled piercing.
- Flip opening with bearing system: can be opened with 1 hand only.
- Opening steel frame lock secures the blade in the open position.
- Glass filled nylon handle with stainless steel.
- Liner lock secures the blade in the open position.
- Lanyard hole.
- Reversible belt clip allows right or left handed carry.



Description	Blade type	Pack quantity	Min. order quantity	Article Number	EAN Code
① HARDLINE™ folding knife 75mm - smooth	Smooth	1	1	48221994	045242477043
② HARDLINE™ folding knife 75mm - serrated	Serrated	1	1	48221998	045242359165
③ HARDLINE™ folding knife 64mm - smooth	Smooth	1	1	4932492452	4058546418199
④ HARDLINE™ folding knife 89mm - smooth	Smooth	1	1	4932492453	4058546418205

HARDLINE™ fixed blade knife

- 5" (127 mm) AUS-8 Steel blade allows the blade to hold its edge longer, reducing the user's need to sharpen.
- Full metal tang provides durability for tough cuts.
- Overmolded handle for a strong secure grip, and a lanyard hole.
- Durable multi position sheath for flexible carry option and fast access.



Description	Pack quantity	Min. order quantity	Article Number	EAN Code
HARDLINE™ fixed blade knife	1	1	4932464830	4058546227753

Fixed blade utility knife

- Ready to use fixed blade for an easier and fastest access to the knife.
- Tool-free blade change: Saves time changing blades. Thumb-screw mechanism allows to change the blade quickly and without any extra tools.
- Blade storage holds up to 5 blades conveniently inside the handle.
- Tool lanyard hole for easy tethering.
- Heavy Duty: Durable full metal body.

Description	Pack quantity	Min. order quantity	Article Number	EAN Code
Fixed blade utility knife	1	1	4932471361	4058546289898



Sliding utility knife

- Side blade activation: Reduces the risk of exposing the blade accidentally. Tool free blade change: Saves time changing blades.
- Blade storage: Magnetic holder for 5 blades.
- Heavy Duty: Full metal body with rubber overmould for increased comfort and reduced hand slippage.

Description	Pack quantity	Min. order quantity	Article Number	EAN Code
① Sliding utility knife	1	6	4932471359	4058546289874
② Compact Sliding Utility Knife	1	1	4932478561	4058546347543



Self-retracting safety knife

- Self-retract mechanism: Retracts blade when the button is released. Blade storage holds up to 5 blades conveniently inside the handle.
- Tool-free blade change: Saves time changing blades. Thumb-screw mechanism allows to change the blade quickly and without any extra tools.
- Heavy Duty: Durable full metal body.

Description	Pack quantity	Min. order quantity	Article Number	EAN Code
Self-retracting safety knife	1	1	4932471360	4058546289881



General purpose utility blades

- Iron carbide deposited metal for longer lifetime.
- Optimised cutting angle geometry for sharpness.
- Extra ground cutting edge for cleaner cuts.
- Blades are protected and easily accessible from storage box.

Description	Total length (mm)	Height (mm)	Pack quantity	Min. order quantity	Article Number	EAN Code
① General purpose utility knife blades	62	19	50	1	48221950	045242344444
			5	1	48221905	045242268061
② Hook utility knife blades	62	19	50	1	48221952	045242286980
③ Carton utility knife blades (rounded)	62	19	5	1	48221934	045242286942



Snap knives

- Metal lock* for maximum durability and longer lifetime.
- Lock with a speed thread* that allows faster blade adjustment.
- Auto-lock slide** for faster blade adjustment.
- Snap-off cap pocket clip** snaps off blade segments.
- Overmolded handle offers a slip resistant grip and is an acetone resistant.
- Iron carbide blade for longer lifetime, increased sharpness and clean cut finish.

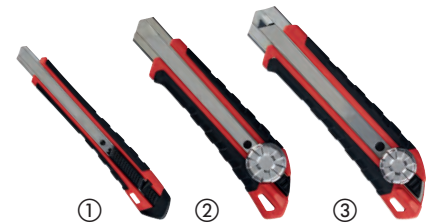

Description	Blade width (mm)	No. blade points	Pack quantity	Min. order quantity	Article Number	EAN Code
① Snap knife 9 mm	9	13	1	1	48221960	045242296811
② Snap knife 18 mm	18	8	1	1	48221961	045242296798
③ Snap knife 25 mm	25	7	1	1	48221962	045242296828

Snap blades

- Robust re-usable storage dispenser with easy access to blades.
- Optimized cutting angle geometry for sharpness and improved cutting precision.
- Iron carbide metal for longer life.
- Precise ground cutting edges for cleaner cuts.

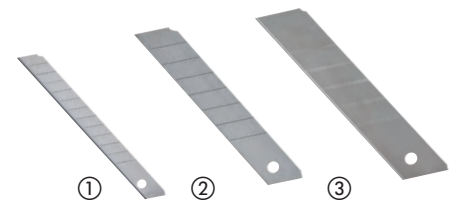

Description	Blade width (mm)	No. blade points	Pack quantity	Min. order quantity	Article Number	EAN Code
① Snap blades 9 mm	9	13	10	1	4932480106	4058546403911
② Snap blades 18 mm	18	8	10	1	4932480107	4058546403928
③ Snap blades 25 mm	25	7	10	1	4932480108	4058546403935

PVC saw

- All-metal handle design for best-in-class durability.
- Tool free blade change: up to 10x faster blade change.
- Overmold handle for increased comfort.
- Compact design.



Description	Pack quantity	Min. order quantity	Article Number	EAN Code
PVC saw	1	1	48220212	045242467518
PVC saw replacement blade	1	1	48220222	045242467532

Compact hacksaw

- Tool free blade change for changing blades up to 10x faster.
- Compact design, ideal for versatile cutting in tight spaces.
- Adjustable blade length for easier flush cutting.
- Rubber overmold grip for increased comfort.
- Accepts 12" blades.
- Supplied with 10" / 24 Tpi blade.



Description	Pack quantity	Min. order quantity	Article Number	EAN Code
Compact hacksaw	1	1	48220012	045242204571

Folding job saw

- Tool free blade change: Change blades up to 10x faster.
- Folding blade: Easier and safer storage.
- Rubber overmold grip: Increased comfort.
- Accepts all Sawzall® blades for increased versatility.
- Supplied with 18 TPI, 150 mm blade.



Description	Blade length (mm)	Pack quantity	Min. order quantity	Article Number	EAN Code
Folding job saw	150	1	1	48220305	045242204618

Hacksaw

- Tough metal frame, supports higher tension (25,000 PSI / 250 lbs).
- Overmould handle ensures secure grip and user comfort.
- Internal blade storage for extra blades.
- Supplied with 12" / 24 Tpi blade.



Description	Pack quantity	Min. order quantity	Article Number	EAN Code
Hacksaw	1	1	48220050	045242362226

Rasping jab saw

- 150 mm plaster / drywall blade: Extra strong thicker blade making it more resistant for plunge cuts.
- Coated for corrosion protection.
- Built in rasping holes: Allows user to rapidly expand holes or smooth rough edges.



Description	Pack quantity	Min. order quantity	Article Number	EAN Code
Rasping jab saw	1	1	4932479783	4058546375775

Jobsite scissors

- Iron carbide cutting edge for maximum durability. Longer lifetime vs. stainless steel.
- Chrome plated blades for maximum rust protection.
- All metal core: Full metal handle construction to protect from drops and handle breakage.
- Bolt lock technology protects blades from loosening to ensure precise cutting.
- Large handle loops for use with gloves.
- Index finger groove for more comfort.
- Laser edged ruler markings on the blade allows to measure and cut in one go.
- Jobsite offset scissors with micro-serrated blades for maximum durability and better grip.
- Jobsite offset scissors with 60°-offset head allows to keep hand above cutting material.



Description	Total length (mm)	Blade length (mm)	Weight (g)	Pack quantity	Min. order quantity	Article Number	EAN Code
① Straight scissors	230	95	180	1	1	4932479409	4058546372033
② Offset scissors	240	115	230	1	1	4932479410	4058546372040

Electricians Scissors

- Cable cutting groove for greater leverage.
- Rounded groove allows for easy wire stripping.
- Cable crimper for crimps up to 6 mm.
- Adjustable tightening screw allows to set desired resistance.
- Tool holder with belt strap for easy storage.



Description	Pack quantity	Min. order quantity	Article Number	EAN Code
Electricians Scissors	1	1	4932478620	4058546348137

Metal Aviation Snips

- Thumb and forefinger slots for increased comfort and less fatigue. Allows user to push through sheet metal with ease with less risk of cutting oneself.
- Serrated cutting edges prevent slippage when cutting.
- Less hand fatigue when cutting thicker materials. Design with compound leverage action.
- Torsion spring opens jaws automatically during cutting for faster cutting action and less fatigue work.
- Chrome plated rust protected forged blades for increased lifetime. Extra hardened to 65 HRC.
- Made from forged alloy steel for best durability – Cr Steel.
- One hand locking mechanism.
- Flush slimline design for non-snagging in material.
- Triple cutting direction identification – on the head, handle and by colour coded handle.
- Ergonomic and durable overmoulded grips add comfort and last longer.
- Aviation snips: For short, straight and shaped cuts. Ideal for narrow radius cuts and notch cuts.
- Offset snips: For long continuous straight or curved cuts. 45° offset keeps users hand away from the cutting material.
- Extra long aviation snips: For longer and straighter cuts in one go.

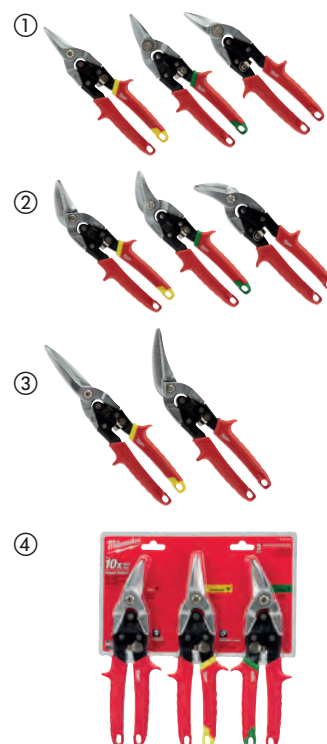

Cutting direction	Total length (mm)	Edge length (mm)	Max. cutting capacity aluminium (mm)	Max. cutting capacity stainless steel (mm)	Weight (g)	Pack quantity	Min. order quantity	Article Number	EAN Code
① Aviation snips: For short, straight and shaped cuts. Ideal for narrow radius cuts and notch cuts.									
Straight (yellow)	260	31	1.0	0.6	430	1	1	48224530	045242503643
Right (green)	260	31	1.0	0.6	430	1	1	48224520	045242503636
Left (red)	260	31	1.0	0.6	430	1	1	48224510	045242503629
② Offset snips: For long continuous straight or curved cuts. 45° offset keeps users hand away from the cutting material.									
Straight (yellow)	260	37	1.0	0.6	430	1	1	48224532	045242503674
Right (green)	260	30	1.0	0.6	430	1	1	48224522	045242503667
Left (red)	260	30	1.0	0.6	430	1	1	48224512	045242503650
③ Extra long aviation snips: For longer and straighter cuts in one go.									
Straight (yellow)	310	76	1.0	0.6	450	1	1	48224537	045242503681
Left (offset)	290	63	1.0	0.6	450	1	1	48224538	045242503698
④ Metal snips set (3pc) 48224510, 48224530 and 48224520									
						3	1	48224533	045242503735

Mini copper tubing cutters

- Proprietary adjustment mechanism.
- Chrome rollers for added durability and extended performance provide best in class rust protection.
- Easy grip knob allows faster adjustment and easier one handed use.
- Compact design to cut pipes in restricted areas.



Description	Max. cutting capacity in copper pipe (mm)	Pack quantity	Min. order quantity	Article Number	EAN Code
Mini copper tubing cutter 15 mm	3 - 15	1	1	48229250	045242521210
Mini copper tubing cutter 22 mm	3 - 22	1	1	48229258	045242521258
Mini copper tubing cutter 28 mm	3 - 28	1	1	48229251	045242521227



Constant swing copper tubing cutters

- Constant swing copper tubing cutters are engineered for straighter, cleaner cuts.
- 4 roller design delivers accurate cuts and prevents walking.
- Chrome rollers for added durability and extended performance provide best in class rust protection.
- Smooth adjustment mechanism.
- On-board reamer enables fast, easy deburring.
- A spare wheel is integrated in the knob.



Description	Max. cutting capacity in copper pipe (mm)	Pack quantity	Min. order quantity	Article Number	EAN Code
Constant swing copper tubing cutter 28 mm	3 - 28	1	1	48229259	045242521265
Constant swing copper tubing cutter 42 mm	3 - 42	1	1	48229252	045242521234
Constant swing copper tubing cutter 67 mm	16 - 67	1	1	48229253	045242521241
Reaming blades		3	1	48224257	045242356263



Tubing cutter blades

- Replacement blades for tubing cutters.

Description	Pack quantity	Min. order quantity	Article Number	EAN Code
Tubing cutter blades for copper	2	1	48224256	045242356256
Tubing cutter blades for stainless steel	4	1	4932464511	4058546224561



Reaming pen

- Provides easy deburring of copper tubing and PVC.
- All-metal design for durability through demanding jobsite use.
- Heat treated and black oxide coated blade for extended life.
- A slide resistant clip allows easy storage in the users pocket or tool bag for quick access.

Description	Pack quantity	Min. order quantity	Article Number	EAN Code
Reaming pen	1	1	48224255	045242356249



Plastic cutter

- Cuts PEX, PB, MDP, PE, plastic electrical conduits, pneumatic pipe, plastic overflow pipe, rubber hoses, silicon hoses up to Ø 25 mm.
- V-shaped blade allows quick and straight cuts; prevents crushing of material.
- Replaceable stainless steel blade.
- Robust construction: Metal core from the head to the handles for maximum lifetime.
- One handed locking mechanism, tool remains closed while in pouch, spring loaded but easy opening.
- Corrosion resistant head.



Description	Max. capacity tube & pipe Ø (mm)	Pack quantity	Min. order quantity	Article Number	EAN Code
Plastic Cutter	25	1	1	4932479407	4058546372019
Plastic cutter blade replacement	-	1	1	4932479408	4058546372026



Ratcheting PVC cutter

- Durable stainless steel rust proof blade for more cuts.
- Comfortable handle adds working comfort.
- Quick blade release adds working speed.
- One-handed metal lock.
- Lanyard hole, improves working security.
- Blades are replaceable.
- Suitable for: PVC, CPVC, PEX, PP, PB, PVDF, PE.



	Description	Max. capacity tube & pipe Ø (mm)	Pack quantity	Min. order quantity	Article Number	EAN Code
①	Ratcheting PVC cutter 42 mm	42	1	1	4932464172	4058546221171
	Ratcheting PVC cutter 60 mm	63	1	1	4932464173	4058546221188
②	Ratcheting PVC cutter blade 42 mm		1	1	48224211	045242477012
	Ratcheting PVC cutter blade 60 mm		1	1	48224216	045242477036



Cable cutter

- Best-in-class cut quality: Bevelled jaw heads for accurate, smooth cable shearing.
- Comfort grips: More comfortable than dipped plastic. Grips will not peel.
- Forged design: Tool durability in abusive environments.
- Rust protection: Black oxide finish protects from rust.



Description	Pack quantity	Min. order quantity	Article Number	EAN Code
Cable cutter	1	1	48226104	045242356140



Bolt cutters

- Forged steel blades for strong and durable cutting edge.
- Comfort grip handles will not peel or slide off.
- Blade adjustment screw ensures high performance and longer life.
- Lanyard holes.



Description]	Blade width (mm)	Cutting capacity for HRC 31 materials (Max. Ø mm)	Cutting capacity for HRC 48 materials (Max. Ø mm)]	Pack quantity	Min. order quantity	Article Number	EAN Code
14" bolt cutter	13	8	5	1	1	4932464827	4058546227722
24" bolt cutter	13	11	8	1	1	4932464826	4058546227715

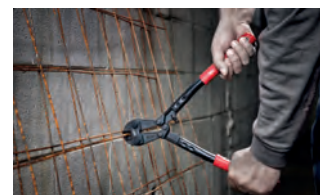

Extendable bolt cutters

- POWERMOVE[™] handles extend for easier cuts in tough applications.
- Forged steel blades for strong and durable cutting edge.
- Pivoting head for angle adjustment.
- Comfort grip handles will not peel or slide off.
- Lanyard holes.



Description	Blade width (mm)	Cutting capacity for HRC 31 materials (Max. Ø mm)	Cutting capacity for HRC 48 materials (Max. Ø mm)	Pack quantity	Min. order quantity	Article Number	EAN Code
14" / 18" extendable bolt cutter	13	8	5	1	1	4932464850	4058546227951
24" / 30" extendable bolt cutter	13	11	8	1	1	4932464851	4058546227968



Nail Puller

- Dimpler allows for easy nail removal with limited damage to surface.
- Low profile claw to reach the tightest of nails.
- Handle grip greatly reduces vibration.



Description	Length (cm)	Pack quantity	Min. order quantity	Article Number	EAN Code
9" nail puller	22.86	1	1	4932478249	4058546344269
10" nail puller	25.40	1	1	4932478250	4058546344276
12" nail puller	30.48	1	1	4932478251	4058546344283



Trim Puller

- Low profile trim claw to easily slide between trim/ skirting boards and walls.
- Dimpler allows for easy nail removal with limited damage to surface.
- Handle grip greatly reduces vibration.



Description	Length (cm)	Pack quantity	Min. order quantity	Article Number	EAN Code
10" trim puller	25.40	1	1	4932478252	4058546344290



Wrecking Bar

- Beveled edge improves leverage and accessibility when pulling nails, lifting or prying.
- Nail/ staple puller easily removes nails and staples without damaging flooring or surrounding materials.
- Reinforced strikable tongue for extra material penetration using a hammer.



Description	Length (cm)	Pack quantity	Min. order quantity	Article Number	EAN Code
12" wrecking bar	30.48	1	1	4932478253	4058546344306
15" wrecking bar	38.1	1	1	4932478254	4058546344313



Steel RIP claw hammer

- Shockshield grip reduces peak vibration.
- Straight/RIP claw for prying and demolition work.
- Magnetic nail starter for safer application.
- Side nail puller.
- I-Beam handle construction resists bending in prying applications.
- Precise balance for better handling.



Description	Pack quantity	Min. order quantity	Article Number	EAN Code
16oz Steel RIP claw hammer	1	1	4932478653	4058546348465
20oz Steel RIP claw hammer	1	1	4932478654	4058546348472

Steel curved claw hammer

- Shockshield grip reduces peak vibration.
- Curved claw hammer reduces damage when pulling nails.
- Magnetic nail starter for safer application.
- Side nail puller.
- I-Beam handle construction resists bending in prying applications.
- Precise balance for better handling.



Description	Pack quantity	Min. order quantity	Article Number	EAN Code
16oz Steel curved claw hammer	1	1	4932478655	4058546348489
20oz Steel curved claw hammer	1	1	4932478656	4058546348496

Fiberglass curved claw hammer

- Reinforced fiberglass handle
- Over moulded handle for increased grip and reduced vibration
- Curved claw hammer reduces damage when pulling nails
- Magnetic nail starter for safer application
- Precise balance for better handling

Description	Pack quantity	Min. order quantity	Article Number	EAN Code
16oz Fiberglass curved claw hammer	1	1	4932478657	4058546348502
20oz Fiberglass curved claw hammer	1	1	4932478658	4058546348519



Hickory curved claw hammer

- Hickory handle providing low vibration
- Curved claw hammer reduces damage when pulling nails
- Magnetic nail starter for safer application
- Precise balance for better handling

Description	Pack quantity	Min. order quantity	Article Number	EAN Code
16oz Hickory curved claw hammer	1	1	4932478659	4058546348526
20oz Hickory curved claw hammer	1	1	4932478660	4058546348533



Fiberglass engineers hammer

- Reinforced fiberglass handle
- Over moulded handle for increased grip and reduced vibration
- Reinforced head connection for added durability
- Precise balance for better handling
- DIN 1041

Description	Pack quantity	Min. order quantity	Article Number	EAN Code
200g Fiberglass engineers hammer	1	1	4932478661	4058546348540
300g Fiberglass engineers hammer	1	1	4932478662	4058546348557
500g Fiberglass engineers hammer	1	1	4932478663	4058546348564
800g Fiberglass engineers hammer	1	1	4932478664	4058546348571
1000g Fiberglass engineers hammer	1	1	4932478665	4058546348588



Hickory engineers hammer

- Hickory handle providing low vibration
- Reinforced head connection for added durability
- Precise balance for better handling
- DIN 1041

Description	Pack quantity	Min. order quantity	Article Number	EAN Code
200g Hickory engineers hammer	1	1	4932478666	4058546348595
300g Hickory engineers hammer	1	1	4932478667	4058546348601
500g Hickory engineers hammer	1	1	4932478668	4058546348618
800g Hickory engineers hammer	1	1	4932478669	4058546348625
1000g Hickory engineers hammer	1	1	4932478670	4058546348632



Club hammer

- **Duel Face Versatility:** Milled face provides additional grip and minimizes movement of face when striking chisels or large nails, the smooth face prevents damage to struck objects.
- **Reinforced Overstrike Protection:** Increases durability in the most common failure point.
- **Fiberglass handle with over molded grip:** Provides durability with improved grip capacity and comfort.
- **Lanyard Hole:** Easily comply with safety regulations working at height.



Description	Pack quantity	Min. order quantity	Article Number	EAN Code
1.36 kg / 3 lbs club hammer	1	1	4932478255	4058546344320

Steel ball peen hammer

NEW

- **SHOCKSHIELD™ grip** reduces peak vibration
- **Precise balance** for better handling and control
- **I-Beam handle construction** resists bending
- **Strong steel head** prevents chipping on contact
- **Durable grip handle** with an anti-slip design



Description	Weight (g)	Weight (oz)	Pack quantity	Min. order quantity	Article Number	EAN Code
450g Ball peen hammer	450	16	1	1	4932492346	4058546417130
680g Ball peen hammer	680	24	1	1	4932492347	4058546417147

Dead blow ball peen hammer

NEW

- **Precision balanced design** and steel shot-filled head for optimized control
- **Durable metal faces** preventing chipping on contact
- **Steel reinforced handle** for higher durability
- **Over molded handle** for more control and better grip



Description	Weight (g)	Weight (oz)	Pack quantity	Min. order quantity	Article Number	EAN Code
450g Dead blow ball peen hammer	450	16	1	1	4932492348	4058546417154
907g Dead blow ball peen hammer	907	32	1	1	4932492349	4058546417161

Dead blow hammer

NEW

- **Steel shot-filled head** for increased rebound reduction and maximised impact
- **High-performance cover** preventing damage to surfaces
- **Precision balanced design** and over molded handle for more control and better grip
- **Steel reinforced handle** for higher durability



Description	Weight (g)	Weight (oz)	Pack quantity	Min. order quantity	Article Number	EAN Code
790g Dead blow hammer	790	28	1	1	4932492350	4058546417178
1360g Dead blow hammer	1360	48	1	1	4932492351	4058546417185

Beveled Edge Chisel

NEW

- All metal core for maximum durability
- Metal striking cap for a longer handle life
- Permanent size markings on the blade and handle for quick identification
- Blade storage for safe transportation or storage



Description	Pack quantity	Min. order quantity	Article Number	EAN Code
Beveled Edge Chisel 6mm	1	1	4932479892	4058546376864
Beveled Edge Chisel 12mm	1	1	4932479893	4058546376871
Beveled Edge Chisel 19mm	1	1	4932479894	4058546376888
Beveled Edge Chisel 25mm	1	1	4932479895	4058546376895
Beveled Edge Chisel 32mm	1	1	4932479896	4058546376901
Beveled Edge Chisel Set 4pc	4	1	4932479897	4058546376918

Hex Keys

- Twist and lock case for easy access to keys.
- Ball end for up to 30° access to screw.
- Size identification to easily identify the key.
- Lanyard hole for easy attachment to the MILWAUKEE[®] lanyard range allowing use at height.



Description	Pack quantity	Min. order quantity	Article Number	EAN Code
Hex Keys 1.5, 2, 2.5, 3, 4, 5, 6, 8, 10mm	9	1	4932478621	4058546348144

Folding hex key set

NEW

- Foldable keys enable easy access & storage solution
- High contrast size callouts for quick and easy identification
- Ergonomically handle provides comfortable and secure grip
- Metal housing for increased durability



Description	Pack quantity	Min. order quantity	Article Number	EAN Code
8pc Metric folding hex key set	1	1	4932480978	4058546412630

Folding Torx key set

NEW

- Foldable keys enable easy access & storage solution
- High contrast size callouts for quick and easy identification
- Ergonomically handle provides comfortable and secure grip
- Metal housing for increased durability





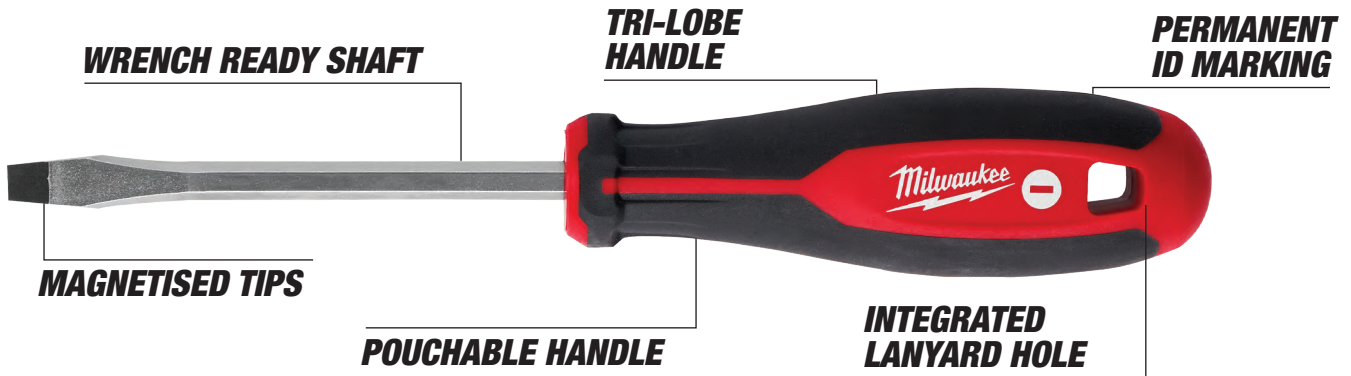

Description	Pack quantity	Min. order quantity	Article Number	EAN Code
8pc Folding Torx key set	1	1	4932480979	4058546412647

Tri-lobe screwdrivers

- Comfortable Tri-Lobe handle optimized for maximum user comfort and high torque applications.
- Permanent visible ID markings allows for quick tool identification.
- Landyard hole for easy attachment to a safety system.
- Hardened magnetic tips for maximum durability and fastener retention.
- Anti role, 3 sided collar on the handle
- Wrench ready shank allows extra leverage to be applied.



	Description	Shank type	Pack quantity	Min. order quantity	Article Number	EAN Code
	SL 0.4 x 2 x 65	Round	1	1	4932471773	4058546296728
	SL 0.4 x 2.5 x 75	Round	1	1	4932471774	4058546296735
	SL 0.5 x 3 x 75	Round	1	1	4932471775	4058546296742
	SL 0.5 x 3 x 150	Round	1	1	4932471776	4058546296759
	SL 0.6 x 3.5 x 100	Round	1	1	4932471777	4058546296766
	SL 0.8 x 4 x 100	Round	1	1	4932471778	4058546296773
	SL 1.0 x 5.5 x 125	Round	1	1	4932471779	4058546296780
	SL 1.2 x 6.5 x 45	Wrench ready	1	1	4932471780	4058546296797
	SL 1.2 x 6.5 x 125	Wrench ready	1	1	4932471781	4058546296803
	SL 1.2 x 8 x 150	Wrench ready	1	1	4932471782	4058546296810
SL 1.6 x 8 x 175	Wrench ready	1	1	4932471783	4058546296827	
SL 1.2 x 10 x 200	Wrench ready	1	1	4932471784	4058546296834	
	PH0 x 75	Wrench ready	1	1	4932471785	4058546296841
	PH1 x 100	Wrench ready	1	1	4932471786	4058546296858
	PH2 x 45	Wrench ready	1	1	4932471787	4058546296865
	PH2 x 125	Wrench ready	1	1	4932471788	4058546296872
	PH3 x 150	Wrench ready	1	1	4932471789	4058546296889
	PZ0 x 75	Wrench ready	1	1	4932471790	4058546296896
	PZ1 x 100	Wrench ready	1	1	4932471791	4058546296902
	PZ2 x 45	Wrench ready	1	1	4932471792	4058546296919
	PZ2 x 125	Wrench ready	1	1	4932471793	4058546296926
	PZ3 x 150	Wrench ready	1	1	4932471794	4058546296933
	T6 x 65	Round	1	1	4932471795	4058546296940
	T7 x 65	Round	1	1	4932471796	4058546296957
	T8 x 65	Round	1	1	4932471797	4058546296964
	T9 x 75	Round	1	1	4932471798	4058546296971
	T10 x 75	Round	1	1	4932471799	4058546296988
	T15 x 75	Round	1	1	4932471800	4058546296995
	T20 x 100	Round	1	1	4932471801	4058546297008
	T25 x 100	Round	1	1	4932471802	4058546297015
	T30 x 125	Round	1	1	4932471803	4058546297022
	T40 x 125	Round	1	1	4932471804	4058546297039



Description	Pack quantity	Min. order quantity	Article Number	EAN Code
① Tri-lobe screwdriver set 1 (6 pc) PZ1 / PZ2 / SL3 / SL4 / SL5.5 / SL6.5	6	1	4932471806	4058546297053
② Tri-lobe screwdriver set 2 (6 pc) PH1 / PH2 / SL3 / SL4 / SL5.5 / SL6.5	6	1	4932471807	4058546297060
Tri-lobe screwdriver set 3 (10 pc) ③ PZ1 / PZ2 / PH1 / PH2 / SL3 / SL5.5 / SL6.5 / SL6.5 / SL8	10	1	4932471808	4058546297077
Tri-lobe screwdriver set 4 (12 pc) ④ PZ0 / PZ1 / PZ2 / PH0 / PH1 / PH2 / SL2.5 / SL4 / SL5.5 / SL6.5 / SL6.5 / SL8	12	1	4932472003	4058546323998
⑤ Tri-lobe screwdriver Torx set (6 pc) T10 / T15 / T20 / T25 / T30 / T40	6	1	4932471809	4058546297084
⑥ Tri-lobe screwdriver stubby set (2 pc) PZ2 x 45mm / SL6.5 x 45mm	2	1	4932471810	4058546297091

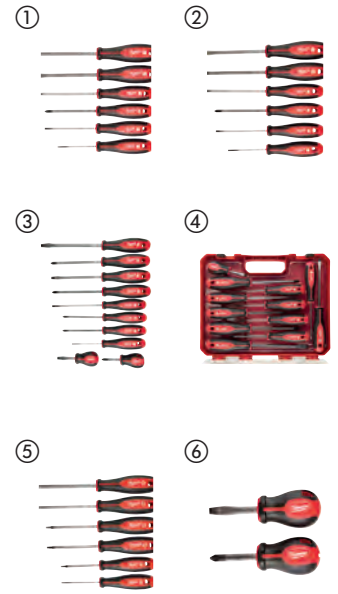

Tri-lobe demolition screwdriver

- Hammer ready strike caps.
- All metal core.
- Wrench ready shank.
- Comfortable Tri-Lobe handle.

Description	Pack quantity	Min. order quantity	Article Number	EAN Code
Tri-lobe demolition screwdriver set PH2 / SL7.9 mm	2	1	4932471872	4058546297718



Demolition driver

- Hardened all metal core giving maximum shank durability.
- Multiple striking caps to give user more force when prying and chiseling.

Description	Pack quantity	Min. order quantity	Article Number	EAN Code
Demo driver	1	1	4932480975	4058546412609



Precision screwdrivers

- All metal core for improved durability.
- 360° rotating back cap.
- Chrome plated shanks increase tool life by reducing corrosion.
- Durable case with robust zipper included to store tools.
- Longer shanks for improved visibility and extended reach.



Description	Pack quantity	Min. order quantity	Article Number	EAN Code
Precision screwdriver set (6 pc) PH00 / PH0, SL1.6 / SL2 / SL3.2 / SL4	6	1	4932471869	4058546297688
Torx precision screwdriver (6 pc) T6, T7, T8, T9, T10, T15	6	1	4932471870	4058546297695



8 in 1 compact ratcheting multi-bit screwdriver

- Full metal high torque ratchet for 2x driving speed and control.
- Chrome plated marine grade rust protected bits.
- Revolver style bit storage in handle.
- Precision hardened bit tips: Durable driving tips for secure fitment and long life.



Description	Pack quantity	Min. order quantity	Article Number	EAN Code
8 in 1 compact ratcheting multi-bit screwdriver PH1 / PH2 / PZ1 / PZ2 / T15 / SL4.8 / SL6.4	1	1	4932471868	4058546297671



9 in 1 ratcheting multi-bit screwdriver

- Ergonomic 152 mm long screwdriver with 1/4" Hex nut driver (in reception) and built in loop maker.
- Full metal high torque ratchet for 2x driving speed and control.
- 88 mm long power groove bits, power tool compatibility.
- Precision hardened bit tips: Durable driving tips for secure fitment and long life.
- Revolver style bit storage in handle.
- Chrome plated marine grade rust protected bits.



Description	Pack quantity	Min. order quantity	Article Number	EAN Code
9 in 1 ratchet multi-bit screwdriver - universal PH1 / PH2 / PZ1 / PZ2 / T15 / T20 / Slotted 0.8 x 5.5 mm	1	12	4932471598	4058546294977
9 in 1 ratchet multi-bit screwdriver - Hex Hex 1.5 mm / Hex 2 mm / Hex 2.5 mm / Hex 3 mm / Hex 4 mm / Hex 5 mm / Hex 6 mm	1	12	4932471599	4058546294984

HOLLOWCORE[™] magnetic nut drivers

- HOLLOWCORE[™] unlimited depth in long bolts and threaded rod applications (patent pending).
- Magnetic retention driver heads for secure fitment in fastening applications.
- Universal driver head fits 4x more fasteners - square, 12 point, 8 point, Hex.
- Removes rusted and stripped bolts.
- Colour coded ID markings allow for quick tool identification on jobsite.
- Wrench ready Hex shanks deliver additional leverage.
- Chrome plated for maximum durability.
- Forged steel shanks provide longer life and more durability.



Size (mm)	Colour code	For anchor thread size	Pack quantity	Min. order quantity	Article Number	EAN Code
① 5	Black	-	1	1	48222531	045242294428
② 5.5	Brown	M3	1	1	48222532	045242294435
③ 6	Red	M3.5	1	1	48222533	045242294442
④ 7	Orange	M4	1	1	48222534	045242294459
⑤ 8	Yellow	M5	1	1	48222535	045242294466
⑥ 10	Blue	M6	1	1	48222536	045242294473
⑦ 13	Orange	M8	1	1	48222537	045242294480



Tri-Lobe VDE screwdrivers

- VDE tested to 10, 000 V and guaranteed to 1,000 V.
- Slim shank diameter for access to low lying screw applications.
- Comfortable Tri-Lobe handle optimized for maximum user comfort and high torque applications.
- Permanent visible ID markings allows for quick tool identification.
- Anti role, 3 sided collar on the handle
- Landyard hole for easy attachment to a safety system.

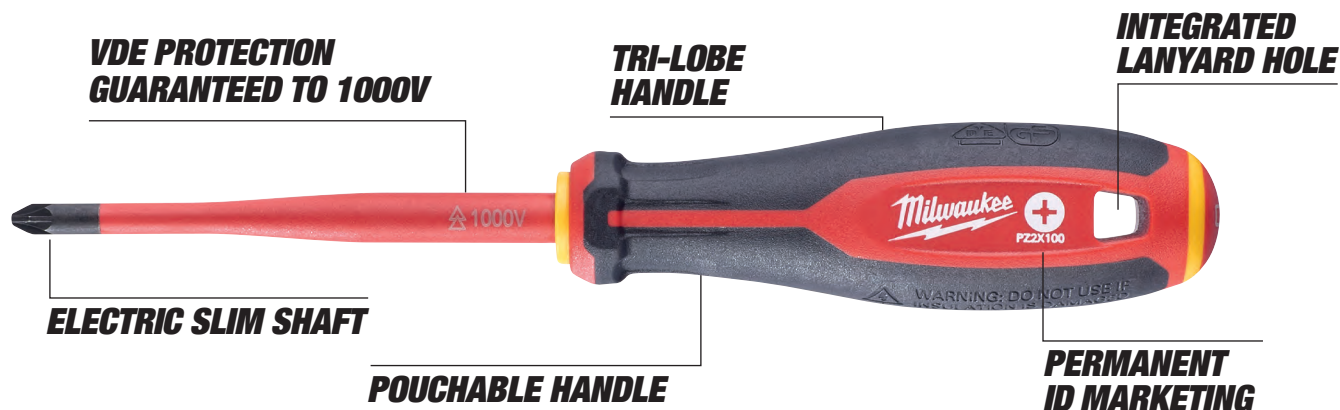

	Description	Pack quantity	Min. order quantity	Article Number	EAN Code
⊖	Tri-Lobe VDE screwdriver - slotted 0.4 x 2.5 x 75	1	1	4932478712	4058546349059
	Tri-Lobe VDE screwdriver - slotted 0.5 x 3 x 100	1	1	4932478713	4058546349066
	Tri-Lobe VDE screwdriver - slotted 0.6 x 3.5 x 100	1	1	4932478714	4058546349073
	Tri-Lobe VDE screwdriver - slotted 0.8 x 4 x 100	1	1	4932478715	4058546349080
	Tri-Lobe VDE screwdriver - slotted 1.0 x 5.5 x 125	1	1	4932478716	4058546349097
	Tri-Lobe VDE screwdriver - slotted 1.2 x 6.5 x 150	1	1	4932478717	4058546349103
	Tri-Lobe VDE screwdriver - slotted 1.6 x 8 x 175	1	1	4932478718	4058546349110
+	Tri-Lobe VDE screwdriver PH0 x60	1	1	4932478720	4058546349134
	Tri-Lobe VDE screwdriver PH1 x80	1	1	4932478721	4058546349141
	Tri-Lobe VDE screwdriver PH2 x100	1	1	4932478722	4058546349158
	Tri-Lobe VDE screwdriver PH3 x150	1	1	4932478723	4058546349165
	Tri-Lobe VDE screwdriver PZ0 x60	1	1	4932478724	4058546349172
	Tri-Lobe VDE screwdriver PZ1 x80	1	1	4932478725	4058546349189
	Tri-Lobe VDE screwdriver PZ2 x100	1	1	4932478726	4058546360085
⊕	Tri-Lobe VDE screwdriver PZ3 x150	1	1	4932478727	4058546360092
	Tri-Lobe VDE screwdriver T10 x60	1	1	4932478728	4058546360108
	Tri-Lobe VDE screwdriver T15 x75	1	1	4932478729	4058546360115
	Tri-Lobe VDE screwdriver T20 x100	1	1	4932478730	4058546360122
	Tri-Lobe VDE screwdriver T25 x100	1	1	4932478731	4058546360139
	Tri-Lobe VDE screwdriver T30 x100	1	1	4932478732	4058546360146
	Tri-Lobe VDE screwdriver PH/S L1 x80	1	1	4932478733	4058546360153
	Tri-Lobe VDE screwdriver PH/ SL2 x100	1	1	4932478734	4058546360160
	Tri-Lobe VDE screwdriver PZ/ SL1 x80	1	1	4932478735	4058546360177
	Tri-Lobe VDE screwdriver PZ/ SL2 x100	1	1	4932478736	4058546360184
	Voltage tester 0.5 x 3 x 65	1	1	4932478719	4058546349127
①	Tri-Lobe VDE screwdriver set - 5 pc PZ1 / PZ2 / SL3 / SL4 and voltage tester	1	1	4932478737	4058546360191
②	Tri-Lobe VDE screwdriver PZ set - 7 pc SL2.5 / SL3 / SL4, PH2, PZ1 / PZ2 and voltage tester	1	1	4932478738	4058546360207
③	Tri-Lobe VDE screwdriver PH set - 7 pc SL2.5 / SL3 / SL4 / SL5.5 / PH1 / PH2 and voltage tester	1	1	4932478739	4058546360214
④	Tri-Lobe VDE screwdriver 12 pc set SL2.5 / SL3 / SL4 / SL5.5 / PH1 / PH2 / PZ1 / PZ2 / T10 / T15 / T20 and voltage tester	1	1	4932479095	4058546368890



VDE pliers

- VDE (DIN EN/IEC 60900) certified tools. Tested to 10,000 volts and guaranteed to 1,000 volts. Tested against cold to -40°.
- Steel blades are fully forged, hardened and tempered for best durability. Grey titanium surface finish is non reflective and ensures maximum corrosion resistance.
- Induction hardened cutting edges to cut even the hardest of materials.
- Precision machined joint for maximum power transmission with optimum leverage for easy and effortless work.
- Ergonomic grip with softgrip for comfortable handling and good grip.



Description	Total length (mm)	Cutting capacity in very hard wire 2300N/mm ² (Max. Ø mm)	Cutting capacity in hard wire 1800N/mm ² (Max. Ø mm)	Cutting capacity in soft wire 220N/mm ² (Max. Ø mm)	Cutting capacity in cable Al and Cu (Max. Ø mm)	Capacity (mm)	Capacity pipe [Max.Weight (g) Ø mm]	Pack quantity	Min. order quantity	Article Number	EAN Code	
① VDE cable cutter	160	-	-	-	16	-	-	185	1	1	4932464562	4058546225070
	210	-	-	-	25	-	-	315	1	1	4932464563	4058546225087
② VDE long round nose plier	205	-	2.2	3.9	-	-	-	200	1	1	4932464564	4058546225094
③ VDE long 45 deg. round nose pliers	205	-	2.2	3.9	-	-	-	200	1	1	4932464565	4058546225100
④ VDE diagonal cutter	145	-	1.7	5	8	-	-	160	1	1	4932464566	4058546225117
	160	-	2	6	11	-	-	210	1	1	4932464567	4058546225124
	180	-	2.5	7	13	-	-	240	1	1	4932464568	4058546225131
⑤ VDE heavy duty diagonal cutter	180	2.2	2.6	7	13	-	-	250	1	1	4932464569	4058546225148
	200	2.5	2.8	8	15	-	-	305	1	1	4932464570	4058546225155
⑥ VDE combination plier	165	-	2	4	10	-	-	180	1	1	4932464571	4058546225162
	180	-	2.2	5.2	12	-	-	250	1	1	4932464572	4058546225179
⑦ VDE wire stripping plier	160	-	-	-	0.75MM ² - 6MM ²	-	-	180	1	1	4932464573	4058546225186
⑧ VDE water pump plier	240	-	-	-	-	50	50	395	1	1	4932464574	4058546225193
⑨ VDE plier set (3 pc) - Diagonal cutter (160 mm), long nose plier (205 mm), combi plier (180 mm)								660	3	1	4932464575	4058546225209

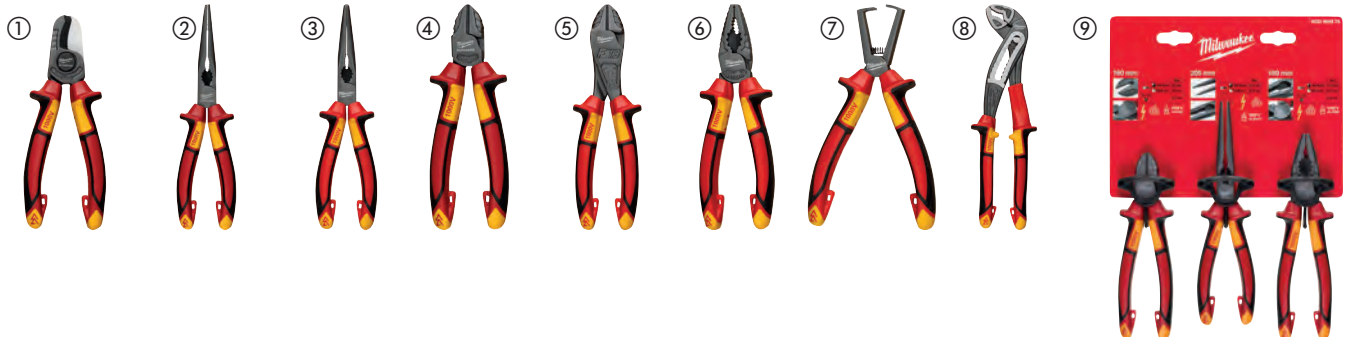

Nipping pliers

- Iron carbide edge: Longer blade life.
- Comfort grips: More comfortable than dipped plastic. Grips will not peel.
- Smooth head: Will not mark surface during pull / pry applications.
- Forged design: Tool durability in abusive environments.
- Rust protection: Black oxide finish protect from rust.



Description	Length (mm)	Pack quantity	Min. order quantity	Article Number	EAN Code
Nipping pliers	180	1	1	48226407	045242356096

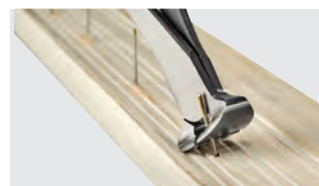

7 in 1 wire stripping pliers

- Wire stripper : Strips wire sizes 0.75 mm², 1.0 mm², 1.5 mm², 2.5 mm², 4.0 mm², 6.0 mm².
- Wire cutter: With curved laser hardened cutting edges.
- Plier suitable for gripping and bending cables.
- Reaming head for smoothing 12 - 25 mm pipe.
- Loop maker: Built in loop maker function for wire.
- Integrated crimper.
- Integrated bolt cutter.
- One-handed swing lock: Easy one-handed use and remains locked while in pouch. Spring loaded for easy opening.
- Rust protection increases tool life by reducing corrosion.



Description	Strip- ping capac- ities (mm ²)	Cutting capacity in hard wire 1800 N/mm ² (Max. Ø mm)	Cutting capac- ity in cable Al and Cu (Max. Ø mm)	De- burring head (Max. Ø mm)	Pack quantity	Min. order quantity	Article Number	EAN Code
7 in 1 combination plier	0.75, 1.0, 1.5, 2.5, 4.0, 6.0	2.5	6.0	25	1	1	4932478554	4058546347475



Heavy Duty Lineman's pliers

- For universal gripping, cutting applications.
- High leverage design: Long handles for maximum cutting power and leverage.
- Deburrer: Deburring ribs on head for up to 25 mm pipe. No need for extra tools.
- Nail puller: Powerful gripping and high leverage.
- Laser hardened durable cutting edges: Cuts wire, bolts, screws and nails. Extra hardened jaws to 64 HRC.
- Serrated gripping zone for strong gripping and pulling.
- Made from Chrome Vanadium steel for best durability and good rust protection.
- Ergonomic and durable overmoulded grips add comfort and last longer.
- With crimping facility.



Cut cap. in hard wire (mm)	Cutting capacity soft wire (mm)	Total length (mm)	Weight (g)	Deburring head (Max. Ø mm)	Pack quantity	Min. order quantity	Article Number	EAN Code
3.0	4.6	250	480	25	1	1	48226100	045242342228



Long nose pliers

- Long nose pliers: Specially suitable for gripping, bending and adjusting in restricted areas.
- Wire cutter: Cuts wires up to 2.5 mm.
- Deburrer: Deburring ribs on head for up to 20 mm pipe. No need for extra tools.
- Nail puller.
- Serrated jaws for better grip and excellent control.
- Laser hardened durable cutting edges. Extra hardened to 64 HRC.
- Made from Chrome Vanadium for best durability and good rust protection.
- Ergonomic and durable overmolded grips add comfort and last longer.



Total length (mm)	Cut cap. in hard wire (mm)	Cable diameter (mm)	Jaw length (mm)	Weight (g)	Deburring head (Max. Ø mm)	Pack quantity	Min. order quantity	Article Number	EAN Code
210	2.5	6.0	51	255	18	1	1	48226101	045242342211



Diagonal pliers

- For all around cutting use.
- Tip protection: Tips are off set ground to protect cutting edges from damage when dropped.
- High leverage design: Long handles for maximum cutting power and leverage.
- Deburrer: Deburring ribs on head for up to 25 mm pipe. No need for extra tools.
- 15° offset head allows flush cutting, can be used as a nail puller for easier and quicker prying and pulling.
- Laser hardened durable cutting edges. Extra hardened to 64 HRC. Cuts wire, bolts, screws and nails.
- Made from forged alloy Chrome Vanadium steel for best durability and good rust protection.
- Ergonomic and durable overmoulded grips add comfort and last longer.



	Total length (mm)	Cut cap. in hard wire (mm)	Cutting capacity soft wire (mm)	Jaw length (mm)	Weight (g)	Pack quantity	Min. order quantity	Article Number	EAN Code
①	160	2.5	4.0	22	195	1	1	48226106	045242342181
②	180	3.0	4.0	26	246	1	1	48226107	045242342198

Quick adjust water pump pliers

- For gripping, fastening and holding work pieces.
- One hand push button adjustment for fast and firm grip.
- Fine scale adjustment positions for precise grip. Less downtime and more efficiency.
- Self locking button for fast and firm adjustment.
- V-groove jaws with profile for firmer grip, more precise fit and reduced slipping. Special teeth hardening 60 HRC.
- Made from Nickel and Chrome forged alloy steel for best durability and good rust protection.
- Ergonomic and durable overmolded grips add comfort and last longer.
- Deburring head and handle design. No need for extra tools.
- Available in 3 lengths for optimum leverage.
- Ergonomic slim design to allow access in confined areas.



	Total length (mm)	Total length (inch)	Max. nut size AF (mm)	Max. capacity tube & pipe Ø (mm)	Weight (g)	Deburring head (Max. Ø mm)	Deburring handles (Max. Ø mm)	Pack quantity	Min. order quantity	Article Number	EAN Code
①	200	8	30	32	250	38	25	1	1	48226208	045242342235
②	250	10	36	42	425	51	25	1	1	48226210	045242342242
③	300	12	50	60	660	70	25	1	1	48226212	045242342259

PVC/Oil filter pliers

NEW

- Versatile 89mm jaw capacity in a compact 229mm size, offering a solution for multiple plumbing and automotive applications
- Comfort grips that will not peel
- Forged designs for rust protection and increased durability
- On-board reaming functionality



Description	Length (mm)	Pack quantity	Min. order quantity	Article Number	EAN Code
PVC/Oil filter pliers	65	1	1	4932492511	4058546418786

TORQUE LOCK[™] locking pliers

- TORQUE LOCK[™]: Faster set up and easy release when clamping flat and round material. Extra force can be applied to the TORQUE LOCK[™] screw for better and more secure grip. Can also be used for hanging / storage purposes.
- Hardened jaws: Better grip force on jobsite material.
- Rust protection: Chrome plated tool increases life by reducing corrosion.
- Lever release design: Traditional release lever for jobsite convenience.
- MAXBITE[™] pliers have special jaw geometry for maximum grip.

	Total length (mm)	Total length (inch)	Jaw type	Jaw capacity flat (mm)	Jaw opening capacity for pipe (mm)	Pack quantity	Min. order quantity	Article Number	EAN Code
①	170	7	MAXBITE [™]	-	38	1	1	4932471730	4058546296292
②	250	10	MAXBITE [™]	-	50	1	1	4932471729	4058546296285
③	127	5	curved	-	26	1	1	4932472263	4058546339098
④	170	7	curved	-	38	1	1	4932471732	4058546296315
⑤	250	10	curved	-	51	1	1	4932471725	4058546296247
⑥	250	10	flat	30	-	1	1	4932471726	4058546296254
⑦	100	4	flat long nose	42	-	1	1	4932472262	4058546339081
⑧	150	6	flat long nose	52	-	1	1	4932471731	4058546296308
⑨	230	9	flat long nose	76	-	1	1	4932471733	4058546296322

TORQUE LOCK[™]



TORQUE LOCK™ locking C clamps

- TORQUE LOCK™: Faster set up and easy release when clamping flat and round materials for welding. Extra force can be applied to the TORQUE LOCK™ screw for better and more secure grip. Can also be used for hanging / storage purposes.
- Hardened jaws: Better grip force on jobsite material.
- Rust protection: Chrome plated tool increases life by reducing corrosion.
- Lever release design: Traditional release lever for jobsite convenience.

	Total length (mm)	Total length (inch)	Jaw type	Jaw capacity flat (mm)	Pack quantity	Min. order quantity	Article Number	EAN Code
①	230	9	Deep reach regular pointed pads	114	1	1	4932472257	4058546339036
②	480	18	Deep reach regular pointed pads	170	1	1	4932472259	4058546339050
③	280	11	Regular pointed pads	90	1	1	4932471728	4058546296278
④	480	18	Regular pointed pads	170	1	1	4932472260	4058546339067
⑤	230	9	Deep reach swivel pads	114	1	1	4932472258	4058546339043
⑥	280	11	Swivel pads	100	1	1	4932471727	4058546296261
⑦	480	18	Swivel pads	170	1	1	4932472261	4058546339074

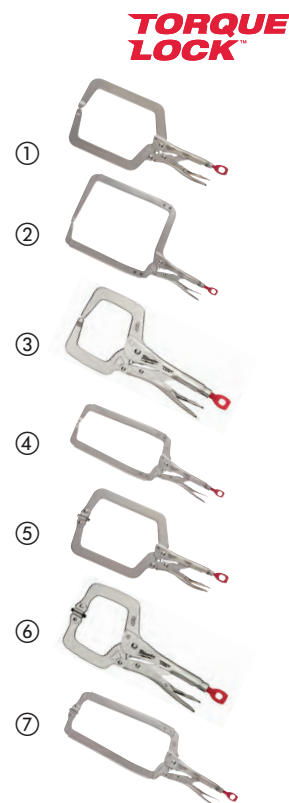

TORQUE LOCK™ seamer

- TORQUE LOCK™: Faster set up and easy release when clamping flat material. Extra force can be applied to the TORQUE LOCK™ screw for better and more secure grip. Can also be used for hanging / storage purposes.
- Hardened jaws: Better grip force on jobsite material.
- Rust protection: Chrome plated tool increases life by reducing corrosion.
- Lever release design: Traditional release lever for jobsite convenience.
- The seamer makes all kinds of bendings, forming, crimping tasks with ease.
- It is ideal for holding sheet metal parts.

Description	Total length (mm)	Total length (inch)	Jaw capacity flat (mm)	Pack quantity	Min. order quantity	Article Number	EAN Code
TORQUE LOCK™ seamer	200	8	42	1	1	4932471734	4058546296339



TORQUE LOCK™ chain wrench

- TORQUE LOCK™: Faster set up and easy release when clamping round material. Extra force can be applied to the TORQUE LOCK™ screw for better and more secure grip. Can also be used for hanging / storage purposes.
- Rust protection: Chrome plated tool increases life by reducing corrosion.
- Lever release design: Traditional release lever for jobsite convenience.
- Locking chain wrench holds and locks around any shape object.
- It adjusts quickly for ratchet action in either direction.

Description	Total length (mm)	Total length (inch)	Jaw opening capacity for pipe (mm)	Pack quantity	Min. order quantity	Article Number	EAN Code
TORQUE LOCK™ chain wrench	270	9	79	1	1	48223542	045242472727



Steel and aluminium pipe wrenches

- Overbite jaw for secure grip on pipes and fittings.
- Dual coil springs for maximum durability and tool life.
- Ergonomic handle for maximum comfort, won't dig into the palm.
- Hardened jaws for increased durability and better grip.
- Lanyard hole.



Description	Total length (mm)	Total length (inch)	Jaw opening capacity for pipe (mm)	Jaw opening capacity for pipe (inch)	Weight (g)	Pack quantity	Min. order quantity	Article Number	EAN Code
Aluminium pipe wrench 250 mm	250	10	38	1.5	598	1	1	48227210	045242342372
Aluminium pipe wrench 300 mm	300	12	51	2	816	1	1	48227212	045242342389
① Aluminium pipe wrench 350 mm	350	14	51	2	1076	1	1	48227214	045242342396
Aluminium pipe wrench 450 mm	450	18	63	2.5	1630	1	1	48227218	045242342419
Aluminium pipe wrench 600 mm	600	24	76	3	2644	1	1	48227224	045242342426
Steel pipe wrench 250 mm	250	10	38	1.5	916	1	1	48227110	045242342334
② Steel pipe wrench 300 mm	300	12	51	2	1270	1	1	48227112	045242342341
Steel pipe wrench 350 mm	350	14	51	2	1627	1	1	48227114	045242342358
Steel pipe wrench 450 mm	450	18	63	2.5	2531	1	1	48227118	045242342365

Cheater aluminium adjustable pipe wrench

- All in one adjustable sliding handle design between 450 mm & 600 mm.
- Removable handle to 250 mm length for access to tight spaces.
- Aluminium design for lighter weight.
- Overbite jaw for secure grip on pipes and fittings.
- Ergonomic round handle for maximum comfort, won't dig into the palm.
- Hardened jaws for increased durability and better grip.



Description	Total length (inch)	Jaw opening capacity for pipe (mm)	Jaw opening capacity for pipe (inch)	Weight (g)	Pack quantity	Min. order quantity	Article Number	EAN Code
Cheater aluminium adjustable pipe wrench	10 / 18 / 24	63	2.5	2019	1	1	4932478672	4058546348656

CHEATER - adaptable pipe wrench

- 3 handle design - 10"/ 250 mm mode for tight spaces, 18"/ 450 mm mode for general purpose, 24"/ 600 mm mode for maximum leverage and reach.
- Overbite jaw for secure grip on pipes and fittings.
- Dual coil springs for maximum durability and tool life.
- Ergonomic handle for maximum comfort, won't dig into the palm.
- Ergonomic hook jaw design - for easy detachment from the workpiece.
- Hardened jaws for increased durability and better grip.
- Lanyard hole.

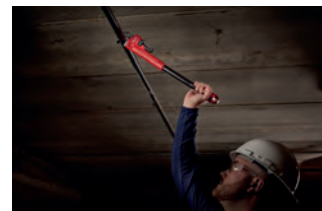

Description	Total length (mm)	Total length (inch)	Jaw opening capacity for pipe (mm)	Jaw opening capacity for pipe (inch)	Weight (g)	Pack quantity	Min. order quantity	Article Number	EAN Code
Adaptable pipe wrench	250/450/600	10/18/24	63	2.5	3243	1	1	48227314	045242342402

Adjustable wrenches

- Precision adjustment screw with accurate threads and tight tolerances. The jaws won't back off during use.
- Chrome plating for best-in-class rust protection and increased durability.
- Ergonomic rounded handle design for a comfortable fit in the hand and less pressure points on the palm.
- Slim head design for reaching into tight spaces.
- Parallel jaws won't slip or damage finish surfaces.
- Permanent lasered inch and mm markings for accurate adjustment.
- 8" adjustable wrench (48227508) has an extra wide jaw of 38 mm for increased jaw capacity in confined environments.
- Lanyard hole.



Total length (mm)	Total length (inch)	Jaw opening capacity for pipe (mm)	Jaw thickness (mm)	Tip thickness (mm)	Weight (g)	Pack quantity	Min. order quantity	Article Number	EAN Code
150	6	24.5	11.5	7,7	186	1	1	48227406	045242356225
200	8	30	14	8,7	353	1	1	48227408	045242356218
200	8	40	14	8,1	385	1	1	48227508	045242356232
250	10	36.5	16	9,9	535	1	1	48227410	045242356201
300	12	42.5	17	10,8	748	1	1	48227412	045242356195
380	15	46	22	13,5	1,470	1	1	48227415	045242356188
150 mm (48227406) + 250 mm (48227410)						2	1	48227400	045242358823

Basin wrench

- Ratchet-compatible design: Accepts 3/8" ratchet.
- Hi-leverage design: Achieve break-away torque on stuck fasteners.
- Door-knob handle: More comfortable than square.
- Easy to adjust handle: Best-in-class adjustability.



Description	Jaw size (mm)	Pack quantity	Min. order quantity	Article Number	EAN Code
Basin wrench compact	10 - 32	1	1	48227001	045242366170
Basin wrench	32 - 65	1	1	48227002	045242366187

S Jaw pipe wrench

- Made of forged chrome vanadium steel and oil hardened for durability according to DIN 5234.
- Slim, S shaped 45° angled jaws for best reach in confined areas.
- Assymetric serrated induction hardened jaws for maximum grip.
- I-Beam handle design for maximum strength.



Total length (mm)	Capacity pipe [Max. Ø mm]	Weight (g)	Pack quantity	Min. order quantity	Article Number	EAN Code
340	52	965	1	1	4932464576	4058546225216
450	67	1570	1	1	4932464577	4058546225223
550	83	3000	1	1	4932464578	4058546225230

Fish tape

- High flexibility tape for easier feeding.
- Thicker tape for better pushing.
- Triple strand design, won't kink.
- Low friction case for smooth pay out.
- Square inner grip for easier winding.

Description	Length (m)	Pack quantity	Min. order quantity	Article Number	EAN Code
① Steel fish tape 7.5 m	7.5	1	1	4932472120	4058546325169
① Steel fish tape 15 m	15	1	1	4932472121	4058546325176
② Polyester fish tape 15 m	15	1	1	4932472118	4058546325145
② Polyester fish tape 30 m	30	1	1	4932472119	4058546325152



MAX BITE™ COMBINATION SPANNER RANGE

25%
MORE TORQUE
*VS STANDARD SPANNERS

Consisting of three different spanner ranges, MAX BITE™ combination spanners, MAX BITE™ ratcheting combination spanners and MAX BITE™ flex head ratcheting combination spanners. All our MAX BITE™ spanners are engineered to deliver high performance in tight spaces and our range allows users to work with all nut and bolt sizes for any job.

Our MAX BITE™ spanner range features 2.5° of arc swing, a slim profile and a MAX BITE™ open end that enables the mechanic to work with the highest efficiency in restricted areas. For superior comfort and durability, our combination spanners feature a thin, rounded I-beam handle, double stacked pawls and ink-filled size labels for easy identification and readability from multiple angles. The MAX BITE™ spanners chrome finish allows easy cleaning and sustains the high-quality, premium aesthetic.



**12-POINT
BOX END**



**144 TOOTH
COUNT - 2.5°
OF ARC SWING**



**ROUNDED
I-BEAM
HANDLE**

**INK-FILLED
SIZE LABELS**

**CHROME
FINISH**

MAX BITE[™] combination spanner

- MAX BITE[™] open-end grip reduces rounding and stripping.
- Rounded I-Beam handle for comfortable handling grip.
- Ink-filled labels for better visibility.
- 15° offset box for better accessibility.



Description	Total length (mm)	Pack quantity	Min. order quantity	Article Number	EAN Code
6 mm MAX BITE [™] combination spanner	128	1	1	4932480197	4058546404826
7 mm MAX BITE [™] combination spanner	135	1	1	4932480198	4058546404833
8 mm MAX BITE [™] combination spanner	140	1	1	4932471516	4058546294151
9 mm MAX BITE [™] combination spanner	150	1	1	4932471517	4058546294168
10 mm MAX BITE [™] combination spanner	158	1	1	4932471518	4058546294175
11 mm MAX BITE [™] combination spanner	165	1	1	4932471519	4058546294182
12 mm MAX BITE [™] combination spanner	172	1	1	4932471520	4058546294199
13 mm MAX BITE [™] combination spanner	180	1	1	4932471521	4058546294205
14 mm MAX BITE [™] combination spanner	190	1	1	4932471522	4058546294212
15 mm MAX BITE [™] combination spanner	200	1	1	4932471523	4058546294229
16 mm MAX BITE [™] combination spanner	210	1	1	4932471524	4058546294236
17 mm MAX BITE [™] combination spanner	225	1	1	4932471525	4058546294243
18 mm MAX BITE [™] combination spanner	235	1	1	4932471526	4058546294250
19 mm MAX BITE [™] combination spanner	250	1	1	4932471527	4058546294267
20 mm MAX BITE [™] combination spanner	262	1	1	4932471528	4058546294274
21 mm MAX BITE [™] combination spanner	272	1	1	4932471529	4058546294281
22 mm MAX BITE [™] combination spanner	295	1	1	4932471530	4058546294298
23 mm MAX BITE [™] combination spanner	310	1	1	4932480199	4058546404840
24 mm MAX BITE [™] combination spanner	315	1	1	4932480200	4058546404857
25 mm MAX BITE [™] combination spanner	340	1	1	4932480201	4058546404864
26 mm MAX BITE [™] combination spanner	340	1	1	4932480202	4058546404871
27 mm MAX BITE [™] combination spanner	367	1	1	4932480203	4058546404888
28 mm MAX BITE [™] combination spanner	367	1	1	4932480204	4058546404895
29 mm MAX BITE [™] combination spanner	393	1	1	4932480205	4058546404901
30 mm MAX BITE [™] combination spanner	393	1	1	4932480206	4058546404918
32 mm MAX BITE [™] combination spanner	429	1	1	4932480207	4058546404925
36 mm MAX BITE [™] combination spanner	513	1	1	4932480208	4058546404932

MAX BITE[™] combination spanner sets

- MAX BITE[™] open-end grip reduces rounding and stripping.
- Rounded I-Beam handle for comfortable handling grip.
- Optimised storage: 7 pc set with carry handle, 15 pc set in tray for easy storage and connection to tool roller cabinet drawers.
- Ink-filled labels for clear visibility.
- 15° offset box for better accessibility.
- Chrome alloy steel, chrome plated.

Description	Pack quantity	Min. order quantity	Article Number	EAN Code
MAX BITE[™] metric combination spanner set (7 pc)				
① 8, 10, 12, 13, 14, 15, 17 mm	7	1	4932464257	4058546222024
MAX BITE[™] metric combination spanner set (15 pc)				
② 8, 9, 10, 11, 12, 13, 14, 15, 16, 17, 18, 19, 20, 21, 22 mm	15	1	4932464258	4058546222031
MAX BITE[™] imperial combination spanner set (7 pc)				
③ 3/8" 7/16" 1/2" 9/16" 5/8" 11/16" 3/4"	7	1	48229407	045242499038
MAX BITE[™] imperial combination spanner set (15 pc)				
④ 1/4" 9/32" 5/16" 11/32" 3/8" 7/16" 1/2" 9/16" 5/8" 11/16" 3/4" 13/16" 7/8" 15/16" 1"	15	1	48229415	045242499021



MAX BITE™ ratcheting combination spanner

- 144 Ratcheting teeth positions giving 2.5° arc swing allowing access in tighter spaces.
- Durable double stacked pawls for longer ratchet life.
- MAX BITE™ open-end grip reduces rounding and stripping.
- Rounded I-Beam handle for comfortable handling grip.
- Ink-filled labels for better visibility.
- Chrome alloy steel, chrome plated.



Description	Total length (mm)	Pack quantity	Min. order quantity	Article Number	EAN Code
6 mm MAX BITE™ ratcheting combination spanner	134	1	1	4932480209	4058546404949
7 mm MAX BITE™ ratcheting combination spanner	142	1	1	4932480210	4058546404956
8 mm MAX BITE™ ratcheting combination spanner	146	1	1	4932471501	4058546294007
9 mm MAX BITE™ ratcheting combination spanner	156	1	1	4932471502	4058546294014
10 mm MAX BITE™ ratcheting combination spanner	165	1	1	4932471503	4058546294021
11 mm MAX BITE™ ratcheting combination spanner	172	1	1	4932471504	4058546294038
12 mm MAX BITE™ ratcheting combination spanner	179	1	1	4932471505	4058546294045
13 mm MAX BITE™ ratcheting combination spanner	187	1	1	4932471506	4058546294052
14 mm MAX BITE™ ratcheting combination spanner	198	1	1	4932471507	4058546294069
15 mm MAX BITE™ ratcheting combination spanner	208	1	1	4932471508	4058546294076
16 mm MAX BITE™ ratcheting combination spanner	218	1	1	4932471509	4058546294083
17 mm MAX BITE™ ratcheting combination spanner	234	1	1	4932471510	4058546294090
18 mm MAX BITE™ ratcheting combination spanner	243	1	1	4932471511	4058546294106
19 mm MAX BITE™ ratcheting combination spanner	258	1	1	4932471512	4058546294113
20 mm MAX BITE™ ratcheting combination spanner	272	1	1	4932471513	4058546294120
21 mm MAX BITE™ ratcheting combination spanner	282	1	1	4932471514	4058546294137
22 mm MAX BITE™ ratcheting combination spanner	303	1	1	4932471515	4058546294144
24 mm MAX BITE™ ratcheting combination spanner	320	1	1	4932480211	4058546404963
25 mm MAX BITE™ ratcheting combination spanner	341	1	1	4932480212	4058546404970
27 mm MAX BITE™ ratcheting combination spanner	367	1	1	4932480213	4058546404987
30 mm MAX BITE™ ratcheting combination spanner	393	1	1	4932480214	4058546404994
32 mm MAX BITE™ ratcheting combination spanner	429	1	1	4932480215	4058546405007

MAX BITE™ ratcheting combination spanner sets

- 144 Ratcheting teeth positions giving 2.5° arc swing allowing access in tighter spaces.
- Durable double stacked pawls for long-lasting ratchet life.
- MAX BITE™ open-end grip reduces rounding and stripping.
- Ink-filled labels for clear visibility.
- Chrome alloy steel, chrome plated.
- Rounded I-Beam handle for comfortable handling grip.

Description	Pack quantity	Min. order quantity	Article Number	EAN Code
① MAX BITE™ ratcheting metric combination spanner set (7 pc) 8, 10, 12, 13, 14, 15, 17 mm	7	1	4932464993	4058546229382
② MAX BITE™ ratcheting metric combination spanner set (15 pc) 8, 9, 10, 11, 12, 13, 14, 15, 16, 17, 18, 19, 20, 21, 22 mm	15	1	4932464994	4058546229399



MAX BITE[™] flexible head ratcheting combination spanner

NEW

- 180° pivoting head for greater access to tight spaces.
- MAX BITE[™] open-end grip reduces rounding and stripping.
- 144 ratcheting teeth positions giving 2.5° arc swing allowing access in tighter spaces.
- Durable double stacked pawls for longer ratchet life.
- Rounded I-Beam handle for comfortable handling grip.
- Ink-filled labels for better visibility.
- Chrome alloy steel, chrome plated.



Description	Total length (mm)	Pack quantity	Min. order quantity	Article Number	EAN Code
8 mm MAX BITE [™] flexible head ratcheting combination spanner	146	1	1	4932480181	4058546404666
9 mm MAX BITE [™] flexible head ratcheting combination spanner	156	1	1	4932480182	4058546404673
10 mm MAX BITE [™] flexible head ratcheting combination spanner	165	1	1	4932480183	4058546404680
11 mm MAX BITE [™] flexible head ratcheting combination spanner	172	1	1	4932480184	4058546404697
12 mm MAX BITE [™] flexible head ratcheting combination spanner	179	1	1	4932480185	4058546404703
13 mm MAX BITE [™] flexible head ratcheting combination spanner	187	1	1	4932480186	4058546404710
14 mm MAX BITE [™] flexible head ratcheting combination spanner	198	1	1	4932480187	4058546404727
15 mm MAX BITE [™] flexible head ratcheting combination spanner	208	1	1	4932480188	4058546404734
16 mm MAX BITE [™] flexible head ratcheting combination spanner	218	1	1	4932480189	4058546404741
17 mm MAX BITE [™] flexible head ratcheting combination spanner	233	1	1	4932480190	4058546404758
18 mm MAX BITE [™] flexible head ratcheting combination spanner	243	1	1	4932480191	4058546404765
19 mm MAX BITE [™] flexible head ratcheting combination spanner	256	1	1	4932480192	4058546404772
20 mm MAX BITE [™] flexible head ratcheting combination spanner	272	1	1	4932480193	4058546404789
21 mm MAX BITE [™] flexible head ratcheting combination spanner	282	1	1	4932480194	4058546404796
22 mm MAX BITE [™] flexible head ratcheting combination spanner	303	1	1	4932480195	4058546404802

MAX BITE[™] flexible head ratcheting combination spanner set

- 180° pivoting head for greater access to tight spaces.
- MAX BITE[™] open-end grip reduces rounding and stripping.
- 144 ratcheting teeth positions giving 2.5° arc swing allowing access in tighter spaces.
- Durable double stacked pawls for longer ratchet life.
- Rounded I-Beam handle for comfortable handling grip.
- Ink-filled labels for better visibility.
- Chrome alloy steel, chrome plated.

Description	Pack quantity	Min. order quantity	Article Number	EAN Code
① MAX BITE [™] metric flexible head ratcheting combination spanner set (7 pc) 8, 10, 12, 13, 14, 15, 17 mm	7	1	4932478557	4058546347505
② MAX BITE [™] metric flexible head ratcheting combination spanner set (15 pc) 8, 9, 10, 11, 12, 13, 14, 15, 16, 17, 18, 19, 20, 21, 22 mm	15	1	4932478558	4058546347512

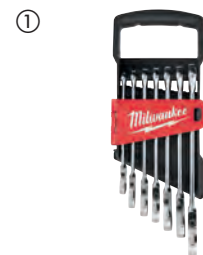

Ratchets

- 90 tooth design with 4 degrees of arc swing for tight work spaces.
- Slim profile head with flush direction lever offers better accessibility.

Description	Length (mm)	Pack quantity	Min. order quantity	Article Number	EAN Code
① 1/4" drive compact ratchet	76	1	1	4932479646	4058546374402
② 1/4" drive ratchet	152	1	1	48229014	045242513017
③ 1/4" drive long ratchet	229	1	1	4932479647	4058546374419
3/8" drive compact ratchet	127	1	1	4932479650	4058546374440
3/8" drive ratchet	216	1	1	48229038	045242513024
3/8" drive long ratchet	305	1	1	4932479651	4058546374457
1/2" drive ratchet	286	1	1	4932471865	4058546297640
1/2" drive long ratchet	457	1	1	4932479654	4058546374488



Flex Head Ratchets

- 90 tooth design with 4 °of arc swing for tight work spaces.
- Versatile lockable flex head: Switch between 7 locking positions and freely moving head.
- Slim profile head with flush direction lever offers better accessibility.
- Standard and extended handle lengths for easier access in tight spaces or extra leverage.

Description	Length (mm)	Pack quantity	Min. order quantity	Article Number	EAN Code
① 1/4" drive flexible head ratchet	140	1	1	4932479648	4058546374426
② 1/4" drive long flexible head ratchet	229	1	1	4932479649	4058546374433
3/8" drive flexible head ratchet	216	1	1	4932479652	4058546374464
3/8" drive long flexible head ratchet	305	1	1	4932479653	4058546374471
1/2" drive flexible head ratchet	286	1	1	4932479655	4058546374495
1/2" drive long flexible head ratchet	457	1	1	4932479656	4058546374501



1/2" drive breaker bar

- Provides Extra leverage for tougher bolts.
- 180° swiveling head.

Description	Total length (mm)	Total length (inch)	Article Number	EAN Code
1/2" drive breaker drive (15')	380	15	4932471866	4058546297657
1/2" drive breaker drive (24')	610	24	4932471867	4058546297664



1/4" drive chrome sockets

- FOUR FLAT[™] sides on socket deter rolling.
- Wrench ready FOUR FLAT[™] sides.
- Stamped sizes for easy visibility.
- Chrome finish.



Description	Width (mm)	Diameter (mm)	Length (mm)	Pack quantity	Min. order quantity	Article Number	EAN Code
1/4" drive - 4 mm	9.7	6.8	25	1	1	4932479992	4058546377861
1/4" drive - 4.5 mm	9.7	7.2	25	1	1	4932479993	4058546377878
1/4" drive - 5 mm	9.5	8	25	1	1	4932478312	4058546345037
1/4" drive - 5.5 mm	9.5	8.6	25	1	1	4932478313	4058546345044
1/4" drive - 6 mm	9.5	9.5	25	1	1	4932478314	4058546345051
1/4" drive - 7 mm	9.5	10.7	25	1	1	4932478315	4058546345068
1/4" drive - 8 mm	9.5	11.8	25	1	1	4932478316	4058546345075
1/4" drive - 9 mm	11.1	12.8	25	1	1	4932478317	4058546345082
1/4" drive - 10 mm	11.1	14.5	25	1	1	4932478318	4058546345099
1/4" drive - 11 mm	12.7	15.8	25	1	1	4932478319	4058546345105
1/4" drive - 12 mm	14	16.8	25	1	1	4932478320	4058546345112
1/4" drive - 13 mm	14.3	17.8	25	1	1	4932478321	4058546345129
1/4" drive - 14 mm	15.9	19.8	25	1	1	4932478322	4058546345136
1/4" drive - 15 mm	16	20.8	25	1	1	4932478323	4058546345143
1/4" deep drive - 4 mm	9.7	7.2	50	1	1	4932479994	4058546377885
1/4" deep drive - 4.5 mm	9.7	20.8	50	1	1	4932479995	4058546377892
1/4" drive deep - 5 mm	9.3	8	50	1	1	4932478324	4058546345150
1/4" drive deep - 5.5 mm	9.3	8.6	50	1	1	4932478325	4058546345167
1/4" drive deep - 6 mm	9.3	9.8	50	1	1	4932478326	4058546345174
1/4" drive deep - 7 mm	9.3	10.8	50	1	1	4932478327	4058546345181
1/4" drive deep - 8 mm	9.3	11.8	50	1	1	4932478328	4058546345198
1/4" drive deep - 9 mm	10.8	12.8	50	1	1	4932478329	4058546345204
1/4" drive deep - 10 mm	10.8	14.8	50	1	1	4932478330	4058546345211
1/4" drive deep - 11 mm	12.4	15.8	50	1	1	4932478331	4058546345228
1/4" drive deep - 12 mm	13.7	16.8	50	1	1	4932478332	4058546345235
1/4" drive deep - 13 mm	14	17.8	50	1	1	4932478333	4058546345242
1/4" drive deep - 14 mm	15.6	19.8	50	1	1	4932478334	4058546345259
1/4" drive deep - 15 mm	15.6	20.8	50	1	1	4932478335	4058546345266

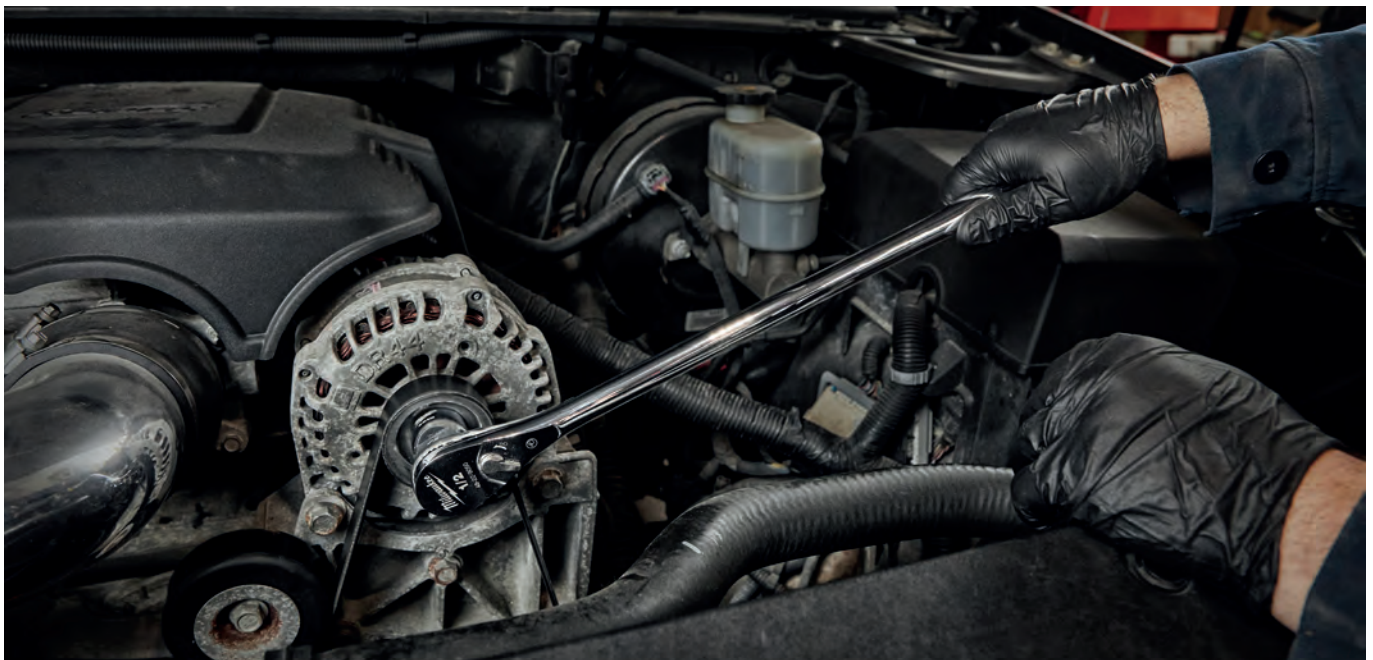

3/8" drive chrome sockets

- FOUR FLAT™ sides on socket deter rolling.
- Wrench ready FOUR FLAT™ sides.
- Stamped sizes for easy visibility.
- Chrome finish.



Description	Width (mm)	Diameter (mm)	Length (mm)	Pack quantity	Min. order quantity	Article Number	EAN Code
3/8" drive - 6 mm	14.3	10.3	28	1	1	4932478336	4058546345273
3/8" drive - 7 mm	14.3	10.9	28	1	1	4932478337	4058546345280
3/8" drive - 8 mm	14.3	12	28	1	1	4932478338	4058546345297
3/8" drive - 9 mm	14.3	13.3	28	1	1	4932478339	4058546345303
3/8" drive - 10 mm	14.3	14.8	28	1	1	4932478340	4058546345310
3/8" drive - 11 mm	14.3	16.3	28	1	1	4932478341	4058546345327
3/8" drive - 12 mm	14.3	17.8	28	1	1	4932478342	4058546345334
3/8" drive - 13 mm	15.9	18.3	28	1	1	4932478343	4058546345341
3/8" drive - 14 mm	15.9	19.8	28	1	1	4932478344	4058546345358
3/8" drive - 15 mm	17	21.3	28	1	1	4932478345	4058546345365
3/8" drive - 16 mm	17.5	22	28	1	1	4932478346	4058546345372
3/8" drive - 17 mm	19	23.8	28	1	1	4932478347	4058546345389
3/8" drive - 18 mm	20	24.3	28	1	1	4932478348	4058546345396
3/8" drive - 19 mm	20	25.8	28	1	1	4932478349	4058546345402
3/8" drive - 20 mm	22.7	27.8	30	1	1	4932479996	4058546377908
3/8" drive - 21 mm	22.7	27.8	30	1	1	4932479997	4058546377915
3/8" drive - 22 mm	23.7	29.8	30	1	1	4932479998	4058546377922
3/8" drive - 23 mm	26.7	31.8	30	1	1	4932479999	4058546377939
3/8" drive - 24 mm	26.7	31.8	30	1	1	4932480000	4058546377946
3/8" drive deep - 6 mm	14	10.3	63	1	1	4932478350	4058546345419
3/8" drive deep - 7 mm	14	10.9	63	1	1	4932478351	4058546345426
3/8" drive deep - 8 mm	14	12	63	1	1	4932478352	4058546345433
3/8" drive deep - 9 mm	14	13.3	63	1	1	4932478353	4058546345440
3/8" drive deep - 10 mm	14	14.5	63	1	1	4932478354	4058546345457
3/8" drive deep - 11 mm	14	16.8	63	1	1	4932478355	4058546345464
3/8" drive deep - 12 mm	14	17.3	63	1	1	4932478356	4058546345471
3/8" drive deep - 13 mm	16	18.8	63	1	1	4932478357	4058546345488
3/8" drive deep - 14 mm	17	19.8	63	1	1	4932478358	4058546345495
3/8" drive deep - 15 mm	18	21.3	63	1	1	4932478359	4058546345501
3/8" drive deep - 16 mm	19	21.8	63	1	1	4932478360	4058546345518
3/8" drive deep - 17 mm	21	23.8	63	1	1	4932478361	4058546345525
3/8" drive deep - 18 mm	21	24.3	63	1	1	4932478362	4058546345532
3/8" drive deep - 19 mm	22	25.8	63	1	1	4932478363	4058546345549
3/8" deep drive - 20 mm	22.7	27.8	63	1	1	4932480001	4058546377953
3/8" deep drive - 21 mm	22.7	27.8	63	1	1	4932480002	4058546377960
3/8" deep drive - 22 mm	23.7	29.8	63	1	1	4932480003	4058546377977
3/8" deep drive - 23 mm	26.7	31.8	63	1	1	4932480004	4058546377984
3/8" deep drive - 24 mm	26.7	31.8	63	1	1	4932480005	4058546377991

3/8" Drive Chrome Socket Set

NEW

- FOUR FLAT[™] sides on socket deter rolling
- Wrench ready FOUR FLAT[™] sides
- Stamped sizes for easy visibility
- Chrome finish for easy cleaning and corrosion protection
- Stored on a socket rail for tool organization

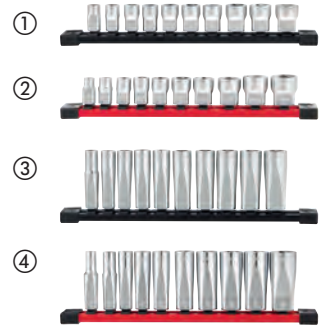

Description	Height (mm)	Length (mm)	Pack quantity	Min. order quantity	Article Number	EAN Code
① 3/8" Drive 10PC Metric Chrome Sockets	44	273	10	1	4932492507	4058546418748
② 3/8" Drive 10PC Imperial Chrome Sockets	44	273	10	1	4932492508	4058546418755
③ 3/8" Drive 10 PC Metric Deep Chrome Sockets	77	273	10	1	4932492509	4058546418762
④ 3/8" Drive 10PC Imperial Deep Chrome Socket Set	77	273	10	1	4932492510	4058546418779



3/8" Drive Spark Plug Socket

NEW

- Magnetic or rubber holding prevents wear down and enables secure hold
- Stamped sizes for quick and easy identification
- Knurling area for better finger grip
- Pin hole to enable securing of socket



Description	Length (mm)	Diameter (mm)	Pack quantity	Min. order quantity	Article Number	EAN Code
3/8" Drive 9/16" Spark Plug Socket	68	14.29	1	1	4932480674	4058546409593
3/8" Drive 14mm Spark Plug Socket	68	14	1	1	4932480679	4058546409647
3/8" Drive 16mm Spark Plug Socket	68	16	1	1	4932480676	4058546409616
3/8" Drive 16mm Magnetic Spark Plug Socket	68	16	1	1	4932480675	4058546409609
3/8" Drive 18mm Spark Plug Socket	68	18	1	1	4932480680	4058546409654
3/8" Drive 20.8mm Spark Plug Socket	68	20.8	1	1	4932480677	4058546409623
3/8" Drive 20.8mm Magnetic Spark Plug Socket	68	20.8	1	1	4932480678	4058546409630



1/2" drive chrome sockets

- FOUR FLAT™ sides on socket deter rolling.
- Wrench ready FOUR FLAT™ sides.
- Stamped sizes for easy visibility.
- Chrome finish.



Description	Width (mm)	Diameter (mm)	Length (mm)	Pack quantity	Min. order quantity	Article Number	EAN Code
1/2" drive - 8 mm	17.7	13.7	38	1	1	4932480006	4058546378004
1/2" drive - 9 mm	17.7	14.2	38	1	1	4932480007	4058546378011
1/2" drive - 10 mm	18.8	15.3	38	1	1	4932480008	4058546378028
1/2" drive - 11 mm	18.8	16.8	38	1	1	4932480009	4058546378035
1/2" drive - 12 mm	18.8	17.8	38	1	1	4932480010	4058546378042
1/2" drive - 13 mm	18.8	19	38	1	1	4932480011	4058546378059
1/2" drive - 14 mm	18.8	20.3	38	1	1	4932480012	4058546378066
1/2" drive - 15 mm	18.8	21.8	38	1	1	4932480013	4058546378073
1/2" drive - 16 mm	18.8	21.8	38	1	1	4932480014	4058546378080
1/2" drive - 17 mm	19.4	23.8	38	1	1	4932480015	4058546378097
1/2" drive - 18 mm	20.5	25.8	38	1	1	4932480016	4058546378103
1/2" drive - 19 mm	20.5	25.8	38	1	1	4932480017	4058546378110
1/2" drive - 20 mm	22.1	27.8	38	1	1	4932480018	4058546378127
1/2" drive - 21 mm	22.1	27.8	38	1	1	4932480019	4058546378134
1/2" drive - 22 mm	23.3	29.8	38	1	1	4932480020	4058546378141
1/2" drive - 23 mm	25.3	31.8	39	1	1	4932480021	4058546378158
1/2" drive - 24 mm	25.3	31.8	39	1	1	4932480022	4058546378165
1/2" drive - 25 mm	27.7	33.8	42	1	1	4932480023	4058546378172
1/2" drive - 26 mm	27.7	33.8	42	1	1	4932480024	4058546378189
1/2" drive - 27 mm	29.7	35.8	42	1	1	4932480025	4058546378196
1/2" drive - 28 mm	29.7	37.8	42	1	1	4932480026	4058546378202
1/2" drive - 30 mm	32.7	39.8	44	1	1	4932480027	4058546378219
1/2" drive - 32 mm	33.8	41.8	44	1	1	4932480028	4058546378226
1/2" drive - 36 mm	37.8	45.8	48	1	1	4932480029	4058546378233
1/2" drive deep - 10 mm	18.8	15	78	1	1	4932480030	4058546378240
1/2" drive deep - 11 mm	18.8	16.8	78	1	1	4932480031	4058546378257
1/2" drive deep - 12 mm	18.8	17.8	78	1	1	4932480032	4058546378264
1/2" drive deep - 13 mm	18.8	19	78	1	1	4932480033	4058546420550
1/2" drive deep - 14 mm	18.8	20.3	78	1	1	4932480034	4058546376048
1/2" drive deep - 15 mm	18.8	21.8	78	1	1	4932480035	4058546376055
1/2" drive deep - 16 mm	18.8	21.8	78	1	1	4932480036	4058546376062
1/2" drive deep - 17 mm	19.4	23.8	78	1	1	4932480037	4058546376079
1/2" drive deep - 18 mm	20.5	25.8	78	1	1	4932480038	4058546376086
1/2" drive deep - 19 mm	20.5	25.8	78	1	1	4932480039	4058546376093
1/2" drive deep - 20 mm	22.7	27.8	78	1	1	4932480040	4058546376109
1/2" drive deep - 21 mm	22.7	27.8	78	1	1	4932480041	4058546376116
1/2" drive deep - 22 mm	23.7	29.8	78	1	1	4932480042	4058546403270
1/2" drive deep - 23 mm	26.7	31.8	78	1	1	4932480043	4058546403287
1/2" drive deep - 24 mm	26.7	31.8	78	1	1	4932480044	4058546403294
1/2" drive deep - 27 mm	29.7	35.8	78	1	1	4932480045	4058546403300
1/2" drive deep - 30 mm	32.7	39.8	78	1	1	4932480046	4058546403317
1/2" drive deep - 32 mm	33.8	41.8	78	1	1	4932480047	4058546403324
1/2" drive deep - 36 mm	37.8	45.8	78	1	1	4932480048	4058546403331

Ratchet and socket sets

- 90 tooth design with 4 °of arc swing for tight work spaces.
- Comes with a removable inner tray perfectly designed to be stored.
- Sockets are stamped with measurements on the flat side for easy-to-read visibility.
- All metal design for maximum durability.
- FOUR FLAT[™] sides on socket deter rolling.
- Slim profile head with flush direction lever offers better accessibility.



Description	Pack quantity	Min. order quantity	Article Number	EAN Code
① Metric 1/4" ratchet + socket set (28 pc) Standard sockets: 5 mm, 5.5 mm, 6 mm, 7 mm, 8 mm, 9 mm, 10 mm, 11 mm, 12 mm, 13 mm, 14 mm, 15 mm / Deep well sockets: 5 mm, 5.5 mm, 6 mm, 7 mm, 8 mm, 9 mm, 10 mm, 11 mm, 12 mm, 13 mm, 14 mm, 15 mm / 76 mm extension, 152 mm extension, Universal Joint	28	1	4932464943	4058546228880
② Metric & imperial 1/4" ratchet + socket set (50 pc) Standard sockets: 5/32", 3/16", 7/32", 1/4", 9/32", 5/16", 11/32", 3/8", 7/16", 1/2", 9/16", 5 mm, 5.5 mm, 6 mm, 7 mm, 8 mm, 9 mm, 10 mm, 11 mm, 12 mm, 13 mm, 14 mm, 15 mm / Deep well socket: 5/32", 3/16", 7/32", 1/4", 9/32", 5/16", 11/32", 3/8", 7/16", 1/2", 9/16" 5 mm, 5.5 mm, 6 mm, 7 mm, 8 mm, 9 mm, 10 mm, 11 mm, 12 mm, 13 mm, 14 mm, 15 mm / 76 mm extension, 152 mm extension, universal joint	50	1	4932464944	4058546228897
③ Metric 3/8" ratchet + socket set (32 pc) Standard sockets: 6 mm, 7 mm, 8 mm, 9 mm, 10 mm, 11 mm, 12 mm, 13 mm, 14 mm, 15 mm, 16 mm, 17 mm, 18 mm, 19 mm / Deep well sockets: 6 mm, 7 mm, 8 mm, 9 mm, 10 mm, 11 mm, 12 mm, 13 mm, 14 mm, 15 mm, 16 mm, 17 mm, 18 mm, 19 mm / 76 mm extension, 152 mm extension, universal joint	32	1	4932464945	4058546228903
④ Metric & imperial 3/8" ratchet + socket set (56 pc) Standard sockets: 1/4", 5/16", 3/8", 7/16", 1/2", 9/16", 5/8", 11/16", 3/4", 13/16", 7/8", 9/16", 6 mm, 7 mm, 8 mm, 9 mm, 10 mm, 11 mm, 12 mm, 13 mm, 14 mm, 15 mm, 16 mm, 17 mm, 18 mm, 19 mm / Deep well sockets: 1/4", 5/16", 3/8", 7/16", 1/2", 9/16", 5/8", 11/16", 3/4", 13/16", 7/8", 9/16", 6 mm, 7 mm, 8 mm, 9 mm, 10 mm, 11 mm, 12 mm, 13 mm, 14 mm, 15 mm, 16 mm, 17 mm, 18 mm, 19 mm / 76 mm extension, 152 mm extension, universal joint	56	1	4932464946	4058546228910
⑤ Metric 1/2" ratchet + socket set (28 pc) Standard sockets: 10 mm, 11 mm, 12 mm, 13 mm, 14 mm, 15 mm, 16 mm, 17 mm, 18 mm, 19 mm, 20 mm, 21 mm, 22 mm, 23 mm, 24 mm / Deep well sockets: 10 mm, 11 mm, 12 mm, 13 mm, 14 mm, 15 mm, 16 mm, 17 mm, 18 mm, 19 mm / 76 mm extension, 127 mm extension & removable storage tray	28	1	4932471864	4058546297633
⑥ Metric 1/4" ratchet + socket set (28 pc) in PACKOUT[™] compact slim organiser Standard sockets: 5 mm, 5.5 mm, 6 mm, 7 mm, 8 mm, 9 mm, 10 mm, 11 mm, 12 mm, 13 mm, 14 mm, 15 mm / Deep well sockets: 5 mm, 5.5 mm, 6 mm, 7 mm, 8 mm, 9 mm, 10 mm, 11 mm, 12 mm, 13 mm, 14 mm, 15 mm	28	1	4932478812	4058546360948
⑦ Metric 3/8" ratchet + socket set (32 pc) in PACKOUT[™] compact slim organiser Standard sockets: 6 mm, 7 mm, 8 mm, 9 mm, 10 mm, 11 mm, 12 mm, 13 mm, 14 mm, 15 mm, 16 mm, 17 mm, 18 mm, 19 mm / Deep well sockets: 6 mm, 7 mm, 8 mm, 9 mm, 10 mm, 11 mm, 12 mm, 13 mm, 14 mm, 15 mm, 16 mm, 17 mm, 18 mm, 19 mm	32	1	4932478813	4058546360955



1/4" Ratchet, driver & socket set

- 90 tooth design with 4 °of arc swing for tight work spaces.
- FOUR FLAT™ sides on socket deter rolling.
- Sockets are stamped with measurements on the flat side for easy-to-read visibility.
- Comfortable Tri-Lobe screwdriver handle optimised for maximum user comfort and high torque applications.
- SHOCKWAVE™ IMPACT DUTY Screwdriver bits



Description	Pack quantity	Min. order quantity	Article Number	EAN Code
1/4" Ratchet, Driver & Socket set				
1/4 Ratchet , 1/4 Tri-lobe screwdriver handle, Standard sockets: 5.5 mm, 6 mm, 7 mm 8 mm, 9 mm, 10 mm, 11 mm, 12 mm, 13 mm, 14 mm, Extensions: 76 mm, 152 mm, Shockwave Bits: SL4.5 / SL5.5 / SL6.5 / PH1 / PH2 / PH3 / PZ1 / PZ2 / PZ3 / HEX 3 / HEX 4 / HEX 5 / HEX 6 / HEX 8 / TR10 / TR15 / TR20 / TR25 / TR27 / TR30 / TR40, Uni joint, Socket adaptor, 1/4SQ-1/4 Hex socket	38	1	4932479096	4058546368906

Tradesman 3/8" ratchet set

- Pivoting ratchet head.
- Slim profile design for better access.
- Square shaped sockets compatible with combination spaners.
- Organised and portable storage solution.



Description	Pack quantity	Min. order quantity	Article Number	EAN Code
Tradesman 3/8" ratchet set (12 pc)				
3/8" sockets: 10, 12, 13, 14, 15, 17, 18 and 19 mm. 3/8" ratchet. 152 mm extension. 1/4" to 3/8" adaptor and 3/8" to 1/4" adaptor	12	1	48229001	045242495078



Pry bar

NEW

- I-Beam design for added durability
- All-metal core for improved durability
- Hammer-ready strike cap improves leverage when working in tight spaces
- Comfortable Tri-Lobe handles for better grip
- All-chrome shafts for increased durability
- Curved claw design reduces damage when pulling nails

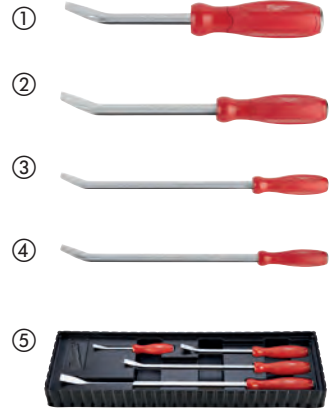

Description	Pack quantity	Min. order quantity	Article Number	EAN Code
① 200mm Pry bar	1	1	4932480595	4058546408800
② 300mm Pry bar	1	1	4932480596	4058546408817
③ 450mm Pry bar	1	1	4932480597	4058546408824
④ 600mm Pry bar	1	1	4932480598	4058546408831
⑤ Pry bar set - 4 pcs 200 mm - 300 mm - 450 mm - 600 mm	1	1	48229214	045242508099



Hook & pick set

- All-metal core for long-lasting durability and rust protection.
- Chrome-plated shanks reduce corrosion and provide rust protection.
- Comfort grip handle and precision knurling increase tool control and user comfort.
- Supplied in an easy-access storage tray for long-term tool storage.

Description	Pack quantity	Min. order quantity	Article Number	EAN Code
① Hose Pick - Flat Tip	1	1	4932480570	4058546408558
② Hose Pick - Hook	1	1	4932480571	4058546408565
③ Hose Pick - Bent 90 Degree	1	1	4932480572	4058546408572
④ Hose Pick - Bent 45 Degree	1	1	4932480573	4058546408589
⑤ Hook & pick set	4	1	48229215	045242508105
⑥ Heavy Duty Hook & Pick Set (4 pc)	4	1	4932480568	4058546408534
⑦ Hook & Pick Set (8 pc)	8			

NEW





Nothing but **HEAVY DUTY.**[™]

**BOLT[™] 200
HELMET**

M12[™] HEATED VEST

**CUT RESISTANT &
SPECIAL APPLICATION
GLOVES**

**TOOL
LANYARDS**

**KNEE
PADS**



**STAY SAFE.
STAY PRODUCTIVE**



BOLT™200

NEW

- Shell in Lexan - ultra resistant to impact.
- BOLT™ system – ensure compatibility between the accessories with an easy and intuitive attachment system. Large range of BOLT™ accessories available.
- Extremely comfortable and easy to adjust wheel ratchet adjustment system.
- Foam suspension providing consistent impact performance independent of impact location.
- Comfortable inner foam suspension completed with a crown liner for extra comfort.
- Breathable, washable and replaceable premium sweatband.
- Breathable, washable and replaceable premium crown liner.
- Vented version delivered with a mounted EN 12492 certified chinstrap (color coded red).
- Vented and unvented versions delivered with an EN 397 certified chinstrap (non mounted, color coded grey).
- Certified as per EN 397:2012 with options extreme temperatures – 40°C, Lateral Deformation and Electrical insulation 440 V a.c. (unvented version).
- Certified as per EN 12492:2012 (vented version) and EN12492: 2012 except clause 4.1.4 (unvented version).

Description	Pack quantity	Min. order quantity	Article Number	EAN Code
BOLT™200 White Vented - 1pc	1	1	4932478141	4058546340742
BOLT™200 Yellow Vented - 1pc	1	1	4932478918	4058546362003
BOLT™200 Red Vented - 1pc	1	1	4932478919	4058546362010
BOLT™200 Black Vented - 1pc	1	1	4932478920	4058546362027
BOLT™200 Blue Vented - 1pc	1	1	4932480651	4058546409364
BOLT™200 Green Vented - 1pc	1	1	4932480652	4058546409371
BOLT™200 Orange Vented - 1pc	1	1	4932480653	4058546409388
BOLT™200 Hi-Vis Vented - 1pc	1	1	4932480654	4058546409395

Description	Pack quantity	Min. order quantity	Article Number	EAN Code
BOLT™200 White Unvented - 1pc	1	1	4932479252	4058546370466
BOLT™200 Yellow Unvented - 1pc	1	1	4932479253	4058546370473
BOLT™200 Red Unvented - 1pc	1	1	4932479254	4058546370480
BOLT™200 Black Unvented - 1pc	1	1	4932479255	4058546370497
BOLT™200 Blue Unvented - 1pc	1	1	4932480655	4058546409401
BOLT™200 Green Unvented - 1pc	1	1	4932480656	4058546409418
BOLT™200 Orange Unvented - 1pc	1	1	4932480657	4058546409425
BOLT™200 Hi-Vis Yellow Unvented - 1pc	1	1	4932480658	4058546409432



USB rechargeable bolt headlamp 600 lumens

- 600 lumens of multi-directional TRUEVIEW™ high definition light output
- Full BOLT compatibility with low profile design works with all BOLT visors and helmets
- Direct mount to helmet without straps
- Pivoting light head to help users direct light where it is needed most
- 4 modes to manage output or runtime with up to 12 hours of runtime on (1) USB 3.0 Battery
- Fuel gauge allows fast checking of REDLITHIUM™ USB battery charge
- Conveniently charge REDLITHIUM™ USB battery internally with micro-USB Type C cable from USB power source or AC outlet (wall plug not included)
- IP54 rating, light is protected from dust and falling water
- Jobsite tough micro-USB braided cable with metal ends
- Includes USB cable



Description	Pack quantity	Min. order quantity	Article Number	EAN Code
USB rechargeable BOLT headlamp 600 lumens	1	1	4933479902	4058546376963

BOLT[™] Face Shield

NEW

- Full face shield with panoramic field of vision.
- BOLT[™] system – ensure compatibility between the accessorize with an easy and intuitive attachment system. Large range of BOLT[™] accessories available.
- Compatible with the BOLT[™] Lamp: possibility to lift the face shield even with the lamp installed.
- Extremely easy and intuitive installation and removal.
- Lens made of polycarbonate.
- Lens certified anti-scratch K as per EN166.
- Lens certified anti-fog N as per EN166.
- 2 lens tints available: clear and grey.
- The Compact version offers a slim and compact design.
- The Universal version can be adapted on both BOLT[™] 100 and BOLT[™] 200 helmets thanks to an easy switch system.
- The mesh versions have an impact resistance rated F as per EN 1731, mesh made of steel. This version is ideal for outdoor and gardening/ maintenance applications.
- The mesh versions have a light transmission > 60 %.

Description	Pack quantity	Min. order quantity	Article Number	EAN Code
① BOLT [™] Face Shield Compact Clear	1	1	4932479943	4058546377373
② BOLT [™] Face Shield Compact Grey	1	1	4932479944	4058546377380
③ BOLT [™] Mesh Face Shield Compact	1	1	4932479945	4058546377397
BOLT [™] Face Shield Compact Clear Replacement (5 pc)	5	1	4932492327	4058546416942
BOLT [™] Face Shield Compact Grey Replacement (5 pc)	5	1	4932492328	4058546416959
BOLT [™] Face Shield Compact Carrier Replacement	1	1	4932492329	4058546416966
BOLT [™] Face Shield Universal Clear Replacement	1	1	4932492324	4058546416911
BOLT [™] Face Shield Universal Grey Replacement	1	1	4932492325	4058546416928
BOLT [™] Face Shield Universal Carrier Replacement	1	1	4932492326	4058546416935



BOLT[™] Visor

NEW

- Visor with panoramic field of vision.
- BOLT[™] system – ensure compatibility between the accessorize with an easy and intuitive attachment system. Large range of BOLT[™] accessories available.
- Compatible with the BOLT[™] Lamp: possibility to lift the visor even with the lamp installed.
- Extremely easy and intuitive installation and removal.
- Lens made of polycarbonate.
- Lens certified anti-scratch K as per EN166.
- Lens certified anti-fog N as per EN166.
- 2 lens tints available: clear and tinted, for outdoor applications.
- The Compact version offers a slim and compact design.
- The Universal version can be adapted on both BOLT[™] 100 and BOLT[™] 200 helmets thanks to an easy switch system.

Description	Pack quantity	Min. order quantity	Article Number	EAN Code
① BOLT [™] Visor Compact Clear	1	1	4932479946	4058546377403
② BOLT [™] Visor Compact Tinted	1	1	4932479947	4058546377410
BOLT [™] Visor Clear Lens Replacement (5 pc)	5	1	4932492330	4058546416973
BOLT [™] Visor Tinted Lens Replacement (5pc)	5	1	4932492331	4058546416980
BOLT [™] Visor Compact Carrier Replacement	1	1	4932492333	4058546417000
BOLT [™] Visor Universal Carrier Replacement	1	1	4932492332	4058546416997



BOLT[™] 200 Spare Parts

NEW

Name	Pack quantity	Min. order quantity	Article Number	EAN Code
Replacement Sweatband BOLT200	10	1	4932480659	4058546409449
Replacement Crown liner BOLT200	10	1	4932480660	4058546409456
4pts EN397 chinstrap BOLT	10	1	4932480661	4058546409463
4pts EN12492 chinstrap BOLT200	10	1	4932480662	4058546409470



Premium safety glasses with gasket

ANTI-SCRATCH LENSES

COMFORTABLE, FLEXIBLE ARMS FOR EXTENDED WEAR

LONG LASTING ANTI-FOG LENSES

REMOVABLE GASKET PROTECTS AGAINST DEBRIS

FLEXIBLE NOSE PIECE

INCLUDES A SOFT CASE

ALSO AVAILABLE IN TINTED LENSES FOR OUTDOOR WORK

	Lens colour	Packaging style	Pack quantity	Min. order quantity	Article Number	EAN Code
①	Clear	Blister packaging	1	1	4932471885	4058546297848
②	Polarised	Blister packaging, Блистер	1	1	4932471886	4058546297855

Performance safety glasses



- Durable anti-scratch lenses.
- Long lasting anti-fog lenses.
- Comfortable and flexible arms for extended comfort wear.
- Clear and tinted options offer eye protection whether working indoors or outdoors.
- European Certified: EN166 and EN170 / EN172.



	Lens colour	Packaging style	Pack quantity	Min. order quantity	Article Number	EAN Code
①	Clear	Blister packaging	1	1	4932471883	4058546297824
		Bulk Pack (48pcs)	48	1	4932479027	4058546363178
②	Tinted	Blister packaging	1	1	4932471884	4058546297831
		Bulk Pack (48pcs)	48	1	4932479028	4058546363185
③	Grey	Blister packaging	1	1	4932478908	4058546361907
		Bulk Pack (48pcs)	48	1	4932479029	4058546363192
④	Yellow	Blister packaging	1	1	4932478928	4058546362102

Safety glasses

- Light weight for extended comfort while wearing.
- Fully adjustable and removable nose bridge to fit comfortably all face shapes.
- Comfortable and flexible arms for extended comfort wear.
- Clear and tinted options offer eye protection whether working indoors or outdoors.
- European Certified: EN166 and EN170 / EN172.

	Lens colour	Packaging style	Pack quantity	Min. order quantity	Article Number	EAN Code
①	Clear	Polybag	1	12	4932471881	4058546297800
②	Tinted	Polybag	1	12	4932471882	4058546297817

Enhanced safety glasses



- Light weight for extended comfort while wearing.
- Durable anti-scratch lenses.
- Long lasting anti-fog lenses.
- Comfortable and flexible arms for extended comfort wear.
- Clear and tinted options offer eye protection whether working indoors or outdoors.
- European Certified: EN166 and EN170 / EN172.

	Lens colour	Packaging style	Pack quantity	Min. order quantity	Article Number	EAN Code
①	Clear	Polybag	1	1	4932478763	4058546360450
		Bulk Pack (144pcs)	144	1	4932479024	4058546363147
②	Tinted	Polybag	1	1	4932478764	4058546360467
		Bulk Pack (144pcs)	144	1	4932479025	4058546363154
③	Grey	Polybag	1	1	4932478907	4058546361891
		Bulk Pack (144pcs)	144	1	4932479026	4058546363161
④	Yellow	Polybag	1	1	4932478927	4058546362096



Magnified safety glasses



- Magnified lenses - Offer users an optical correction to improve their eyesight for close application.
- 4 magnifying intensity: +1 / +1.5 / +2 / +2.5
- Light weight for extended comfort while wearing.
- Durable anti-scratch lenses.
- Comfortable and flexible arms for extended comfort wear.
- European Certified: EN166.

Description	Pack quantity	Min. order quantity	Article number	EAN Code
Clear Safety Glasses (+1)	1	1	4932478909	4058546361914
Clear Safety Glasses (+1.5)	1	1	4932478910	4058546361921
Clear Safety Glasses (+2)	1	1	4932478911	4058546361938
Clear Safety Glasses (+2.5)	1	1	4932478912	4058546361945

Hard Case For Safety Glasses



Name	Pack quantity	Min. order quantity	Article Number	EAN Code
Hard Case Safety Glasses - 1 pc	1	1	4932492083	4058546414504

FFP2 Respirator

- FFP2 rating - filtering facepiece gives up to 94% protection.
- Flexible aluminium nose bridge - adjustable fit.
- Comfortable adjustable straps - easy fit.
- Anti-clogging inner layer - Stay cool all day long.
- Compatible with MILWAUKEE® safety eyewear.
- European Certified as FFP2 disposable respirator according to EN149: 2001/A1:2009.



Description	Pack quantity	Min. order quantity	Article Number	EAN Code
FFP2 Respirator - 20pc	20	1	4932479237	4058546370312

FFP2 Foldable Respirator

- FFP2 rating - filtering facepiece gives up to 94% protection.
- Foldable respirator - Flat fold for easy carrying on job site.
- Flexible aluminium nose bridge - adjustable fit.
- Comfortable adjustable straps - easy fit.
- Compatible with MILWAUKEE® safety eyewear.
- European Certified as FFP2 disposable respirator according to EN149: 2001/A1:2009.



Description	Pack quantity	Min. order quantity	Article number	EAN Code
FFP2 Foldable Respirator - 20pc	20	1	4932479238	4058546370329

FFP3 Disposable Respirator with Valve

- FFP3 rating - highest filtering facepiece gives up to 99% protection (including asbestos & silica).
- One way valve - fog free and easy breathing.
- Exhalation valve - easy breathing.
- Flexible aluminium nose bridge - adjustable fit.
- Comfortable adjustable straps - easy fit.
- Anti-clogging inner layer - Stay cool all day long.
- Comfortable tight sealed gasket - prevents dust and debris.
- Compatible with MILWAUKEE® safety eyewear.
- European Certified as FFP3 disposable respirator according to EN149: 2001/A1:2009.



Description	Pack quantity	Min. order quantity	Article Number	EAN Code
FFP3 Respirator w/ Gasket - 10pc	10	1	4932471906	4058546298050

FFP2 Respirator with Valve

- FFP2 rating - filtering facepiece gives up to 94% protection.
- One way valve - fog free and easy breathing.
- Exhalation valve - easy breathing.
- Flexible aluminium nose bridge - adjustable fit.
- Comfortable adjustable straps - easy fit.
- Anti-clogging inner layer - Stay cool all day long.
- Compatible with MILWAUKEE® safety eyewear.
- European Certified as FFP2 disposable respirator according to EN149: 2001/A1:2009.



Description	Pack quantity	Min. order quantity	Article Number	EAN Code
FFP2 Respirator w/ Valve - 10pc	10	1	4932478548	4058546347413

FFP2 Foldable Respirator with Valve

- FFP2 rating - filtering facepiece gives up to 94% protection.
- Foldable respirator - Flat fold for easy carrying on job site.
- One way valve - fog free and easy breathing.
- Exhalation valve - easy breathing.
- Flexible aluminium nose bridge - adjustable fit.
- Comfortable adjustable straps - easy fit.
- Anti-clogging inner layer - Stay cool all day long.
- Compatible with MILWAUKEE® safety eyewear.
- European Certified as FFP2 disposable respirator according to EN149: 2001/A1:2009.



Description	Pack quantity	Min. order quantity	Article Number	EAN Code
FFP2 Foldable Respirator w/ Valve	15	1	4932478801	4058546360832

Foam ear plugs

NEW

- Efficient jobsite noise attenuation of SNR = 38 dB.
- Comfortable foam - to wear all day.
- Quick expansion to ensure a rapid and secure seal.
- Individually packed pairs (200 pairs), resealable packaging (10 pairs) for hygienic and easy distribution.
- European Certified hearing protectors: EN352-2 (SNR = 38 dB; H = 37; M = 36 dB; L = 32 dB).



Description	Pack quantity	Min. order quantity	Article Number	EAN Code
Foam ear plugs	1	1	4932480464	4058546407490
Foam ear plugs	200	1	4932480465	4058546407506

Banded ear plugs

- 3-point wear: above head, below chin and behind the neck.
- Pivoting arms to adjust and pivot the band to a secure and comfortable position while being worn.
- Earplugs can be worn continuously even if the wearing position is changed – permanent protection.
- Interchangeable foam earplugs and tpr flanged earplugs included.
- Durable and comfortable band for a long lifetime.
- European Certified hearing protectors: EN 352-2 (SNR TPR ear plugs = 32 dB; SNR Foam ear plugs = 33 dB).



Description	Pack quantity	Min. order quantity	Article Number	EAN Code
① Banded Ear Plugs	1	1	4932478135	4058546340681
② Foam Replacement - 5 pairs	5	1	4932478550	4058546347437
③ TPR Replacement - 5 pairs	5	1	4932478549	4058546347420

Reusable corded ear plugs

- Efficient jobsite noise attenuation of SNR = 31 dB.
- Corded solution for easy access - can be worn around the neck.
- Comfortable silicone - all day comfort.
- Quick-fit design to quickly insert and remove while achieving a secure seal.
- Storage box included - keep the ear plugs clean.
- European Certified hearing protectors: EN352-2 (SNR = 31 dB).



Description	Pack quantity	Min. order quantity	Article Number	EAN Code
Reusable corded ear plugs	3	1	4932471904	4058546298036

PACKOUT™ First Aid Kit DIN 13157

- Quickly identifiable during an emergency due to red coloured PACKOUT™ Compact Organiser.
- Part of the PACKOUT™ modular storage system.
- Constructed with impact resistant polymers for jobsite durability.
- IP65 rated weather seal to keep out rain and jobsite debris.
- The interior features 5 removable & mountable bins.
- No-travel bins seals to prevent the bins contents from migrating between bins during transport.
- DIN 13157:2021-11 compliant first aid kit.



Description	Pack quantity	Min. order quantity	Article Number	EAN Code
PACKOUT™First Aid Kit DIN 13157	1	1	4932478879	4058546361617

PREMIUM HIGH-VISIBILITY VEST

15 Storage Pockets

External:

- 2 Mic Tabs
- 1 Clear ID Holder
- 2 Chest Pockets
- 4 Reinforced Pen Pockets
- 2 Reinforced Barrel Pockets
- 1 Tablet Pocket

Internal:

- 1 Chest Pocket
- 2 Barrel Pockets



Premium high-visibility vest

- 15 pockets - increased carrying capacity.
- 1 clear ID badge holder - easy identification on the jobsite.
- 1 back pocket - ideal to carry tablet or notebook.
- Quick internal size adjustment - size up or size down for better fit.
- Padded collar - added comfort for extended wear.
- Harness tethering hole - ideal to fit over harness to add more safety on the jobsite.
- European Certified as Class 2 High Visibility Clothing according to EN ISO 20471: 2013/A1:2016.



Description	Colour	Pack quantity	Min. order quantity	Article Number	EAN Code
Premium high-visibility vest yellow - S/M	Yellow	1	1	4932471895	4058546297947
Premium high-visibility vest yellow - L/XL	Yellow	1	1	4932471896	4058546297954
Premium high-visibility vest yellow - 2XL/3XL	Yellow	1	1	4932471897	4058546297961

Premium high-visibility vest orange

Description	Colour	Pack quantity	Min. order quantity	Article Number	EAN Code
Premium high-visibility vest orange - S/M	Orange	1	1	4932471898	4058546297978
Premium high-visibility vest orange - L/XL	Orange	1	1	4932471899	4058546297985
Premium high-visibility vest orange - 2XL/3XL	Orange	1	1	4932471900	4058546297992



HIGH-VISIBILITY VEST

10 Storage Pockets

External:

- 2 Mic Tabs
- 1 Clear ID Holder
- 2 Chest Pockets
- 4 Reinforced Pen Pockets

Internal:

- 1 Chest Pocket



High-visibility vest

- 10 pockets - increased carrying capacity.
- 1 clear ID badge holder - easy identification on the jobsite.
- Quick internal size adjustment - size up or size down for better fit.
- Harness tethering hole - ideal to fit over harness to add more safety on the jobsite.
- European Certified as Class 2 High Visibility Clothing according to EN ISO 20471: 2013/A1:2016.



Description	Colour	Pack quantity	Min. order quantity	Article Number	EAN Code
High-visibility vest yellow - S/M	Yellow	1	1	4932471889	4058546297886
High-visibility vest yellow - L/XL	Yellow	1	1	4932471890	4058546297893
High-visibility vest yellow - 2XL/3XL	Yellow	1	1	4932471891	4058546297909

High-visibility vest orange

Description	Colour	Pack quantity	Min. order quantity	Article Number	EAN Code
High-visibility vest orange - S/M	Orange	1	1	4932471892	4058546297916
High-visibility vest orange - L/XL	Orange	1	1	4932471893	4058546297923
High-visibility vest orange - 2XL/3XL	Orange	1	1	4932471894	4058546297930





MILWAUKEE® GLOVES GUIDE

Rating	4	3	4	3	C	X
Abrasion	1-4	←	←	←	←	←
Cut (Coup Test)	1-5	←	←	←	←	←
Tear	1-4	←	←	←	←	←
Puncture	1-4	←	←	←	←	←
Cut (TDM-100 Test)	A-F	←	←	←	←	←
Impact Protection	P,FX	←	←	←	←	←

X= Not tested P= Pass X= Fail

CUT RESISTANT GLOVES

PROTECTIVE SLEEVES

GLOVE TYPES



NEW

NEW

NEW

	CUT LEVEL A	CUT LEVEL B	CUT LEVEL C	CUT LEVEL D	CUT LEVEL E	CUT LEVEL F	CUT LEVEL C	CUT LEVEL E
FEATURES								
EN 388 RATING	4121A	4242B	4343C	4X43D	4X44E	4X43F	2342C	3X42E
COLOUR CODE								
GAUGE	13	15	15	13	13	18	15	13
COATING	Nitrile - Sandy	Nitrile - Sandy	Nitrile - Microfoam	Nitrile - Sandy	Nitrile - Sandy	Nitrile - Sandy	-	-
ENVIRONMENT	Dry, damp, oily (WASHABLE)	Dry, damp, oily (WASHABLE)	Dry, damp, oily (WASHABLE)	Dry, damp, oily (WASHABLE)	Dry, damp, oily (WASHABLE)	Dry, damp, oily (WASHABLE)	-	-
APPLICATIONS								
AUTOMOTIVE/TRANSPORTATION	✓	✓	✓	-	-	-	✓	-
CARPENTRY	✓	✓	-	-	-	-	✓	-
CIVIL ENGINEERING	✓	✓	✓	✓	✓	-	✓	✓
CONSTRUCTION	✓	✓	✓	✓	✓	-	✓	✓
DEMOLITION	-	-	✓	✓	✓	-	✓	✓
DRYWALL, CEILING AND PARTIONING	-	✓	✓	✓	-	-	✓	✓
LANDSCAPING AND HORTICULTURAL	✓	✓	-	-	-	-	✓	-
MAINTENANCE, REPAIR AND OPERATIONS	-	-	-	-	-	-	-	-
MANUFACTURING	✓	✓	✓	✓	✓	✓	✓	✓
ASSEMBLE	✓	✓	-	-	-	-	✓	-
METALWORKING AND ENGINEERING	-	-	✓	✓	✓	✓	✓	✓
HVAC	-	-	✓	✓	✓	✓	-	✓
PLUMBING	✓	✓	✓	-	-	-	-	-
UTILITIES	✓	✓	✓	-	-	-	✓	-
OIL & GAS	✓	✓	✓	✓	✓	✓	-	-

FEATURES KEY



EN388:2016



COMFORT



DEXTERITY



SMARTSWIPE™



CUT RESISTANCE A



CUT RESISTANCE B



CUT RESISTANCE C



CUT RESISTANCE D



CUT RESISTANCE E



CUT RESISTANCE F



HIGH VISIBILITY



BREATHABILITY



PUNCTURE RESISTANCE & GRIP PERFORMANCE



WINTER



LEATHER



IMPACT RESISTANT



REINFORCED PALM



DURABILITY



REINFORCED WITH ARMORTEX®



REINFORCEMENT

HI-VIS CUT RESISTANT GLOVES

HI-DEX CUT RESISTANT GLOVES



HI-VIS CUT LEVEL A	HI-VIS CUT LEVEL B	HI-VIS CUT LEVEL C	HI-VIS CUT LEVEL D	HI-VIS CUT LEVEL E	HI-DEX CUT LEVEL B	HI-DEX CUT LEVEL C	HI-DEX CUT LEVEL D
3121A	3242B	4X42C	4X43D	4X43E	4242B	4342C	4X42D
15	15	15	13	13	18	18	18
Polyurethane (PU)	Polyurethane (PU)	Polyurethane (PU)	Polyurethane (PU)	Polyurethane (PU)	Polyurethane (PU)	Polyurethane (PU)	Polyurethane (PU)
Dry (WASHABLE)	Dry (WASHABLE)	Dry (WASHABLE)	Dry (WASHABLE)	Dry (WASHABLE)	Dry (WASHABLE)	Dry (WASHABLE)	Dry (WASHABLE)
✓	✓	✓	✓	✓	✓	✓	✓
✓	✓	-	-	-	✓	✓	-
✓	✓	✓	✓	✓	✓	✓	✓
✓	✓	✓	✓	✓	✓	✓	✓
-	-	-	-	-	-	-	-
-	✓	✓	✓	-	✓	✓	✓
-	-	-	-	-	-	-	-
-	-	-	-	-	-	-	-
✓	✓	✓	✓	✓	✓	✓	✓
✓	✓	-	-	-	✓	✓	✓
-	-	✓	✓	✓	-	✓	✓
-	-	✓	✓	✓	-	✓	✓
-	-	-	-	-	-	-	-
✓	✓	✓	-	-	✓	✓	✓
-	-	-	-	-	-	-	-



MILWAUKEE® GLOVES GUIDE

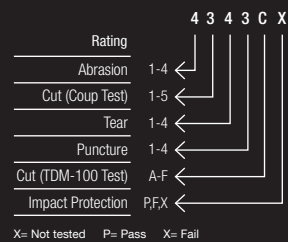

GLOVE TYPES



	CUT LEVEL A	CUT LEVEL B	CUT LEVEL C	CUT LEVEL D	CUT LEVEL E	HYBRID LEATHER	LEATHER
FEATURES							
EN 388 RATING	EN388: 1141A EN511: 01X	EN388: 2242B EN511: X1X	EN388: 2442C EN511: 02X	EN388: 3X43D EN511: X1X	EN 388: 3X43E EN 511: X1X	2122X	2122X
COLOUR CODE						-	-
GAUGE	15,10	15,10	15,7	15,10	13,10	-	-
COATING	Latex	Latex	Latex	Latex	Latex	-	-
ENVIRONMENT	Cold, damp, dry (WASHABLE)	Cold, damp, dry (WASHABLE)	Cold, damp, dry (WASHABLE)	Cold, damp, dry (WASHABLE)	Cold, damp, dry (WASHABLE)	(WASHABLE)	(WASHABLE)
APPLICATIONS							
AUTOMOTIVE/ TRANSPORTATION	✓	-	-	-	-	-	-
CARPENTRY	✓	✓	-	-	-	✓	✓
CIVIL ENGINEERING	-	-	-	-	-	-	-
CONSTRUCTION	✓	✓	✓	✓	✓	✓	✓
DEMOLITION	-	-	✓	✓	✓	-	-
DRYWALL, CEILING AND PARTIONING	-	✓	✓	✓	-	-	-
LANDSCAPING AND HORTICULTURAL	✓	✓	-	-	-	✓	✓
MAINTENANCE, REPAIR AND OPERATIONS	-	-	-	-	-	-	-
MANUFACTURING	✓	✓	-	-	-	-	-
ASSEMBLE	-	-	-	-	-	-	-
METALWORKING AND ENGINEERING	-	-	-	✓	✓	-	-
HVAC	-	-	✓	✓	✓	-	-
PLUMBING	✓	✓	-	-	-	-	-
UTILITIES	✓	✓	-	-	-	✓	✓
OIL & GAS	✓	✓	✓	✓	✓	-	-

FEATURES KEY



EN388:2016



COMFORT



DEXTERITY



SMARTSWIPE™



CUT RESISTANCE A



CUT RESISTANCE B



CUT RESISTANCE C



CUT RESISTANCE D



CUT RESISTANCE E



CUT RESISTANCE F



HIGH VISIBILITY



BREATHABILITY



PUNCTURE RESISTANCE & GRIP PERFORMANCE



WINTER



LEATHER



IMPACT RESISTANT



REINFORCED PALM



DURABILITY



REINFORCED WITH ARMORTEX®



REINFORCEMENT

WORK GLOVES

IMPACT GLOVES



FREE FLEX	FINGERLESS	DEMOLITION	WINTER DEMOLITION	IMPACT CUT LEVEL C	IMPACT CUT LEVEL E	IMPACT DEMOLITION
2121X	2121X	2121X	EN 388: 2122A EN 511: 14X	4343CP	4X44EP	2121XP
-	-	-	-	-	-	-
-	-	-	-	18	13	-
-	-	-	-	Nitrile	Nitrile	-
Dry (WASHABLE)	Dry (WASHABLE)	Dry, damp (WASHABLE)	Cold, damp, dry (WASHABLE)	Dry, damp, oily (WASHABLE)	Dry, damp, oily (WASHABLE)	Dry (WASHABLE)
✓	-	-	-	✓	-	-
✓	✓	✓	✓	-	-	-
-	-	-	-	-	-	-
✓	✓	✓	✓	✓	✓	✓
-	-	✓	✓	✓	✓	✓
-	-	-	-	✓	-	-
-	-	-	-	-	-	-
-	-	-	-	✓	-	-
-	-	-	-	-	✓	-
-	-	✓	✓	✓	✓	-
✓	✓	-	-	-	-	-
✓	✓	✓	✓	-	-	-
-	-	✓	✓	✓	✓	✓

Cut resistant dipped gloves

Description	Colour code	Size	Pack quantity	Min. order quantity	Article Number	EAN Code
① Cut A Gloves	White	7 / S	1	1	4932479712	4058546375065
		7 / S	12	1	4932479713	4058546375072
		7 / S	144	1	4932479714	4058546375089
		8 / M	1	1	4932471416	4058546290443
		8 / M	12	1	4932471614	4058546295134
		8 / M	144	1	4932479008	4058546362980
		9 / L	1	1	4932471417	4058546290450
		9 / L	12	1	4932471615	4058546295141
		9 / L	144	1	4932479009	4058546362997
		10 / XL	1	1	4932471418	4058546290467
		10 / XL	12	1	4932471616	4058546295158
		10 / XL	144	1	4932479010	4058546363000
		11 / XXL	1	1	4932471419	4058546290474
		11 / XXL	12	1	4932471617	4058546295165
		11 / XXL	144	1	4932479011	4058546363017
② Cut B Gloves	Blue	7 / S	1	1	4932479906	4058546377007
		8 / M	1	1	4932479907	4058546377014
		9 / L	1	1	4932479908	4058546377021
		10 / XL	1	1	4932479909	4058546377038
		11 / XXL	1	1	4932479910	4058546377045
③ Cut C Gloves	Black	7 / S	1	1	4932479715	4058546375096
		7 / S	12	1	4932479716	4058546375102
		7 / S	144	1	4932479717	4058546375119
		8 / M	1	1	4932471420	4058546290481
		8 / M	12	1	4932471618	4058546295172
		8 / M	144	1	4932479012	4058546363024
		9 / L	1	1	4932471421	4058546290498
		9 / L	12	1	4932471619	4058546295189
		9 / L	144	1	4932479013	4058546363031
		10 / XL	1	1	4932471422	4058546290504
		10 / XL	12	1	4932471620	4058546295196
		10 / XL	144	1	4932479014	4058546363048
		11 / XXL	1	1	4932471423	4058546290511
		11 / XXL	12	1	4932471621	4058546295202
11 / XXL	144	1	4932479015	4058546363055		
④ Cut D Gloves	Grey	7 / S	1	1	4932479911	4058546377052
		8 / M	1	1	4932479912	4058546377069
		9 / L	1	1	4932479913	4058546377076
		10 / XL	1	1	4932479914	4058546377083
		11 / XXL	1	1	4932479915	4058546377090
⑤ Cut E Gloves	Red	7 / S	1	1	4932479718	4058546375126
		7 / S	12	1	4932479719	4058546375133
		7 / S	144	1	4932479720	4058546375140
		8 / M	1	1	4932471424	4058546290528
		8 / M	12	1	4932471622	4058546295219
		8 / M	144	1	4932479016	4058546363062
		9 / L	1	1	4932471425	4058546290535
		9 / L	12	1	4932471623	4058546295226
		9 / L	144	1	4932479017	4058546363079
		10 / XL	1	1	4932471426	4058546290542
		10 / XL	12	1	4932471624	4058546295233
		10 / XL	144	1	4932479018	4058546363086
		11 / XXL	1	1	4932471427	4058546290559
		11 / XXL	12	1	4932471625	4058546295240
11 / XXL	144	1	4932479019	4058546363093		

Description	Colour code	Size	Pack quantity	Min. order quantity	Article Number	EAN Code
⑥ High Cut F Gloves	Purple	7 / S	1	1	4932492040	4058546413521
		7 / S	12	1	4932492045	4058546413576
		8 / M	1	1	4932492041	4058546413538
		8 / M	12	1	4932492046	4058546413583
		9 / L	1	1	4932492042	4058546413545
		9 / L	12	1	4932492047	4058546413590
		10 / XL	1	1	4932492043	4058546413552
		10 / XL	12	1	4932492048	4058546413606
		11 / XXL	1	1	4932492044	4058546413569
		11 / XXL	12	1	4932492049	4058546413613



Cut C Sleeves

NEW

- High stretch nylon material with 4-way stretch points to fit users' arms.
- Tapered design, wider on the bicep and tight on the wrist, to fit the natural arm form.
- Elastic band with non-slip dots on the bicep and stretch wrist cuff to keep the sleeves in place and prevent them from sagging.
- Breathable and lightweight material provides good dexterity and all-day comfort.
- Elastic thumb loop avoids pressure points when using gloves.
- European Certified for cut protection: EN ISO 21420, EN388:2016 (2342C), UKCA.



Description	Cut level	Colour code	Pack quantity	Min. order quantity	Article Number	EAN Code
Cut C Sleeves - 40cm	C	Black	1	1	4932478584	4058546347772
Cut C Sleeves - 45cm	C	Black	1	1	4932478585	4058546347789

Cut E Sleeves

NEW

- High stretch nylon material with 4-way stretch points to fit users' arms.
- Tapered design, wider on the bicep and tight on the wrist, to fit the natural arm form.
- Elastic band with non-slip dots on the bicep and stretch wrist cuff to keep the sleeves in place and prevent them from sagging.
- Breathable and lightweight material provides good dexterity and all-day comfort.
- Elastic thumb loop avoids pressure points when using gloves.
- European Certified for cut protection: EN ISO 21420, EN388:2016 (3X42E), UKCA.



Description	Cut level	Colour code	Pack quantity	Min. order quantity	Article Number	EAN Code
Cut E Sleeves - 40cm	E	Red	1	1	4932479936	4058546377304
Cut E Sleeves - 45cm	E	Red	1	1	4932479937	4058546377311

Winter cut resistant gloves

Description	Colour code	Size	Pack quantity	Min. order quantity	Article Number	EAN Code
① Winter Cut A Gloves	White	7 / S	1	1	4932479704	4058546374983
		7 / S	12	1	4932479705	4058546374990
		7 / S	72	1	4932479706	4058546375003
		8 / M	1	1	4932471343	4058546289713
		8 / M	12	1	4932471606	4058546295059
		8 / M	72	1	4932479000	4058546362904
		9 / L	1	1	4932471344	4058546289720
		9 / L	12	1	4932471607	4058546295066
		9 / L	72	1	4932479001	4058546362911
		10 / XL	1	1	4932471345	4058546289737
		10 / XL	12	1	4932471608	4058546295073
		10 / XL	72	1	4932479002	4058546362928
		11 / XXL	1	1	4932471346	4058546289744
		11 / XXL	12	1	4932471609	4058546295080
		11 / XXL	72	1	4932479003	4058546362935
② Winter Cut B Gloves	Blue	7 / S	1	1	4932480601	4058546408862
		7 / S	12	1	4932480606	4058546408916
		8 / M	1	1	4932480602	4058546408879
		8 / M	12	1	4932480607	4058546408923
		9 / L	1	1	4932480603	4058546408886
		9 / L	12	1	4932480608	4058546408930
		10 / XL	1	1	4932480604	4058546408893
		10 / XL	12	1	4932480609	4058546408947
		11 / XXL	1	1	4932480605	4058546408909
		11 / XXL	12	1	4932480610	4058546408954
③ Winter Cut C Gloves	Black	7 / S	1	1	4932479707	4058546375010
		7 / S	12	1	4932479708	4058546375027
		7 / S	72	1	4932479709	4058546375034
		8 / M	1	1	4932471347	4058546289751
		8 / M	12	1	4932471610	4058546295097
		8 / M	72	1	4932479004	4058546362942
		9 / L	1	1	4932471348	4058546289768
		9 / L	12	1	4932471611	4058546295103
		9 / L	72	1	4932479005	4058546362959
		10 / XL	1	1	4932471349	4058546289775
		10 / XL	12	1	4932471612	4058546295110
		10 / XL	72	1	4932479006	4058546362966
④ Winter Cut D Gloves	Grey	11 / XXL	1	1	4932471350	4058546289782
		11 / XXL	12	1	4932471613	4058546295127
		11 / XXL	72	1	4932479007	4058546362973
		7 / S	1	1	4932480611	4058546408961
		7 / S	12	1	4932480616	4058546409012
		8 / M	1	1	4932480612	4058546408978
		8 / M	12	1	4932480617	4058546409029
		9 / L	1	1	4932480613	4058546408985
		9 / L	12	1	4932480618	4058546409036
		10 / XL	1	1	4932480614	4058546408992
⑤ Winter cut E gloves	Red	10 / XL	12	1	4932480619	4058546409043
		11 / XXL	1	1	4932480615	4058546409005
		11 / XXL	12	1	4932480620	4058546409050
		7 / S	1	1	4932479710	4058546375041
		7 / S	12	1	4932479711	4058546375058
		8 / M	1	1	4932479558	4058546373528
		8 / M	12	1	4932479562	4058546373566
		9 / L	1	1	4932479559	4058546373535
		9 / L	12	1	4932479563	4058546373573
		10 / XL	1	1	4932479560	4058546373542
		10 / XL	12	1	4932479564	4058546373580
		11 / XXL	1	1	4932479561	4058546373559
11 / XXL	12	1	4932479565	4058546373597		

①



②



③



④



⑤



High visibility cut resistant gloves

Description	Colour code	Size	Pack quantity	Min. order quantity	Article Number	EAN Code
① Hi-vis Cut A Gloves	White	7 / S	1	1	4932479916	4058546377106
		8 / M	1	1	4932479917	4058546377113
		9 / L	1	1	4932479918	4058546377120
		10 / XL	1	1	4932479919	4058546377137
		11 / XXL	1	1	4932479920	4058546377144
② Hi-Vis Cut B Gloves	Blue	7 / S	1	1	4932479921	4058546377151
		8 / M	1	1	4932479922	4058546377168
		9 / L	1	1	4932479923	4058546377175
		10 / XL	1	1	4932479924	4058546377182
		11 / XXL	1	1	4932479925	4058546377199
③ Hi-vis Cut C Gloves	Black	7 / S	1	1	4932479721	4058546375157
		7 / S	144	1	4932479722	4058546375164
		8 / M	1	1	4932478131	4058546340643
		8 / M	144	1	4932479020	4058546363109
		9 / L	1	1	4932478132	4058546340650
		9 / L	144	1	4932479021	4058546363116
		10 / XL	1	1	4932478133	4058546340667
		10 / XL	144	1	4932479022	4058546363123
		11 / XXL	1	1	4932478134	4058546340674
11 / XXL	144	1	4932479023	4058546363130		
④ Hi-Vis Cut D Gloves	Grey	7 / S	1	1	4932479926	4058546377205
		8 / M	1	1	4932479927	4058546377212
		9 / L	1	1	4932479928	4058546377229
		10 / XL	1	1	4932479929	4058546377236
		11 / XXL	1	1	4932479930	4058546377243
⑤ Hi-Vis Cut E Gloves	Red	7 / S	1	1	4932479931	4058546377250
		8 / M	1	1	4932479932	4058546377267
		9 / L	1	1	4932479933	4058546377274
		10 / XL	1	1	4932479934	4058546377281
		11 / XXL	1	1	4932479935	4058546377298

①



②



③



④



⑤



Hi-Dexterity Gloves

NEW

Description	Colour code	Size	Pack quantity	Min. order quantity	Article Number	EAN Code
① Hi-Dex Cut B Gloves	Blue	7 / S	1	1	4932480491	4058546407766
		7 / S	12	1	4932480506	4058546407919
		8 / M	1	1	4932480492	4058546407773
		8 / M	12	1	4932480507	4058546407926
		9 / L	1	1	4932480493	4058546407780
		9 / L	12	1	4932480508	4058546407933
		10 / XL	1	1	4932480494	4058546407797
		10 / XL	12	1	4932480509	4058546407940
		11 / XXL	1	1	4932480495	4058546407803
		11 / XXL	12	1	4932480510	4058546407957
② Hi-Dex Cut C Gloves	Black	7 / S	1	1	4932480496	4058546407810
		7 / S	12	1	4932480511	4058546407964
		8 / M	1	1	4932480497	4058546407827
		8 / M	12	1	4932480512	4058546407971
		9 / L	1	1	4932480498	4058546407834
		9 / L	12	1	4932480513	4058546407988
		10 / XL	1	1	4932480499	4058546407841
		10 / XL	12	1	4932480514	4058546407995
		11 / XXL	1	1	4932480500	4058546407858
		11 / XXL	12	1	4932480515	4058546408008
③ Hi-Dex Cut D Gloves	Grey	7 / S	1	1	4932480501	4058546407865
		7 / S	12	1	4932480516	4058546408015
		8 / M	1	1	4932480502	4058546407872
		8 / M	12	1	4932480517	4058546408022
		9 / L	1	1	4932480503	4058546407889
		9 / L	12	1	4932480518	4058546408022
		10 / XL	1	1	4932480504	4058546407896
		10 / XL	12	1	4932480519	4058546408046
		11 / XXL	1	1	4932480505	4058546407902
		11 / XXL	12	1	4932480520	4058546408053



Hybrid leather gloves

- Smartswipe™ - Allows the use of touch screen devices without removing the gloves on the index finger knuckle.
- Leather on the palm for extended durability and reinforced protection of hands.
- Synthetic leather on back of the hand to offer more dexterity and breathability while working.
- Reinforced palm for added comfort and protection while handling heavy objects.
- European Certified for cut resistance protection: EN ISO 21420 and EN388:2016 (2122X).



Description	Pack quantity	Min. order quantity	Article Number	EAN Code
Hybrid Leather Gloves - 7/S - 1pc	1	1	4932479726	4058546375201
Hybrid Leather Gloves - 8/M - 1pc	1	1	4932471912	4058546298111
Hybrid Leather Gloves - 9/L - 1pc	1	1	4932471913	4058546298128
Hybrid Leather Gloves - 10/XL - 1pc	1	1	4932471914	4058546298135
Hybrid Leather Gloves - 11/XXL - 1pc	1	1	4932471915	4058546298142



Gloves Leather Gloves

- Top grain goatskin leather gives extended durability and reinforced protection of hands.
- Reinforced palm provides added comfort and protection while handling heavy objects.
- Keystone thumb for comfortable fit and extended wear.
- Smartswipe™ - Allows the use of touch screen devices without removing the gloves on the index finger knuckle.
- European Certified for cut resistance protection: EN ISO 21420 and EN388:2016 (2122X).



Description	Pack quantity	Min. order quantity	Article Number	EAN Code
Leather Gloves - 7/S - 1pc	1	1	4932479727	4058546375218
Leather Gloves - 8/M - 1pc	1	1	4932478123	4058546340568
Leather Gloves - 9/L - 1pc	1	1	4932478124	4058546340575
Leather Gloves - 10/XL - 1pc	1	1	4932478125	4058546340582
Leather Gloves - 11/XXL - 1pc	1	1	4932478126	4058546340599



Winter Demolition Gloves

- Winter insulation and dual acrylic liner to keep the hand warm while working in cold conditions.
- Water and windproof layer on the palm provide superior insulation in extreme environments.
- Padded palm and fingertips for increased durability and comfort.
- SMARTSWIPE™ index finger knuckle that allows to use touch screen devices without removing gloves or using dirty fingertips.
- Built in sweat wipe with terry cloth on the thumb, to easily clean the glasses.
- European Certified for cut and cold resistance protection: EN ISO 21420, EN388:2016 (2122A), EN511 (14X), UKCA.



Description	Pack quantity	Min. order quantity	Article Number	EAN Code
Winter Demolition Gloves - 7/S - 1pc	1	1	4932479731	4058546375256
Winter Demolition Gloves - 8/M - 1pc	1	1	4932479566	4058546373603
Winter Demolition Gloves - 9/L - 1pc	1	1	4932479567	4058546373610
Winter Demolition Gloves - 10/XL - 1pc	1	1	4932479568	4058546373627
Winter Demolition Gloves - 11/XXL - 1pc	1	1	4932479569	4058546373634
Winter Demolition Gloves - 12/XXXL - 1pc	1	1	4932480976	4058546412616



Impact Cut C Gloves

- Impact resistant material on back of the hand and fingers reduces and absorbs shock.
- Reinforced nitrile coating with added protection between thumb and fingers.
- Excellent grip performance - nitrile material performs better than other materials in extreme temperatures and oily surfaces.
- SMARTWIPE[™] palm and fingertips - allows the use of touch screen devices without removing gloves.
- European Certified for cut resistance protection including impact testing: EN ISO 21420 and EN388:2016 (4343CP).



Description	Pack quantity	Min. order quantity	Article Number	EAN Code
Impact Cut C Gloves - 7/S - 1pc	1	1	4932479724	4058546375188
Impact Cut C Gloves - 8/M - 1pc	1	1	4932478127	4058546340605
Impact Cut C Gloves - 9/L - 1pc	1	1	4932478128	4058546340612
Impact Cut C Gloves - 10/XL - 1pc	1	1	4932478129	4058546340629
Impact Cut C Gloves - 11/XXL - 1pc	1	1	4932478130	4058546340636



Impact Cut E Gloves

- Impact resistant material on back of the hand and fingers reduces and absorbs shocks.
- Double layer of nitrile for added durability and increased protection from sharp objects.
- Reinforced nitrile coating with added protection between thumb and fingers.
- Excellent grip performance - nitrile material performs better than other materials in extreme temperatures and oily surfaces.
- SMARTWIPE[™] palm and fingertips - allows the use of touch screen devices without removing gloves.
- European Certified for cut resistance protection including impact testing: EN ISO 21420 and EN388:2016 (4X44EP).



Description	Pack quantity	Min. order quantity	Article Number	EAN Code
Impact Cut E Gloves - 7/S - 1pc	1	1	4932479725	4058546375195
Impact Cut E Gloves - 8/M - 1pc	1	1	4932479570	4058546373641
Impact Cut E Gloves - 9/L - 1pc	1	1	4932479571	4058546373658
Impact Cut E Gloves - 10/XL - 1pc	1	1	4932479572	4058546373665
Impact Cut E Gloves - 11/XXL - 1pc	1	1	4932479573	4058546373672



Impact demolition gloves

- Impact resistant material, on back of hand and fingers, to reduce and absorb shock.
- ARMORTEX[™] reinforced palms and finger tips: Increased durability and hand protection.
- Superior palm grip on oily and wet surfaces.
- European Certified for cut resistance protection including impact testing: EN ISO 21420 and EN388:2016 (2121XP).



Description	Pack quantity	Min. order quantity	Article Number	EAN Code
Impact Demolition Gloves - 7/S - 1pc	1	1	4932479723	4058546375171
Impact Demolition Gloves - 8/M - 1pc	1	1	4932471908	4058546298074
Impact Demolition Gloves - 9/L - 1pc	1	1	4932471909	4058546298081
Impact Demolition Gloves - 10/XL - 1pc	1	1	4932471910	4058546298098
Impact Demolition Gloves - 11/XXL - 1pc	1	1	4932471911	4058546298104



Demolition gloves

- ARMORTEX™ reinforced palms and finger tips: Increased durability and hand protection.
- SMARTSWIPE™ Knuckle: Capacitive knuckle allows to use touch screen devices without removing gloves or using dirty fingertips.
- Breathable tri-cot lining: Provides ultimate comfort and breathability.
- Knuckle protection: TPR pad provides knuckle protection.
- Terry cloth thumb: Built in sweat/brow wipe.
- Hook & Loop closure for secure fit.
- European Certified: CE Category 2, EN ISO 21420 and EN 388 (2121X).



Description	Pack quantity	Min. order quantity	Article Number	EAN Code
Demolition Gloves - 7/S - 1pc	1	1	4932479730	4058546375249
Demolition Gloves - 8/M - 1pc	1	1	48229731	045242479436
Demolition Gloves - 9/L - 1pc	1	1	48229732	045242479443
Demolition Gloves - 10/XL - 1pc	1	1	48229733	045242479450
Demolition Gloves - 11/XXL - 1pc	1	1	48229734	045242479467



Fingerless gloves

- Designed to provide ultimate dexterity when handling small objects.
- Reinforced palm and thumb seam.
- Lightweight, breathable backing.
- Moisture wicking lining provides all day comfort.
- Built-in sweat wipe.
- Hook & Loop closure for secure fit.
- European Certified: CE Category 2, EN ISO 21420 and EN 388 (2121X).



Description	Pack quantity	Min. order quantity	Article Number	EAN Code
Fingerless Gloves - 7/S - 1pc	1	1	4932479728	4058546375225
Fingerless Gloves - 8/M - 1pc	1	1	48229741	045242508730
Fingerless Gloves - 9/L - 1pc	1	1	48229742	045242508747
Fingerless Gloves - 10/XL - 1pc	1	1	48229743	045242508754
Fingerless Gloves - 11/XXL - 1pc	1	1	48229744	045242508761



Free-Flex Gloves

- SMARTSWIPE™ knuckle, palm and fingertips.
- Flexible and elastic gloves.
- Lightweight, breathable backing.
- Reinforced thumb seam.
- High dexterity finger tips.
- Built-in sweat wipe.
- European Certified: CE Category 2, EN ISO 21420 and EN 388 (2121X).



Description	Pack quantity	Min. order quantity	Article Number	EAN Code
Free-Flex Work Gloves - 7/S - 1pc	1	1	4932479729	4058546375232
Free-Flex Work Gloves - 8/M - 1pc	1	1	48229711	045242508693
Free-Flex Work Gloves - 9/L - 1pc	1	1	48229712	045242508709
Free-Flex Work Gloves - 10/XL - 1pc	1	1	48229713	045242508716
Free-Flex Work Gloves - 11/XXL - 1pc	1	1	48229714	045242508723



TOOL DROP PREVENTION

MILWAUKEE[®] LANYARDS



LOCKING TOOL LANYARDS

WRIST TOOL LANYARD



NAME	4.5 KG LOCKING TOOL LANYARD	4.5 KG QUICK CONNECT LOCKING TOOL LANYARD	6.8 KG LOCKING TOOL LANYARD	15.8 KG LOCKING TOOL LANYARD	WRIST LANYARD	QUICK CONNECT WRIST LANYARD
PART NUMBER	4932471351	4932471429	4932471352	4932471353	4932472107	4932472108
WEIGHT CAPACITY	4.5 KG	4.5 KG	6.8 KG	15.8 KG	2.2 KG	2.2 KG
COLOUR CODING	RED	RED	BLACK	GREY	WHITE	WHITE
TETHER MECHANISM						
COMPATIBLE WITH	ANCHORING STRAP	ALL ACCESSORIES	ANCHORING STRAP	ANCHORING STRAP	-	-
INTEGRATED SWIVEL	✓	✓	✓	✓	-	-
SUITABLE PRODUCTS*	DRILL DRIVER IMPACT DRIVER IMPACT WRENCH JIGSAW HACKZALL SAWZALL [™] SHEARS	HANDTOOLS WITH LANYARD ACCESSORY ATTACHED	ANGLE GRINDER DRILL DRIVER IMPACT DRIVER IMPACT WRENCH SDS PLUS HACKZALL SAWZALL [™] BANDSAWS	SDS PLUS SDS MAX MAG PRESS IMPACT WRENCH BANDSAWS CHAINSAW	DRILL DRIVERS IMPACT DRIVERS IMPACT WRENCH HANDTOOLS	DRILL DRIVERS IMPACT DRIVERS IMPACT WRENCH HANDTOOLS

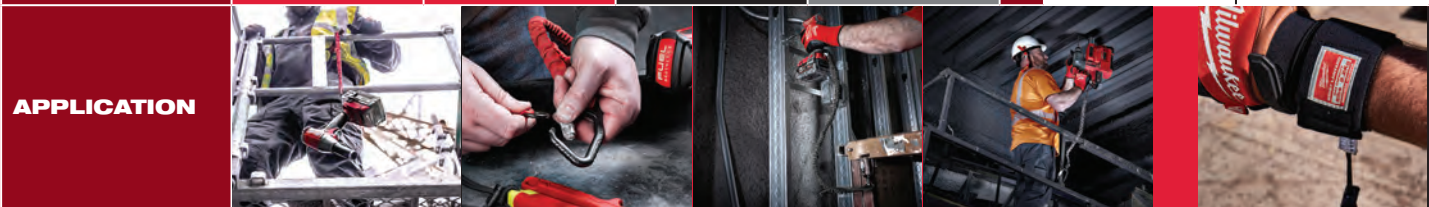

*All product recommendations are only references and are not guaranteed!
Please make sure that the total weight of the tethered product (+ Battery) does not exceed the weight capacity of the tool lanyard!



WHY MILWAUKEE® LANYARDS?

A **FALLING OBJECT** IS THE **3RD HIGHEST** CAUSE OF **FATALITY** ON A JOBSITE.

(Peoplesafe.co.uk, 2019)

RETRACTABLE TOOL LANYARD



TOOL LANYARD ACCESSORIES



QUICK CONNECT RETRACTABLE TOOL LANYARD	ANCHORING STRAP	D-RING WEB	SMALL QUICK CONNECT	SPLIT RINGS 38 mm / 50 mm	SELF-ADHERING TAPE 3.6 m
4932472106	4932472105	4932471431	4932471430	4932471433 (38 mm) 4932471434 (50 mm)	48228860
2.2 KG	22.7 KG	2.2 KG	2.2 KG	1 KG	-
WHITE	GREEN	WHITE	WHITE	-	-
				-	-
ALL ACCESSORIES	ALL LOCKING TOOL LANYARDS	SELF-ADHERING TAPE & 4.5 KG QUICK CONNECT LOCKING TOOL LANYARD	4.5 KG QUICK CONNECT LOCKING TOOL LANYARD	4.5 KG QUICK CONNECT LOCKING TOOL LANYARD	D-RING WEB
✓	-	-	-	-	-
DRILL DRIVERS IMPACT DRIVERS IMPACT WRENCH HANDTOOLS	ALL LOCKING TOOL LANYARDS	HANDTOOLS WITHOUT LANYARD HOLE HAMMERS CUTTERS PLIERS	HANDTOOLS WITH LANYARD HOLE SCREWDRIVERS TAPES PLIERS	HANDTOOL WITH LANYARD HOLE KNIVES TAPES PLIERS	D-RING WEB



Locking tool lanyards

- Superior shock absorption - gradually stop the tool if dropped.
- Double locking carabiner - ensures a secure connection that cannot become loose or slip off accidentally.
- Integrated swivel - prevents twists and tangles allowing increased mobility.
- Colour coded weight rating - easy identification of lanyard weight capacity.
- High versatility - lanyard accessories can be added to connect all tools to the lanyards.

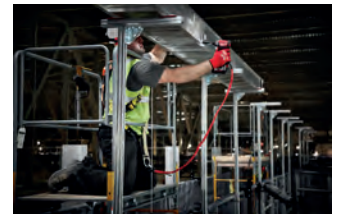

Description	Bearing force (kg)	Colour code	Pack quantity	Min. order quantity	Article Number	EAN Code
① 4.5 kg locking tool lanyard	4.5	Red	1	1	4932471351	4058546289799
② 4.5 kg QUICK-CONNECT™ locking tool lanyard	4.5	Red	1	1	4932471429	4058546290573
③ 6.8 kg locking tool lanyard	6.8	Black	1	1	4932471352	4058546289805
④ 15.8 kg locking tool lanyard	15.8	Grey	1	1	4932471353	4058546289812



TOOL LANYARD ACCESSORIES

STAY SAFE. SECURE ANY TOOL.



EASILY CONNECT

- Creates a secure attachment point
- Different connection system (self-adhering tape or rings)

HIGH VERSATILITY

- Possibility to connect tools with or without lanyard holes
- Allows fast tool swap

Tool lanyard accessories

Description	Colour code	Bearing force (kg)	Pack quantity	Min. order quantity	Article Number	EAN Code
① 2.2 kg small QUICK-CONNECT™ accessory	White	2.2	3	1	4932471430	4058546290580
② 2.2 kg D-ring web attachment	White	2.2	5	1	4932471431	4058546290597
③ 3.6 m self-adhering tape	-	-	1	1	48228860	4058546290603
④ 38 mm split ring	-	1	5	1	4932471433	4058546290610
⑤ 50 mm split ring	-	1	5	1	4932471434	4058546290627
⑥ Anchoring strap	Green	22.7	1	1	4932472105	4058546325015

Retractable tool lanyard

- Automatically retracts, 127 cm when extended.
- Double locking carabiner - ensures a secure connection that cannot become loose or slip off accidentally.
- Shuttle lock - greater control during use.
- Integrated swivel - prevents twists and tangles allowing increased mobility.
- Colour coded weight rating - easy identification of lanyard weight capacity.
- High versatility - lanyard accessories can be added to connect all tools to the lanyards.



Description	Colour code	Pack quantity	Min. order quantity	Article Number	EAN Code
2.2 kg Quick-Connect Retractable Tool Lanyard	White	1	1	4932472106	4058546325022

Wrist tool lanyard

- Secure and comfortable tools attachment to the wrist.
- Soft and adjustable strap - fits all wrist sizes with a hook and loop closure.
- Hang loop or quick-connect double locking carabiner to securely attach all kind of tools - power tools, tapes, screwdrivers, etc.
- Wrist lanyard allows an easy access to tools in a tight environment or in repetitive work.
- Colour coded weight rating - easy identification of lanyard weight capacity.



Description	Bearing force (kg)	Colour code	Pack quantity	Min. order quantity	Article Number	EAN Code
① Wrist lanyard	2.2	White	1	1	4932472107	4058546325039
② Quick connect wrist lanyard	2.2	White	1	1	4932472108	4058546325046



Nothing but **HEAVY DUTY.**[™]



MACHINE WASHABLE



UP TO 8 HOURS* OF CONTINUOUS HEAT



TOUCH SENSITIVE CONTROLS

MILWAUKEE HEATED GEAR RANGE

Powered by M12[™] REDLITHIUM[™] or REDLITHIUM[™] USB battery technology, MILWAUKEE[®] Heated Work Gear distributes heat across core body areas. Durable carbon fibre heating elements maintain heat to reduce the need for bulky layers, while multiple heat settings allow the user to select the right amount of warmth for all weather conditions. Our range of heated work wear is fully machine washable and dryable for extended use.

*on a single battery charge (3.0 Ah) at low setting

EXPLORE OUR RANGE OF HEATED GEAR

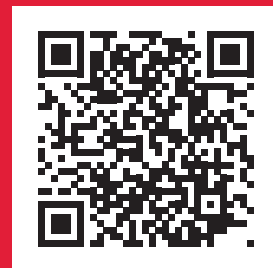

M12™ heated jacket - Black

- Heat on demand - sewn in carbon fibre heating wires, distribute heat to core body areas and to the front pockets
- Superior run time, up to 8 hours of heat on low level with a single battery charge of an M12™ REDLITHIUM™ 3.0 Ah battery pack
- Easy touch heat controller - 3 heat settings: High, Medium, Low
- TOUGHSHELL™ stretch 90% polyester and 10% spandex material to withstand harsh working conditions and deliver up to 5x longer life
- FREE FLEX™ mobility - additional material under the arms increases range of movement for working overhead
- New battery pocket design providing users multiple options for battery placement, allowing adaptability to the situation
- Improved slim fit design with extended back prevents heat loss and keeps the user warm
- M12™ battery controller with 1 A USB port, to charge mobile devices stored in concealed battery pocket
- Water and wind resistant, provides comfort and durability in harsh environments
- Big hand & chest pocket, ideal for storing mobile devices
- Flexible battery system: works with all MILWAUKEE® M12™ batteries
- Available in sizes S-XXXL
- Machine washable and dryable



Description	Size	Pack quantity	Min. order quantity	Article Number	EAN Code
M12™ heated jacket - Black	S	1	1	4933478967	4058546362492
M12™ heated jacket - Black	M	1	1	4933478968	4058546362508
M12™ heated jacket - Black	L	1	1	4933478969	4058546362515
M12™ heated jacket - Black	XL	1	1	4933478970	4058546362522
M12™ heated jacket - Black	XXL	1	1	4933478971	4058546362539
M12™ heated jacket - Black	XXXL	1	1	4933479362	4058546371562

M12™ heated jacket - Grey

- Heat on demand - sewn in carbon fibre heating wires, distribute heat to core body areas and to the front pockets
- Superior run time, up to 8 hours of heat on low level with a single battery charge of an M12™ REDLITHIUM™ 3.0 Ah battery pack
- Easy touch heat controller - 3 heat settings: High, Medium, Low
- TOUGHSHELL™ stretch 90% polyester and 10% spandex material to withstand harsh working conditions and deliver up to 5x longer life
- FREE FLEX™ mobility - additional material under the arms increases range of movement for working overhead
- New battery pocket design providing users multiple options for battery placement, allowing adaptability to the situation
- Improved slim fit design with extended back prevents heat loss and keeps the user warm
- M12™ battery controller with 1 A USB port, to charge mobile devices stored in concealed battery pocket
- Water and wind resistant, provides comfort and durability in harsh environments
- Big hand & chest pocket, ideal for storing mobile devices
- Flexible battery system: works with all MILWAUKEE® M12™ batteries
- Available in sizes S-XXXL
- Machine washable and dryable



Description	Size	Pack quantity	Min. order quantity	Article Number	EAN Code
M12™ heated jacket - Grey	S	1	1	4933478972	4058546362546
M12™ heated jacket - Grey	M	1	1	4933478973	4058546362553
M12™ heated jacket - Grey	L	1	1	4933478974	4058546362560
M12™ heated jacket - Grey	XL	1	1	4933478975	4058546362577
M12™ heated jacket - Grey	XXL	1	1	4933478976	4058546362584
M12™ heated jacket - Grey	XXXL	1	1	4933479363	4058546371579

M12™ heated camouflage jacket

- REALTREE XTRA™ Camo pattern blends perfectly year round in a variety of habitats
- Quiet-shell stretch 100% polyester material to reduce noise during movement
- Heat on demand - 5 sewn in carbon fibre heating zones distribute heat to core body areas and to the front pockets
- Superior run time, up to 8 hours of heat on low level with a single battery charge of an M12™ REDLITHIUM™ 3.0 Ah battery pack
- Easy touch heat controller concealed inside the lapel - 3 heat settings: High, Medium, Low
- FREE FLEX™ mobility - additional material under the arms increases range of movement for working overhead
- Water and wind resistant, provides comfort and durability in harsh environments
- New battery pocket design providing users multiple options for battery placement, allowing adaptability to the situation
- Improved slim fit design with extended back prevents heat loss and keeps the user warm
- M12™ battery controller with 1 A USB port, to charge mobile devices stored in concealed battery pocket
- Big hand & chest pocket, ideal for storing mobile devices
- Flexible battery system: works with all MILWAUKEE® M12™ batteries
- Available in sizes S-XXXL
- Machine washable and dryable



Description	Size	Pack quantity	Min. order quantity	Article Number	EAN Code
M12™ heated camouflage jacket	S	1	1	4933478977	4058546362591
M12™ heated camouflage jacket	M	1	1	4933478978	4058546362607
M12™ heated camouflage jacket	L	1	1	4933478979	4058546362614
M12™ heated camouflage jacket	XL	1	1	4933478980	4058546362621
M12™ heated camouflage jacket	XXL	1	1	4933478981	4058546362638
M12™ heated camouflage jacket	XXXL	1	1	4933479364	4058546371586

M12™ heated vest - Grey

NEW

- M12™ Heated TOUGHSHELL™ vest powered by an M12™ battery with carbon fibre heating elements creates and distributes heat to chest & back.
- Superior run time, up to 11 hours of heat on a single battery charge of an M12™ 12V REDLITHIUM™ 3 Ah Battery pack.
- TOUGHSHELL™ stretch 90 % Polyester and 10 % spandex material to withstand harsh working conditions.
- Optimized hidden battery pocket to place M12™ battery in front or rear for increased comfort.
- Multiple heating zones - 3 sewn in carbon fibre heating zones distribute heat to core body areas.
- Easy one-touch heat controller - 3 heat settings: High, Medium, Low.
- Machine washable and dryable.
- Battery holder included.
- Flexible battery system: works with all MILWAUKEE®M12™Batteries.



Description	Size	Pack quantity	Min. order quantity	Article Number	EAN Code
M12™heated vest - Grey	S	1	1	4932480100	4058546403850
M12™heated vest - Grey	M	1	1	4932480101	4058546403867
M12™heated vest - Grey	L	1	1	4932480102	4058546403874
M12™heated vest - Grey	XL	1	1	4932480103	4058546403881
M12™heated vest - Grey	XXL	1	1	4932480104	4058546403898
M12™heated vest - Grey	XXXL	1	1	4932480105	4058546403904

M12™ heated puffer jacket - Black

NEW

- M12™ Heated Jacket powered by an M12™ Battery with carbon fibre heating elements creates and distributes heat to chest, back and shoulders.
- Superior run time, up to 11 hours of heat on a single battery charge of an M12™ 12V REDLITHIUM™ 3 Ah battery pack.
- Lightweight and highly durable ripstop polyester provides a slim design that can be worn as an outer-shell or a mid-layer (100 % Polyester outer and inner shell).
- Reinforced high-wear zones protect from abrasion and tears.
- Provides comfort and durability in harsh, rainy or windy environments.
- Optimized hidden battery pocket to place M12™ Battery in front or rear for increased comfort.
- Multiple heating zones - 5 sewn in carbon fibre heating zones distribute heat to core body areas.
- Easy one-touch heat controller - 3 heat settings: High, Medium, Low.
- Machine washable and dryable.
- Battery controller included.
- New hood design.
- Flexible battery system: works with all MILWAUKEE® M12™ Batteries.



Description	Size	Pack quantity	Min. order quantity	Article Number	EAN Code
M12™ heated puffer jacket - Black	S	1	1	4932480071	4058546403560
M12™ heated puffer jacket - Black	M	1	1	4932480072	4058546403577
M12™ heated puffer jacket - Black	L	1	1	4932480073	4058546403584
M12™ heated puffer jacket - Black	XL	1	1	4932480074	4058546403591
M12™ heated puffer jacket - Black	XXL	1	1	4932480075	4058546403607

USB rechargeable heated WORKSKIN™ base layer

- Mid-weight construction out of durable, pilling resistant material, keeps body warm and dry
- Fully heats-up in 2.5 min
- Heat is created and distributed to the chest and back
- Powered by L4 USB rechargeable REDLITHIUM™ battery pack
- A one-touch LED controller allows the user to select from 2 heat settings, delivering ideal heat for any environment
- Durable, pilling resistant material with raglan designed sleeves and seamless shoulders for improved mobility and comfort
- Superior run time – Up to 180 min of heat on low level
- L4 battery holder - concealed battery pocket for minimal user interference
- Machine washable



Description	Size	Pack quantity	Min. order quantity	Article Number	EAN Code
USB rechargeable heated WORKSKIN™ base layer	S	1	1	4933478081	4058546340148
USB rechargeable heated WORKSKIN™ base layer	M	1	1	4933478082	4058546340155
USB rechargeable heated WORKSKIN™ base layer	L	1	1	4933478083	4058546340162
USB rechargeable heated WORKSKIN™ base layer	XL	1	1	4933478084	4058546340179
USB rechargeable heated WORKSKIN™ base layer	XXL	1	1	4933478085	4058546340186

M12[™] heated hoodie - Black

NEW

- M12[™] Heated Hoodie powered by an M12[™] battery with carbon fibre heating elements creates and distributes heat to chest and back.
- Superior run time, up to 11 hours of heat on a single battery charge of an M12[™] 12V REDLITHIUM[™] 3 Ah Battery pack.
- Rugged heated hoodie made from durable cotton (53%) exterior with durable reinforced utility pockets and polyester fleece (47%) lining to withstand tough outdoor conditions.
- Optimized hidden battery pocket to place M12[™] battery in front or rear for increased comfort.
- In autumn and spring the hoodie can be worn as a rugged outer layer. In winter, it is best as a base layer that allows to shed bulky undergarments while generating and holding heat close to the body.
- Multiple heating zones - 3 sewn in carbon fibre heating zones distribute heat to core body areas.
- Easy one-touch heat controller - 3 heat settings: High, Medium, Low.
- Integrated cell phone pocket.
- Machine washable and dryable.
- Battery holder included.
- Flexible battery system: works with all MILWAUKEE[®]M12[™]Batteries.



Description	Size	Pack quantity	Min. order quantity	Article Number	EAN Code
M12 [™] heated hoodie - Black	S	1	1	4932480061	4058546403461
M12 [™] heated hoodie - Black	M	1	1	4932480062	4058546403478
M12 [™] heated hoodie - Black	L	1	1	4932480063	4058546403485
M12 [™] heated hoodie - Black	XL	1	1	4932480064	4058546403492
M12 [™] heated hoodie - Black	XXL	1	1	4932480065	4058546403508

M12[™] heated ladies hoodie - Black

NEW

- M12[™] Heated Hoodie for ladies powered by an M12[™] Battery with carbon fibre heating elements creates and distributes heat to chest and back.
- Superior run time, up to 11 hours of heat on a single battery charge of an M12[™] 12V REDLITHIUM[™] 3 Ah Battery pack.
- Optimized hidden battery pocket to place M12[™] Battery in front or rear for increased comfort.
- Rugged heated hoodie made from durable cotton (53%) exterior with durable reinforced utility pockets and polyester fleece (47%) lining to withstand tough outdoor conditions.
- In autumn and spring the hoodie can be worn as a rugged outer layer. In winter, it is best as a base layer that allows to shed bulky undergarments while generating and holding heat close to the body.
- Multiple heating zones - 3 sewn in carbon fibre heating zones distribute heat to core body areas.
- Easy one-touch heat controller - 3 heat settings: High, Medium, Low.
- Integrated cell phone pocket.
- Machine washable and dryable.
- Battery holder included.
- Flexible battery system: works with all MILWAUKEE[®]M12[™]Batteries.



Description	Size	Pack quantity	Min. order quantity	Article Number	EAN Code
M12 [™] heated ladies hoodie - Black	S	1	1	4932480090	4058546403751
M12 [™] heated ladies hoodie - Black	M	1	1	4932480091	4058546403768
M12 [™] heated ladies hoodie - Black	L	1	1	4932480092	4058546403775
M12 [™] heated ladies hoodie - Black	XL	1	1	4932480093	4058546403782

WORKSKIN™ light weight performance short sleeve shirt - Grey

- Light weight to stay productive on the jobsite in hot weather conditions.
- Moisture wicking fabric, 100 % Polyester.
- Fast-drying, multi-layer mesh material in core sweat zones for great ventilation under the armpits, on the sides of the body and on the back.
- Raglan sleeves for comfortable carrying of tool bags, backpacks or climbing harnesses and providing a greater range of motion.



Description	Size	Pack quantity	Min. order quantity	Article Number	EAN Code
WORKSKIN™ light weight performance short sleeve shirt - Grey	S	1	1	4933478194	4058546341275
WORKSKIN™ light weight performance short sleeve shirt - Grey	M	1	1	4933478195	4058546341282
WORKSKIN™ light weight performance short sleeve shirt - Grey	L	1	1	4933478196	4058546341299
WORKSKIN™ light weight performance short sleeve shirt - Grey	XL	1	1	4933478197	4058546341305
WORKSKIN™ light weight performance short sleeve shirt - Grey	XXL	1	1	4933478198	4058546341312

Work T-shirt short sleeve - Grey

- Tear, abrasion resistant and breathable fabric
- 60/40 cotton-poly blend enables moisture wicking and water repels
- Heavy duty 230 GSM fabric weight



Description	Size	Pack quantity	Min. order quantity	Article Number	EAN Code
Work T-shirt short sleeve - Grey	S	1	1	4933478231	4058546344085
Work T-shirt short sleeve - Grey	M	1	1	4933478232	4058546344092
Work T-shirt short sleeve - Grey	L	1	1	4933478233	4058546344108
Work T-shirt short sleeve - Grey	XL	1	1	4933478234	4058546344115
Work T-shirt short sleeve - Grey	XXL	1	1	4933478235	4058546344122

WORKSKIN[™] light weight performance long sleeve shirt - Grey

- Light weight to stay productive on the jobsite in hot weather conditions.
- Moisture wicking fabric, 100 % Polyester.
- Fast-drying, multi-layer mesh material in core sweat zones for great ventilation under the armpits, on the sides of the body and on the back.
- Raglan sleeves for comfortable carrying of tool bags, backpacks or climbing harnesses and providing a greater range of motion.



Description	Size	Pack quantity	Min. order quantity	Article Number	EAN Code
WORKSKIN [™] light weight performance long sleeve shirt - Grey	S	1	1	4933478188	4058546341213
WORKSKIN [™] light weight performance long sleeve shirt - Grey	M	1	1	4933478189	4058546341220
WORKSKIN [™] light weight performance long sleeve shirt - Grey	L	1	1	4933478190	4058546341237
WORKSKIN [™] light weight performance long sleeve shirt - Grey	XL	1	1	4933478191	4058546341244
WORKSKIN [™] light weight performance long sleeve shirt - Grey	XXL	1	1	4933478192	4058546341251

Work T-shirt long sleeve - Grey

- Tear, abrasion resistant and breathable fabric
- 60/40 cotton-poly blend enables moisture wicking and water repels
- Heavy duty 230 GSM fabric weight
- UPF 30+ rating, blocks harmful UV rays



Description	Size	Pack quantity	Min. order quantity	Article Number	EAN Code
Work T-shirt long sleeve - Grey	S	1	1	4933478237	4058546344146
Work T-shirt long sleeve - Grey	M	1	1	4933478238	4058546344153
Work T-shirt long sleeve - Grey	L	1	1	4933478239	4058546344160
Work T-shirt long sleeve - Grey	XL	1	1	4933478240	4058546344177
Work T-shirt long sleeve - Grey	XXL	1	1	4933478241	4058546344184

Work hoodie black

- Made from durable, breathable fabric for all-day protection to outlast the job
- Built with a tear- and abrasion-resistant 75/25 cotton/poly blend
- The fabric is wind resistant, and has comfortable fit rib-knit cuffs and waists, make these work hoodies great for the most demanding conditions
- Drawstring adjustable hood for perfect comfort
- Reinforced pocket seams, for a longer lifetime



Description	Size	Pack quantity	Min. order quantity	Article Number	EAN Code
Work hoodie black	S	1	1	4933478212	4058546343897
Work hoodie black	M	1	1	4933478213	4058546343903
Work hoodie black	L	1	1	4933478214	4058546343910
Work hoodie black	XL	1	1	4933478215	4058546343927
Work hoodie black	XXL	1	1	4933478216	4058546343934

Neck gaiter & face mask

- Multi-functional, wear it as a neck gaiter, face mask, headband, sweatband or headgear protection on the jobsite
- Moisture wicking fabric dries quickly, repels sweat & water, keeps users dry on the jobsite
- Breathable, comfortable fabric made from 86 % Polyester and 14 % Spandex
- 50+ UPF sun protection blocks 98 % of UV rays
- Shields from wind, dust and jobsite debris
- Turnback hem prevents the fabric from sliding down
- Washer and dryer safe
- One size fits most
- Available in colours grey and red



Description	Colour	Pack quantity	Min. order quantity	Article Number	EAN Code
Neck gaiter & face mask - Red	Red	1	1	4933478780	4058546360627
Neck gaiter & face mask - Grey	Grey	1	1	4933478766	4058546360481

Performance Face Covering

- Structured Fit Design - Separates mask from mouth.
- 3 Soft and Breathable Layers - all day comfort for long time wear.
- Comfortable Adjustable Ear Loops - No pressure on the ears.
- Water Repellent Outer Layer.
- Flexible Nose Bridge - Adjustability for a better sealing and to reduce fog on glasses.
- Moisture Wicking Inner Layer - Stay Cool, Dry Fast.
- Machine Washable.



Description	Size	Pack quantity	Min. order quantity	Article number	EAN Code
Performance Face Covering S/M - 3pcs	S / M	3	1	4932478865	4058546361471
Performance Face Covering L/XL - 3pcs	L / XL	3	1	4932478866	4058546361488

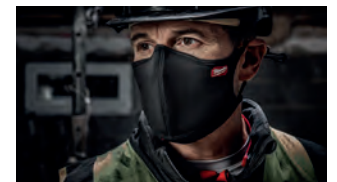

Flexible knee pad

- Flexible, lightweight and comfortable foam padding.
- Water resistant cap.
- Debris guard to prevent debris from entering.
- Size adjustable straps for a custom fit.
- Buckles to quickly put on and off the knee pad.
- European Certified knee protectors: EN 14404 performance level 1.



Description	Pack quantity	Min. order quantity	Article Number	EAN Code
Flexible knee pad - 1 pair	1	1	4932478136	4058546340698

Hard knee pad

- Thick comfortable foam padding with a supporting gel zone.
- Durable hard cap which withstands rough surfaces.
- Size adjustable double straps for a better hold and a custom fit.
- Buckles with metal rivets that withstand repeated fastenings.
- 1680D Ballistic Nylon for a long lifetime.
- European Certified knee protectors: EN 14404 performance level 2.



Description	Pack quantity	Min. order quantity	Article Number	EAN Code
Hard knee pad - 1 pair	1	1	4932478137	4058546340704

Premium non-marking knee pad

- High density foam padding with a supporting premium gel injection.
- Non-marking coating to prevent scratches on sensitive surfaces.
- Comfortable and size adjustable double straps with a wider lower strap.
- Buckles with metal rivets that withstand repeated fastenings.
- 1680D Ballistic Nylon for a long lifetime.
- European Certified knee protectors: EN 14404 performance level 1.



Description	Pack quantity	Min. order quantity	Article Number	EAN Code
Premium non-marking knee pad - 1 pair	1	1	4932478139	4058546340728



MILWAUKEE® STEEL STORAGE





Milwaukee

Milwaukee

Milwaukee

Milwaukee

30" / 78 cm 7-Drawer Steel Storage Rolling Cabinet

- 45 kg rated soft-close drawers.
- Bottom drawer rated at 90 kg.
- Anti-tilt protection allows only 1 drawer to be open at a time.
- Each drawer supplied with anti-slip mat inlay.
- Recessed ABS worktop with screwdriver holes and additional compartments.
- ABS corner bumpers prevent damages when moved around the garage.
- Magnetic power strip allows to charge batteries directly on the cabinet.
- Peg board with hooks and tool holders for an easy access to the most used tools.
- Additional side shelves for bottles and cans.
- Power tool organiser in the bottom drawer.
- 125 mm industrial casters (2x fixed, 2x swiveling with brakes).
- 800 kg total weight capacity.



Description	Dimensions (mm)	Pack quantity	Min. order quantity	Article Number	EAN Code
30" / 78 cm 7-Drawer Steel Storage Rolling Cabinet	810 x 524 x 1064	1	1	4932478849	4058546361310

30" / 78 cm 4-Drawer Steel Storage Top Chest

- 45 kg rated soft-close drawers.
- Anti-tilt protection allows only 1 drawer to be open at a time.
- Each drawer supplied with anti-slip mat inlay.
- ABS corner bumpers prevent damages when moved around the garage.
- Additional side shelves for bottles and cans.



Description	Dimensions (mm)	Pack quantity	Min. order quantity	Article Number	EAN Code
30" / 78 cm 4-Drawer Steel Storage Top Chest	810 x 524 x 498	1	1	4932478850	4058546361327

40" / 102 cm Steel Work Cart

- 45 kg rated soft-close drawers.
- 90 kg rated sliding bottom shelf.
- Built-in storage compartments.
- 2 removable storage cups, which can be flipped upside down to create a flush surface or completely removed for vertical long tool storage.
- V-grooves to hold material when cutting or measuring.
- Foldable rear shelf with 22 kg weight capacity.
- 2 moveable shelves for storing bottles, sprays and other equipment.
- Rubber corner bumpers prevent damages when moved around the garage.
- Magnetic power strip allows to charge batteries directly on the cart.
- 125 mm industrial casters (2x fixed, 2x swiveling with brakes).
- 315 kg total weight capacity.



Description	Dimensions (mm)	Pack quantity	Min. order quantity	Article Number	EAN Code
40" / 102 cm Steel Work Cart	1016 x 561 x 991	1	1	4932478856	4058546361389

46" / 117 cm High Capacity 10-Drawer Steel Storage Rolling Cabinet

- 45 kg rated soft-close drawers.
- Bottom drawers rated at 90 kg.
- Each drawer supplied with anti-slip mat inlay.
- Rubber corner bumpers prevent damages when moved around the garage.
- Magnetic power strip allows to charge batteries directly on the cabinet.
- Foldable side shelf for bottles and cans.
- Integrated bottle opener.
- Power tool organiser in the bottom drawer.
- 150 mm industrial casters (2x fixed, 2x swiveling with brakes).
- 1360 kg total weight capacity.



Description	Dimensions (Outer)(H x W x D / mm)	Pack quantity	Min. order quantity	Article Number	EAN Code
46" / 117 cm High Capacity 10-Drawer Steel Storage Rolling Cabinet	1170 x 562 x 982	1	1	4932478852	4058546361341

46" / 117 cm High Capacity 6-Drawer Steel Storage Top Chest

- 45 kg rated soft-close drawers.
- Each drawer supplied with anti-slip mat inlay.
- Work top drawer for writing or using a laptop.
- Independent locking safety drawer to securely store valuable items (phone, keys, documents).
- Rubber corner bumpers prevent damages when moved around the garage.
- Magnetic power strip allows to charge batteries directly on the chest.
- Peg board with hooks on the back wall for an easy access to the most used tools.



Description	Dimensions (mm)	Pack quantity	Min. order quantity	Article Number	EAN Code
46" / 117 cm High Capacity 6-Drawer Steel Storage Top Chest	1170 x 562 x 644	1	1	4932478854	4058546361365

STEEL STORAGE FOAM INSERTS

CONVENIENT RECESSES

Easy and quick removal of tools

RED BACKGROUND

Immediate identification of missing tools

LASER CUT SIZE LABELS

Easy, quick size identification

PREMIUM FOAM

35 kg/m³ density of foam improves durability and resistance to abrasion.



SCAN TO VIRTUALLY CUSTOMISE YOUR STEEL STORAGE DRAWERS

Trilobe Screwdriver Foam Insert

- Comfortable Tri-Lobe handle optimized for maximum user comfort and high torque applications.
- Hardened magnetic tips for maximum durability and fastener retention.
- Wrench ready shank allows extra leverage to be applied.
- Anti-roll, 3 sided collar on the handle.

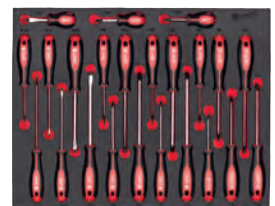

Description	Pack quantity	Min. order quantity	Article Number	EAN Code
Trilobe Screwdriver Foam Insert	23	1	4932479830	4058546376246
SL 2.5 / SL 3 / SL 4 / SL 5.5 / SL 6 / SL 6.5 / SL 8, PH 0 / PH 1 / PH 2 / PH 2 / PH 3, PZ 0 / PZ 1 / PZ 2 / PZ 2 / PZ 3, T 10 / T 15 / T 20 / T 25 / T 30 / T 40				

Tri-lobe Screwdriver Torx Sets Foam Inserts

NEW

- Comfortable Tri-Lobe handle optimized for maximum user comfort and high torque applications
- Hardened magnetic tips for maximum durability and fastener retention
- Wrench ready shank allows extra leverage to be applied
- Anti-roll, 3 sided collar on the handle

Description	Pack quantity	Min. order quantity	Article Number	EAN Code
7 pc Tri-Lobe Screwdriver TX Set 1 Foam Insert				
① T7x65, T8x65, T9x75, T10x75, T15x75, T20x100, T25x100	7	1	4932492391	4058546417581
6 pc Tri-Lobe Screwdriver TX Set 2 Foam Insert				
② T10x75, T15x75, T20x100, T25x100, T30x125, T40x125	6	1	4932492392	4058546417598

①



②



Tri-lobe Screwdriver Phillips Set Foam Insert

NEW

- Comfortable Tri-Lobe handle optimized for maximum user comfort and high torque applications
- Hardened magnetic tips for maximum durability and fastener retention
- Wrench ready shank allows extra leverage to be applied
- Anti-roll, 3 sided collar on the handle



Description	Pack quantity	Min. order quantity	Article Number	EAN Code
5 pc Tri-Lobe Screwdriver PH Set Foam Insert PH0x75, PH1x100, PH2x125, PH3x150, Stubby PH2x45	5	1	4932492393	4058546417604

Tri-lobe Screwdriver Slotted & Phillips Set Foam Insert

NEW

- Comfortable Tri-Lobe handle optimized for maximum user comfort and high torque applications
- Hardened magnetic tips for maximum durability and fastener retention
- Wrench ready shank allows extra leverage to be applied
- Anti-roll, 3 sided collar on the handle



Description	Pack quantity	Min. order quantity	Article Number	EAN Code
7 pc Tri-Lobe Screwdriver SL & PH Set Foam Insert SL 0.5x3x75, SL 0.8x4x100, SL 1.0x5.5x125, SL 1.2x6.5x125, PH0x75, PH1x100, PH2x125	7	1	4932492394	4058546417611

Tri-lobe Screwdriver Slotted Set Foam Insert

NEW

- Comfortable Tri-Lobe handle optimized for maximum user comfort and high torque applications
- Hardened magnetic tips for maximum durability and fastener retention
- Wrench ready shank allows extra leverage to be applied
- Anti-roll, 3 sided collar on the handle



Description	Pack quantity	Min. order quantity	Article Number	EAN Code
7 pc Tri-Lobe Screwdriver SL Set Foam Insert SL 0.5x3x75, SL 0.6 x 3.5 x 100, SL 0.8x4x100, SL 1.0x5.5x125, SL 1.2x6.5x125, SL 1.6x8x175, Stubby SL 1.2x6.5x45	7	1	4932492395	4058546417628

1/4" Ratchet and Socket Set Foam Insert

- 90 tooth design with 4 ° of arc swing for tight work spaces.
- FOUR FLAT™ sides on socket deter rolling.
- All metal design for maximum durability.



Description	Pack quantity	Min. order quantity	Article Number	EAN Code
1/4" Ratchet and Socket Set Foam Insert Standard sockets: 5 mm, 5.5 mm, 6 mm, 7 mm, 8 mm, 9 mm, 10 mm, 11 mm, 12 mm, 13 mm, 14 mm, 15 mm / Deep well sockets: 5 mm, 5.5 mm, 6 mm, 7 mm, 8 mm, 9 mm, 10 mm, 11 mm, 12 mm, 13 mm, 14 mm, 15 mm / 76 mm extension, 152 mm extension, universal joint	28	1	4932479824	4058546376185



Nothing but **HEAVY DUTY.**[™]

3/8" Ratchet and Socket Set Foam Insert

- 90 tooth design with 4 °of arc swing for tight work spaces.
- FOUR FLAT[™] sides on socket deter rolling.
- All metal design for maximum durability.

Description	Pack quantity	Min. order quantity	Article Number	EAN Code
3/8" Ratchet and Socket Set Foam Insert	32	1	4932479825	4058546376192
Standard sockets: 6 mm, 7 mm, 8 mm, 9 mm, 10 mm, 11 mm, 12 mm, 13 mm, 14 mm, 15 mm, 16 mm, 17 mm, 18 mm, 19 mm / Deep well sockets: 6 mm, 7 mm, 8 mm, 9 mm, 10 mm, 11 mm, 12 mm, 13 mm, 14 mm, 15 mm, 16 mm, 17 mm, 18 mm, 19 mm / 76 mm extension, 152 mm extension / Universal joint				



1/2" Ratchet and Socket Set Foam Insert

- 90 tooth design with 4 °of arc swing for tight work spaces.
- FOUR FLAT[™] sides on socket deter rolling.
- All metal design for maximum durability.

Description	Pack quantity	Min. order quantity	Article Number	EAN Code
1/2" Ratchet and Socket Set Foam Insert	28	1	4932479826	4058546376208
Standard sockets: 10 mm, 11 mm, 12 mm, 13 mm, 14 mm, 15 mm, 16 mm, 17 mm, 18 mm, 19 mm, 20 mm, 21 mm, 22 mm, 23 mm, 24 mm / Deep well sockets: 10 mm, 11 mm, 12 mm, 13 mm, 14 mm, 15 mm, 16 mm, 17 mm, 18 mm, 19 mm / 76 mm extension, 127 mm extension				



MAX BITE[™] Flex Head Ratcheting Spanner Set Foam Insert

- 180° pivoting head for greater access to tight spaces.
- MAX BITE[™] open-end grip reduces rounding and stripping.
- 144 ratcheting teeth positions giving 2.5° arc swing allowing access in tighter spaces.
- Durable double stacked pawls for longer ratchet life.
- Rounded I-Beam handle for comfortable handling grip.

Description	Pack quantity	Min. order quantity	Article Number	EAN Code
MAX BITE [™] Flex Head Ratcheting Spanner Set Foam Insert	15	1	4932479829	4058546376239
8, 9, 10, 11, 12, 13, 14, 15, 16, 17, 18, 19, 20, 21, 22 mm				



MAX BITE[™] Combination Spanner Set Foam Insert

- MAX BITE[™] open-end grip reduces rounding and stripping.
- Rounded I-Beam handle for comfortable handling grip.
- 15° offset box for better accessibility.
- Chrome alloy steel, chrome plated.

Description	Pack quantity	Min. order quantity	Article Number	EAN Code
MAX BITE [™] Combination Spanner Set Foam Insert	15	1	4932479827	4058546376215
8, 9, 10, 11, 12, 13, 14, 15, 16, 17, 18, 19, 20, 21, 22 mm				



MAX BITE™ Ratcheting Combination Spanner Set Foam Insert

- 144 Ratcheting teeth positions giving 2.5° arc swing allowing access in tighter spaces.
- Durable double stacked pawls for long-lasting ratchet life.
- MAX BITE™ open-end grip reduces rounding and stripping.
- Rounded I-Beam handle for comfortable handling grip.

Description	Pack quantity	Min. order quantity	Article Number	EAN Code
MAX BITE™ Ratcheting Combination Spanner Set Foam Insert	15	1	4932479828	4058546376222
8, 9, 10, 11, 12, 13, 14, 15, 16, 17, 18, 19, 20, 21, 22 mm				



Adjustable Wrench Set Foam Insert

NEW

- Precision adjustment screw with accurate threads and tight tolerances. The jaws won't back off during use
- Chrome plating for best-in-class rust protection and increased durability
- Ergonomic rounded handle design for a comfortable fit in the hand and less pressure points on the palm
- Slim head design for reaching into tight spaces

Description	Pack quantity	Min. order quantity	Article Number	EAN Code
3 pc Adjustable Wrench Set Foam Insert	3	1	4932492397	4058546417642
150mm, 200mm, 250mm				



Small Foam for 46" Steel Storage

NEW

- High density of foam improves durability and resistance to abrasion
- Quick and easy identification of tools and accessories due to the red background
- Laser cut foam to maximize the space in the 46" Steel Storage
- Ideal to store additional sockets, accessories, coins, screws and other small parts

Description	Pack quantity	Min. order quantity	Article Number	EAN Code
Small Foam for 46" Steel Storage	1	1	4932492389	4058546417567



Large Foam for 46" Steel Storage

NEW

- High density of foam improves durability and resistance to abrasion
- Quick and easy identification of tools and accessories due to the red background
- Laser cut foam to maximize the space in the 46" Steel Storage
- Ideal to store additional sockets, accessories, coins, screws and other small parts

Description	Pack quantity	Min. order quantity	Article Number	EAN Code
Large Foam for 46" Steel Storage	1	1	4932492390	4058546417574



PVC Work Surface

NEW

- PVC Work Surface for the 46" /117 cm High Capacity 10-Drawer Steel Storage Rolling Cabinet.
- Enables productive and safe work on top of the 46" Steel Storage Rolling Cabinet.
- Prevents items from rolling or falling from the surface.
- Easy installation with two adhesives strips (included in delivery).

Description	Pack quantity	Min. order quantity	Article Number	EAN Code
PVC Work Surface 46"	1	1	4932492547	4058546419141



PACKOUT™

The MILWAUKEE® PACKOUT™ modular storage system revolutionises tool transportation, organisation and storage. Designed to provide users with the ability to interchange and interlock a wide assortment of heavy duty tool boxes, organisers and storage totes in multiple different configurations.



**SCAN NOW TO
VIRTUALLY BUILD YOUR
PACKOUT SYSTEM**



SITE



TRANSIT





SHOP

OVER
100 POSSIBLE
COMBINATIONS

PACKOUT[™] 3 piece set

- 1 x PACKOUT[™] trolley box
- 1 x PACKOUT[™] large box
- 1 x PACKOUT[™] box



Contents	Pack quantity	Min. order quantity	Article Number	EAN Code
1 x PACKOUT [™] trolley box, 1 x PACKOUT [™] large box, 1 x PACKOUT [™] box	3	1	4932464244	4058546221898



PACKOUT[™] trolley box

- Part of the PACKOUT[™] modular storage system.
- Constructed with impact resistant polymers for jobsite durability.
- 113 kg weight capacity.
- Industrial grade extension handle.
- Oversized Ø 228 mm all terrain wheels.
- IP65 rated weather seal to keep out rain and jobsite debris.
- Metal reinforced corners.
- Metal reinforced locking point.
- Interior organiser tray.
- Mounting location for the ONE-KEY[™] TICK[™].

Description	Dimensions (mm)	Pack quantity	Min. order quantity	Article Number	EAN Code
PACKOUT [™] trolley box	560 x 410 x 480	1	1	4932464078	4058546220235



PACKOUT™ 2 wheeled cart

- 2 integrated PACKOUT™ mounting locations for additional storage options.
- Integrated holder for longer tools, such as levels.
- 180 kg weight capacity.
- 25 cm in-board wheels easily roll through doorways.
- Folding base plate for easy storage.
- Part of the PACKOUT™ modular storage system.
- Constructed with impact resistant polymers for jobsite durability.



Description	Dimensions (mm)	Pack quantity	Min. order quantity	Article Number	EAN Code
PACKOUT™ 2 wheeled cart	1200 x 510 x 290	1	1	4932472131	4058546325275



PACKOUT™ rolling tool chest

- Dual Stack Top allows to transport 2 PACKOUT™ stacks onto the jobsite.
- 23 cm all-terrain wheels for easy rolling through rough jobsite terrain.
- Industrial grade extension handle supports up to 113 kg.
- Protective lid seal helps prevent damage to the tools from water and jobsite debris.
- Extra storage capacity for large tools and jobsite materials.
- Constructed with impact resistant polymers for jobsite durability.
- Part of the PACKOUT™ modular storage system.



Description	Dimensions (mm)	Pack quantity	Min. order quantity	Article Number	EAN Code
PACKOUT™ rolling tool chest	965 x 609 x 401	1	1	4932478161	4058546340940



PACKOUT[™] flat trolley

- 113kg weight capacity.
- Durable casters to easily roll with heavy load on a jobsite.
- Includes 1 locking brake and 2 side locks to stop the trolley and easily connect the PACKOUT[™] boxes and bags.
- Part of the PACKOUT[™] modular storage system.



Description	Dimensions (mm)	Pack quantity	Min. order quantity	Article Number	EAN Code
PACKOUT [™] flat trolley	610 x 480 x 190	1	1	4932471068	4058546286965



PACKOUT[™] boxes

- Part of the PACKOUT[™] modular storage system.
- Constructed with impact resistant polymers for jobsite durability.
- IP65 rated weather seal to keep out rain and jobsite debris.
- Metal reinforced corners.
- Metal reinforced locking point.
- Interior organiser trays.
- Mounting location for the ONE-KEY[™] TICK[™].
- Metal reinforced top handle for easier carrying (only on the large box).



Description	Dimensions (mm)	Pack quantity	Min. order quantity	Article Number	EAN Code
① PACKOUT [™] large box	560 x 410 x 290	1	1	4932464079	4058546220242
② PACKOUT [™] box	560 x 410 x 170	1	1	4932464080	4058546220259



PACKOUT™ XL tool box

- Extra storage capacity for large power tools, such as band saws, angle grinders and hammers.
- 45 kg total weight capacity.
- Part of the PACKOUT™ modular storage system.
- Constructed with impact resistant polymers for jobsite durability.
- IP65 rated weather seal to keep out rain and jobsite debris.
- Metal reinforced corners.
- Interior organiser tray for smaller accessories.
- Mounting location for the ONE-KEY™ TICK™.



Description	Dimensions (mm)	Pack quantity	Min. order quantity	Article Number	EAN Code
PACKOUT™ XL tool box	554 x 394 x 422	1	1	4932478162	4058546340957



PACKOUT™ 3 drawer tool box

- PACKOUT™ Drawer Tool Box allows for easy access to your tools, even when placed at the bottom of the PACKOUT™ stack.
- Steel ball bearing slides support up to 11 kg of weight per drawer.
- Locking security bar prevents an unwanted opening of drawers during transit and allows to shut the drawers with a padlock.
- Each box comes with a set of Quick-Adjust Dividers that let users fully customise the layout of the drawers for better organisation.
- Metal reinforced corners.
- Constructed with impact resistant polymers for jobsite durability.
- Part of the PACKOUT™ modular storage system.



Description	Dimensions (mm)	Pack quantity	Min. order quantity	Article Number	EAN Code
PACKOUT™ 3 drawer tool box	560 x 410 x 360	1	1	4932472130	4058546325268



PACKOUT[™] 2 drawer tool box

- PACKOUT[™] Drawer Tool Box allows for easy access to your tools, even when placed at the bottom of the PACKOUT[™] stack.
- Steel ball bearing slides support up to 11 kg of weight per drawer.
- Locking security bar prevents an unwanted opening of drawers during transit and allows to shut the drawers with a padlock.
- Each box comes with a set of Quick-Adjust Dividers that let users fully customise the layout of the drawers for better organisation.
- Metal reinforced corners.
- Constructed with impact resistant polymers for jobsite durability.
- Part of the PACKOUT[™] modular storage system.



Description	Dimensions (mm)	Pack quantity	Min. order quantity	Article Number	EAN Code
-------------	-----------------	---------------	---------------------	----------------	----------

PACKOUT [™] 2 drawer tool box	560 x 410 x 360	1	1	4932472129	4058546325251
--	-----------------	---	---	------------	---------------



PACKOUT[™] cabinet

NEW

- Stacks on PACKOUT[™] boxes.
- Hangs on PACKOUT[™] Wall Mounting Plates.
- Secure stacking and hanging due to lock mechanism on bottom and rear.
- Front door to easy access stored tools and items inside. Door can be slid into the box to make access easy and comfortable.
- Weight capacity: 22 kg.
- Constructed with impact resistant material.
- Part of the PACKOUT[™] modular storage system.



Description	Dimensions (mm)	Pack quantity	Min. order quantity	Article Number	EAN Code
-------------	-----------------	---------------	---------------------	----------------	----------

PACKOUT [™] cabinet	508 x 381 x 381	1	1	4932480623	4058546409081
------------------------------	-----------------	---	---	------------	---------------



PACKOUT[™] organiser

- Part of the PACKOUT[™] modular storage system.
- Constructed with impact resistant polymers for jobsite durability.
- The interior features 10 removable & mountable bins that can be mounted onto common jobsite materials for easy access.
- IP65 rated weather seal to keep out rain and jobsite debris.
- No-travel bins seals to prevent the bins contents from migrating between bins during transport.



Description	Dimensions (mm)	Pack quantity	Min. order quantity	Article Number	EAN Code
-------------	-----------------	---------------	---------------------	----------------	----------

PACKOUT [™] organiser	500 x 380 x 120	1	1	4932464082	4058546220273
--------------------------------	-----------------	---	---	------------	---------------

PACKOUT™ compact organiser

- Part of the PACKOUT™ modular storage system.
- Constructed with impact resistant polymers for jobsite durability.
- The interior features 5 removable & mountable bins that can be mounted onto common jobsite materials for easy access.
- IP65 rated weather seal to keep out rain and jobsite debris.
- No-travel bins seals to prevent the bins contents from migrating between bins during transport.



Description	Dimensions (mm)	Pack quantity	Min. order quantity	Article Number	EAN Code
PACKOUT™ compact organiser	250 x 380 x 120	1	1	4932464083	4058546220280



PACKOUT™ slim organiser

- Part of the PACKOUT™ modular storage system.
- Constructed with impact resistant polymers for jobsite durability.
- Interior features 2 large bins and 8 small bins. All bins contain dividers.
- No travel bin seals to prevent the bins contents from migrating between bins during transportation.
- IP 65 rated weather seal to keep out rain and jobsite debris.



Description	Dimensions (mm)	Pack quantity	Min. order quantity	Article Number	EAN Code
PACKOUT™ slim organiser	500 x 414 x 65	1	1	4932471064	4058546286927



PACKOUT™ compact slim organiser

- Part of the PACKOUT™ modular storage system.
- Constructed with impact resistant polymers for jobsite durability.
- Interior features 1 large bin and 4 small bins. All bins contain dividers.
- No travel bin seals to prevent the bins contents from migrating between bins during transportation.
- IP 65 rated weather seal to keep out rain and jobsite debris.



Description	Dimensions (mm)	Min. order quantity	Pack quantity	Article Number	EAN Code
PACKOUT™ compact slim organiser	250 x 380 x 65	1	1	4932471065	4058546286934

PACKOUT[™] deep organiser

- 50% higher than the standard PACKOUT[™] organiser - ideal to store tools, batteries, chargers, larger fittings and other equipment.
- Quick Adjust Dividers allow users to customise storage to their needs.
- 22 kg total weight capacity.
- Part of the PACKOUT[™] modular storage system.
- Constructed with impact resistant polymers for jobsite durability.
- IP 65 rated weather seal to keep out rain and jobsite debris.



Description	Dimensions (mm)	Pack quantity	Min. order quantity	Article Number	EAN Code
PACKOUT [™] deep organiser	507 x 386 x 170	1	1	4932478625	4058546348182



PACKOUT[™] crate

- Versatile stacking options: vertical and horizontal.
- 22 kg weight capacity.
- Large storage capacity for all kind of tools.
- Other PACKOUT[™] products can be stacked on top of the crate.
- Part of the PACKOUT[™] modular storage system.



Description	Dimensions (mm)	Pack quantity	Min. order quantity	Article Number	EAN Code
PACKOUT [™] crate	475 x 390 x 250	1	1	4932471724	4058546296230



PACKOUT™ compact tool box

- Quick-Adjust Dividers allow users to store and organize larger equipment and accessories, such as fittings, connectors or caulk.
- Enough storage capacity to fit power tools like circular saws, grinders, drill drivers.
- 34 kg weight capacity.
- Constructed with impact resistant polymers for jobsite durability.
- IP 65 rated weather seal to keep out rain and jobsite debris.
- Part of the PACKOUT™ modular storage system.



Description	Dimensions (mm)	Pack quantity	Min. order quantity	Article Number	EAN Code
PACKOUT™ compact tool box	411 x 254 x 330	1	1	4932471723	4058546292232



PACKOUT™ hard cooler

- Double premium insulation keeps contents cold for up to 30 hours.
- IP 65 Food Grade Leak-Proof Liner prevents leakages and protects contents from debris and dust.
- Integrated bottle opener.
- Removable tray for separate storage of personal items to keep them elevated above icy water.
- 15 l capacity.
- Constructed with impact resistant polymers for jobsite durability.
- Part of the PACKOUT™ modular storage system



Description	Dimensions (mm)	Pack quantity	Min. order quantity	Article Number	EAN Code
PACKOUT™ hard cooler	411 x 254 x 330	1	1	4932471722	4058546296216



PACKOUT[™] racking system

- E-Track mounting rails can be mounted on the wall in vehicles, shops or garages for ultimate versatility.
- Quick release design for easy mounting, height adjustment and removal of the shelves.
- Each shelf supports up to 22 kg of weight.
- Metal reinforced frame.
- Impact resistant polymer construction.
- Part of the PACKOUT[™] modular storage system.



Description	Dimensions (mm)	Pack quantity	Min. order quantity	Article Number	EAN Code
① PACKOUT [™] racking system kit (2 shelves + E-track)	546 x 447 x 508	4	1	4932472127	4058546325237
② PACKOUT [™] racking system - single shelf	533 x 422 x 99	1	1	4932478711	4058546349042
③ Vertical E-track for PACKOUT [™] racking system 50 cm	90 x 508 x 25	2	1	4932478996	4058546362782



PACKOUT[™] mounting plate

- Multiple mounting configurations.
- Turn PACKOUT[™] into stationary shop storage.
- Connects to all MILWAUKEE[®] PACKOUT[™] modular storage.
- Constructed with impact resistant polymers for highest durability.
- Metal reinforced mounting points for carrying high weights.
- Organise your shop together with PACKOUT[™] boxes and wall accessories.

Description	Dimensions (mm)	Pack quantity	Min. order quantity	Article Number	EAN Code
① PACKOUT [™] mounting plate	600 x 470 x 030	1	4	4932471638	4058546295370
② PACKOUT [™] compact mounting plate	254 x 508 x 25	1	6	4932480621	4058546409067
③ PACKOUT [™] XL mounting plate	762 x 508 x 25	1	6	4932480622	4058546409074



PACKOUT™ customisable work surface

- Marine grade plywood top provides smooth surface for light assembly work, writing, sketching or working on a laptop.
- Fastener-ready surface allows for easy mounting of common jobsite materials and larger tools on top of a PACKOUT™ stack.
- 22 kg weight capacity.
- Part of the PACKOUT™ modular storage system.
- Constructed with impact resistant polymers for jobsite durability.



Description	Dimensions (mm)	Pack quantity	Min. order quantity	Article Number	EAN Code
PACKOUT™ customisable work surface	60 x 650 x 380	1	6	4932472128	4058546325244



PACKOUT™ tool tray

NEW

- Flexible additional organisation.
- Modular connectivity with PACKOUT™ components: stack on and store in other PACKOUT™ Tool Boxes.
- Fits inside of: PACKOUT™ Large Box, PACKOUT™ Trolley Box, PACKOUT™ XL Tool Box, PACKOUT™ Rolling Tool Chest.
- Top carry handle allows easy transport.
- Includes Quick-Adjust-Dividers for custom storage layouts.
- 11 kg weight capacity.
- Part of the PACKOUT™ modular storage system.



Description	Dimensions (mm)	Pack quantity	Min. order quantity	Article Number	EAN Code
PACKOUT™ tool tray	503 x 297 x 127	1	1	4932480625	4058546409104

PACKOUT™ crate divider

NEW

- Separates the PACKOUT™ Crate into multiple storage zones.
- The back wing allows half width PACKOUT™ products to sit on top of the Crate.
- Mounting holes for the attachment of chargers and other items.
- Part of the PACKOUT™ modular storage system.



Description	Dimensions (mm)	Pack quantity	Min. order quantity	Article Number	EAN Code
PACKOUT™ crate divider	330 x 234 x 94	1	1	4932480624	4058546409098

PACKOUT[™] adaptor HD box

- Heavy duty boxes adaptor for PACKOUT[™] system.
- Fits on top of PACKOUT[™] boxes.
- Enables to carry heavy duty boxes on top of PACKOUT[™] boxes for the most versatile storage solution.
- Made of impact resistant material.



Description	Dimensions (mm)	Pack quantity	Min. order quantity	Article Number	EAN Code
PACKOUT [™] adaptor HD box	500 x 386 x 117	1	1	4932464081	4058546220266

PACKOUT[™] foam inserts

- Fully customisable - foam insert allows you to fully customise your storage by cutting out custom pockets to securely store and protect your tools.
- Durable construction provides increased protection for tools.
- Optimised storage - allows easy access to the tools.
- Ref. 4932471428: Designed to fit in two PACKOUT[™] boxes - tool box (4932464080) & large tool box (4932464079).
- Ref. 4932471927: Designed to fit in the PACKOUT[™] trolley box (4932464078).



Description	Pack quantity	Min. order quantity	Article Number	EAN Code
PACKOUT [™] foam insert	2	1	4932471428	4058546290566
PACKOUT [™] trolley foam insert	1	1	4932471927	4058546298265
Foam insert for PACKOUT [™] drawer tool boxes	2	1	4932479157	4058546369514



PACKOUT™ inserts

- Removable inserts for PACKOUT™ boxes and organisers.
- Ref. 4932478298: Organisation tray designed to fit PACKOUT™ trolley box (4932464078) and large box (4932464079).
- Ref. 4932478299: Set of organisation trays designed to fit PACKOUT™ box (4932464080).
- Ref. 4932478300: Set of organisation boxes designed to fit PACKOUT™ organiser (4932464082) and compact organiser (4932464083).
- Ref. 4932478301: Set of organisation boxes designed to fit PACKOUT™ slim organiser (4932471064) and compact slim organiser (4932471065).

Description	Pack quantity	Min. order quantity	Article Number	EAN Code
① Removable tray for PACKOUT™ trolley box and large box	1	1	4932478298	4058546344757
② Removable trays for PACKOUT™ box	4	1	4932478299	4058546344764
③ Removable bins for PACKOUT™ slim organiser and compact slim organiser	5	1	4932478301	4058546344788
④ Removable bins for PACKOUT™ organiser and compact organiser	5	1	4932478300	4058546344771
⑤ Drawer dividers for PACKOUT™ 3 drawer tool box	8	1	4932479104	4058546368982
⑥ Drawer dividers for PACKOUT™ 2 drawer tool box	8	1	4932479105	4058546368999

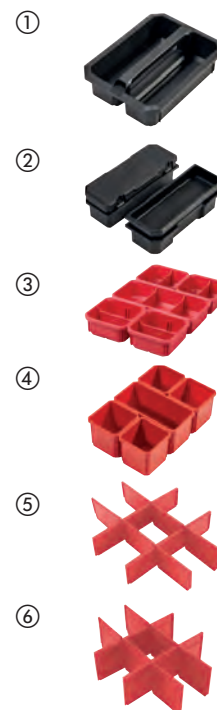

MAX BITE™ spanner and plier set PACKOUT™ foam insert

- MAX BITE™ open-end grip reduces rounding and stripping
- Rounded I-Beam handle for comfortable handling grip
- Ink-filled labels for clear visibility
- Waterpump plier with V-groove jaws with profile for firmer grip, more precise fit and reduced slipping. Special teeth hardening 60 HRC
- All pliers have a special teeth hardening - 60 HRC - for best teeth durability and toughness
- Fits perfectly into the PACKOUT™ Drawer Tool Box
- Laser cut high quality foam for perfect tool storage

Description	Pack quantity	Min. order quantity	Article Number	EAN Code
MAX BITE™ spanner and plier set PACKOUT™ foam insert 19 pc				
8mm, 9mm, 10mm, 11mm, 12mm, 13mm, 14mm, 15mm, 16mm, 17mm, 18mm, 19mm, 20mm, 21mm and 22 mm combination spanner; 210mm long nose plier, 160mm diagonal cutter, 150mm water pump plier, 150mm adjustable wrench	19	1	4932480715	4058546410001



Ratchet and socket **PACKOUT**[™] Drawer foam insert

- 90 tooth design ratchet with 4° of arc swing for tight work spaces
- **FOUR FLAT**[™] sides on socket for an anti-roll and wrench-ready solution
- Fits perfectly into the **PACKOUT**[™] Drawer Tool Box
- Laser cut high quality foam for perfect tool storage



Description	Pack quantity	Min. order quantity	Article Number	EAN Code
<p>① 1/2" Ratchet, socket and hex key set PACKOUT[™] foam insert 70 pc</p> <p>1/2" drive ratchet; 10mm, 11mm, 12mm, 13mm, 14mm, 15mm, 16mm, 17mm, 18mm, 19mm, 20mm, 21mm, 22mm, 23mm, 24mm 1/2" drive standard sockets and 10mm, 11mm, 12mm, 13mm, 14mm, 15mm, 16mm, 17mm, 18mm, 19mm deep well sockets; 76mm and 127mm 1/2" drive extensions; 9 pc Hex key set; Shockwave[™] Impact Rated Screwdriving Bits 2 x TX10 / 4 x TX15 / 5 x TX20 / 5 x TX25 / 5 x TX30 / 2 x TX40 / 1 x TX50, 1 x TX B07 / 1 x TX B08 / 1 x TX B09 / 1 x TX B010 / 1 x TX B015 / 1 x TX B020 / 1 x TX B025. 1 x Shockwave[™] Impact Rated Bit Holders</p>	70	1	4932480716	4058546410018
<p>② 1/4" drive ratchet, socket, screwdriver and wrench set PACKOUT[™] foam insert</p> <p>1/4" drive ratchet; 5mm, 5.5mm, 6mm, 7mm, 8mm, 9mm, 10mm, 11mm, 12mm, 13mm, 14mm, 15mm 1/4" drive standard and deep well sockets; 76mm and 152mm extensions, 1/4" driver universal joint; 6 Tri-Lobe screwdrivers (SL3 / SL4 / SL5 / SL6 / PH1 / PH2); 250mm adjustable wrench</p>	35	1	4932480717	4058546410025

PACKOUT[™] tote toolbag

- Part of the **PACKOUT**[™] modular storage system.
- 1680 ballistic material construction.
- Impact resistant molded base.
- All metal hardware.
- Durable overmolded handle.



Description	Dimensions (mm)	No. of pockets	Pack quantity	Min. order quantity	Article Number	EAN Code
① 25 cm tote toolbag	300 x 250 x 320	28	1	1	4932464084	4058546220297
② 40 cm tote toolbag	250 x 400 x 430	31	1	1	4932464085	4058546220303
③ 50 cm tote toolbag	280 x 500 x 430	32	1	1	4932464086	4058546220310



PACKOUT™ duffel bag

- Part of the PACKOUT™ modular storage system.
- Made from 1680D Ballistic Material for jobsite durability.
- Impact resistant polymer base protects contents from water, dirt and tear.
- Large storage capacity for larger tools.
- Cushioned shoulder strap, top and side handles for flexible carry.



Description	Dimensions (mm)	Pack quantity	Min. order quantity	Article Number	EAN Code
① 38 cm PACKOUT™ duffel bag	380 x 250 x 340	1	1	4932471066	4058546286941
② 50 cm PACKOUT™ duffel bag	500 x 310 x 350	1	1	4932471067	4058546286958



PACKOUT™ tech bag

- Part of the PACKOUT™ modular storage system.
- Made from 1680D ballistic material for jobsite durability.
- 58 total pockets. Hardshell protected instrument pocket.
- Secure and protected storage for laptops and tablets.
- Impact resistant polymer base protects contents from water, dirt and tear.



Description	Dimensions (mm)	Pack quantity	Min. order quantity	Article Number	EAN Code
PACKOUT™ tech bag	430 x 270 x 450	1	1	4932471130	4058546287580

PACKOUT™ backpack

- Part of the PACKOUT™ modular storage system.
- Made from 1680D ballistic material for jobsite durability.
- 48 total pockets including a hard-shell protected instrument pocket.
- Extra back padding, chest strap, attachment strap for rolling bags and heavy duty harness for ultimate jobsite comfort.
- Impact resistant polymer base protects contents from water and dirt and also allows backpack to stand up.



Description	Dimensions (mm)	Pack quantity	Min. order quantity	Article Number	EAN Code
PACKOUT™ backpack	380 x 240 x 500	1	1	4932471131	4058546287597

PACKOUT[™] jobsite cooler

- Part of the PACKOUT[™] modular storage system.
- 20l volume capacity with a dry compartment and a storage space for drinks.
- Extra insulation keeps contents cold for 24 hours.
- Impact resistant polymer base protects contents from water, dirt, and tear.
- Shoulder strap for easy transport.



Description	Dimensions (mm)	Pack quantity	Min. order quantity	Article Number	EAN Code
PACKOUT [™] jobsite cooler	380 x 240 x 330	1	1	4932471132	4058546287603

PACKOUT[™] tumbler

NEW

- Double wall vacuum insulation for all day hot & cold retention.
- Rotating magnetic closure for easy opening.
- 18/8 stainless steel for durability.
- Dishwasher safe.
- Twist and lock mechanism for connectivity with all PACKOUT[™] components.



Description	Pack quantity	Min. order quantity	Article Number	EAN Code
PACKOUT [™] tumbler 591 ml	1	6	4932479074	4058546368685
PACKOUT [™] tumbler 887 ml	1	6	4932479075	4058546368692



PACKOUT™ SHOP STORAGE



A NEW LEVEL OF JOBSITE ORGANISATION.

To relieve the frustration of messy and unorganised workshops, we're bringing the versatility of the PACKOUT system into a new worksite shop solution. The solution includes 20 new accessories that enable you to fully customise your own personal one-stop shop for organising your tools and equipment.



**SCAN NOW TO
VIRTUALLY BUILD
YOUR OWN SHOP
STORAGE SYSTEM**

PACKOUT[™] storage hooks

NEW

- High strength steel hooks for storing even heavy tools and items.
- Hook coating protects hooks and stored items.
- Easy and fast access to all tools.
- Most secure and easy mounting with click & lock mechanism.
- Fully customise your shop according to your needs.
- Part of PACKOUT[™]Shop Storage.



Description	Dimensions (mm)	Pack quantity	Min. order quantity	Article Number	EAN Code
① PACKOUT [™] straight utility hook	89 x 203 x 229 x 63	1	5	4932480700	4058546409852
② PACKOUT [™] curved utility hook	89 x 279 x 152 x 63	1	5	4932480701	4058546409869
③ PACKOUT [™] large hook	89 x 203 x 229 x 152	1	3	4932480702	4058546409876
④ PACKOUT [™] large S hook	89 x 178 x 38	1	5	4932480703	4058546409883
⑤ PACKOUT [™] small straight utility hook.	89 x 102 x 102 x 63	1	5	4932480704	4058546409890
⑥ PACKOUT [™] small curved utility hook	89 x 178 x 76 x 63	1	5	4932480705	4058546409906

PACKOUT[™] storage racks

NEW

- Easy and fast access to all tools and items.
- Most secure and easy mounting with click & lock mechanism.
- Fully customise your shop according to your needs.
- Part of PACKOUT[™]Shop Storage.

Description	Dimensions (mm)	Pack quantity	Min. order quantity	Article Number	EAN Code
① PACKOUT [™] cup holder	102 x 178 x 127	1	4	4932480706	4058546409913
② PACKOUT [™] paper towel holder	102 x 330 x 165	1	5	4932480707	4058546409920
③ PACKOUT [™] pliers rack	241 x 127 x 89	1	6	4932480710	4058546409951
④ PACKOUT [™] screwdriver rack	236 x 90 x 90	1	6	4932480711	4058546409968
⑤ PACKOUT [™] small shelf	241 x 89 x 254	1	5	4932480713	4058546409982



PACKOUT[™] battery holders

NEW

- Organise your batteries.
- Clip in batteries for secure storage.
- Easy and fast access to all batteries.
- Most secure and easy mounting with click & lock mechanism.
- Fully customise your shop according to your needs.
- Part of PACKOUT[™]Shop Storage.

Description	Dimensions (mm)	Pack quantity	Min. order quantity	Article Number	EAN Code
① PACKOUT [™] M12 [™] battery holder	102 x 330 x 66	1	6	4932480708	4058546409937
② PACKOUT [™] M18 [™] battery holder	102 x 330 x 102	1	4	4932480709	4058546409944



PACKOUT™ easy access storage

NEW

- Easy and fast access to all tools.
- Most secure and easy mounting with click & lock mechanism.
- Fully customise your shop according to your needs.
- Part of PACKOUT™Shop Storage.

Description	Dimensions (mm)	Pack quantity	Min. order quantity	Article Number	EAN Code
① PACKOUT™ drill storage station	241 x 356 x 254	1	2	4932480712	4058546409975
② PACKOUT™ long handled storage	241 x 356 x 178	1	3	4932480714	4058546409999



PACKOUT™ nest bin

NEW

- Stores screws, tapes and other small items.
- Comes with removable dividers and interior trays for additional organisation.
- Hangs on PACKOUT™Wall Mounting Plates.
- Fits in PACKOUT™Organizer (4932464082) & PACKOUT™Compact Organizer (4932464083).
- Constructed with impact resistant polymers.
- Part of PACKOUT™Shop Storage.

Description	Dimensions (mm)	Pack quantity	Min. order quantity	Article Number	EAN Code
① PACKOUT™ 10x10 cm nest bin	102 x 102 x 102	2	6	4932480698	4058546409838
② PACKOUT™ 10x20 cm nest bin	203 x 102 x 102	2	6	4932480699	4058546409845



Ultimate jobsite backpack

- Constructed with 1680D ballistic material and with rugged metal zippers to provide increased durability.
- Hard molded base allows backpack to stand up and reduces ingress of dirt and water.
- Adjustable chest strap and attachment strap for rolling bags.
- Padded and breathable load-bearing harness evenly distributes the weight for more comfort and jobsite performance.
- 48 total pockets including 2 hardshell pockets to protect electronics and equipment from impact.
- Backpack provides exceptional organisation.



Description	Dimensions (mm)	Pack quantity	Min. order quantity	Article Number	EAN Code
Ultimate jobsite backpack	240 x 457 x 518	1	1	4932464833	4058546227784



Jobsite backpack

- Durable construction, made from 1680D ballistic nylon.
- Hard moulded base allows bag to stand-up and provides ultimate all-weather protection.
- Padded, breathable straps for ultimate comfort and jobsite performance.
- Large storage - 35 pockets in total.
- Fold down front pocket for easier access and storage of larger items. Side water bottle pocket.
- Vertical tool wall maximises storage space while allowing for bulk storage space.
- Laptop pocket allows protected storage for laptops/tablets and personal goods.
- Exterior daisy chains allow clip on storage.



Description	Dimensions (mm)	Pack quantity	Min. order quantity	Article Number	EAN Code
Jobsite backpack	363 x 203 x 594	1	1	48228200	045242333943



Tradesman backpack

- Durable construction, made from 1680D ballistic nylon.
- Padded straps for more comfort and jobsite performance.
- Laptop pocket allows protected storage for laptops/tablets and personal goods.
- 18 organiser pockets allow variety of options.



Description	Dimensions (mm)	Pack quantity	Min. order quantity	Article Number	EAN Code
Tradesman backpack	360 x 210 x 520	1	1	4932464252	4058546221973

Low profile backpack

- Constructed with 1680D ballistic material and with rugged metal zippers to provide increased durability.
- Reinforced base protects the backpack from being damaged by abusive jobsite conditions.
- Adjustable chest strap and attachment strap for rolling bags.
- Padded and breathable load-bearing harness evenly distributes the weight for more comfort and jobsite performance.
- 22 pockets including a padded electronic sleeve to provide ultimate organisation.



Description	Dimensions (mm)	Pack quantity	Min. order quantity	Article Number	EAN Code
Low profile backpack	200 x 300 x 498	1	1	4932464834	4058546227791

Jobsite cooler

- Constructed with 1680D ballistic material and with rugged metal zippers to provide increased durability.
- Specifically designed to be durable enough to withstand tough jobsite conditions.
- Cooler utilises double insulation and a food-grade leak proof liner to keep ice cold for 24 hours without leaking.
- Tape measure clip with a bottle opener provides ultimate versatility.
- Padded shoulder strap with metal hardware for ultimate durability.
- Tech pocket and dry storage compartment for storing tablets and electronic devices.



Description	Dimensions (mm)	Pack quantity	Min. order quantity	Article Number	EAN Code
Jobsite cooler	280 x 350 x 380	1	1	4932464835	4058546227807

Electricians pouch

- Robust construction, made from 1680D ballistic nylon.
- Double stitched with stronger riveted seams.
- Integrated handle allows easy transport and provides an easy mounting point on common jobsite materials.
- Solid base allows bag to stand-up, even when fully loaded.
- Integrated belt loops allow bag to be worn on a tool belt.
- Center mounted metal D-rings allow bag to hang evenly from shoulder strap.
- Metal tape measure clip securely stores tape for easy access.



Description	Pack quantity	Min. order quantity	Article Number	EAN Code
Electricians pouch	1	1	48228112	045242509157

Contractor rig

- Robust construction, made from 1680D ballistic nylon.
- Double stitched with stronger riveted seams.
- Padded 4-point harness distributes weight for all day comfort.
- Padded, breathable belt for ultimate comfort and jobsite performance.
- Integrated handle allows easy transport of the pouch and provides easy mounting point on common jobsite materials.
- Metal suspender attachments allow suspenders to be added.



Description	Pack quantity	Min. order quantity	Article Number	EAN Code
Contractor rig	1	1	48228120	045242333974

Padded rig

- Adjustable straps designed to fit all users.
- 1680D ballistic material construction.



Description	Pack quantity	Min. order quantity	Article Number	EAN Code
Padded rig	1	1	48228145	045242358212

Work belt

- Metal hardware and 1680D ballistic nylon provide a lifetime of service.
- Up to 152 mm (6") of padding and can accommodate waist sizes up to 143 mm (5 3/4").



Description	Pack quantity	Min. order quantity	Article Number	EAN Code
Work belt	1	1	48228140	045242358168

HEAVY DUTY™ boxes

- Cases supplied with latches and foam.

HD box size	Dimensions (mm)	Pack quantity	Min. order quantity	Article Number	EAN Code
1	475 x 358 x 132	1	1	4932453385	4002395146376
3	475 x 358 x 230	1	1	4932453386	4002395143634
HD Box 1 universal - supplied with foam insert		1	1	4932459751	4058546029234
HD Box 1 universal - with FUEL logo - supplied with foam insert		1	1	4932459206	4002395287215
Spare latches		2	1	4932373252	4002395347247
PACKOUT™ adaptor HD box		1	1	4932464081	4058546220266





Nothing but **HEAVY DUTY.**TM

Techtronic Industries GmbH

Max-Eyth-Str. 10
D-71364 Winnenden
Germany
Tel. +49 7195 120
Fax +49 7195 666

Distributed by: