

SPACE[®]



Mini catalogue



SPACE 3D WHEEL ALIGNMENT

SPHERE ALIGNMENT



USUAL 3D

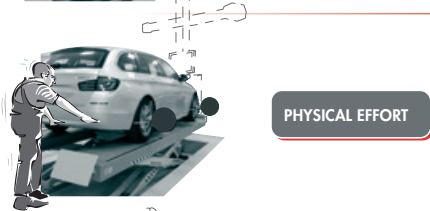
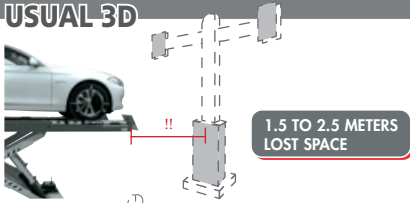

SPHERE ALIGNMENT

NO OBSTACLE



NO INTERRUPTION



NO COMPENSATION
(HPR, HP.B, SP)



NO LIMITATION





ARP 3DHP.B
ARP 3DHPR



ARP 3DSP



ARP 3DL

AUX		TY QUATRO		1200 - 2000	
Convergence int.	0.0	0.0	0.0	0.0	0.0
Div. vertex axis	0.0	0.0	0.0	0.0	0.0
Convergence axis	0.0	0.0	0.0	0.0	0.0
Angle vertex	0.0	0.0	0.0	0.0	0.0
Convergence int.	0.0	0.0	0.0	0.0	0.0
Convergence axis	0.0	0.0	0.0	0.0	0.0
Angle vertex	0.0	0.0	0.0	0.0	0.0

QUICK DATA



LIFT LEVEL COMPENSATION

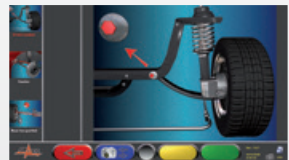

3D INFO

- > Assetti ruote
- > Wheel aligners
- > Achsmessgeräte
- > Contrôle de la géométrie
- > Alineadores de dirección



Bluetooth[®]

ACTIVE WS

ARC 78WS 8CCD

ARC 76WS 6CCD



Bluetooth[®]

ACTIVE PLUS WS

ARN 84WS 8CCD



Bluetooth[®]

MATRIX WS

ARS 680WS 8CCD

ARS 660WS 6CCD



Bluetooth®

DYNAMIC TRUCK

ART 98TWSR 8CCD - Drop-down Sensors

ART 98TWS 8CCD



Bluetooth®

ACTIVE TRUCK

ART 86TWSR 6CCD - Drop-down Sensors

ART 86TWS 6CCD

REMOTE CONTROL on SmartPhone



**NEW 18 METERS
4 LED SENSORS**

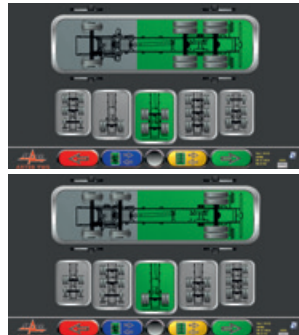

- > Assetto ruote su tablet
- > *Tablet controlled wheel aligner*
- > Tablet gesteuertes Achsmessgerät
- > *Geometrie sur tablette*
- > Alineador su tablet

ALIGNER CCD2.0WIFI

SPTD2.0WIFI



Tablet incluso.
Tablet included.



Optional Clamp Holder



STDA156



STDA156



STDA155

STDA157



TEq-Link



WHEEL ALIGNERS



ROLLER BRAKE TESTER & TIRE PROFILER



SHOOT&GO



STDASHOOT

Facile accesso ai dati del veicolo con una semplice foto del numero di targa!
Già disponibile in Italia, verificare per altri Paesi.
Easy access to the vehicle data with a simple photo of the plate number!
Currently available in many countries (please check availability).

ADAS

CCD aligner

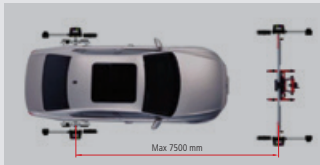

3D aligner

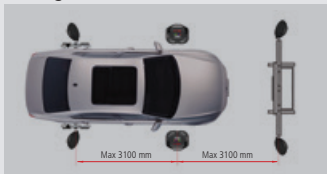

STDA150xx

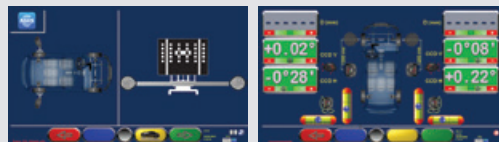



- > Misuratore della profondità del battistrada
- > Tyre tread depth measuring system
- > Reifenprofil-Messgerät
- > Mesureur de la sculpture du pneu
- > Medidor de la banda de rodadura

WS SERIES

PROFILER

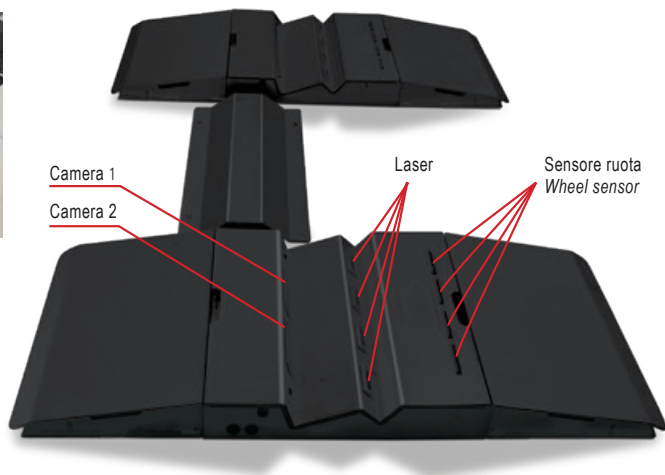
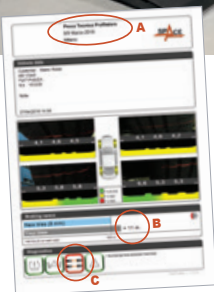

SP WS 101

Carrello con PC per uso in officina, con accesso diretto ai dati del cliente e ai valori di misura. Il software opera su Windows.

Workshop PC on trolley with direct access to customer data and measurement values. The software runs on any Windows based system.



SP WS 102

Kit per il collegamento al Gestionale dell'officina. Include un pannello elettrico contenente il PC.

Kit to be connected to the workshop's system. Includes one electrical box complete with PC to be connected to the existing workshop PC.

OPTIONS

SWS102A2 (→ SP WS101 - WS102)

Kit semaforo e telecamera per riconoscimento targhe.

Traffic light and camera for automatic plate recognition.





QUICK INSPECTION

I rilevatori e i target anteriori vengono messi in posizione
 - in pochi secondi vengono misurate la convergenza totale e le campanature anteriori.

*Front targets and measuring heads are positioned
 - in just few seconds total toe and front camber are displayed.*

I supporti vengono posizionati in zona accettazione.

Quick control stands are placed in the reception area.



- > Linee diagnosi
- > Test lanes
- > Prüfstrassen
- > Chaines de contrôle
- > Lineas de diagnóstico



PRO-LANE

PFC 750 / PFC 800

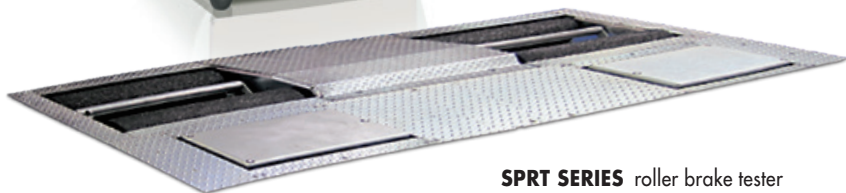

SPRT SERIES roller brake tester

DIGITAL



Inizio prova / Test start
SPRT003D



Risultati prova
(forze frenanti e sbilanciamento)
*Test results
(brake forces and imbalance)*



Efficienza frenante (versioni P)
Brake efficiency (P version)

VARRT102/4WDMAN

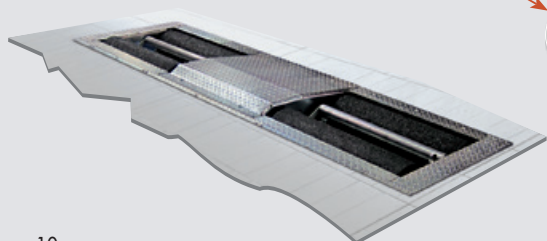

SPRT004
Ripetitore su monitor
Video repeater



PRO-LANE
TRUCK

TEST LANE
CONNECT

PFB (100, 150, 200 series) single speed
PFB (1003, 1503, 715 series) double speed



SRT 064BHTX
Forza - Force

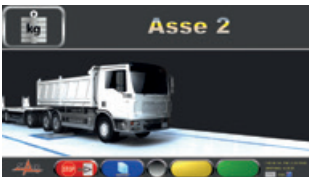
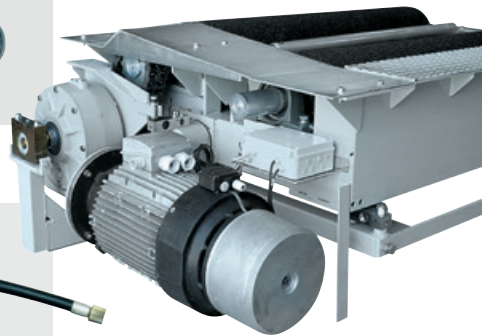

SRT 051BHTX (P1)
SRT 052BHTX (P2)
Pressione - Pressure

- > **Equilibratrici con comandi logici interattivi**
- > **Wheel balancers with interactive keyboard**
- > **Radauswuchtmaschinen mit logisch gekoppelten Funktionstasten**
- > **Equilibreuses avec commandes logiques interactives**
- > **Equilibradoras con mandos lógicos interactivos**

- * laser for weight positioning
- * touchless ultrasound wheel width gauge
- * rim illumination



ER 255
ERP 255

Monitor TFT SVGA 19"
19" TFT SVGA monitor



ER 248
ERP 248 - Airlock
Schermo LCD integrato
Integrated LCD display



GAR 325 - 80 kg
Sollevatore ruota standard
Wheel lift, standard version

GAR 324 - 80 kg - NO GRAVITY
Sollevatore ruota con bilanciamento automatico del peso
Wheel lift with automatic compensation of wheel weight



ER 238 (2D)
ER 234
Schermo LCD integrato
Integrated LCD display



ER 250R

BIKE EQUIPMENT



PFB 030 3000



ER 228 BIKE



GA 2240.BIKE

- > Smontagomme
- > Tyre changers
- > Reifenmontiergeräte
- > Démonte-pneus
- > Desmontadoras

COMPLETAMENTE SENZA LEVA
COMPLETELY LEVERLESS

GA2945.26 MEMO

GA 2945ITD.26S
Smontagomme senza leva
Leverless tyre changer



GIOTTO

GA 560.30 IT
Smontagomme senza leva
Leverless tyre changer

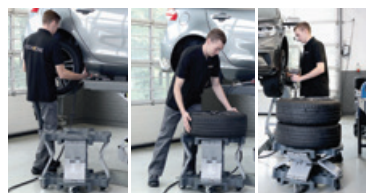

GR 20
Wheel trolley easy lift

GR 80WS
Sollevatore Ruote
Wheel lift

J-AUTOLEVER

COMPLETAMENTE SENZA LEVA
COMPLETELY LEVERLESS



GA 2845
GA 2841



PLUS83
Helper

GA 2645
GA 2641

Il top degli smontagomme a piatto
The top of table tyre changers



GA 2441
GA 1441



GA 2240

- > Smontagomme per ruote di veicoli industriali
- > Tyre changers for industrial wheels
- > Reifenmontiermaschinen für LKW
- > Démonte-pneus pour roues d'engins industriels
- > Desmontadoras para ruedas de vehículos industriales



GG 60360.15 (11"-42"/60")
GG 40256.15 (11"-42"/56")
 Doppio movimento carri
 Double carriage movement



GG 50156.15 (12"-42" / 56")
GG 30156.13/11 (11"-43"/56")
 Una gamma completa
 A complete range



GG 526N (12"-27")
 Ideale per autocarro e autobus
 Ideal for truck and bus

- > Servizio Mobile
- > Mobile Service
- > Mobile Einsatz
- > Service Mobile
- > Servicio Movil



COMPACT + LIGHT

MOBILE SERVICE

GGRS 926.MOVI
 Smontagomme idraulico retrattile
 Hydraulic tilting tyre changer



ERL 280RC



ERL 240RC

- > Sollevatori autocarro
- > Truck lifts
- > LKW - Bühnen
- > Élévateurs PL
- > Elevadores camion

	kg	mm (A)
SF 8825.8	25.000	8.000
SF 8825.9	25.000	9.000
SF 8825.10	25.000	10.000
SF 8835.9	35.000	9.000
SF 8835.10	35.000	10.000
SF 8835.13	35.000	13.000



Scissor Lifts

SF 7709 9 t

SF 7713N 13 t



TRANSMISSION JACKS

- > Sollevatori da fossa
- > Pit and transmission jacks
- > Getriebeher
- > Vérins de fosse
- > Gatos de foso

SUSPENDED

J 155.8 F - 15,5T
(800/1000 mm)



KE 200M - 20T (1.200 mm)



KE 150X - 15/15T (1.200 mm)



Mechanical Series

SM 2200 4 t

SM 2300 5.5 t

SM 2400 7 t

SM 2600 8.5 t

Per colonna
Per column

Wireless Series

SM 305H.WS 5.5 t

SM 307H.WS 7.5 t

SM 308H.WS 8.5 t

Hydraulic Series

SM 297H 7.5 t

Per colonna
Per column



4-Post Mechanical Lifts

SQ 40NE.9 - 24 t

SQ 42NE - 14 t

SQ 42E - 12 t

4-Post Mechanical Lift for Fork Lift

SQ 75E - 10 t

- > Sollevatori a 2 colonne
- > 2 posts lifts
- > 2-Säulen-Hebebühnen
- > *Élévateurs 2 colonnes*
- > Elevadores de 2 columnas



Sollevatori elettromeccanici
Electromechanical

SDB

Trasmissione a barra
Shaft transmission

SDC

Trasmissione a catena
Chain transmission

SDB/SDC - 3200 kg

SDB - 3500 kg

SDB - 4000 kg



SDE

Senza base
Baseless

SDE 2337 - 3200 kg

SDE 2349 - 4200 kg

SDE 2255 - 5500 kg



SDE 5. 337 - 3200 kg

SDE 5. 349 - 4000 kg



Elettroidraulici
Electro-hydraulic

SDH 370.32 - 3200 kg

SDH 370.45 - 4500 kg

SDH 370.50 - 5000 kg

SDH 370.55 - 5500 kg

SDH 370.70 - 7000 kg

SB 1450 - 3200 kg

H = 1000 mm

Ponte mobile

Mobile lift





SFL 5518 - 3000 kg
H min = 110 mm

SFL 5518T - 3000 kg
H min = 95 mm

SFL 5535 - 3500 kg
H min = 100 mm

SFL 5540 - 4000 kg
H min = 135 mm

Basso profilo
Low profile



SF 8502.54 - 5.500 kg alignment
SF 8065.2.60 - 6.500 kg alignment

SF 8065.1.60 - 6.500 kg service lift

Vertical rise lift with optional
hanging ramps

*Ponte a sollevamento verticale con
opzione rampe appese*



SF 5507 IF/5508 I - 3000 kg
SF 5509 IF/5510 I - 3500 kg



SF 6350 - 3500 kg **SF 6500** - 5000 kg
SF 6400 - 4200 kg **SF 6600** - 6000 kg



SQ 402 - 4000 kg
SQ 406L - 4000 kg
SQ 502L - 5000 kg
SQ 652L - 6500 kg
SQ 802 - 8000 kg



SQ 401LT - 4000 kg **SQ 402LT** - 4000 kg
SQ 502LLT - 5000 kg **SQ 406LLT** - 4000 kg
Sollevatore integrato Per assetto, con sollevatore integrato
Wheel free lift *Wheel alignment, incl. wheel free lift*



> **Attrezzature raccomandate**
 > **Recommended equipment**

SPACE

BMW

Equipement complet	Appareil de diagnostic	Appareil de diagnostic	Appareil de diagnostic	Appareil de diagnostic	Appareil de diagnostic
100	100	100	100	100	100

SPACE

CITROËN

Equipement complet	Appareil de diagnostic	Appareil de diagnostic	Appareil de diagnostic	Appareil de diagnostic	Appareil de diagnostic
100	100	100	100	100	100

SPACE

HYUNDAI

Appareil de diagnostic	Appareil de diagnostic	Appareil de diagnostic	Appareil de diagnostic	Appareil de diagnostic	Appareil de diagnostic
100	100	100	100	100	100

SPACE

Mercedes-Benz

SPHERE

Equipement complet	Appareil de diagnostic	Appareil de diagnostic	Appareil de diagnostic	Appareil de diagnostic	Appareil de diagnostic
100	100	100	100	100	100

SPACE

Mercedes-Benz

STABILE CARRO

Equipement complet	Appareil de diagnostic	Appareil de diagnostic	Appareil de diagnostic	Appareil de diagnostic	Appareil de diagnostic
100	100	100	100	100	100

SPACE

info pass

EQUIPEMENTS DE GARAGE

LABOR DE CONTRÔLE TECHNIQUE / TEST LABS

Equipement complet	Appareil de diagnostic	Appareil de diagnostic	Appareil de diagnostic	Appareil de diagnostic	Appareil de diagnostic
100	100	100	100	100	100

SPACE

Equipement complet	Appareil de diagnostic	Appareil de diagnostic	Appareil de diagnostic	Appareil de diagnostic	Appareil de diagnostic
100	100	100	100	100	100

SPACE

Appareil de diagnostic	Appareil de diagnostic	Appareil de diagnostic	Appareil de diagnostic	Appareil de diagnostic	Appareil de diagnostic
100	100	100	100	100	100







SPACE s.r.l. a s.u.

Via Sangano, 48
10090 Trana - Torino - ITALY
tel. +39-011-934.40.300
fax +39-011-933.88.64
e-mail: info@spacetest.com
www.spacetest.com

Member of VSG - Vehicle Service Group
a **DOVER** company

Le caratteristiche tecniche e gli allestimenti presentati in questo prospetto possono subire variazioni. Le immagini riprodotte non sono vincolanti.
Technical data and composition presented in this catalogue may vary. Pictures reproduced are only indicative.
Die techn. Daten und die Ausrüstungen, die in diesem Prospekt enthalten sind, können Änderungen erfahren. Deshalb sind die Abbildungen unverbindlich.
Les caractéristiques techniques et les compositions présentées dans ce prospectus peuvent subir des variations. Les images reproduites n'ont qu'une valeur indicative.
Las características técnicas y las composiciones ilustradas en este folleto pueden sufrir variaciones. Las imágenes propuestas son solamente indicativas.