

NEW
POWER

30
JAHRE
YEARS ANN

KSTOOLS

No Limits!



2 v 1



inkl.
z 25
vložki

1.0000+
vijaki

39,90

515.6500

5-krat hitreje kot ročno

TRANSFORMATOR MED IZVIJAČI

i 397
Dodatne informacije

P₁₀

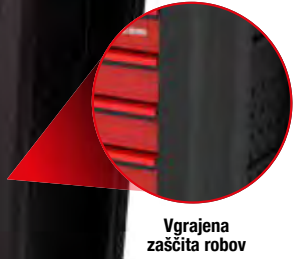
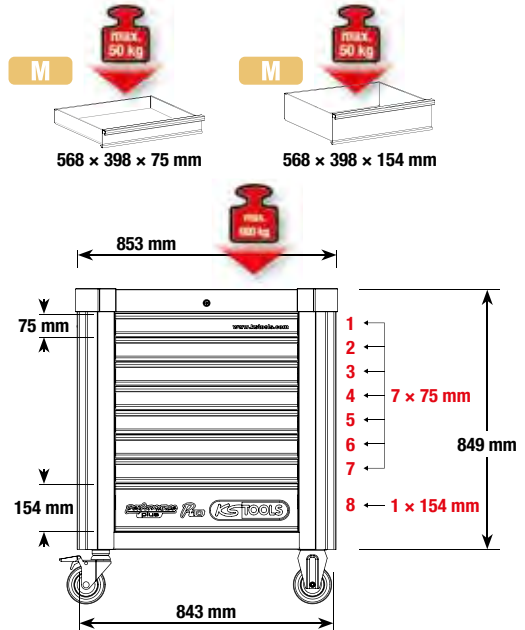

IZBERITE SVOJ PAKET MOČI >>>

810.7397

i 397
Dodatne informacije

sa Držalo za papirnate role s nosilec vtičnic Stabilen krogljčni ležaj Antistatična kolesa z zavoro

P₁₅

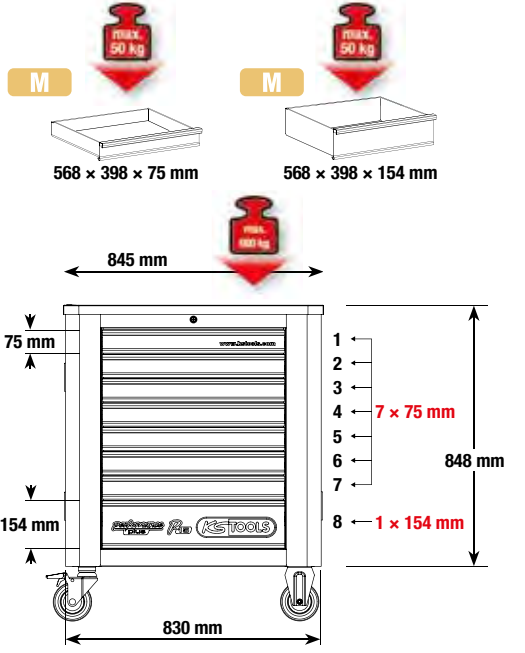

815.7397

ODLIČEN PAKET S 397 DELI.

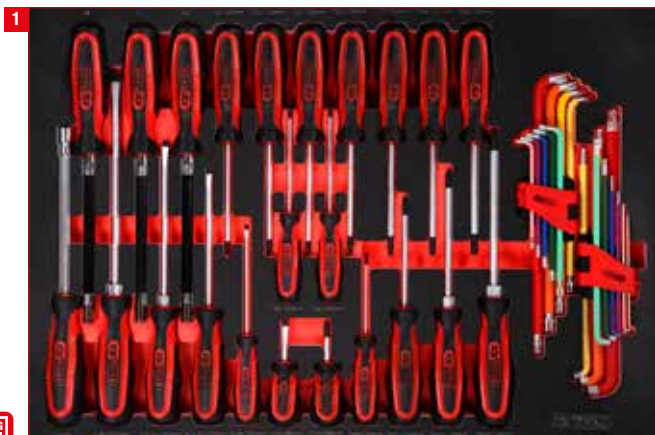

41 Komplet izvijačev

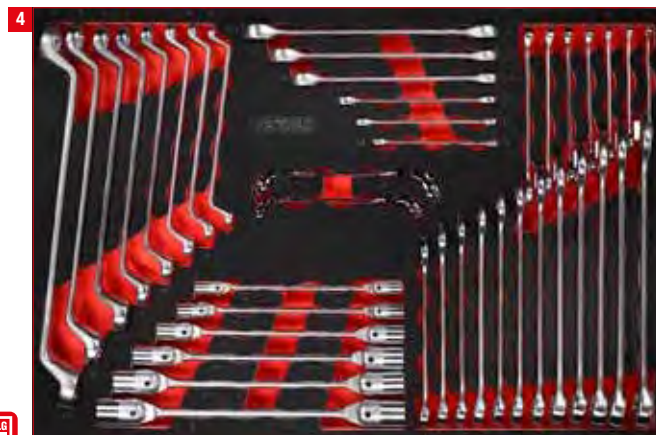

41 Komplet vijčnih ključev

2699,00

810.7397 P10 delavniški voziček s 397 orodji



111 1/4" + 3/8" + 1/2" komplet natičnih ključev

2799,00

815.7397 P15 delavniški voziček s 397 orodji



28 Komplet klešč in pil



43 Komplet za menjavo olja in pnevmatik



111 1/2" komplet vložkov za natični nastavek



22 Komplet kladiv in det

DOBRODOŠLI V KRALJEVSKEM



Dodatne informacije

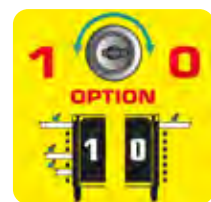

**Z 564
ORODJI**

3799,00



Vgrajena zaščita robov



s nosilec vtičnic



Stabilen kroglični ležaj



Antistatična kolesa z zavoro



Ključavnico je mogoče zakleniti

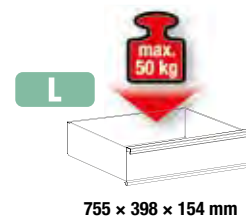
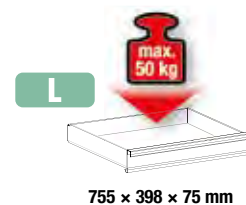
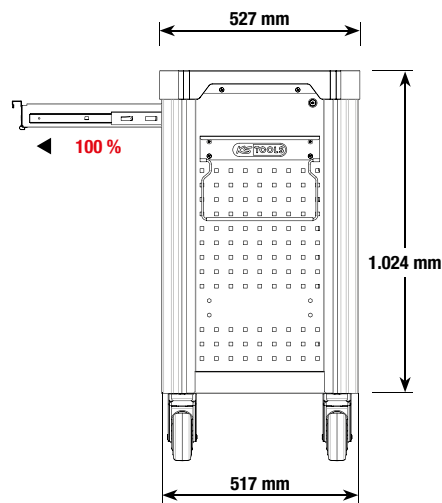
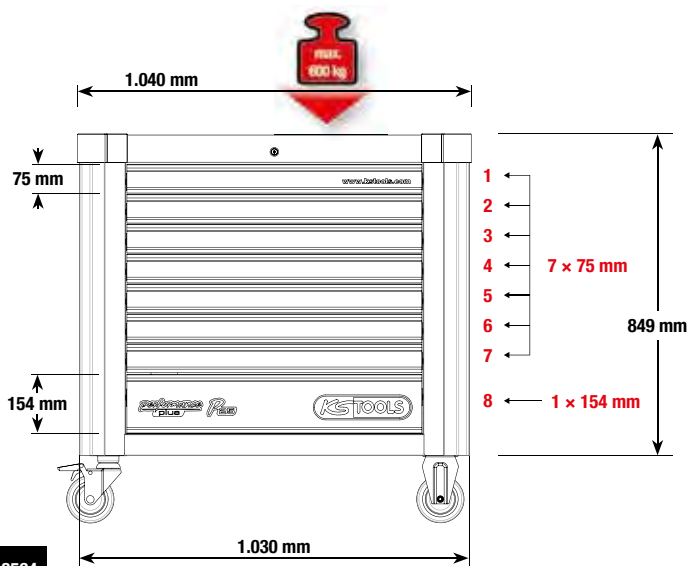

825.8564

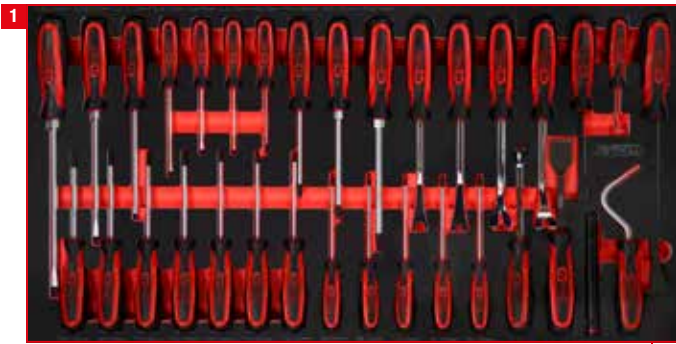

Komplet izvijačev

33



1/4" + 3/8" komplet natičnih ključev

213



1/2" komplet natičnih ključev

86



Komplet vijčnih ključev

57



Komplet vijčnih ključev

54

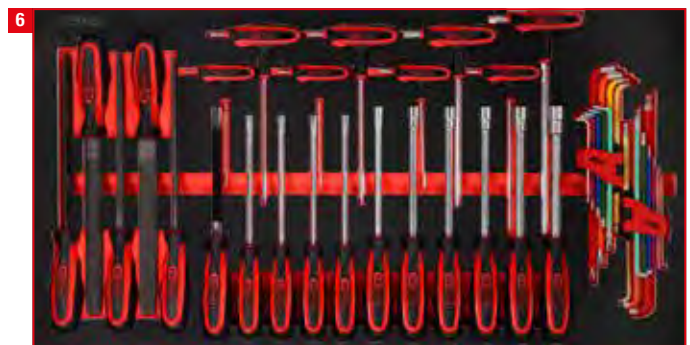

Komplet izvijačev in pil

42



Komplet klešč in merilnih orodij

39



Komplet, kladiv, dlet in natičnih nastavkov močnejše izvedbe

40

ECO *line*

S 7 predali in 215-delnim kompletom vrhunskih orodij

679,90

897.7215

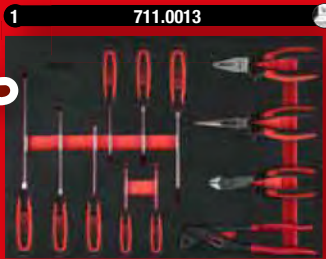

ZAČETNI PAKET - 215-DELNI



RACING *line*

S 7 predali in 215-delnim kompletom vrhunskih orodij

699,90

826.7215



Dodatne informacije

ECO *line*

S 7 predali in 515-delnim kompletom vrhunskih orodij

879,90

897.7515



UNIVERZALNI PAKET - 515-DELNI

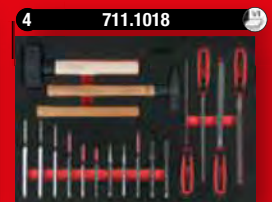
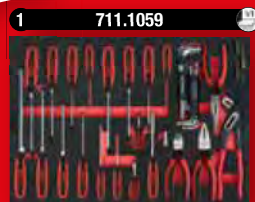

RACING *line*

S 7 predali in 515-delnim kompletom vrhunskih orodij

899,90

826.7515

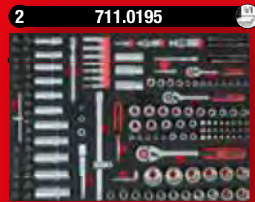

Dodatne informacije

ECO *line*

S 7 predali in 598-delnim kompletom vrhunskih orodij

1299,00

897.7598



MOČNOSTNI PAKET - 598-DELNI

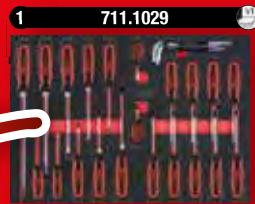

RACING *line*

S 7 predali in 598-delnim kompletom vrhunskih orodij

1349,00

826.7598

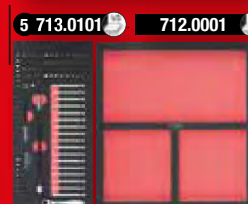
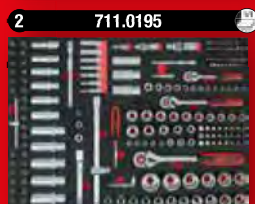

Dodatne informacije

KOLIKO AVTOMOBILOV JE LAHKO?

ECO *Line*



Dodatne informacije

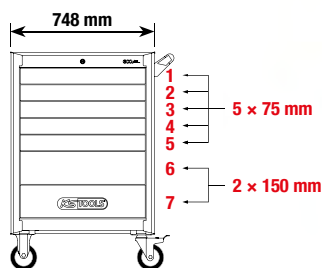
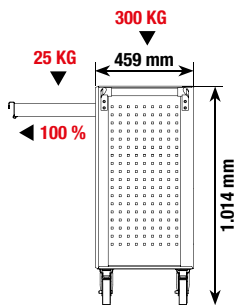

delovna plošča z 10 mm debelim penastim vložkom

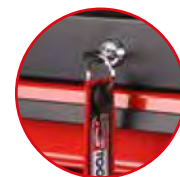

mogoče zakleniti z vgrajeno cilindrično ključavnico



Štirobna odprtina za dele pribora



s samodejnim uvlekom in funkcijo SOFT-CLOSE



2 x kotalna in vrtljiva zavora Ø koles: 125 mm

TEŽKA IZBIRA? IZBIRA S KAKOVOSTJO!

RACING *Line*

max. 350 kg

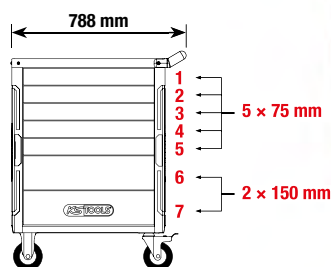
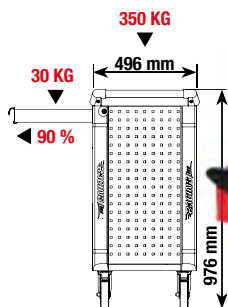

delovna plošča iz ABS s predali za majhne dele



mogoče zakleniti z vgrajeno cilindrično ključavnico



Štirobna odprtina za dele pribora



posamezni zaklep prepreči nehoteno odpiranje



2 x kotalna in vrtljiva zavora Ø koles: 125 mm

Tehnični podatki:	Eco Line 897.0007	Racing Line 826.0007
Skupna nosilnost:	300,0 kg	350,0 kg
Obremenljivost na predal:	25,0 kg	30,0 kg
samodejnim uvlekom in funkcijo SOFT-CLOSE:	✓	✗
Premer kolesa :	125,0 mm	125,0 mm
Nastavnik kolesa:	✓	✓
S centralnim zaklepom:	✓	✓
Posamezni zaklep:	✗	✓
Višina:	1014,0 mm	976,0 mm
Širina:	748 mm	788 mm
Globina:	459,0 mm	496,0 mm
Notranja mera predala:	565 x 395 mm	565 x 395 mm
za zaščito vogalnih robov iz poliuretana:	✗	✓
Štirobna odprtina za dele pribora:	✓	✓
Število predalov:	7	7
debelina pločevine:	0,8 mm	0,9 mm
prijemne letve:	✓	✓
Izvlak predala:	100 %	90 %
Delovna plošča z žepi za majhne dele:	✗	✓
Delovna plošča s plastičnimi vložki:	✓	✗
kroglično uležajeno vodilo predala:	✓	✓
s stranskim kovinskim ročajem:	✓	✓



Dodatne informacije



od **22,90**



517.0048



8 · 9 · 10 · 11 · 13
· 14 · 17 · 19 mm

22,90 €

517.0052



8 · 9 · 10 · 11 · 12
· 13 · 14 · 15 · 16
· 17 · 18 · 19 mm

42,90 €

- Profil FlankTraction
- položaj odprtine 15° ukrivljen
- obroč 15° ukrivljen
- polirane glave
- mat satiniran



Dodatne informacije



109,50



517.0043

6 · 7 · 8 · 9 · 10 · 11 · 12 · 13 · 14 · 15 · 16 · 17 · 18 · 19 · 20 · 21 · 22 · 24 · 27 · 30 · 32 mm



Dodatne informacije



14,90

522.1922



Dodatne informacije

OBRAČALNA RAGLJA 4 V 1

19,90



503.4565

10 × 13 × 17 × 19 mm



Dodatne informacije

VEČNAMENSKI TALENT

Enoročni večnamenski ključ



33,90

114.0055



8 · 9 · 10 · 11 · 12 · 13 · 14 · 15 · 16 · 17 · 18 · 19 · 20 · 21 · 22 · 23 · 24 · 25 · 26 · 27 · 28 · 29 · 30 · 31 · 32 mm



Dodatne informacije

VSEZNALEC

168,90

GEAR plus[®] RING STOP

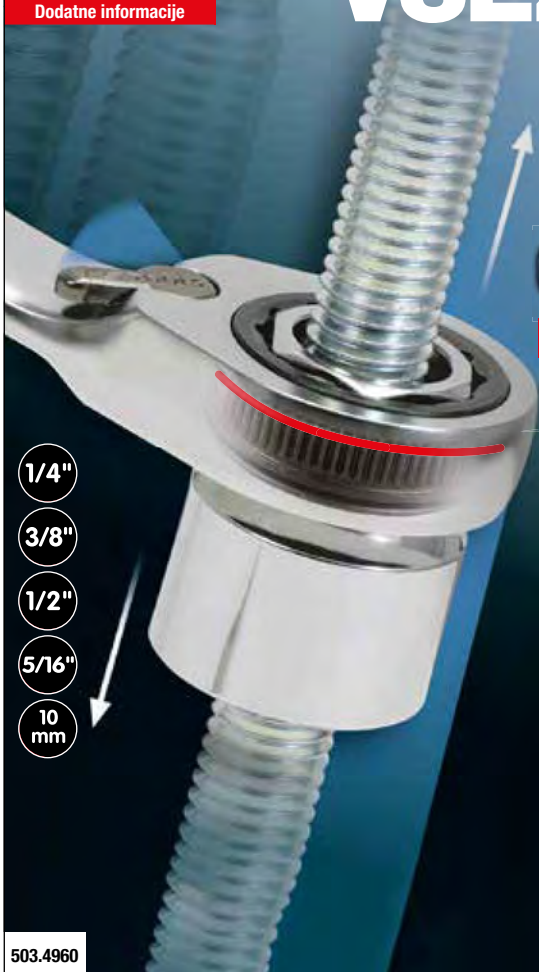

503.4960

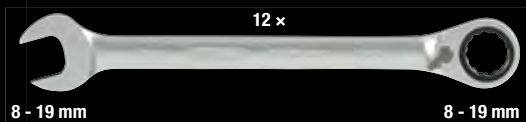
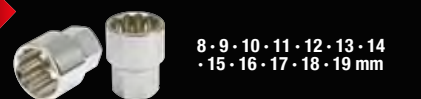

LET'S TALK ABOUT SIX!

Vemo, kaj zmoremo. In ker točno vemo, kako dober je naš novi obseg pošastnih ragelj, je samoumevno, da vam lahko zagotovimo **garancijo** za vsak model. Ne 2 ali 3 leta.

Ne, točno **10 let!** Tako, da je garancija prav tako vrhunska kot naše pošastne raglje!



INOVATIVEN MECHANIZEM RAGLJE

Naša inovativna tehnologija z dvojnimi zatičem preprečuje zdrs mehanizma raglje. Posebne mazalne masti poskrbijo za dolgo življenjsko dobo mehanike.

ZAPRT MECHANIZEM V GLAVI RAGLJE

Natančna izdelava orodja z minimalnimi dovoljenimi odstopanji v kombinaciji s posebnim zapiranjem zagotavlja zaščito pred prdiranjem nečistoč.



ZAKLEP NA ŠTIRIROBNEM NASTAVKU

Izredno zanesljivo: Vložki vtičnega ključa so varno pritrjeni na štiriobnem nastavku in skoraj nimajo zračnosti.



ENKRATNO

Vsak izdelek je tako edinstven kot vi, preverjen je s posamezno serijsko številko.

Da boste lahko vašo pošastno ragljo dolgo uporabljali! Ampak najboljše za celo življenje!

Ergonomsko oblikovan večkomponentni ročaj za hitro in varno delo.

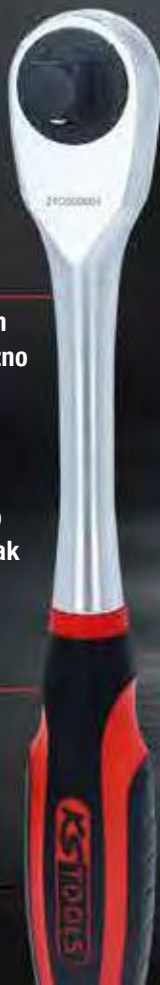

15 % OŽJA

V nekaterih delovnih situacijah, je pomemben vsak milimeter. Glave naših novih ragelj so približno 15% ožje v primerjavi s standardnimi modeli. Odlično, ko postane ozko!



10 % LAŽJA

Nove pošastne raglje podjetja KS TOOLS dokazujejo, da veliko moči ne tehta veliko. Vaša prednost: Učinkovito in neutrudljivo delo.

NAJBOLJŠE, KAR SMO JIH KDAJ IZDELALI!



1 **29,90** **1**
Dodatne informacije



935.1490 106 g 125 mm **>110 Nm**

2 **29,90** **1**
Dodatne informacije



935.1495 106 g 125 mm **>100 Nm**

3 **39,90** **1**
Dodatne informacije



>365 Nm 935.3890 227 g 199 mm

**ZAGOTOVLJENO:
6 RAGELJ
ZA CELO
ŽIVLJENJE!**



4 **49,90** **1**
Dodatne informacije



>950 Nm 935.1290 567 g 275 mm

5 **69,90** **1**
Dodatne informacije



>950 Nm 935.1295 757 g 425 mm

6 **99,90** **1**
Dodatne informacije



TELESKOPSKA



635 607 582 557 533 508 482 457 431 406 mm **>950 Nm** 935.1285 1.280 g 406 - 635 mm

NAŠ NAJBOLJ PRODAJAN IZDELEK

i  **48**
Dodatne informacije



27,90

1/4"		○ 4 - 4,5 - 5 - 5,5 - 6 - 7 - 8 - 9 - 10 - 11 - 12 - 13 mm
		

1/4"
917.0648



i  **195**
Dodatne informacije



109,90

PROĐANA VEČ KOT MILIJON KRAT!



	○ 4 - 4,5 - 5 - 5,5 - 6 - 7 - 8 - 9 - 10 - 11 - 12 - 13 - 14 mm
1/4"	○ 6 - 7 - 8 - 9 - 10 - 11 - 12 - 13 mm
	
3/8"	○ 10 - 11 - 12 - 13 - 14 - 15 - 16 - 17 - 18 - 19 mm
	○ 10 - 11 - 12 - 13 - 14 - 15 mm
1/2"	○ 10 - 11 - 12 - 13 - 14 - 15 - 16 - 17 - 18 - 19 - 20 - 21 - 22 - 23 - 24 - 27 - 30 - 32 mm
	○ 16 - 17 - 18 - 19 - 22 mm
1/4" 5/16"	

1/4" 3/8" 1/2"

917.0795 

VEČ NE GRE!



Dodatne informacije



ponikljan



1/4"		4 - 4,5 - 5 - 5,5 - 6 - 7 - 8 - 9 - 10 - 11 - 12 - 13 - 14 mm
1/4"		6 - 7 - 8 - 9 - 10 - 11 - 12 - 13 - 14 - 15 mm
3/8"		10 - 11 - 12 - 13 - 14 - 15 - 16 - 17 - 18 - 19 mm
3/8"		10 - 11 - 12 - 13 - 14 - 15 mm
1/2"		10 - 11 - 12 - 13 - 14 - 15 - 17 - 18 - 19 - 20 - 21 - 22 - 24 - 27 - 30 - 32 mm
1/2"		17 - 19 - 22 mm
1/4"		
5/16"		
12 x		8 - 9 - 10 - 11 - 12 - 13 - 14 - 15 - 16 - 17 - 18 - 19 mm

174,⁹⁰

917.0216

1/4"

3/8"

1/2"



Dodatne informacije

ODLIČEN REŠEVALEC TEŽAV!

16 x		19 - 21 - 22 - 23 - 24 - 26 - 27 - 29 - 30 - 32 - 35 - 36 - 38 - 41 - 46 - 50 mm
3 x		100 - 200 - 400 mm
1 x		450 mm
1 x		500 mm



219,⁹⁰

500 mm

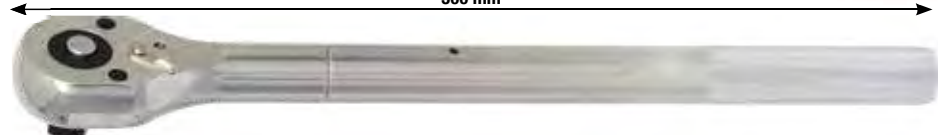

3/4"

911.0721



97



Dodatne informacije

GENIALNO UNIVERZALEN!



ponikljan

5°

R
L

1/4"		4 - 4,5 - 5 - 5,5 - 6 - 7 - 8 - 9 - 10 - 11 - 12 - 13 mm
1/2"		10 - 11 - 12 - 13 - 14 - 15 - 16 - 17 - 19 - 20 - 21 - 22 - 24 - 27 - 30 - 32 mm
12 x		8 - 9 - 10 - 11 - 12 - 13 - 14 - 15 - 16 - 17 - 18 - 19 mm
7 x		

1/4" 1/2"

174,90

917.0797



127



Dodatne informacije

KOVČEK ZA STROKOVNJAKE!



4 x



8 x 8 - 9 - 10 - 11 - 13 - 14 - 17 - 19 mm



1/4"		4 - 4,5 - 5 - 5,5 - 6 - 7 - 8 - 9 - 10 - 11 - 12 - 13 - 14 mm
1/2"		10 - 13 - 14 - 16 - 17 - 18 - 19 - 20 - 22 - 24 - 27 - 30 - 32 mm

1/4" 1/2"

372,90

911.0727



14



Vse cene v EUR brez DDV-jem veljajo do 30.9.2023

i  **99**
Dodatne informacije

ZAKLADNICE!

i  **99**
Dodatne informacije



 1/4"	4 - 5 - 6 - 7 - 8 - 9 - 10 - 11 - 12 - 13 - 14 mm
 1/2"	13 - 15 - 17 - 18 - 19 - 20 - 21 - 22 - 24 - 27 - 30 - 32 mm



**VI
IZBIRATE!**

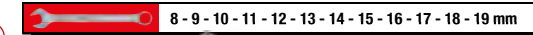
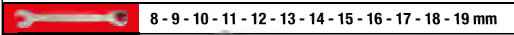

599,⁹⁰

1/4" 1/2"



519,⁹⁰

1/4" 1/2"

918.0100 

918.0200 

i  **40**
Dodatne informacije

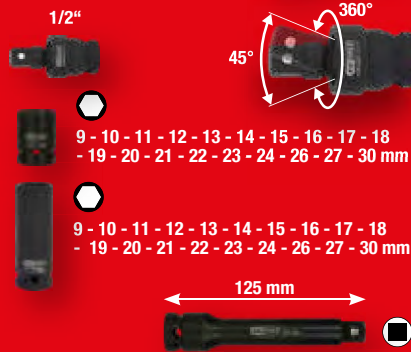

9 - 10 - 11 - 12 - 13 - 14 - 15 - 16 - 17 - 18 - 19 - 20 - 21 - 22 - 23 - 24 - 26 - 27 - 30 mm

9 - 10 - 11 - 12 - 13 - 14 - 15 - 16 - 17 - 18 - 19 - 20 - 21 - 22 - 23 - 24 - 26 - 27 - 30 mm

125 mm

1/2"

114,⁹⁰

515.0065



ZELO NATANČNI MOMENTNI KLJUČI



Dodatne informacije



ERGOTORQUE PRECISION



Mikrometerska lestvica



Lestvica s povečevalom



Z izjavo o skladnosti glede umerjanja
DIN EN ISO 6789
Potrdilo
Natančnost ±0,3%



R

L

od **99,90**

			Nm	Delitev Nm	Lbf-ft	
516.1402		1/4"	1-5	0,10	0,8 - 3,6	99,90 €
516.1412		1/4"	5-25	0,10	0,8 - 18	99,90 €
516.1422		3/8"	10-50	0,25	4 - 37	99,90 €
516.1432		1/2"	20-100	0,50	8 - 75	110,90 €
516.1442		1/2"	40-200	1,00	15 - 150	110,90 €
516.1472		1/2"	60-320	1,00	45 - 236	124,90 €
516.1482		1/2"	80-420	1,00	60 - 310	135,90 €
516.1493		3/4"	150-750	10,00	150 - 550	588,90 €
516.1495		1"	200-1000	20,00	220 - 730	673,90 €



Dodatne informacije

NAJPOMEMBNEJŠIH 22 V ENEM KOMPLETU



12,90

151.4000

1,27 - 1,5 - 2 - 2,5 - 3 - 3,5 - 4 - 4,5 - 5 - 6 - 7 - 8 - 10 mm

TB10 - TB15 - TB20 - TB25 - TB27 - TB30 - TB40 - TB45 - TB50

i  **34**
 Dodatne informacije

SEM VIJAK, VZEMITE VEN!

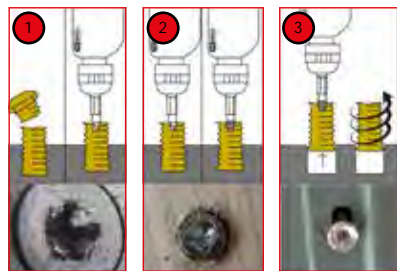

44,90

TORION power



9 x		TE10 - TE15 - TE20 - TE25 - TE27 - TE30 - TE40 - TE50 - TE55
9 x		1,5 - 2 - 2,5 - 3 - 4 - 5 - 6 - 8 - 10 mm
7 x		1,5 - 2 - 2,5 - 3 - 4 - 5 - 6 mm
7 x		T10 - T15 - T20 - T25 - T27 - T30 - T40

150.7060    **1/4" + 10 mm Komplet Torx in inbus izvijačev za vijake**

i  **32**
 Dodatne informacije

25 mm
50 mm

1 x		50 mm
1 x		25 mm
3 x		PH1 - PH2 - PH3
6 x		2 x PZ1 - 2 x PZ2 - 2 x PZ3
3 x		5,5 - 6,5 - 8 mm
3 x		4 - 5 - 6 mm
15 x		2 x TB10 - 3x TB15 - 2x TB20 - 3x TB25 - 3x TB30 - 2 x TB40











911.2060 **8,90**





i  **208**
 Dodatne informacije

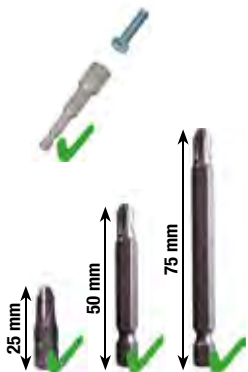

39,90

1/4"		1/4": 205 mm
138 x		25 mm 
29 x		50 mm 
18 x		75 mm 
20 x		4 - 5 - 6 - 7 - 8 - 9 - 10 - 11 - 12 - 13 mm 5/32" - 3/16" - 7/32" - 1/4" - 9/32" - 5/16" - 11/32" - 3/8" - 7/16" - 1/2"
1 x		1/4": 50 mm
1 x		1/4"



i  **32**
 Dodatne informacije

TORION power

+30%

1 x		1/4"
1 x		1/4"
4 x		3 - 4 - 5 - 6 mm
4 x		PH1 - 2 x PH2 - PH3
4 x		PZ1 - 2 x PZ2 - PZ3
4 x		3 - 4 - 5 - 6 mm
7 x		T10 - T15 - T20 - T25 - T27 - T30 - T40
7 x		TB10 - TB15 - TB20 - TB25 - TB27 - TB30 - TB40

911.3030 **9,90**



i **1**
Dodatne informacije

1 ALI

2

2 V 1

1/4"

85 mm

514.1126

i **1**
Dodatne informacije

z zgibom

1/4"

90 mm

20°

10,90

514.1136

i **27**
Dodatne informacije

LED

1/4"

eMONSTER

ENKRAT DOTAKNJEJ, ZA VEDNO ZAPELJAN.

34,90

515.3600

max 6 Nm

max 4 Nm

max 2 Nm

4 x		3,0 - 4,0 - 5,0 - 6,0 mm
4 x		3,0 - 4,0 - 5,0 - 6,0 mm
5 x		PH0 - PH1 - PH2 - PH3
4 x		P20 - PZ1 - PZ2 - PZ3
4 x		T10 - T15 - T20 - T25
4 x		#0 - #1 - #2 - #3
1 x		PH1
1 x		50 mm
1 x		Max. 6 Nm

3,6 V

1.500 mAh

300 rpm

USB-C

2 x LED

TRANSFORMATOR MED IZVIJAČI



eMONSTER

Visoka vrtilna
frekvenca
210 vrt./min,
5 x hitrejša od
ročnega
privijanja.

praktičen prikaz stanja
napoljenosti baterije
s 3 LED diodami

ojačan
menjalnik



Naprava 2 v 1 z dobrim razmerjem med zmogljivostjo in velikostjo, idealna za delo nad glavo in v ozkih prostorih.

magnetni
nastavek za
vložke



predizbira navora nastavljava
v 10 korakih



Prekomerno zategovanje vijakov
je preprečeno s samodejnim
zaklepanjem motorja, ko je navor
presežen.

vgrajena luč



izboljššan oprijem
za udobje



1.3 Ah Baterija
s časom delovanja
za

1000+
vijakov

Visoko zmogljivostna
baterija LI-ION je prav
tako hitro napolnjena in
pripravljena za uporabo
zahvaljujoč USB B-C
priključku.



3.6 V	1.500 mAh	210 rpm	USB-C	1 x LED

i **27**
Dodatne informacije



vklij.
z 25
vložki

39,90

515.6500



51



Dodatne informacije

VSESTRANSKO ORODJE



max. 31500 U/min



max. 22500 U/min



max. 13500 U/min

**eMONSTER****49,⁹⁰**

515.3990

1 Vrtanje



2 Čiščenje



3 Brušenje



23x



Ø 20 mm

4 Graviranje



1x



1x



1x



1x

5 Ločevanje



8x

Ø 24 mm

0,8 mm

6 Poliranje



4x

Ø 13 mm

Ø 25 mm



Politura

eMONSTER komplet
večnamenskih orodij za
akumulatorje s 50 deli pribora



50



Dodatne informacije

ZA KASNEJŠI DOKUP



komplet pribora, 50-delni

9,⁹⁰

515.3992

i  **5**
Dodatne informacije

ERGOTORQUE plus

9,90

159.0005  



PH1
PH2
6,5 mm
5,5 mm
4 mm

i  **39**
Dodatne informacije

	50 mm
	3 - 4 - 5,5 - 6 - 6,5 - 8 - 10 mm
	PH0 - PH1 - PH2 - PH3
	PZ0 - PZ1 - PZ2 - PZ3
	2 - 2,5 - 3 - 4 - 5 - 6 - 8 mm
	T10 - T15 - T20 - T25 - T27 - T30 - T40
	TB10 - TB15 - TB20 - TB25 - TB27 - TB30 - TB40

ERGOTORQUE plus

50,90

159.0100



i  **13**
Dodatne informacije

ERGOTORQUE plus

1/4"

67,90

151.1150



5 x		3,5 - 5,5 - 7 - 8 - 10 mm
5 x		PH0 - PH1 - PH2 - PH3 - PH4
1 x		6 mm
1 x		PH2
1 x		1/4"



i  **13**
Dodatne informacije

12 IN ONE

14,90

159.2035    







240 mm

12 v 1 nastavek za izvijač z ragljo

IMAMO CELOTNO PONUDBO ZAKOVIC!

A

13

Dodatne informacije

A

22,90

150.9605

B

12

Dodatne informacije

B

49,90

150.9850

C

12

Dodatne informacije

C

59,90

150.9820

		Aluminij 2,4 mm	Aluminij 3,2 mm	Aluminij 4,0 mm	Aluminij 4,8 mm	Aluminij 6,4 mm	Jeklo 2,4 mm	Jeklo 3,2 mm	Jeklo 4,0 mm	Jeklo 4,8 mm
A	150.9605	✓	✓	✓	✓	✗	✓	✓	✓	✓
B	150.9850	✓	✓	✓	✓	✗	✓	✓	✓	✓
C	150.9820	✓	✓	✓	✓	✗	✓	✓	✓	✓
D	150.9805	✓	✓	✓	✓	✓	✓	✓	✓	✓
E	150.9625	✓	✓	✓	✓	✓	✓	✓	✓	✓
F	150.9630	✓	✓	✓	✓	✓	✓	✓	✓	✓

i **15** **D**
 Dodatne informacije



D

67,90

150.9805

i **13** **E**
 Dodatne informacije



E

27,90

150.9625

i **17** **F**
 Dodatne informacije



F

174,90

150.9630



M3 M4 M5 M6 M8 M10



eno- ali dvoročno delovanje

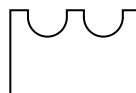

klešče za pločevino



dolžina mm



vrtljiva glava



v kovčku

M3	M4	M5	M6	M8	M10	eno- ali dvoročno delovanje	klešče za pločevino	dolžina mm	vrtljiva glava	v kovčku
X	X	X	X	X	X	👤	X	210	X	X
✓	✓	✓	✓	X	X	👤	✓	230	X	✓
✓	✓	✓	✓	X	X	👤	✓	260	✓	✓
✓	✓	✓	✓	✓	✓	👤👤	✓	260	X	✓
X	X	X	X	X	X	👤👤	X	330	X	X
✓	✓	✓	✓	✓	✓	👤👤	X	510	X	✓

i   **1**
Dodatne informacije



od 10,90

115.2011	175 mm	7"	10,90 €
115.2010	240 mm	10"	12,90 €
115.2012	300 mm	12"	15,90 €
115.2016	415 mm	16"	31,90 €





i   **1**
Dodatne informacije

BOLJŠI STRANSKI REZALNIK





-64 HRC
Ø max. 5 mm
8" / 215 mm

16,90

119.0005



i   **4**
Dodatne informacije



110,90

19 - 60 mm

165 mm

119.2055

CrV	DIN 5254 A	DIN 5254 B	DIN 5256 C	DIN 5256 D
-----	------------	------------	------------	------------

i   **4**
Dodatne informacije

124,90

40 - 100 mm

230 mm

119.2060



i   **20**
Dodatne informacije

VARNOST NA PRVEM MESTU



60 - 100 mm 40 - 85 mm

49,90



0° 15° 45° 90°

90° 45° 15° 0°



500.1350 Komplet varovalnih klešč s funkcijo raglje



Dodatne informacije

ODLIČNO NATANČNO ORODJE!



Dodatne informacije

24,90

Komplet orodij za fino mehaniko



99,90



1 x		120 mm	1 x		160 mm
1 x		120 mm	3 x		PH00 - PH0 - PH1
1 x		120 mm	3 x		2,0 - 2,4 - 3,0 mm

500.7220

2 x		125 - 130 mm
1 x		100 mm
1 x		100 mm
1 x		125 mm
1 x		150 mm
1 x		145 mm

500.7190

3 x		PH00 - PH0 - PH1
4 x		1,4 - 2,0 - 2,4 - 3,0 mm
7 x		T6 - T7 - T8 - T9 - T10 - T15 - T20

Dodatne informacije

s stabilno nastavitveno konico, podobno zarisovalni igli

S TOGO MAGNETNO GLAVO

5,90

2 v 1 teleskopski magnetni nosilec s čistilnimi in nastavitvenim orodjem za pralne šobe

550.1001

Dodatne informacije

s tanko čistilno palico

S FLEKSIBILNO MAGNETNO GLAVO

7,90

2 v 1 teleskopski magnetni nosilec s čistilnimi in nastavitvenim orodjem za pralne šobe

550.1023

Dodatne informacije

9,90

LED

Prilagodljivo inšpekcijsko ogledalo z osvetlitvijo

550.1136

i **4**
Dodatne informacije

9,90

550.1045

i **9**
Dodatne informacije

19,90

550.1070

i **1**
Dodatne informacije

8,90

Piezo

115 mm

960.1110

i **11**
Dodatne informacije

29,90

200 mm

Piezo

20 mm 33 mm 1,6 mm 3,5 mm 4,5 mm 5 mm 30 mm

95 mm 95 mm

0 40 mm

Komplet za mikro spajkanje

960.1160

i **5**
Dodatne informacije

29,90

Nastavitev temperature:
1≈50 °C/2≈100 °C/3≈200 °C/
4≈350 °C/5≈550 °C/6≈650 °C

260 mm

1 2 3 4 5 6

1 max. 450°C
2 max. 650°C

Področja uporabe: odstranjevanje barve, spajkanje cevi, krčenje PVC-ja, varjenje in upogibanje plastike, sušenja, taljenje itd.

960.1190

i **1**
Dodatne informacije

134,90

IP 34

15+1 m

3x 1,5 mm²

230 V 50 Hz

1000/3000 W

10 A

180°

150.4217

i **12**
Dodatne informacije

9,90

145 mm

5,0 x 1,0 mm
5,0 x 1,0 mm
3,0 mm
3,0 mm
5,0 mm
5,0 mm
3,0 mm
2,0 mm
2,0 mm
5,0 mm
5,0 mm
5,0 mm

140.3050

i **5**
Dodatne informacije

29,90

200 mm

140.3000



Dodatne informacije



SKORAJ VSESTRANSKI



Št.	Opis
1	Gumb za prižig
2	Funkcijsko stikalo
3	Kapacitivnostno stikalo
4	Stikalo za osvetlitev
5	LCD zaslon
6	Območje senzorja NCV
7	Testni vodi



49,90



Simbol	Opis
	Enosmerna napetost
	AC napetost
	Indikator samodejnega izklopa
	Indikator prazne baterije
	Diodni način
	Prehod
	Zmogljivost
	Razmerje merilnika moči
HOLD	Funkcija zadrževanja podatkov
V, mV	Enota za napetost: volt, milivolt
mF, µF, nF	Enota zmogljivosti
MΩ, KΩ, Ω	Enota upora
NCV	Brezkontaktna indukcija napetosti
Live	Testiranje živih linij
KHz, Hz	Enota frekvence
°C/°F	Celzij/Fahrenheit



- samodejna identifikacija izmenične napetosti, enosmerne napetosti, upornosti
- Preverjanje električnih kablov
- preverjanje indukcijske napetosti brez dotikanja
- velik barvni prikazovalnik LCD 3,5"

- komplet merilnih napeljav s kontrolno konic (rdeča/črna)
- vključno s 700 mAh litij-ionskim akumulatorjem
- vključno z robustnim zaščitnim ovojem
- s praktično torbo

150.1765

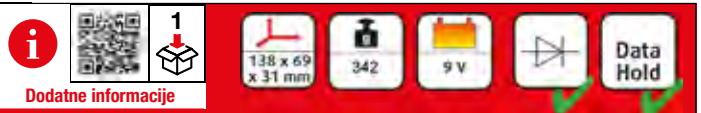

Dodatne informacije



ODLIČNA CENA

19,90

150.1495

i  **1**
 Dodatne informacije

22,90

NATANČEN IN KOMPAKTEN



- z določljivo momenta
- merilne tirnice v mm in colski delitvi
- s tabelo z navoji

300.0510

i  **1**
 Dodatne informacije

24,90

POPOLNOMA DIGITALNO!



- z nastavitvenim vijakom in fino nastavitvijo kolesčka
- za notranja, zunanja, stopenjska in globinska merjenja

300.0532

i  **1**
 Dodatne informacije

SOME LIKE IT HOT, SOME NOT!

Infrardeči termometer, od -38° do 520°



49,90

150.3040

i  **4**
 Dodatne informacije

56,90



550.1290

Refraktometer - optična testna naprava za baterijsko tekočino in protizmrazovalno zaščito

i  **4**
 Dodatne informacije

67,90



550.1285

Refraktometer - optična testna naprava za baterijsko tekočino, protizmrazovalno zaščito in dodatke AdBlue®

i  **4**
 Dodatne informacije

19,⁹⁰

11 x 115 mm
 15 x 185 mm
 18 x 320 mm
 18 x 470 mm

Komplet vzvodnih jeklenih ročic

911.8100

i  **4**
 Dodatne informacije

900 mm
 0°
 45°
 75°
 90°

179,⁹⁰

Komplet vzvodnih jeklenih ročic

911.8410

i  **22**
 Dodatne informacije

Komplet univerzalnih hidravličnih smenalnikov 2+3 ročice

- manjša nevarnost zdrsa zaradi samodejno zapirajočih vlečnih nosilcev
- na voljo 8 različic smenalnikov
- izjemno robustno vreteno z induktivno kaljenim navojem
- majhna uporaba sile
- posebno orodno jeklo

304,⁹⁰

700.1200

10t.

20 - 35 - 85 mm
 235 mm
 185 mm
 10 t, AG 1.1/2" x 16G
 225 mm
 170 mm
 120 mm
 Ø max. 100 mm

i  **25**
 Dodatne informacije

ODVIJE!

Komplet orodij za rezanje navojev

- obsežna sestava kompleta
- za odstranjevanje prelomljenih navojnih sornikov in vijakov
- brez poškodovanja navoja
- samo manjša razširitev navojnih sornikov s posebnimi profiliranimi odvijalnimi zatiči

150.1305 M5 - M6 - M8 - M10 - M12 - M14 - M16

Führungshülse drill guide	Hülse Innen- Ø mm guide	vorböhren Ø mm pre-drilling	aufbohren re-drilling	Stift pin	Art. Nr. No. Pin	Mutter D nut D	Art. Nr. nut D	Stift + Mutter pin + nut
150.0591	4,0 / 3,2	3,2	-	3,2	150.0521	SW 10	150.0511	150.0515
150.0592	4,8 / 3,2	3,2	-	3,2	150.0521	SW 10	150.0511	150.0515
150.0593	4,8 / 3,2	3,2	4,8	4,8	150.0522	SW 11	150.0512	150.0515
150.0594	4,8 / 3,2	3,2	4,8	4,8	150.0522	SW 11	150.0512	150.0515
150.0595	6,0 / 4,8	4,8	6,4	6,4	150.0523	SW 13	150.0513	150.0515
150.0596	7,0 / 4,8	4,8	6,4	6,4	150.0523	SW 13	150.0513	150.0515
150.0597	7,0 / 4,8	4,8	8,0	8,0	150.0524	SW 14	150.0514	150.0515
150.0598	7,0 / 4,8	4,8	8,7	8,7	150.0525	SW 17	150.0515	150.0515
150.0599	8,0 / 6,5	6,4	8,7	8,7	150.0525	SW 17	150.0515	150.0515
150.0610	8,5 / 6,5	6,4	8,7	8,7	150.0525	SW 17	150.0515	150.0515

39,⁹⁰

A B C D



Dodatne informacije

49,90

Komplet izvijačev za stebelne vijake

- zunanji šestrobri nastavek 21,0 mm
- s funkcijo za napenjanjem v desno in levo
- varen oprijem s po 3 kotalnimi valji
- privijanje in odvijanje brez zamudnega protiprivijanja dveh matic na vijaku
- primeren tudi za predolge stebelne vijake – ker je neprekinjeno prevrtan



M5 M6 M7 M8 M10 M12 M14

152.1101 M5 - M6 - M7 - M8 - M10 - M12 - M14



Dodatne informacije

VSI RADI NOSIJO!

24,90

EN388
4131X

Mikro fino pletenje

	Velikost	Vsebina
310.0490	7	12 parov
310.0491	8	12 parov
310.0470	9	12 parov
310.0475	10	12 parov
310.0480	11	12 parov



Dodatne informacije

DIZAJN PLAMEN



49,90

310.0155



Dodatne informacije

3,90

CE
EN 166



310.0120



Dodatne informacije

DIZAJN JEKLO



49,90

310.0195



EN 379 1/1/1/2



EN 175

Tehnični podatki:

Izbira barve:	brezstopenjsko nastavljev DIN 9-13
Standardna nastavek svetlobe:	DIN 4
Odzivni čas preklopa:	1/25.000 s
	0,2–0,8 s časovna zamuda (nastavljivo)
UV/IR zaščita:	po EN169 / do DIN 16
Delovna temperatura:	-5°C do +55°C
Skladiščna temperatura:	-20°C do +70°C
Električna napetost:	s solarnimi celicami
Višina:	220 mm
Širina:	200 mm
Dolžina:	295 mm
Teža:	480 g
Mere kasete:	110 x 90 x 9 mm
Okence:	92 x 42 mm

i   **1**
Dodatne informacije

Univerzalen razpršilnik tlačne črpalke

- iz visokokakovostnega polietilena
- za različne kemikalije, kot so pralna in čistilna sredstva, topila itd.
- ni primerna za čistilo za zavore
- razpršilna glava iz medenine, ki jo je mogoče nastaviti in zakleniti
- tesnila iz vitona
- primerno za dela nad glavo

od 14,90

150.8251	1 L	14,90 €
150.8252	2 L	19,90 €





i   **1**
Dodatne informacije



17,90

17 x / 2,5cm

8 x / 2,5cm

325 mm

907.2113 Japonska vlečna žaga, dvostransko ozobljena

i   **7**
Dodatne informacije

7,90



TiA.1040-02R TiA.1040-04R TiA.1040-10R
 TiA.1040-12R TiA.1040-17R

FUGENFIX®

116.1050 FUGENFIX komplet silikonskih strgal in snemalnikov

i   **2** **1/2"**
Dodatne informacije



270 mm

90 mm

1" - 3/4" - 1/2" - 3/8"

19,90

Komplet univerzalnih stopenjskih ključev 3/8" - 1"

130.3000 3/8" 1/2" 3/4" 1"

i   **1**
Dodatne informacije



39,90

70 mm

12 - 35 mm

180 mm

12 - 35 MM



129,90

110 mm

28 - 67 mm

250 mm

28 - 67 MM

Rezilo za cevi z ragljo

104.5060 Inox Steel

104.5050 Inox Steel

i  **1**
 Dodatne informacije



100 mm
39 mm

3,90

907.2240

i  **1**
 Dodatne informacije



78 mm
193 mm

10,90

907.2105

i  **2**
 Dodatne informacije

14,90



155 mm
97 mm



907.2172 **Komplet zložljivih nožev**

i  **3**
 Dodatne informacije

39,90



250 mm

118.0050 **Komplet prehodnih škarij za pločevino z ročico**

i  **5**
 Dodatne informacije

**Komplet Wi-Fi videoskopov s \varnothing 5,5 mm
 0° HD sonda sprednje kamere**

**TAKO PAMETEN KOT VAŠ
 PAMETEN TELEFON**



IP68

3500 mm

HD

WiFi

39,90

550.7560

VIDETI SKRITO

i  **5**
Dodatne informacije

HD

6 Mini LED svetilke z možnostjo zatemnitve

Ø 6,0 mm

1000 mm

239,90

0 / 90°

Magnet

550.7500 Komplet videoskopa HD z Ø 6,0 mm 0° in 90° HD sondo sprednje kamere, preklopni

ALI

EXTEND YOUR EYE

Priključna sonda

3,5"

USB 2.0

microSD

1500 mAH Li-polymer

Tulec iz legiranega jekla
Vijačni priključek za pribor

Kronska oblika (zaščita + optimalno čiščenje)

Kamera

Leča

LED

Tulec iz legiranega jekla z zunanjim navojem

Safirno steklo

1000 mm

50 mm

IP 67

1280 x 720

JPG

150 mm

-10°/+50°C

ALI

i  **7**
Dodatne informacije

HD

PUSH 0 / 90°

1000 mm

Ø 4,5 mm

6 Mini LED svetilke z možnostjo zatemnitve

299,90

Magnet

Kavelj

550.7530 Komplet videoskopa HD z Ø 4,5 mm 0° in 90° HD sondo sprednje kamere, preklopni



VROČA CENA, PEKLENSKO DOBRA PREDSTAVA > 1.600 NM SAMO 69,90€



3 515.1200 69,90

4 515.1210 149,90

5 515.3785 305,90

6 515.3400 168,90

1 515.1315 69,90

2 515.1270 149,90



		MAX. Nm	U/min	m/s ²	dB(A)	dB(A)	l/min	PT			Kg
1	515.1315	1084	9000	<10,36	106,0	115,0	169	1/4"	—	✓	1,2
2	515.1270	1390	10.000	<9,18	102,0	113,0	135	1/4"	—	✓	1,3
3	515.1200	1600	8500	<17,5	89,9	100,9	169	1/4"	✓	—	2,1
4	515.1210	1690	7930	<17,9	87,0	98,0	178	1/4"	✓	—	2,1
5	515.3785	1690	7930	<13,56	88,0	104,0	178	1/4"	✓	—	2,2
6	515.3400	2000	8500	<17,25	91,0	100,9	196	1/4"	✓	—	2,2

VISOKA ZMOGLJIVOST PO NIZKI CENI!

max. 1.600 Nm

69,90



		MAX. Nm	U/min	m/s ²	dbA	dbA	l/min	PT			Kg	
7	515.3250	3/4"	3450	6200	<12,57	115,5	104,5	283	1/2"	✓	—	6,7
8	515.3260	3/4"	3450	6200	<12,88	115,5	104,5	283	1/2"	✓	✓	7,7
9	515.3270	1"	3450	6200	<12,57	115,5	104,5	283	1/2"	✓	—	6,7
10	515.3280	1"	3450	6200	<12,88	115,5	104,5	283	1/2"	✓	—	7,8

visokozmogljivo dvojno udarno kladivo
Vse cene v EUR brez DDV-jem veljajo do 30.9.2023

Visokozmogljiva udarna naprava Jumbo



i  **1**
 Dodatne informacije

od 24,90

PU ✓

515.3330	6,0 mm	G1/4" AG	8,0 m	24,90 €
515.3335	8,0 mm	G1/4" AG	15,0 m	34,90 €
515.3340	10,0 mm	G3/8" AG	15,0 m	39,90 €

i  **1**
 Dodatne informacije

Pnevmatska izpihovalna pištola z uravnavanjem pretoka

9,90

515.1901

i  **3**
 Dodatne informacije

19,90

TRIJE IZ MESTA IZPIHOVANJA

515.1921 Komplet pnevmatskih izpihovalnih pištol

i  **1**
 Dodatne informacije

119,90 15 m

179,90

Ø 10 MM X 15 M

Ø 13 MM X 15 M

515.3440 Samodejni navijalnik pnevmatske cevi 515.3445

i 1
Dodatne informacije



480 mm
320 mm
36 mm

11,90

500.8040



i 1
Dodatne informacije



1.150 mm
550 mm
36 mm

39,90

500.8045



i 1
Dodatne informacije



360 mm
365 mm
360 mm

1

49,90

500.8020

i 1
Dodatne informacije



400 - 540 mm

2

67,90

500.8030

i 1
Dodatne informacije



490 mm
1.040 mm
85 mm

3

69,90

500.8011



i 1
Dodatne informacije



420 mm
1.200 mm
145 mm

4

99,90

500.8000



	1	2	3	4	5
Tehnični podatki:	500.8020	500.8030	500.8011	500.8090	500.8000
Barva	rdeča	rdeča	rdeča	rdeča	rdeča
Material	Jeklena cev	Kovina	Kovina	Umetna masa	Kovina
Število krmilnih ročic	4	5	6	6	6
navijalno	✓	✓	✓	✓	✓
Vrsta pnevmatike	Umetna masa	Umetna masa	Umetna masa	Umetna masa	Umetna masa
oblazinjeno	✓	✓	✓	✗	✓
Možnost nastavitve višine	✗	✓	✓	✗	✓
Vsebina embalaže	1	1	1	1	1
Skupna dolžina L v mm	365,0 mm	370,0 mm	1040,0 mm	1030,0 mm	1200,0 mm
Širina B	360,0 mm	370,0 mm	490,0 mm	480,0 mm	420,0 mm
Višina H	360,0 mm	420,0 - 540,0 mm	85,0 - 400,0 mm	115,0 mm	145,0 - 510,0 mm
Skupna nosilnost kg	90 kg	90 kg	90 kg	120 kg	90 kg

i 1
Dodatne informacije

NAJLAŽJA



1.030 mm
480 mm
115 mm

5

67,90

500.8090





Dodatne informacije

- s profilom rebraste pločevine na stopnici
- brez prevrtnice zaradi poševno nastavljenih nog
- zložljivo in s tem prihrani mesto pri pospravljanju

54,90



Aluminijasta dvokraka lestev s stopnicami

800.0965



TESTIRAN ZA VAŠO VARNOST!



Dodatne informacije

- z ndrsečim profilom na tekalnem odru
- z veliko platformo za varno stojišče
- plastični robovi na dnu ščitijo tekalni oder in tla

99,90



800.0960

Varnostni aluminijasti prečni oder



Dodatne informacije

MAJHEN IN HKRATI VELIK!



179,90

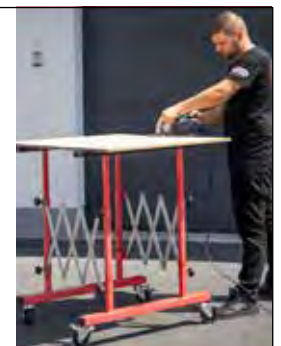

500.8100

Univerzalni teleskopski večnamenski voziček s kolesčki

i **1**

Dodatne informacije

max. 8 bar
(116 PSI)

60° C
140° F

1

2

Water
Max. 40° C

Detergent
Max.

3

4

5

Switch

Lock

150.8271

Razpršilnik pene s tlačno črpalko (penilnik)

i **1**

Dodatne informacije

84,90

350 mm

650 mm

- robustni in prečni stol
- pralna obloga blazine
- štiri kroglično ulezajene krmilne ročice iz polivinil klorida
- največ obremenljivo do 95 kg
- stabilna jeklena štiriobna cevna konstrukcija
- z ravno za shranjevanje za odlaganje orodij in majhnih delov

500.8013

Prenosni stolček

Ø 90 mm

15 mm

M8

5,90

515.1243 Radirka za folije

24 mm

Ø 100 mm

M8

15,90

515.1247 Radirka za folije z lamelami

KOMPLET = 6x

29,90

515.1285

KOMPLET = 6x

89,90

515.1366

141,90

515.1980 Pnevmatška čistilna pištola

ON - OFF

360°

30°

1/4" NPT	8000	160 Litre
6,3 bar (Popul)	3/8"-10 mm	<3,90 m/s
106 dBA	95 dBA	1000 ml

OPCIJSKO

5,90

515.1983 Nastavek za krtačo

5,90

515.1986 Krtača-čopič

i  **1**
Dodatne informacije

6,3 Bar 96 Litrov
 92 dBA 1/4" BT

- za odsesavanje umazanije v vrečo za prah in izpihovanje površin

145 mm 3/8" - Ø 10 mm

39,90

www.kstools.com 515.5090

515.5090 Pnevmatska sesalno-izpihovalna pištola

i  **6**
Dodatne informacije

510 mm

4 mm 8 mm 10 mm

4 mm 8 mm 10 mm

245 mm

Komplet orodij za sprostitvev sponk

29,90

140.2370



i  **11**
Dodatne informacije

19,90

160 mm 180 mm 200 mm 200 mm 200 mm 200 mm 210 mm

911.8205 MASTER komplet plastičnih klinov



i  **1**
Dodatne informacije

DC 12V 24V AC 100-240V 50/60 Hz

- odstrani vonjave in razkuži notranjost vozila
- samodejni izklop v načinu odpravljanja vonjav po 60 minutah
- deluje brez kemičnih dodatkov, zato je zagotovljeno čiščenje brez ostankov
- celo na občutljivih površinah ne pušči sledi
- odstranjuje plesen, bakterije, glivice in pršice

173 mm 49 mm 122 mm

79,90

550.1183 Plazma naprava za čiščenje zraka s tehniko ionizatorja



i  **7**
 Dodatne informacije



79,90

115.1055 **Komplet klešč za cevno objemko za motorno vozilo**



i  **3**
 Dodatne informacije

9,90



115.5050



i  **3**
 Dodatne informacije



115.5055

12,90



i  **1**
 Dodatne informacije



14,90

Sesalne in ročne polnilne črpalke, 0,2 litra

150.9221 



i  **1**
 Dodatne informacije

19,90



100 mm

3/8" poseben natični ključ za privitja sesalne cevi

150.2519 



i  **1**
 Dodatne informacije

19,90



12,0 V

12V 5A 60W
 Richting Direction
 150.2820

Električna oljna sesalna in pretočna črpalka

150.2820





Dodatne informacije



0 - 2,5 bar



max. 76 cm

0 - 200 °C
0 - 400 °F

1600 mm



R123
R124

R123
R125

#1

#2

#3

M50 x 2,5

M42 x 3



M58 x 3

M62 x 3

M48 x 4

M45 x 3

M50 x 2,5

M60 x 4

M52 x 3



M48 x 2,5

M42 x 2,5

M50 x 3

M46 x 3

M34 x 2,5

75 mm



179,90

MASTER
diagnostični servisni komplet hladilnega sistema

150.1930



Dodatne informacije



250 ml



OPCIONALNO

14,90

150.1914

99,90

150.1910

Komplet za preverjanje tesnjenja CO2 na glavi motorja

ZA MOTORJE VAG IN OPEL

i  **1**
Dodatne informacije

19,90



500.7505 Snemalnik vžigalnih tuljav za palične vžigalne tuljave



i  **7**
Dodatne informacije

69,90



500.7570 Komplet snemalnikov vžigalne tuljave s T-ročajem za VAG in Opel motorje



i  **7**
Dodatne informacije

120 ml 120 ml



6x10
6x6
6x8
6x4
600 mm
Ø 6x9 mm

169,90

150.1900 Komplet tlačnih in podtlačnih črpalk



i  **24**
Dodatne informacije



49,90

700.1280 Komplet orodja za montažo tesnilnega obroča gredi in obroča Simmer



i  **1**
Dodatne informacije



max. 165 mm

39,90



Univerzalen snemalnik jermenice z utori
Ø 40-165mm

150.3170



i  **1**
Dodatne informacije

Področja uporabe:
 Citroën, Peugeot, Opel in Toyota z 1,0 in 1,2 bencinskimi motorji
 (koda motorja: ZMZ (EBOF/EBO)/HMO1 (1PP)/HMV, HMZ (EB2)/
 HMZ (EB2/EB2F)/HMT (EB2D)/HMU (EB2D)/HNZ (EB2DT)/HNY
 (EB2DTS)/HMV (EB2M)/HMY (EB2M)/B12XE (EB2F)/D12XE
 (EB2FA)/B12XHL (EB2DT)/D12XHL, F12XHL (EB2ADT)/B12XHT
 (EB2DTS)/D12XHT, F12XHT (EB2ADTS)

9,90



400.2118 **Orodje za preverjanje zobatega jermena za PSA**

i  **1**
Dodatne informacije



M 15 x 1,5 x 71 mm



27 mm

70 mm

34,90

150.3130 **Univerzalen snemalnik za jermenico, 3 snemalne ročice**

i  **22**
Dodatne informacije

49,90



- za montažo in demontažo težko odpirajočih spojk napeljav z vzmetnim zapiralom CLIC pri napeljavah za gorivo, klimatskih naprav, napeljavah za zrak in hidravličnih napeljavah
- brez poškodb vtičnih spojk, napeljav za gorivo in gibkih cevi za gorivo
- hitro in preprosto ločevanje napeljav za gorivo
- za skorajda vse spojke napeljav za evropska, azijska in ameriška vozila





5/16" 1/4" 5/16" 3/8" 3/8" 1/2" 5/8" 7/8"

3/8" 1/2" 5/8" 3/4" 5/16"

3/8" 1/2" 5/8"

3/4" 7/8" 5/16" x 3/8"

5/16"

115.1260 **Komplet za sprostitvev spojk cevi**

i  **1**
 Dodatne informacije

• TESLA model 3 in model S

5,90

EPR10

1/4"

911.4363  **1/4"** Poseben profilni natični nastavek za Tesla



i  **1**
 Dodatne informacije

4,90

6-24V 125 mm

550.1504 Kontrolna luč 6-24 V



i  **2**
 Dodatne informacije

- idealna kontrolna svetilka s funkcijami za preverjanje
- z vgrajeno osvetlitvijo za optimalno osvetlitev preskusnega mesta
- z zamenljivo kontrolno konico do opsijske razširitve s tržno običajnimi kontrolnimi in testnimi komponentami
- hitro preverjanje delovanja brez demontaže komponent
- vgrajena dvojno kovinska varovalka pred kratkim stikom (7,5 A), zato pri iskanju napak ni obrabe varovalke

25 m

129,90

Funkcijska kontrolna luč 6-24V DC s 25-metrskim kablom

150.1655



i  **2**
 Dodatne informacije

1 Prejemnik

2 Oddajnik s krokodilskimi sponkami

59,90

150.3075 Detektor kratkega stika

- za hitro, preprosto in strokovno iskanje kratkih stikov, napak na kablu in plazilnega toka, ne da bi bilo treba prebošiti napeljave
- velik prihranek časa, ker je mogoče odstranjevanje prevlek, prepreg in letev na vozilu zmanjšati na najnujnejše
- za testiranje in zaznavanje občasno prekinjenih povezav ("slabi kontakti")
- oddajnik se bo povezal z električnim tokokrogom, ki ga je treba testirati, z izoliranimi krokodilskimi sponkami prek škatle z varovalkami







Dodatne informacije



Za skoraj vse
akumulatorje

S tiskalnikom in
trema rolami papirja



NATANČNO PREVERI AKUMULATOR

12V / 24V digitalni tester baterij
in polnilnega sistema z vgrajenim
tiskalnikom

550.1649



367,90

Tehnični podatki:

Prikaz:	digitalno
Delovno območje CA / MCA:	40-2.000 CCA
Delovno območje CCA:	40-2.000 CCA
Delovno območje DIN:	40-2.000 CCA
Delovno območje EN:	40-2.000 CCA
Delovno območje IEC:	40-2.000 CCA
Delovno območje JIS#:	40-2.000 CCA
Delovno območje SAE:	40-2.000 CCA
Delovna temperatura:	0°C do +55°C
Frekvenčno območje:	100 Hz
Merilno območje:	9-36 V
Natančnost merjenja:	+/- 0,5 Megaohm
Napajalno območje:	9-36 V



Dodatne informacije



- idealno za bencinske in dizelske motorje v osebnih vozilih vse do transporterjev
- polno izolirane sponke akumulatorja (1000A)
- zvočni opozorilni signal pri zamenjavi polaritete
- neelektrični kabelski priključek na akumulator vozila
- na udarce odporno ohišje z gumiranim mestom postavitve

611,90

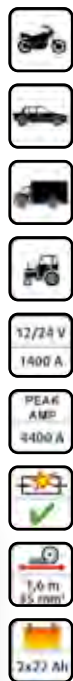

12 V + 24 V ojačevalnik baterije, prenosna naprava
za pomoč ob zagonu 1400 A

550.1720

SAFETY Xtreme

i  **26**
Dodatne informacije

DE GS
1000 V

329,90

3/8"

Komplet orodij z izoliranimi orodji za hibridna in električna vozila

117.1895

2 x		4 mm - 5,5 mm
2 x		PH1 - PH2
6 x		6 - 8 - 10 - 12 - 13 - 17 mm
1 x		185 mm
1 x		165 mm
1 x		3/8"
1 x		3/8": 200 mm
1 x		3/8": 125 mm
10 x		3/8": 8 - 10 - 11 - 12 - 13 - 14 - 16 - 17 - 19 - 22 mm
1 x		200 mm

i  **43**
Dodatne informacije













DE GS
1000 V

564,90

3/8"

Komplet orodij z izoliranimi orodji za hibridna in električna vozila

117.1890

4 x		2,5 - 3 - 3,5 - 4 mm
3 x		PH1 - PH2 - PH3
3 x		T20 - T25 - T30
1 x		210 mm
1 x		185 mm
1 x		165 mm
1 x		215 mm
1 x		165 mm
1 x		240 mm
2 x		10 - 25 mm
1 x		180 mm
1 x		3/8"
15 x		3/8": 6 - 7 - 8 - 9 - 10 - 11 - 12 - 13 - 14 - 16 - 17 - 18 - 19 - 20 - 22 mm
2 x		3/8": 150 - 250 mm
3 x		3/8": M8 - M10 - M12
1 x		Ø 200 mm
1 x		200 mm
1 x		500 m

i  **18**
Dodatne informacije

DE GS
1000 V

329,90

Komplet viličastih ključev z zaščitno izolacijo

118.1500

18 x		7 - 8 - 9 - 10 - 11 - 12 - 13 - 14 - 15 - 16 - 17 - 18 - 19 - 20 - 21 - 22 - 23 - 24 mm
------	---	---

i  **1**
Dodatne informacije

<44.500 V

179,90

Izolirana reševalna palica

150.0913

1.680 mm

Wključeno s stenskim držalom

Vse cene v EUR brez DDV-jem veljajo do 30.9.2023

KOMPLET ZA ZAČETNIKE V ELEKTRIČNI MOBILNOSTI

ecoline



⊖ 2,5 - 4 - 5,5 mm ⊕ PH0 - PH1 - PH2



2

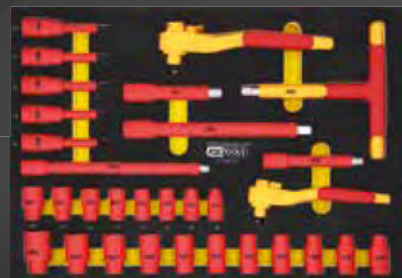

3/8" 8-18 mm 1/2" 10-24 mm 125+250 mm
125+250 mm 4-5-6-8-10 mm
3/8"+1/2"

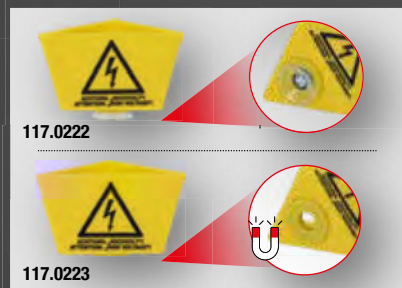

117.0222

117.0223



Štiriobna odprtina za dele pribora

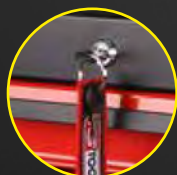

mogoče zakleniti z vgrajeno cilindrično ključavnico



delovna plošča z 10 mm debelim penastim vložkom



s samodejnim uvlekom in funkcijo SOFT-CLOSE

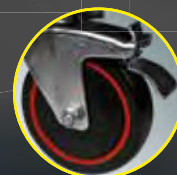

2 x kotalna in vrtljiva zavora Ø koles: 125 mm

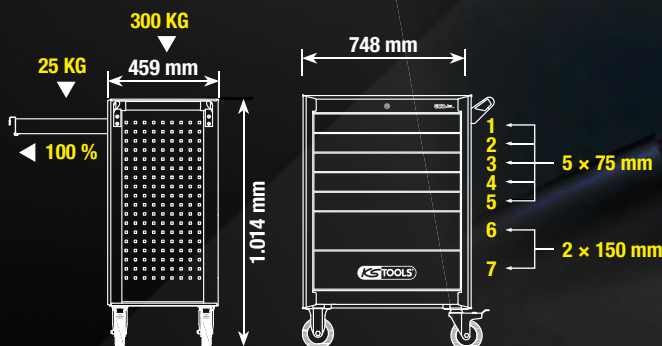

ECOline delavniški voziček s 42 z izoliranimi orodji za hibridna in električna vozila

117.6144

1299,00
vključno z 42 orodji



4299,00



+



117.6172 3/8" + +1/2" komplet izoliranih natičnih klujučev močnejše izvedbe z momentnim klujučem v penastem vstavku, 72-delni



117.6133 Komplet izoliranih klujučev v penastem vstavku, 33-delni

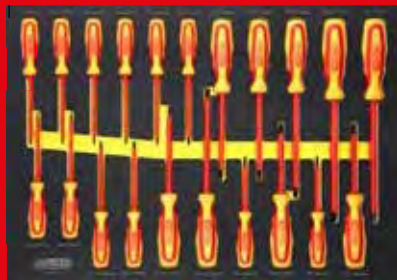

117.6121 ERGOTORQUE VDE komplet izvijačev v penastem vstavku, 21-delni



117.6117 ERGOTORQUE VDE komplet klešč v penastem vstavku, 17-delni



117.6155 PERFORMANCEplus delavniški voziček e10 s 164 z izoliranimi orodji za hibridna in električna vozila

NAJOBSEŽNEJŠI V SVOJEM RAZREDU!

9,90



117.0223 Krovno stojalo s simbolom strele in magnetom



9,90

117.0222

Krovno stojalo s simbolom strele in priseskom



14,90

117.0226

Stojalo s simbolom strele

69,90

117.1550

Komplet zapornih drogov z verigo

2x

139,90

117.1545

2 x Strižna blokada iz umetne mase



Katalog o električni mobilnosti s 188 stranmi najdete na spletnem mestu: www.kstools.com

i  **4**
Dodatne informacije

Ø 22,0 - 28,0 mm

Ø 15,0 - 21,0 mm

Ø 17,0 - 25,0 mm

Komplet centrirnih orodij za sklopko

8,90

150.2180 Ø 15,0 - 28,0 mm



i  **11**
Dodatne informacije

150 kg

310 mm

450 mm

300 mm

394,90

160.0910 **Komplet univerzalnih nosilcev gonila**



i  **3**
Dodatne informacije

- 1 Montaža in demontaža polnilega orodja A
- 2 Izpust olja, majhen pretok
- 3 Preverjanje nivoja napolnjenosti
- 4 Izpust olja, poln pretok

24,90

9G-TRONIC

56 mm

74,5 mm

20 mm

28,5 mm

9 mm

39,5 mm

9 mm

152 mm

48 mm

150.9695



160.0910 **Komplet univerzalnih nosilcev gonila**



i  **24**
Dodatne informacije

NAJOBSEŽNEJŠI!

199,90

vkjučno s 23-delnim adapterskim kompletom

NOVO!

150.9261 1/8-27 NPT Ford

150.9262 BMW, Honda, Nissan etc.

150.9263 VAG

150.9264 VAG, Porsche

150.9265 M10 x 1.0 VAG, Mini Cooper

150.9267 M12 x 1.5 Mercedes

150.9268 M24 x 1.5 VAG DSG

150.9269 M22 x 1.5 VAG CVT

150.9271 M18 x 1.5 Skoda

150.9272 M30 x 1.5 VAG, Skoda

150.9273 Universal Flexible 300 mm, Honda, Hyundai, Kia, etc.

150.9274 5/16-24 (UNF) Volvo

150.9276 M18 x 1,5 Toyota / Lexus

150.9277 M8 x 1,0 Nissan / Infinity

150.9278 ATF-Adapter V.W, Passat

150.9562 Nissan Juke M12 x 1,25

150.9563 Mini Cooper M14 x 1,5

150.9564 Nissan M10 x 1,5

150.9566 GM M12 x 1,75

150.9567 Mercedes 725-9G

150.9102 VAG 7 DSG

150.9103 VAG 7 DSG

150.9104 VAG 7 DSG

150.9105 **Komplet univerzalnega polnilega sistema za menjalnik olja s 23-delnim kompletom adapterjev**



i  **4**
Dodatne informacije



111,90

160.0195 McPherson opornik za vzmetno nogo za dvigalko gonila

i  **7**
Dodatne informacije



99,90

150.9545 Komplet posebnih pripomočkov za montažo odbijača z dostopnimi udarnimi vzmetmi

i  **6**
Dodatne informacije

ZA SKORAJ VSE VZMETI!



Ø 80 - 160 mm

OBREMNENA maks. 26000 N

Ø 140 - 195 mm

451,90

500.8400 Komplet univerzalnih napenjalnikov vzmeti

- idealno primeren za varno montažo in demontažo vijajčnih vzmeti
- potreben pri menjavi blažilnikov ali vijajčnih vzmeti
- univerzalen za 90% vseh običajnih vzmeti za vozila pri osebnih vozilih in območju transporterjev
- stroškovno ugodna in solidna alternativa za običajne vzmetne napenjalnike
- primeren tudi za konične in krogljčne vzmeti
- z dovoljenjem TÜV

Tehnični podatki:

Kapaciteta vzmeti:	2600 kg
Napenjalna širina maks.:	355,0
Tlak vzmeti maks.:	80,0 - 195,0 mm



TESTIRAN ZA VAŠO VARNOST!

i **11**
Dodatne informacije

TUV SUD

1/2" x 1/2", 100 Nm

Ø 30 mm

Ø 90 - 140 mm

372,90

500.8765 Audi in Seat komplet teleskopskih napejalnikov za notranje vzmeti

ZA RAZŠIRITEV

i **2**
Dodatne informacije

Ø 95-110 mm

99,90

v povezavi z napejalnikom vzmeti
500.8755 + 500.8765

NOVO

• Področja uporabe:
MercedesE-razred (W211 / W212), C-razred (W204), GLA (X156), GLK (X204), Ford Focus II (MK2), BMW serije 1 (E81), Volkswagen Passat (B8/3G)

500.8770 Par vzmetnih nosilcev Ø 95-110mm

ZA RAZŠIRITEV

i **9**
Dodatne informacije

TUV SUD

Ø 30 mm

Ø 90 - 140 mm

Ø 75 - 115 mm

338,90

500.8755 komplet univerzalnih teleskopskih napejalnikov za notranje vzmeti

WARNING - ACHTUNG - ADVARSEL
ADVERTENCIA - AVERTISSEMENT

ZA 95 % VSEH VOZIL



Dodatne informacije

max
12000
N



1149,00

Pnevmatski pokončni napenjalnik
vzeti, maks. 10 bar

500.8800

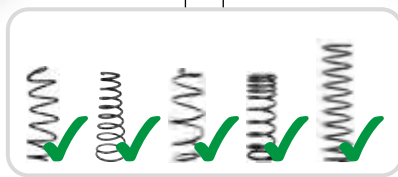

Dodatne informacije

max
24000
N

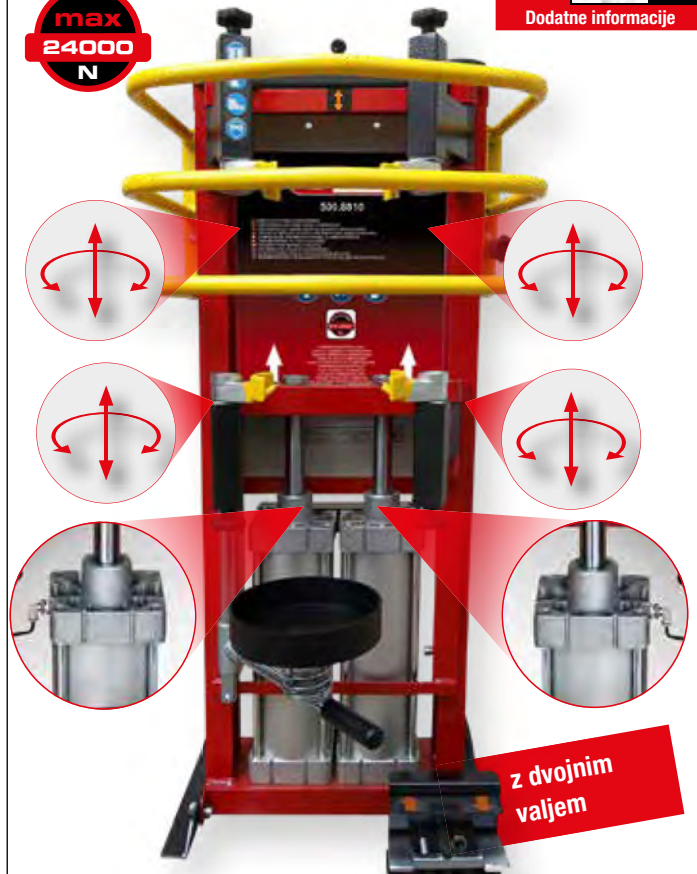

1599,00

Pnevmatski napenjalnik vzmeti z
dvojnimi valjema

500.8810



Dodatne informacije

- preprosta uporaba
- posebno orodno jeklo
- idealen za pritrditev vzmetnih nog
- optimalno za varno stojišče pri montaži in demontaži
- s 4 fiksirnimi sorniki in 4 navojnimi sorniki
- dobava z 2 vzmetnim podložkama za montažo



281,90

Adapterska plošča za pnevmatski pokončni
napenjalnik vzmeti

500.8801

KOMPLET NAPENJALNIKOV VZMETI, VKLJUČNO Z ADAPTERSKO PLOŠČO



Dodatne informacije

1349,00

Pnevmatski pokončni napenjalnik
vzeti, vključno z adaptersko ploščo

500.8805



Dodatne informacije

1799,00

Pnevmatski napenjalnik vzmeti z dvojnimi valjema,
vključno z adaptersko ploščo

500.8815



i   1
Dodatne informacije

max. 8,0 bar

1/4" PT

450 mm

99,90

za univerzalne osne manšete

515.3100 Montažna naprava na stisnjen zrak za osne manšete



i   1
Dodatne informacije

100 mm

255 mm

Ø 30 mm

49,90

150.1850 Univerzalen snemalnik dvočlenkastih gredi



i   1
Dodatne informacije

VA FE

0 - 45 mm

270 mm

39,90

Klešče za gibke cevi za priteg obratovalnega zateznega momenta

115.1056



i   1
Dodatne informacije

max. 12 mm

49,90

Vpenjalne klešče za kabelske vezice iz nerjavečega jekla s krogelnim zapiralom

115.1590

+ od 25,90

Vezica za kable iz nerjavečega jekla s krogelnim zapiralom

200 - 350 mm

115.1591		 100	4,6 × 200 mm	25,90 €
115.1592		 100	4,6 × 250 mm	25,90 €
115.1593		 100	4,6 × 350 mm	28,90 €
115.1594		 100	4,6 × 500 mm	37,90 €



i  **1**
 Dodatne informacije

UNIVERSAL

10 mm

39,90

700.5662 Orodje za širjenje vpenjalne izvrtine



i  **1**
 Dodatne informacije

24,90

Poseben natični nastavek za nosilni zgib za Mercedes

150.1721   Mercedes W167, W205, W213, W238, W253, W25



i  **6**
 Dodatne informacije

369,90

515.3880 Komplet pnevmatskih sekačev Vibro-Impact

VIBRO-POWER
 515.3881
 152880316

110 mm
 110 mm
 130 mm
 100 x 25 x 12 mm

31x / 1 sec.

VIPRO





i  **3**
 Dodatne informacije

31,90

700.5635 Komplet izbijal pritrdilnih vijakov



i  **1**
 Dodatne informacije

205,90

150.1608 Orodje za sprostitve Vibro-Impact za krmilne drogov

- odvijanje krmilnih drogov s pomočjo treslajev, protiprivitij ali privitij v območju osi itd.
- zaradi posebnega vibracijskega trna se na vijačni priključek, ki ga je treba zrahljati, sproži udarni impulz, rja se sprosti in podpre postopek rahljanja
- adapter za pnevmatsko dleto (10 mm) za uporabo z običajnimi pnevmatskimi udarnimi kladivi z dletom

27 mm

290 mm

65 mm





i **1**
Dodatne informacije

600 - 915 mm

89,90

911.8187 Teleskopska vzvodna jeklena ročica z zgibno kotalno glavo

i **1**
Dodatne informacije

M 30

360°

1.360 - 2.030 mm

Teleskopski podstavni podpornik

121,90

160.0342

i **1**
Dodatne informacije

400 mm

400 mm

99,90

700.1465 Orodje za preverjanje zračnosti osi

i **1**
Dodatne informacije

960 mm

168,90

700.1495 Univerzalni osni vzvod z verigo

i **6**
Dodatne informacije

VROČA NAPRAVA

160 mm

Ø 50 mm

170 mm

Ø 40 mm

160 mm

Ø 30 mm

750 mm

120 mm

Ø 56 mm

1000 W

451,90

500.8480 Komplet indukcijskih grelnih pištol



i **22**
Dodatne informacije



Ø / mm

42	40	38	36	34	#1
32	30	28	26	24	#2
					#3
					#4

M12
M10
M12 M10 TR20

735,⁹⁰

700.2355 Komplet stopenjskih tlačnih tulcev



i **37**
Dodatne informacije



1 x
2 x
9 x
13 x

Ø1: 34 - 80 mm Ø2: 44 - 90 mm

Ø 38 - 40 - 42 - 50 - 52 - 54 - 62 - 64 - 66 mm
 Ø 34 - 36 - 44 - 46 - 48 - 56 - 58 - 60 - 68 - 70 - 72 - 75 - 80 mm

M10x1,5
M12x2,0
M14x2,0
M16x2,5

299,⁹⁰

700.1550 Komplet tlačnih in poteznih tulcev



i **4**
Dodatne informacije



30-35 mm 35-40 mm 40-45 mm

360 mm

Komplet posebnih ključev za aksialni zglob

79,⁹⁰

1/2" / 32 mm

150.1125

i **30**
Dodatne informacije



1 x
1 x
4 x
4 x
4 x
1 x

Ø 90 - 130 mm

M14

M12 x 1,25
M12 x 1,5

M12 x 1,25
M12 x 1,5
M14 x 1,5

M18 x 2,5 x 230 mm M57 x 2

4,3 Kg

224,⁹⁰

700.1530 Komplet univerzalnih snemalnikov pesta kolesa in dvočlenkastih gredi

i  **1**
 Dodatne informacije

14,90

Ø 20 mm

150 mm

150.2199 **Tester zavorne tekočine**



i  **1**
 Dodatne informacije

VITON®
FKM

27,90

150.8258 **Črpalna razpršilna steklenica za čistilo zavor**

Posebej za čistilo zavor



i  **2**
 Dodatne informacije

10,90

150.1935 **Komplet univerzalnih jezičkov, z možnostjo oblikovanja**



i  **2**
 Dodatne informacije

14,90

150.2235 **Komplet univerzalnih adapterjev, tog**



i  **12**
 Dodatne informacije

67,90

1/2" 11,5 mm 14 mm 15 mm 20 mm AS 22 mm

1/4" 9 x 20 mm

3/8" 7 x 72 mm
 7 x 92 mm
 9 x 50 mm
 11 x 100 mm

3/8" 7 x 25 - 8 x 25 mm

Komplet posebnih natičnih nastavkov za zavorno sedlo

150.2400 1/4" 3/8" 1/2"



i  **41**
 Dodatne informacije

99,90

150.1970 **Komplet orodij za ponastavitev zavornih batov**





Dodatne informacije

UNIVERZALEN GENIJ

UNIVERSAL
Za 95 % vseh vozil

2 zatiča
3 zatiči
NOVO
4 zatiči
3/8"

129,90

150.2440 Komplet univerzalnih orodij za ponastavitev zavornih batov

699,90

5L

160.0700 Naprava za vzdrževanje zavor

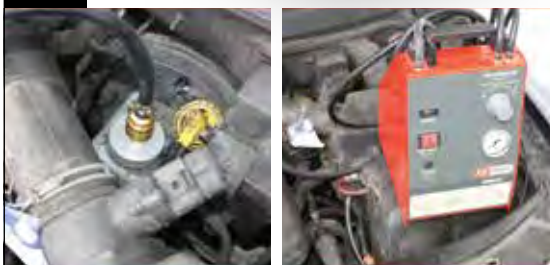

59,90

UNIVERZALNO NASTAVLJIVI

360°
min. 18 mm
Max. 70 mm
Min. 28 mm

160.0718 Univerzalen adapter za odzračevalni nastavek, nastavljiv



i  **6**
 Dodatne informacije

STOP

1.200 mm

69,90

11 mm
 10 mm
 9 mm
 8 mm
 7 mm

160.0725 Komplet ključev za odzračevanje zavor

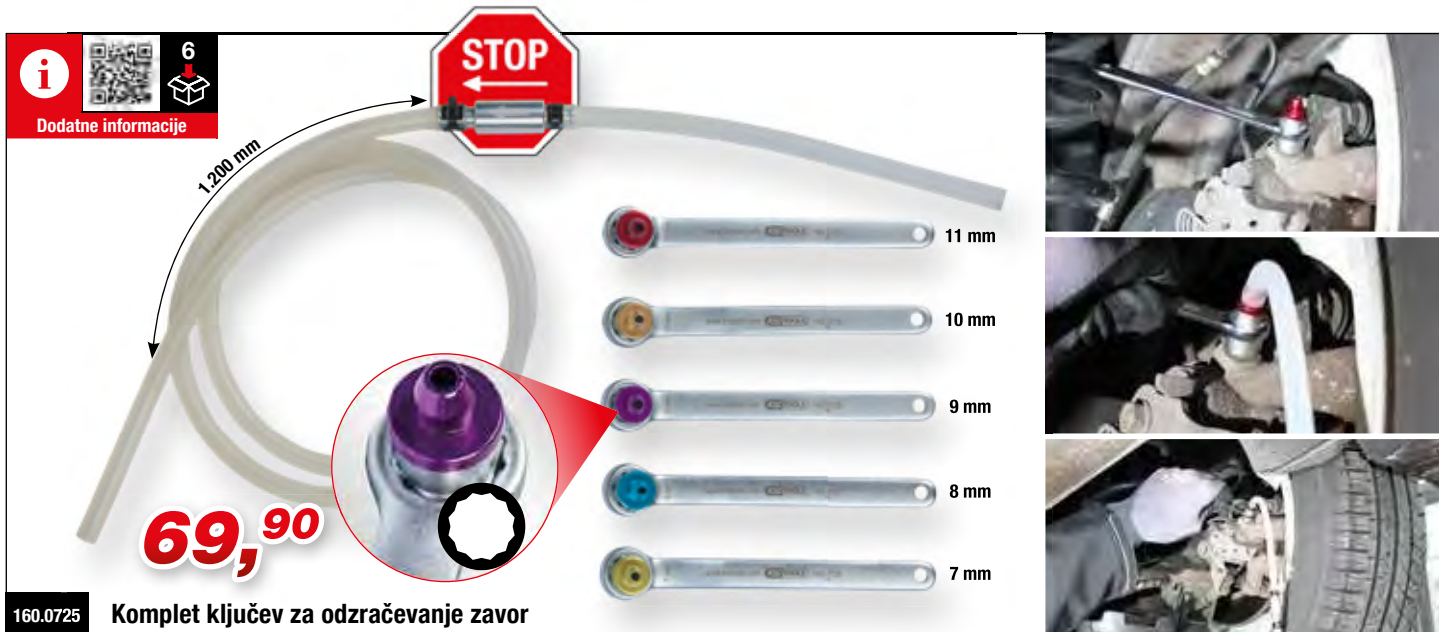

i  **1**
 Dodatne informacije

4,75 mm (3/16")

21 mm
 31 mm
 41 mm
 61 mm
 76 mm

39,90

120.1006 Orodje za upogibanje zavornega voda



i  **1**
 Dodatne informacije

4,75 mm (3/16")
 6,35 mm (1/4")

29,90

120.1004 Orodje za nastavljanje/upogibanje zavornega voda

1 Upogibanje
2 Podvojitvev
3 Poravnava

OUT IN



i  **4**
 Dodatne informacije

49,90

122.1215 FLAREFIXeco 4,75 mm komplet univerzalnih naprav za robljenje zavornega voda





Dodatne informacije

FLAREFIX



169,⁹⁰

DIN
SAE



3,0-40,0 mm

3,0-6,0 mm

3,0-16,0 mm

4,75-5,0 mm, OP1, SAE

4,75 mm, 3/16"

6,0 mm, OP1, SAE

4,75-5,0-6,0 mm, OP2

4,75-5,0 mm

5,0 mm

6,0 mm

6,0 mm

122.1290

FLAREFIX 1 univerzalen komplet z napravo za robljenje zavornih vodov s hidravličnimi vreteni



Dodatne informacije

FLAREFIX II

Hydraulic

299,⁹⁰

DIN
SAE



max.
2,5t



M12 x 1,25 mm

4,75-5,0 mm, OP1, SAE

6,0 mm, OP1, SAE

4,75-5,0-6,0 mm, OP2

4,75-5,0 mm

6,0 mm

M12x1,25

4,75 mm, 3/16"

5,0 mm

6,0 mm



122.1260

FLAREFIX 2 komplet univerzalnih naprav za robljenje zavornih vodov s hidravličnimi valji



Dodatne informacije



24,⁹⁰

3/8" komplet posebnih profilov za menjavo olja za plastične vijake za izpust olja

150.1040



Dodatne informacije



Ø 385 mm

12,⁹⁰

150.9359 Prestrezna posoda 7,5 l



Dodatne informacije

ZA VAG



- idealen za čisto, strokovno in okolju prijazno polnjenje
- neposredna in tesna povezava z odprtino za polnjenje olja
- preprečitev izgube in umazanije zaradi iztekajočega olja na blok motorja ali izpušni zbiralnik
- z vrtljivo kotno ročico za težko dostopna mesta

• z vrtljivo kotno ročico za težko dostopna mesta



14,⁹⁰

150.9155 Komplet lijakov za polnjenje olja z vrtljivim kotnim nosilcem



Dodatne informacije

UNIVERZALNI



Ø 63 - 102 mm

99,90

3/8"



65-14, 65/67-14, 66-6, 68-14, 73-14, 74-15, 74/76-15, 75/77-15, 76-8, 76-12, 76-14, 76-30, 78-15, 80-15, 80/82-15, 86-18, 86-16, 90-15, 92-10, 93-15, 93-36, 93-45, 95-15, 96-18, 100-15, 106-15, 108-15, 108-18

150.9350 3/8" Komplet ključev za oljni filter



Dodatne informacije

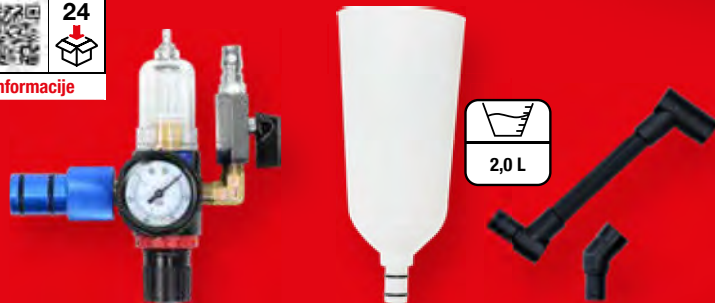

2,0 L

99,90



- vključno z bajonetnim adapterjem in adapterjem za platformo VAG-MQB
- neposredna in tesna povezava z odprtino za polnjenje olja
- z vrtljivo kotno ročico za težko dostopna mesta
- idealen za čisto, strokovno in okolju prijazno polnjenje
- preprečitev izgube in umazanije zaradi iztekajočega olja na blok motorja ali izpušni zbiralnik

150.9130 MASTER Komplet lijakov za polnjenje olja z vrtljivim kotnim nosilcem





Dodatne informacije

- idealna podlaga za zaščito pragov in laka
- optimalna varnost pred zdrsom
- univerzalna podlaga za dvizne odre
- optimalna za kleparske delavnice, dvizne odre za vulkanizerje itd.
- zelo robustna in tako vsestransko uporabna

39,90

Komplet univerzalnih gumijastih podlog za delavniško dvigalo

160.0391-TD

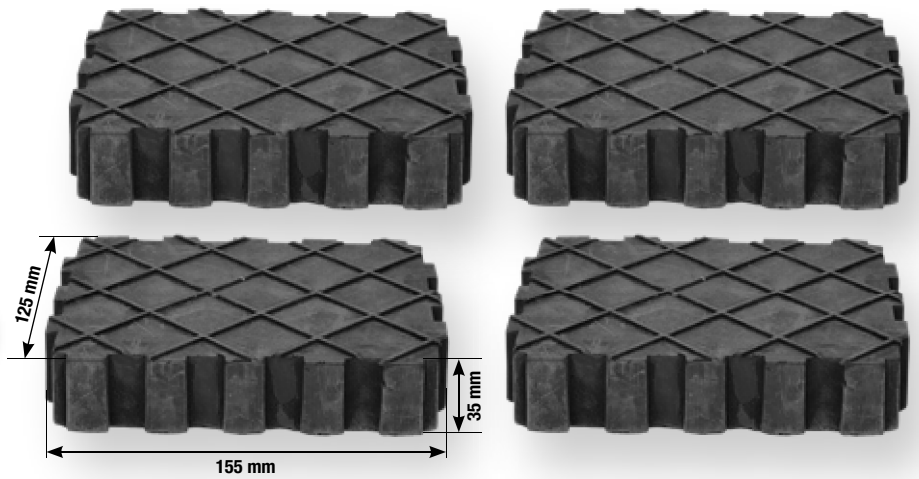

Dodatne informacije



7,90

800.0156 Magnetna skodelica iz umetne mase, Ø 150 mm



Dodatne informacije



9,90

150.2032 Kovinski vzvod za ventil pnevmatike, 330 mm



Dodatne informacije



49,90

800.0190 Kovinski magnetni nosilec, 390 mm



Dodatne informacije



27,90

911.8135 Vzvod za runflat pnevmatiko in montažni vzvod



i  **1**
Dodatne informacije



600 mm

0 - 12 bar

19,90

1/4" PT

515.1950 Merilnik tlaka v pnevmatikah, 0 - 12 bar

i  **1**
Dodatne informacije



400 mm

0 - 10 bar

61,90

umerjeno

1/4" PT

515.1960 Umerjen pnevmatski merilnik napoljenosti pnevmatik, 0 - 10 bar

i  **5**
Dodatne informacije



56,90

OPCIONALNO
60 kosov
17,90
150.1072

150.1070 Komplet za vulkanizacijo pnevmatik za KFZ, vključno s 100 mm niti

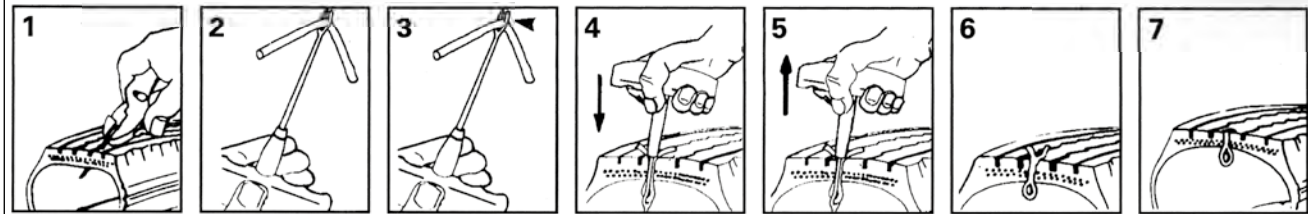

i  **1**
Dodatne informacije



89,90

Komplet aluminijastih brusilnikov za pesto kolesa, Ø 150 mm, notranji Ø 90 mm

OPCIONALNO
34,90
100.5077

100.5080



i  **3**
 Dodatne informacije



1/2" komplet spiralnih profilnih natičnih nastavkov močnejše izvedbe

39,90

913.1270 **1/2"** 17 - 19 - 21 mm



i  **10**
 Dodatne informacije



Komplet za demontažo varovalnih elementov kolesa

8 x 17 mm
 180 mm
 22 mm
 3 x
 18 - 19 - 20 - 21 - 22 - 23 - 24 - 25 mm

59,90

913.1480 **1/2"** 18 - 19 - 20 - 21 - 22 - 23 - 24 - 25 mm



i  **2**
 Dodatne informacije



1/2" komplet natičnih nastavkov močnejše izvedbe za aluminijasta platišča za Ford

27,90

515.0895 **1/2"** 18,5 - 19,5 - 20,5 - 21,5 mm

i  **1**
 Dodatne informacije

ZA MERCEDES

max. 75 Nm

17,90

1/2" torzijski podaljšek močnejše izvedbe, 75Nm

515.1491 **1/2"**



1/2" KOMPLET NATIČNIH NASTAVKOV MOČNEJŠE IZVEDBE ZA ROBUSTNA ALUMINIJASTA PLATIŠČA

1

i **3**

Dodatne informacije

17,90

515.1070 1/2" 17 - 19 - 21 mm

2

i **5**

Dodatne informacije

24,90

515.0870 1/2" 15 - 17 - 19 - 21 - 22 mm

3

i **10**

Dodatne informacije

69,90

1/2" 15 - 17 - 19 - 21 - 22 - 23 - 24 mm

7/8" 17 mm MS21

4

i **17**

Dodatne informacije

139,90

POPOLNO VSESTRANSKI

515.0885 1/2" 15 - 17 - 19 - 21 - 22 - 23 - 24 mm 7/8" 17 mm MS21 17 - 19 - 21 mm 18,5 / 19,5 - 20,5 / 21,5 - 17,5 / 22,5 mm

	515.1072 15 mm	515.1073 17 mm	515.1075 19 mm	515.1076 21 mm	515.1077 22 mm	515.1078 23 mm	515.1079 24 mm	515.1089 Tesla 7/8"	515.2055 Mercedes 17 mm	515.2060 Hyundai KIA MS21	913.1271 Smenalni nastavek spirale 17 mm	913.1272 Smenalni nastavek spirale 19 mm	913.1273 Smenalni nastavek spirale 21 mm	515.0896 Ford 18,5 / 19,5 mm	515.0897 Ford 20,5 / 21,5 mm	515.0899 Ford 17,5 / 22,5 mm	515.1134 Potajisek močnejše izvedbe, 75mm
1	X	✓	✓	✓	X	X	X	X	X	X	X	X	X	X	X	X	X
2	✓	✓	✓	✓	✓	X	X	X	X	X	X	X	X	X	X	X	X
3	✓	✓	✓	✓	✓	✓	✓	✓	✓	✓	X	X	X	X	X	X	X
4	✓	✓	✓	✓	✓	✓	✓	✓	✓	✓	✓	✓	✓	✓	✓	✓	✓



Dodatne informacije

- Natančnost sprožitve $\pm 3\%$ odstopanje od nastavljene vrednosti v lestvici
- ponavljajoče točno in natančno pri najmanj 5.000 uporabi
- za nadzorovano privijanje v desno in levo
- jasno slišna in občutna sprostitvev momenta s sprožitvijo kratke poti
- nastavitev zateznega momenta, hitro in varno z vrtenjem ročaja



123,⁹⁰

20-200 Nm



DAI EN ISO 6789
Potrdilo
Natančnost
10:10

1/2"

500 mm



125 mm

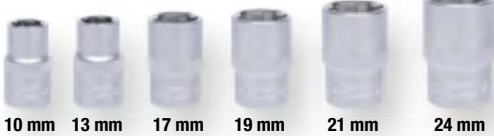

10 mm 13 mm 17 mm 19 mm 21 mm 24 mm



17 mm 19 mm 21 mm



516.2400 1/2" 10 - 13 - 17 - 19 - 21 - 24 mm



1/2" 1600 Nm 2,1 KG

1.600 Nm

Ø 400 mm

Ø 150 mm

515.1205

99,⁹⁰

LIGHT AND SOUND

i  
 Dodatne informacije

19,90



130 Lumnov

300 Lumnov

 s funkcijo zatemnitve

 Funkcija polnilne postaje



USB-A OUT USB-C IN

 IP 65

i  
 Dodatne informacije

260 Lumnov

500 Lumnov

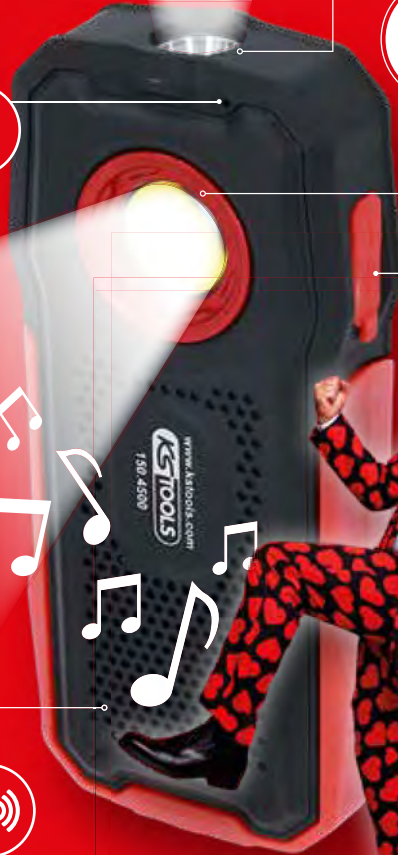

USB-A OUT



49,90







USB-A OUT

USB-C IN

ON OFF

Odvajanje toplote

20 %	
40 %	
60 %	
80 %	
100 %	



vgrajena litij-ionska
 akumulatorska baterija
 1.200 mAh



150.4505



USB-C IN

ON OFF

vgrajena litij-ionska
 akumulatorska baterija
 2.400 mAh



150.4500

Vaš partner



KS Tools Werkzeuge - Maschinen GmbH

Seligenstädter Grund 10 - 12
 D-63150 Heusenstamm

Mail: aftersales@kstools.com
 Web: www.kstools.com

 NEMČIJA

Z izidom tega prospekta postanejo vse predhodne cene neveljavne. Prodaja samo specializiranim trgovinam. Pravice do tiskarskih napak, nesporazumov in tehničnih sprememb pridržane. Vse cene v EUR brez DDV-jem veljajo do 30.9.2023.