



A/C Stations
Air Conditioning Accessories
Disinfection
ATF Automatic Gearbox Service
Radiator Cleaning Units
Engine Decarbonization
Alternator Test Bench
Tyre Lifter
Brake Bleeder
Injector Cleaning Test Bench
Pneumatic Spring Compressor

CATALOGUE

Automotive

EXPERTISE

2021

Price List

1/10/21 - 31/3/22

MADE IN ITALY

PROFESSIONAL GARAGE EQUIPMENT



		BREEZE TOUCH		BREEZE ADVANCE			ASTRABUS ADVANCE	
		DUAL X4	DUAL	EVO	PLUS	BUS	R134a	MULTIGAS
Technical features								
1	Graphic display with icons	TOUCH Display 7"	√	√	√	√	√	√
2	Tank capacity	2 x 10,5 kg	2 x 10,5 kg	22 kg	22 kg	30 kg	40 kg	40 kg
3	Vacuum pump	100 lt/min	100 lt/min	170 lt/min	170 lt/min	170 lt/min	260 lt/min	260 lt/min
4	Heater	BST System	BST System	BST System	BST System	automat.	automat.	automat.
5	Compressor capacity	2 x 400 gr/min	400 gr/min	400 gr/min	400 gr/min	600 gr/min	1000 gr/min	1000 gr/min
6	Automatic recovery	√	√	√	√	√	√	√
7	Automatic oil discharge >95%	√	√	√	√	√	√	√
8	Programmable vacuum	√	√	√	√	√	√	√
9	Programmable vacuum test (in mbar)	√	√	√	√	√	√	√
10	Oil/additive standard injection, with scale	6 injectors	3+1 injectors	3 injectors	3 injectors	3 injectors	2 injectors	2 injectors
11	Injection oil/additive for hybrid vehicles, with scale	√	√	√	√	√	-	-
12	Software for hybrid vehicles	√	√	√	√	√	-	-
13	Automatic gas charge	BST System	BST System	BST System	BST System	√	√ reinforced pump (optional)	
14	Automatic pressure test	√	man Manual ual	√	Manual	Manual	Manual	Manual
15	Guided charge compensation manual WSC	√	-	√	-	-	-	-
16	Automatic Multipass	√	-	√	-	-	-	-
17	Built-in database (cars, industrial vehicles, agricultural machines)	√	√	√	√	√	√	√
18	Personal database	√	100 entries	100 entries	100 entries	100 entries	100 entries	100 entries
19	Automatic selection of charging hoses	4 tubi / 4 hoses	-	√	-	-	-	-
20	Discharge of incondensable gases	Manual/Automat.	Manual	Manual/Automat.	Manual	Manual	Manual	Manual
21	Automatic internal cleaning	√	√	√	√	√	√	√
24	Software for flushing cleaning (with kit 01.000.96 on request)	√	√	√	√	√	√	√
25	Software for recycling cleaning (VW, Audi) (with kit 01.000.139 on request)	√	√	√	√	√	√	√
26	Leakage test with nitrogen (with kit 01.000.326 on request)	√	√	√	√	√	√	√
27	Gas analyzer HF01234YF set up	√	√	√	√	√	-	-
28	Phase and alarm lights	optional	optional	optional	optional	optional	optional	optional
29	Database update via USB	√	√	√	√	√	√	√
30	Scale lock	√	√	√	-	√	-	-
31	CSP: Vehicle compressor protection with LP charge	√	-	√	-	-	-	-
32	Automatic gas recovery from hoses	√	-	√	-	-	-	-
33	Hoses' length adjustment	√	-	√	-	-	-	-
34	Mobile app as a remote control solution	-	-	-	-	-	-	-
35	Ethernet port	-	-	-	-	-	-	-
36	Set up for the 4.0 protocol	√	√	√		√	√	√
37	Remote software and database updates	Connect 4.0 Version	Connect 4.0 Version	Connect 4.0 Version		Connect 4.0 Version	Connect 4.0 Version	Connect 4.0 Version
38	Data transmission / reception (4.0)	optional	optional	optional		optional	optional	optional
39	HF01234YF Version	√	√	optional	optional	-	-	-
40	Printer	√	√	√	optional	optional	optional	optional
41	Dimensions, cm	62x57x132	56x61x132	56x61x132	56x61x132	56x61x132	50x91x139	50x91x139
42	Weight, kg	125	115	90	90	110	200	200



		CLEVER TOUCH	CLEVER ADVANCE		COUNTRY CLIMA ADVANCE		OK CLIMA ADVANCE	MONO CLIMA
		MIURA	PLUS	BASIC	220V	BIPOWER	404	220V
	Technical features							
1	Graphic display with icons	TOUCH Display 5"	√	√	√	√	√	√
2	Tank capacity	12,5 kg	12,5 kg	12,5 kg	10 kg	10 kg	30 kg	4,4 kg
3	Vacuum pump	100 lt/min	72 lt/min	72 lt/min	72 lt/min	72 lt/min	72 lt/min	3m³/h monostadio
4	Heater	BST System	BST System	BST System	automat.	automat.	-	-
5	Compressor capacity	300 gr/min	300 gr/min	300 gr/min	300 gr/min	300 gr/min	oilless	250 gr/min
6	Automatic recovery	√	√	√	√	√	√	manuale
7	Automatic oil discharge >95%	√	√	√	√	√	√	manuale
8	Programmable vacuum	√	√	√	√	√	√	manuale
9	Programmable vacuum test (in mbar)	√	√	√	√	√	√	-
10	Oil/additive standard injection, with scale	3 injectors	3 injectors	temporizzato	temporizzato	temporizzato	temporizzato	manuale
11	Injection oil/additive for hybrid vehicles, with scale	√	√	-	-	-	-	-
12	Software for hybrid vehicles	√	√	-	-	-	-	-
13	Automatic gas charge	BST System	BST System	BST System	√	√	-	manuale
14	Automatic pressure test	√	manual	manual	manual	manual	manual	-
15	Guided charge compensation manual WSC	√	-	-	-	-	-	-
16	Automatic Multipass	√	√	-	-	-	-	-
17	Built-in database (cars, industrial vehicles, agricultural machines)	√	√	√	√	√	√	-
18	Personal database	√	100 entries	100 entries	100 entries	100 entries	100 entries	-
19	Automatic selection of charging hoses	√	-	-	-	-	-	-
20	Discharge of incondensable gases	√	-	-	-	-	-	-
21	Automatic internal cleaning	√	√	√	√	√	√	-
24	Software for flushing cleaning (with kit 01.000.96 on request)	√	√	√	√	√	√	-
25	Software for recycling cleaning (VW, Audi) (with kit 01.000.139 on request)	√	√	√	√	√	√	-
26	Leakage test with nitrogen (with kit 01.000.326 on request)	√	√	√	√	√	√	-
27	Gas analyzer HF01234YF set up	√	√	√	-	-	-	-
28	Phase and alarm lights	√	optional	optional	optional	optional	-	-
29	Database update via USB	√ Pen drive	√	√	√	√	√	-
30	Scale lock	√	√	√	√	√	-	-
31	CSP: Vehicle compressor protection with LP charge	√	-	-	-	-	-	-
32	Automatic gas recovery from hoses	√	-	-	-	-	-	-
33	Hoses' length adjustment	√	-	-	-	-	-	-
34	Mobile app as a remote control solution	√	-	-	-	-	-	-
35	Ethernet port	√	-	-	-	-	-	-
36	Set up for the 4.0 protocol	√	√	√	√	√	-	-
37	Remote software and database updates	√	Connect 4.0 Version	Connect 4.0 Version	Connect 4.0 Version	Connect 4.0 Version	-	-
38	Data transmission / reception (4.0)	√	optional	optional	optional	optional	-	-
39	HF01234YF Version	optional	optional	optional	optional	optional	-	-
40	Printer	√	optional	optional	optional	optional	optional	-
41	Dimensions, cm	50x52x95	50x52x95	50x52x95	58x55x98	58x55x98	59x61x112	50x40x115H
42	Weight, kg	75	69	69	69	69	95	50

BREEZE X4

DUAL TOUCH



Breeze X4 Dual Touch
Cod. 01.001.44

€6.700,00

Fully automatic A/C station for R134a and HF01234yf gas

Touch Screen Display	7"
Tank capacity	2 x 10,5 kg
Vacuum pump	100 lt/min
Compressor capacity	2 x 400 gr/min
Injection oil/additive by standard/hybrid vehicles with scale	2 x 3

- Easy HMI (Human-Machine Interface) facilitated by a 7" touch screen and an icon-view software (A)
- No internal contamination between the gases: two separate circuits with 4 hoses, 2 for R134 and 2 for 1234yf; 2 evaporators, 2 compressors, 2 condensers, 2 filters, 2 tanks
- Separate circuits for the treatment of different oils: 3 channels for R134a with scale + 3 channels for HF01234yf with scale (standard, used, hybrid)
- Automatic circuit washing at every oil change
- Easy charge in all temperature conditions thanks to the BST system (by SPIN)
- WSC (Winter-Summer-Compensation) function. Possibility to correct the amount of gas loaded by scrolling the +/- keys and using the HP/LP pressure control (B)
- Integrated database upgradeable from USB port
- Maximum efficiency during recovery thanks to the standard "MULTIPASS" function (C)
- Flush kit **€340,00** A/C system (kit 01.000.96 on request)
- Recycling cleaning of **€960,00** AUDI/VW type (kit 01.000.139 on request)
- Leak detector **€266,00** in/hydrogen (kit 01.000.326 on request)
- Optional R1234yf refrigerant and **€2.250,00** SAE/VDA norms (kit cod. 01.000.263)
- Printer included
- Scale lock

SPIN CONNECT 4.0

Built-in WiFi module + SD Card
Cod. 01.000.328*



COMING SOON...

€242,00

*to be ordered at the same time as the A / C station

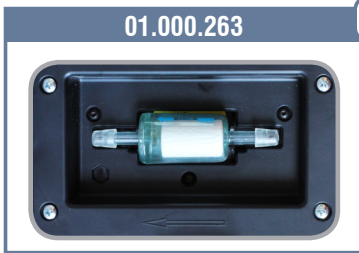
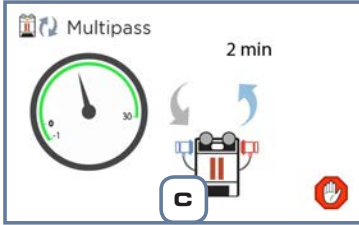
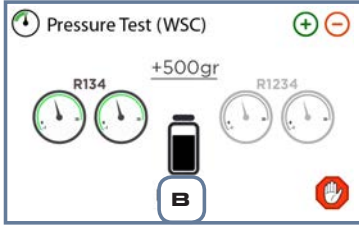
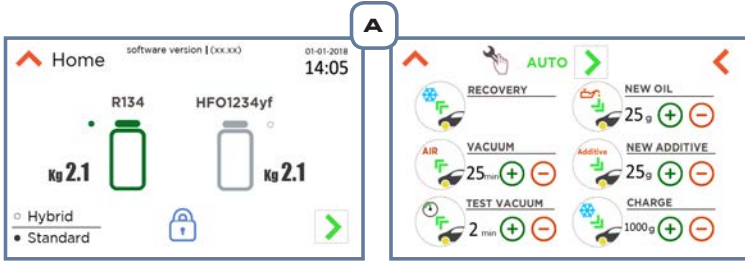

BETTER PERFORMANCE IN RECOVERY AND CHARGE

BST
SYSTEM



R 134a



HFO 1234yf

BREEZE ADVANCE DUAL



Tank capacity	2 x 10,5 kg
Vacuum pump	100 lt/min
Compressor capacity	400 gr/min
Injection oil/additive by hybrid vehicles	3+1
4 quick couplings	2 x R134a / 2 x R1234yf
Printer	standard included

- **A:** Touch Screen Display
- Double tank (2x10,5 kg) with 2 electronic scales
- Facilitated charge in each temperature condition with **BST system** (by SPIN)
- **B:** Built-in database (cars, trucks, agricultural machines) with possibility to upgrade
- **D:** Hose length adjustment
- **E:** Printer included
- Automatic washing of the station's system at each gas change (time adjustable by the use)
- Automatic leak test on power up
- **F:** Flushing cleaning of the A/C system (kit 01.000.96 on request) €340,00
- **G:** Recycling cleaning of the A/C system, AUDI/VW type (kit 01.000.139 on request) €960,00
- **H:** Leakage test with nitrogen/hydrogen (kit 01.000.326 on request) €266,00
- **I:** User management
- **L:** Optional R134a / R1234yf dual refrigerant analyzer compliant with SAE / VDA norms (cod. 01.000.263) €2.250,00
- **M:** Standard and Hybrid oil management with automatic cleaning of the hoses
- **N:** Multilingual software
- **O:** Data download from USB port
- Scale lock
- WiFi module for data transmission / reception - kit 01.000.328 on request*

Breeze Advance DUAL Printer Cod. 01.001.43

€4.800,00

Fully automatic A/C station for
R134a and HF01234yf gas



**BST
SYSTEM**

SPIN CONNECT 4.0

Built-in WiFi module + SD Card
Cod. 01.000.328*



€242,00

*to be ordered at the same time as the A/C station

MADE IN ITALY



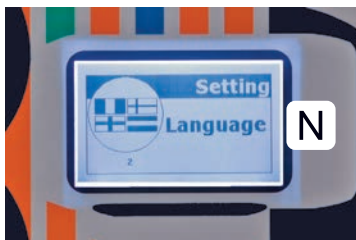
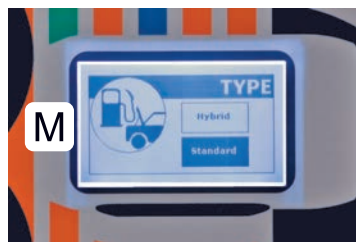
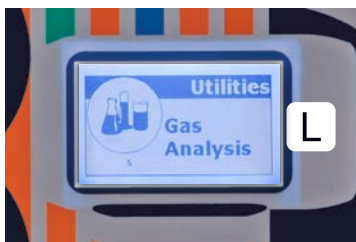
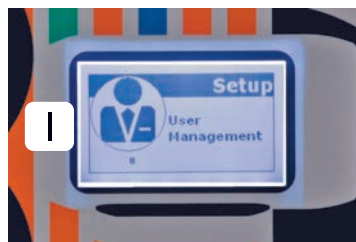

01.000.96



01.000.139

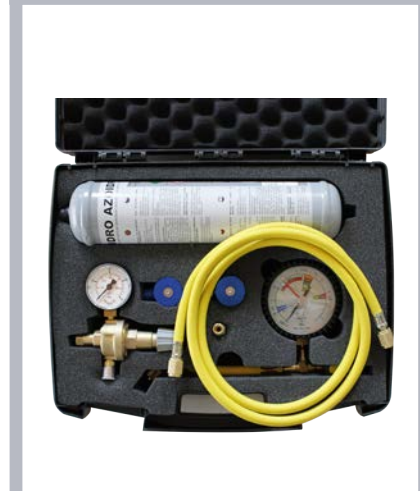

01.000.326



01.000.263

Optional accessories

BREEZE ADVANCE



MADE IN ITALY

Display	graphic
Tank capacity	22 kg (30 kg - for the BUS model) with automatic heater
Vacuum pump	170 lt/min
Compressor capacity	400 gr/min (600 gr/min - modello BUS)
Injection oil/additive by hybrid/standard vehicles	with scale (3 injectors)
Printer	optional (mod. PLUS / BUS) €140,00 standard (mod. EVO)

- **A:** Graphic display
- **B:** Built-in database (cars, trucks, agricultural machines) with possibility to upgrade
- Facilitated charge in each temperature condition with **BST system** (mod. PLUS / EVO)
- **C:** Pressure test with charge adjustment (manual WSC) mod. EVO
- **D:** Hose length adjustment
- **E:** Printer included (mod. EVO)
- **F:** Flushing cleaning of the A/C system (kit 01.000.96 on request) **€340,00**
- **G:** Recycling cleaning of the A/C system, AUDI/VW type (kit 01.000.139 on request) **€960,00**
- **H:** Leakage test with nitrogen/hydrogen (kit 01.000.326 on request) **€266,00**
- **I:** User management
- **L:** Automatic Multipass (mod. EVO)
- **M:** Standard and Hybrid oil management with automatic cleaning of the hoses
- **N:** Multilingual software
- **O:** Integrated USB for data download
- Optional R1234yf refrigerant analyzer compliant with SAE / VDA norms (cod. 01.000.216) **€2.250,00**
- Scale lock
- Optional WiFi module for data transmission / reception - kit 01.000.328* (mod. PLUS / EVO)

SPIN CONNECT 4.0

Built-in WiFi module + SD Card
Cod. 01.000.328*



€242,00

*to be ordered at the same time as the A/C station

BREEZE Advance PLUS

R134a Cod. 01.001.30 **€3.765,00**

HF01234yf Cod. 01.001.36 **€3.865,00**

BREEZE Advance EVO Printer

R134a Cod. 01.001.32 **€4.100,00**

HF01234yf Cod. 01.001.35 **€4.250,00**

BREEZE Advance BUS

Cod. 01.001.33 **€4.250,00**

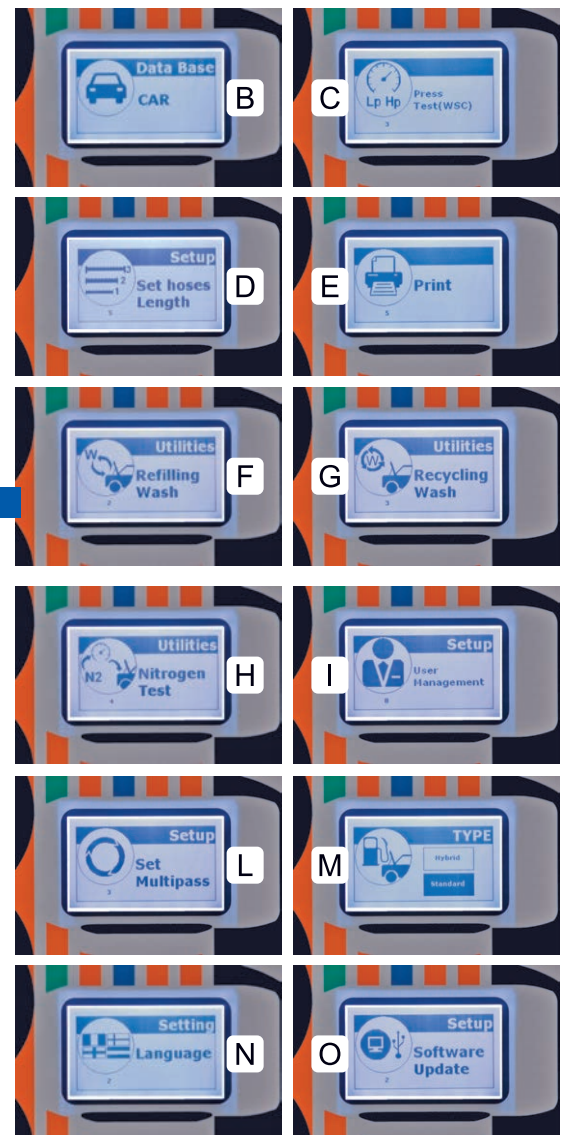

CLEVER ADVANCE



MADE IN ITALY

CLEVER Advance BASIC

R134a Cod. 01.018.30 € 2.750,00 + IVA

HF01234yf Cod. 01.018.35 € 2.850,00 + IVA

CLEVER Advance PLUS

R134a Cod. 01.018.32 € 3.050,00 + IVA

HF01234yf Cod. 01.018.37 € 3.150,00 + IVA

	BASIC	PLUS
Display	graphic	graphic
Tank capacity	12,5 kg	12,5 kg
Vacuum pump	72 lt/min	72 lt/min
Compressor capacity	300 gr/min	300 gr/min
Injection oil/additive Standard	timed (2+1 injectors)	by scale (3+1 injectors)
Injection oil/additive Hybrid	di serie	di serie
Printer	optional € 140,00	optional € 140,00

- A:** Graphic display
- B:** Built-in database (cars, trucks, agricultural machines) with possibility to upgrade
- Facilitated charge in each temperature condition with **BST System** (by Spin)
- Standard and Hybrid oil/additive management (**Multi-Oil System** by SPIN) – mod. BASIC
- D:** Hose length adjustment
- E:** Printer on request € 340,00
- F:** Flushing cleaning of the A/C system (kit 01.000.96 on request) € 960,00
- G:** Recycling cleaning of the A/C system, AUDI/VW type (kit 01.000.139 on request) € 266,00
- H:** Leakage test with nitrogen (kit 01.000.326 on request)
- I:** User management
- N:** Multilingual software
- O:** Integrated USB for data download
- Optional R1234yf refrigerant kit compliant with SAE / VDA norms with cod. 01.000.205 - € 2.250,00
- Scale lock
- Optional WiFi module for data transmission / reception - kit 01.000.328*

	01.000.96
	01.000.139
	01.000.326
	01.000.205
Optional accessories	

The pictures have merely explanatory purposes and can be changed with no warning

SPIN CONNECT 4.0

Built-in WiFi module + SD Card
Cod. 01.000.328*



€ 242,00

*to be ordered at the same time as the A/C station

CLEVER

COMING SOON...

Miura



Dispay	12,5 kg
Tank capacity	100 lt/min
Vacuum pump	300 gr/min
Injection oil/additive by hybrid/standard vehicles	with scale (3 injectors)
Software for electric compressors (hybrid)	included
Data transfers to PC via USB key or wireless	included
Scale lock	included
Printer	included
Dimensions / Weight	50x52x95 cm / 75 kg

- **A:** 5" Touch Screen display with intuitive icons
- Automatic HP/LP valves
- **B:** WSC function (Winter-Summer-Compensation): possibility of correcting the quantity of charged gas, by +/- keys and pressure control
- **C:** Max. recovery efficiency thanks to the standard Multipass function
- Facilitated charge in each temperature condition with **BST system** (by SPIN)
- **D:** Integrated database updateable by the USB key (from USB port on the control panel)
- Automatic internal circuit washing at each oil change (PAG-POE)
- **E:** Remote access from smartphone bei special App (optional wireless repeater)
- **F:** 230V panel socket (for connection with the optional wireless repeater)
- **G:** Ethernet cable (standard) and wireless repeater (optional)
- 4.0 protocol as standard
- **H:** Phase and alarm lights
- CSP vehicle compressor protection and LP charge
- Automatic recovery from the hoses at the end of the pressure test
- Flushing cleaning of the A/C system - kit 01.000.96 on request € 340,00
- Recycling cleaning of the A/C system, AUDI/VW type - kit 01.000.139 on request € 960,00
- Leakage test with nitrogen/hydrogen - kit 01.000.326 on request € 266,00
- Optional R1234yf refrigerant analyzer compliant with SAE / VDA norms - cod. 01.000.216 € 2.250,00



Clever Miura Printer R134a

Cod. 01.018.60

€3.570,00

Clever Miura Printer R1234yf

Cod. 01.018.61

€3.670,00

CLEVER *Miura*

A

software version 1.1 12-10-2012 14:05

Made in ITALY

R134 **21.1 Kg**

● Hybrid ○ Standard

GO

B

500gr 500gr

BACK

C

Language Multipass Tubi recupero

Software update Lungh. Tubi File Transfer

BACK NEXT

D

Automobili Macchine agricole

Camion Personale

BACK

E

Audi

Bora 1997-1999 Candy 1998-2011 Candi Life >2010 Golf V 1999-2010 Golf VI 1998-1999 Golf VI 1998-1999

GO

F

Kubota LAND ROVER Landini

IVECO MAGIRUS

BACK

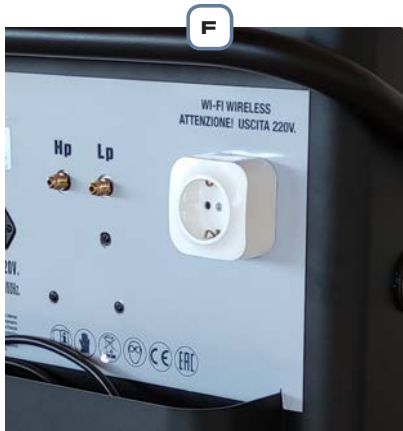

01.000.96



01.000.139

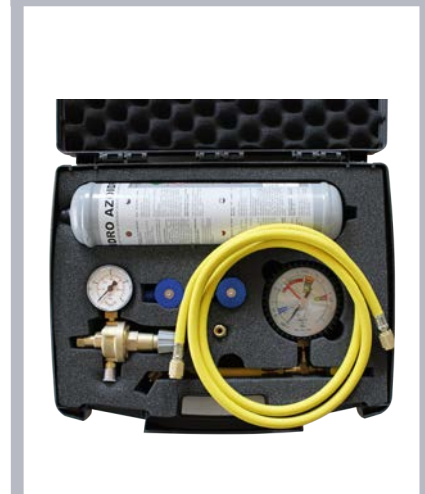

01.000.326



01.000.216

Optional accessories

COUNTRY CLIMA ADVANCE

Full automatic A/C station for agriculture and earth-moving machines

Tank capacity	10,5 kg
Vacuum pump	72 lt/min
Compressor capacity	300 gr/min
Injection oil/additive	timed
Printer	optional €140,00
R1234yf version	on request
12 V DC – 230 V AC	BIPOWER Version only

- 4.3" graphic display with icons
- Database for cars, trucks, agricultural and earth-moving machines (user-modifiable)
- Personal database (100 entries)
- Software for automatic A/C system flushing
- Heater
- Scale locking system for transport
- Charging hoses SAEJ 2196 of 5 m with LP and HP couplings and taps
- Statistic software of refrigerants and oils
- Database update via USB
- Power supply: 230 V AC
- Dimensions: 58x55x98 cm
- Weight: 60 kg

THE DETAILS THAT MAKE THE DIFFERENCE:

- BIPOWER Version (230 V AC-12 V DC by inverter) on request
- Transport handles for uneven grounds
- Manual/automatic cycle graphic display
- Software for A/C installation flushing cleaning (01.000.96 on request) €340,00
- Leakage test under pressure with nitrogen with kit (01.000.326) €266,00
- Setting of the hose length
- Software for internal cleaning of the station



NEW!

Country Clima Advance
Cod. 01.040.15

€3.100,00

NEW!

Country Clima Adv BIPOWER
Cod. 01.040.17

€3.500,00



MADE IN ITALY

ASTRABUS ADVANCE

Full automatic A/C station for buses

External tank capacity	40 kg (removable with automatic heating)
Vacuum pump	260 lt/min
Compressor capacity	1000 gr/min
Injection oil/additive	timed
Printer	optional €140,00

- 4.3" graphic display with icons
- Database for cars, trucks, agricultural and earth-moving machines (user-modifiable)
- Personal database (100 entries)
- Software for automatic A/C system flushing
- D: HP / LP multiscale gauges (R134a, R22, R404, R407)
- G: Optional reinforced pump for a fast automatic charge (15lt /min)
- H: Hoses length's setting
- Software for A/C installation flushing cleaning (01.000.96 on request) €340,00
- I: Leakage test with nitrogen (kit 01.000.236 on request) €266,00
- J: Possibility to operate in manual or Full Automatic mode
- K: Hermetic air compressor (27cc capacity, 1000gr /min)
- L: Optional Printer
- M: Multilingual Software
- N: Software update with USB port



Astrabus Advance R134a
Cod. 01.006.03

€6.150,00

Astrabus Multigas
Cod. 01.007.03

€3.450,00



MONOCLIMA

- 220V 50Hz
- BIPOWER



DISPONIBILE IN
VERSIONI:
AVAILABLE IN VERSIONS:
**220V 50Hz
BIPOWER**

EN

Manual a/c station for R134a for service on agricultural machines, earth-moving machines and boats with power supply 220V 50Hz or 12V DC (with Bipower kit)

- Compressor for recovery with automatic oil recovery system
- 3m³/h single/stage vacuum pump
- 4,4kg charge cylinder with heating resistance and safety valve
- Fresh oil injector
- 4-way manometric group with pressure gauges ø 80mm Pulse free
- Recovery capacity: 400gr/min
- Hose L=2mt
- Power supply: 220 V 50 Hz/12 V DC
- Dimensions: 50x40x115H cm
- Weight: 50 Kg



Versione / Version 12V DC-220V AC
Cod. 01.009.02

MONOCLIMA 220V 50Hz

COD. 01.009.01

€ 2.250,00

MONOCLIMA BIPOWER 12V DC-220V AC

COD. 01.009.02

€ 2.650,00

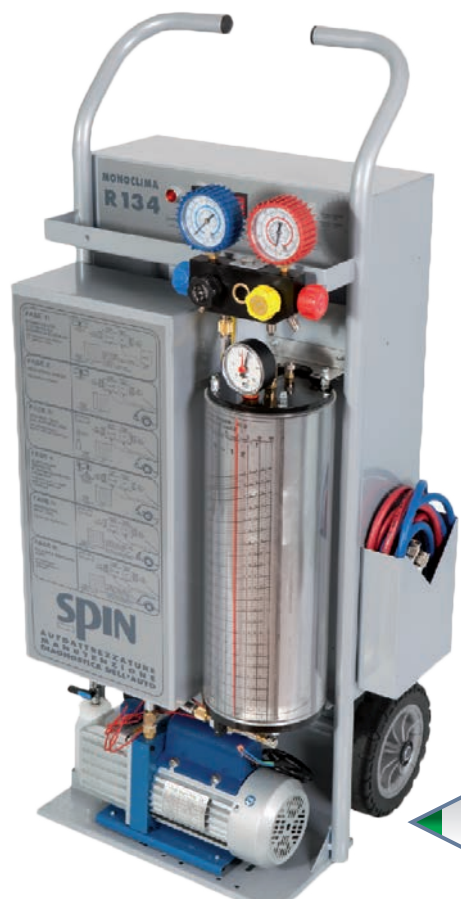



MOBILE REFRIGERATION

OK CLIMA ADVANCE 404 TRUCK

COD. 01.019.41

€ 3.990,00

EN Full automatic A/C stations for the service of systems with refrigerants R404a/R407c (mobile refrigeration)

- Graphic display
- 30 Kg tank
- 72 lt/min pump
- Oilless compressor
- Automatic recovery and charge
- Timed automatic oil injection
- Suitable for refrigerators with capacity up to 12 kg
- Graphic display
- Printer (optional)
- User management
- Multilingual software
- Integrated USB for data download
- Dimensions: 59x61x112 cm
- Weight: 95 kg
- Transfer valve on external cylinder additional (cylinder not supplied)



Cod. 01.000.96

FLUSHING KIT

- > Kit di lavaggio impianti a/c con freon R134 ad ALLAGAMENTO
- > REFILLING flushing kit for a/c installations with freon R134

€340,⁰⁰



Cod. 01.000.235

- > Kit diagnosi per controllo stato dell'olio in impianti AC R134a
- > Diagnosis kit for checking the oil status in A/C R134a systems

€220,⁰⁰



Cod. 01.000.236

- > Kit diagnosi per controllo stato dell'olio in impianti AC R1234yf
- > Diagnosis kit for checking the oil status in A/C R1234yf systems

€238,⁰⁰

Cod. 01.000.240

RECYCLING FLUSHING KIT

- > Kit lavaggio impianti a/c a RICIRCOLO (A) con visualizzazione passaggio gas e inversione di flusso (B)
- > RECYCLING flushing kit for a/c installations (A) with the visualisation of the gas flow / reverse flow (B)

€880,⁰⁰



Cod. 01.000.139

RECYCLING FLUSHING KIT

- > Kit lavaggio impianti a/c a RICIRCOLO (tipo Audi, VW) completo di serbatoio esterno, tubi e valigetta
- raccordi bypass per valvole espansione e filtri

- > RECYCLING flushing kit for a/c installations (Audi/ VW-like) complete with external tank, hoses and case with by-pass fittings for expansions valves and filters

€960,⁰⁰



Cod. 01.000.265

- > Solo cassetta adattatori
- > The case with adapters only

€584,⁰⁰

Cod. 01.000.326

€266,00

NITROGEN KIT FOR A/C STATIONS SPIN

Leak-seeking kit with the N2H2 950 ml cylinder, not refillable, pressure reducer up to 20 bar, double scale pressure gauge with hose and tap, 1/4 SAE FF 80cm tube, "T" adapter, R134a and HFO1234yf LP adapters



Cod. 01.000.203M

€259,00

MULTI REFRIGERANT

N2-H2 Electronic Leak Detector (CFC, HCFC, HFO1234YF, R134A, N2-H2)



Cod. 01.000.225

€586,00

LEAK DETECTION KIT FOR A/C R134A AND R1234YF SYSTEMS

and refrigeration systems with a N2-H2 mix (95%/5%) and electronic leak detector



Cod. 01.090.08

€327,00

PRESSURIZATION SYSTEMS KIT WITH NITROGEN-HYDROGEN N2-H2

Same as cod. 01.000.225, but without the leak detector for hydrogen H2



Cod. 01.090.07

€37,20

Nitrogen-Hydrogen N2-H2 Cylinder (95%/5%), 950cc. Not rechargeable



Cod. 01.090.16

€515,00

10 lt Refillable Nitrogen-Hydrogen N2-H2 Cylinder (95%/5%), 200 bars



Cod. 01.090.13

€68,00

2 lt Nitrogen-Hydrogen N2-H2 Cylinder (95%/5%), 110 bars. Not rechargeable.

OILS AND ADDITIVES



Cod. 01.000.39

€27,00

21CR (RL 100)
> POE 100 Oil, 1 lt



Cod. 01.000.252

€28,00

PAG PREMIUM
> Olio PAG PREMIUM, 1 lt,
per impianti R134a/HF01234yf



Cod. 01.000.253

€32,00

PAG PREMIUM + ADDITIVO
> PAG PREMIUM Oil with ADDITIVE, 1 lt,
for R134a/HF01234yf a/c systems



Cod. 01.000.254

€30,00

ADDITIVO
> Universal additive, 250 ml,
for R134a/HF01234yf a/c systems



Cod. 01.000.255

€28,80

ADDITIVO
> Kit 12 syringes, 7.5 ml with the universal additive
+ 2 adapters (R134a / HF01234yf)



Cod. 01.000.37

€12,00

AV 68R
> Vacuum pump oil, 0,5 lt



Cod. 01.000.242

€44,00

COOL-SHOT ULTRA
> Performance enhancer for air conditioning and refrigeration
systems



Cod. 01.000.241

€39,00

EXTREME ULTRA
> High performance innovative leak stop for vehicles A/C system

HYBRID



Cod. 01.000.125

€39,50

21CR POE100
> Oil for HYBRID compressors, 1lt



Cod. 01.000.124

€38,00

ADDITIVO
> U/V leak detector dye for A/C systems
for HYBRID vehicles, 350 ml, solvent free



Cod. 01.000.127

€33,00

ADDITIVO
> U/V leak detector dye for A/C systems for HYBRID
vehicles, 12 x 7,5 ml, with adapter, solvent free



Cod. 01.000.07

Price on request

Refrigerant R134a (refillable 12 kg bottles)
according to the availability



Cod. 01.000.07

€7,00

High pressure adapter for the rechargeable R134a bottle



Cod. 01.000.249

Price on request

Refrigerant R134a (refillable 5 kg bottles)
according to the availability



Cod. 01.000.249

Price on request

Refrigerant HF01234yf in refillable 5 kg bottle, rapid coupling included
according to the availability



Cod. 01.000.208

€18,50

High pressure adapter for the rechargeable R134a bottle



Cod. 01.000.01 Art. 7CR

€6,00

Adapter for freon bottles 1/4 SAE to connect the station to the gas bottle



Cod. 05.073.24T

€32,²⁰

U/V flashlight + goggles,
3x1,5V batteries included



Cod. 05.073.25T

€60,⁰⁰

Rechargeable U/V lamp & goggles

- Battery Li-ion 3,7V 2200mAh
- Insulation IP65
- Complete with AC battery charger and cigarette lighter plug 100/240 V AC
- Functions: 100% - 50% - SOS - OFF



Cod. 01.000.267

€61,⁰⁰

A/C SERVICE KIT

Annual maintenance kit for spin a/c stations
(excl. Astrabus):

- 0,5lt vacuum pump oil
- Filter
- 10 gaskets for a/c service hoses

Cod. 01.000.07

€7,⁰⁰

Gaskets kit for a/c service hoses



Cod. 01.000.49 Art. 49CR

€140,⁰⁰

Kit of valves and spare parts
for R134 A/C systems, multi-brand

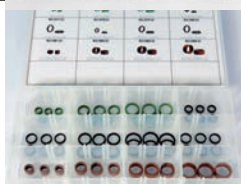

Cod. 01.000.136 Art. 47.4CR

€89,⁰⁰

Special o-rings kit (double o-rings)



Cod. 01.000.15

€26,⁰⁰

Kit o-rings 120pcs mixed



Cod. 01.000.95

€48,⁰⁰

Hose release kit for GM/Audi VW a/c systems, 4 pcs



Cod. 01.000.95

€48,⁰⁰

Hose release kit for Toyota a/c systems (A+B+C)



Cod. 05.073.24TK

€92,²⁰

R1234yf

R134a



Cod. 05.073.25TK

€120,⁰⁰

R1234yf

R134a



Cod. 01.000.17 Art. 17.1CR

€34,⁰⁰

Flexible hose with valve and 1/4 SAE couplings and tap.
Length = 3 mt, (specify the colour!)



Cod. 01.000.19 Art. 17CR

€28,⁰⁰

Flexible hose with 1/4 SAE couplings.
Length = 3 mt, (specify the colour!)

R134a



Couple of LP+HP
quick couplings
for R134a, with taps

Cod. 01.000.08

€78,⁰⁰

Made in EU

Cod. 01.000.08IMP

€41,⁰⁰

Imported

R1234yf



Couple of LP+HP
quick couplings
for R1234yf, with taps

Cod. 01.000.168

€93,⁰⁰

Made in EU

Cod. 01.000.168IMP

€49,⁰⁰

Imported



Cod. 01.000.197

€80,⁰⁰

Couple of high-pressure rapid couplings for BMW5,
Ford CMax, Volvo C30 cars

R134a and R1234yf Analyzer

Cod. 01.000.290

€2.990,00

TECHNICAL FEATURES

- 3.5" graphic interface with multilingual software
- Dual power supply (12V DC - 100 / 240V)
- Standard printer (A)
- Internal chamber flushing pump
- Purity standards both according to VDA regulations (ok - not ok >95%) and with percentage of R134a or HFO1234yf gas and contaminants

STANDARD OUTFIT:

- LP couplings for R134a and HFO1234yf with transparent hoses (B)
- 12V DC red/black clamp (C)
- 100/240V 50/60Hz power supply (D)

R134a / HFO1234yf GAS ANALYZER



STANDARD ACCESSORIES

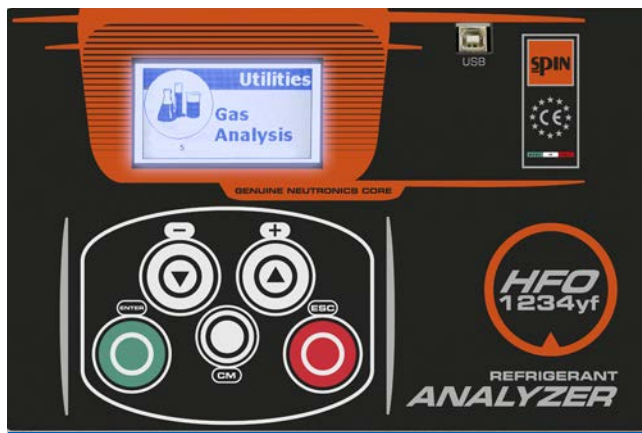

HFO1234yf refrigerant analyzer module

€2.250,00

Cod. 01.000.216 (for BREEZE ADVANCE/CLEVER MIURA)

€2.300,00

Cod. 01.000.205 (for CLEVER ADVANCE)

- Measurement according to the SAE J2912 standard (% HFO and other gases present, R134a, R22, HC, air) and according to the VDA standard (purity $\geq 95\%$ ok / not ok)
- Accuracy $\pm 1\%$
- Original "Neutronics" module with the aspiration pump and transparent hoses with HFO1234yf LP adapter included
- 4.7" graphic display with icons and multilingual messages by the ADVANCE series A/C stations SPIN
- Possibility of printing the report (in versions with printer)
- According to SAE/VDA

HFO1234yf



HFO1234yf + R134a refrigerant analyzer module for A/C stations:

**BREEZE DUAL X4
BREEZE ADVANCE DUAL**

€2.485,00

Cod. 01.000.263

- Measurement according to the SAE J2912 standard (% HFO and other gases present, R134a, R22, HC, air) and according to the VDA standard (purity $\geq 95\%$ ok / not ok)
- Accuracy $\pm 1\%$
- Original "Neutronics" module with the aspiration pump and transparent hoses with HFO1234yf LP adapter included
- 4.7" graphic display with icons and multilingual messages by the ADVANCE DUAL and 7" by the DUAL X4 A/C Station
- Possibility of printing the report (in versions with printer)
- According to SAE/VDA

DUAL GAS HFO1234yf /R134a



Automatic Device with Printer for Washing of A/C and HVAC Systems

- EASY FLUSH PRO automatically performs several recirculating washing steps (direct and reverse) with final recovery and drying
- 5,5 lt/min flow pump, 20lt tank
- A: Interactive multi-language software. Available languages: IT/EN/HR/CZ/DK/D/F/PL/PT/RO/RU/SK/SL/ES/SW/HU
- Quality control of the washing product through a glass flow meter
- Final data printing
- Reusable sintered filter
- Rear connection to dried compressed air or nitrogen (Max 5bar inlet)
- 230V AC power supply
- Dimensions: 59x46,5x100 cm, Weight: 45Kg
- A: 10 Lt Alpha Flush (washing liquid) included (for orders: code 01.000.251. Alpha Flush, 10 lt, € 122,00)
- **A: 10 Lt Alpha Flush (washing liquid) included**
- **B: Selection of included adapters (for A/C and refrigeration systems)**

Easy Flush Pro

PER IMPIANTI A/C

EASY FLUSH PRO

Cod. 01.000.250

€2.500,00



MADE IN ITALY



CORREDO STANDARD

A



B



A RICHIESTA

Cod. 01.000.188

> Kit Nitrogen-Hydrogen N₂H₂ Cylinder (95%/5%) 950cc with pressure reducer



€180,00



MADE IN ITALY



OPTIONAL

Cod. 01.000.91

A/C Flushing liquid for Easy Flush (01.000.171S), 10 lt

€136,00



EASY FLUSH

Cod. 01.000.171S

€1.096,00

STANDARD ACCESSORIES

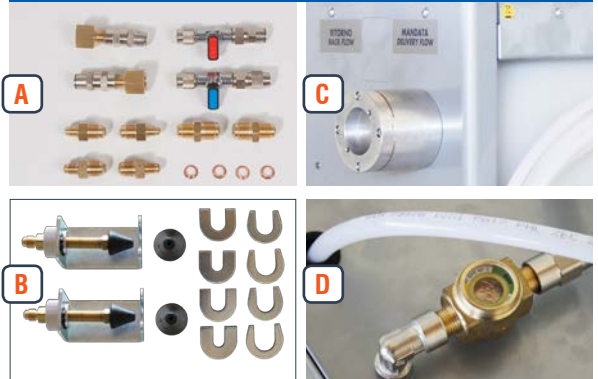

Standard accessories:

- **A:** ¼ sae, 3/8 sae, ½ sae couplings
- **B:** Kit of clamps and cone adapters for connection on hoses
- **C:** New sintered reusable filter
- **D:** Flow meter

TECHNICAL FEATURES

- Flushing liquid tank, 20 lt
- Coupling for external nitrogen bottle
- Flexible hoses, 3 mt
- Wheeled
- Voltage: 230 V 50/60 Hz
- Dimensions: 300x375x680 mm
- Weight: 19 kg



AFF



ATF X-DRIVE

02.023.65



MADE IN ITALY



ATF S-DRIVE 5000 SW

02.023.53



MADE IN ITALY



ATF S-DRIVE 4500 SW

02.023.90



MADE IN ITALY



ATF REMIN SW

02.023.57



MADE IN ITALY



ATF START SW

02.023.60



MADE IN ITALY



					
TECHNICAL FEATURES	X-DRIVE cod. 02.023.65	S-DRIVE 4500 SW cod. 02.023.90	S-DRIVE 5000 SW cod. 02.023.53	ATF START SW cod. 02.023.60	ATF RÈMIN SW cod. 02.023.57
Color touch display 5"	Tablet 8" 4G Wi-Fi	✓ 5"	✓ 5"	-	-
Monochromatic graphic display 240x64	-	-	-	✓	-
Software with icons easy to use	✓	✓	✓	✓	-
Multilingual software	✓	✓	✓	✓	-
Pump	1	1	2	1	1
Oil Measurement: 2 electronic scales	✓	✓	✓	✓	visual
Gearbox's outlet oil pressure measurement	✓	✓	✓	✓	✓
ATF's outlet oil pressure measurement	✓	-	✓	-	-
AWS function: Automatic new oil specific weight correction	✓	✓	✓	manual	-
Automatic Warm-Up function (starting of the automatic cycle upon reaching the min. optimal temperature)	✓	✓	✓	-	-
Washing of the new oil suction circuit	✓	✓	✓	-	-
Measurement of the waste oil temperature	✓	✓	✓	✓	-
Dipstick kit	-	-	✓	-	optional
Automatic additive injection	✓	✓	✓	guided manual	guided manual
Possibility to operate in automatic or manual mode	✓	✓	✓	semi-automatic	manual
Input flow reduction regulator (built-in)	✓	-	-	-	-
Integrated diagnosis with messages and related guide for the service	✓	-	-	-	-
Dual 12V DC and 220V AC power supply with low battery alarm and automatic power source recognition	✓	-	-	-	-
Software and database updatable via USB	WiFi	✓	✓	-	-
Flowmeters (old/new)	✓ backlight	✓ backlight	✓ backlight	transparent hoses, 3 mt	✓
New and waste oil tanks	2 x 20lt	2 x 20lt	2 x 30lt	2 x 20lt	2x20lt
New sintered reusable filter with magnet	✓ 2 filters	✓ 2 filters	✓ 2 filters	✓ 2 filters	✓ 2 filters
2 cases of couplings and hoses for European and Asiatic vehicles	✓	✓	✓	✓	v
Printer	✓	Optional	✓	Optional	-
Kit SmartPack (subscription for 12 months)	✓	✓	✓	✓	✓
Software for power steering oil change with optional adapters	-	✓	✓	-	-
Integrated database with brand, version, number of ratios, gearbox type, oil quantity, oil code; the connection to be used and the oil type/brand can be inserted manually by the operator	✓	✓	✓	-	-
Oil flow hose inversion	Automatic (internal)	Built-In	Built-In	Built-In	Built-In
Dimensions, mm	620x520x1210	360x440x1120	610x440x1120	620x510x1000	470x420x1020
Weight	75 kg	45 kg	45 kg	55 kg	50 kg

STANDARD ACCESSORIES

SmartPack Atf
ONLINE DATA BASE **NEW! 2021**

Online **DATA BASE** with technical information on automatic transmissions (diagrams, photos, location of fittings, etc.)





NOTE:

SMART PACK is provided free of charge with the purchase of an ATF SPIN and is valid for 12 months from the first activation. The renewal of the paid service is reserved for customers who have purchased an ATF SPIN.

Baccordi Atf
STANDARD ACCESSORIES



							
Cod. 02.022.52/new VOLVO V50		cod. 02.022.33/new JAP/MB/LANCIA	cod. 02.022.30/new JAP/BMW	cod. 02.022.31/new JAP/GM	cod. 02.022.32/new JAP/GM	cod. 02.022.29/new JAP/ALFA ROMEO	cod. 02.022.34/new JAP/VOLVO
							
Cod. 02.022.21/new DSG	Cod. 02.022.11/new AISIN	cod. 02.022.79/new JAP/MB/HUMMER/JEEP	cod. 02.022.84/new JAP/M14X1.5	cod. 02.022.37/new JAP/CITROEN/LANCIA	cod. 02.022.81/new JAP/1/8G	cod. 02.022.44/new BMW/MERCEDES 2001	cod. 02.022.80/new JAP/RUBBER HOSE FITTING
							
cod. 02.022.59/new BMW 8 MARCE/8 GEARS	cod. 02.022.98/new BMW 8 HP ZF	cod. 02.022.07/.18/.45/ new BMW 2010	cod. 02.022.09/new BMW 3 SERIES	cod. 02.022.18/new OPEL INSIGNA	cod. 02.022.63/new VW TIGUAN/PORSCHE 911	cod. 02.022.13/new AUDI Q5/Q7	cod. 02.022.99/new FIAT 500 X ZF
							
cod. 02.022.85/new DIPSTICK	cod. 05.090.82 MERCEDES BENZ 9G - TRONIC	Hoses for general applications				Hoses for general applications	
		cod. 02.022.25/new (ø 8) x 2		cod. 02.022.26/new (ø 10)	cod. 02.022.27/new (ø 12)	cod. 02.022.28/new (ø 14)	

ATF X-DRIVE

CONNECTION

ATF X-Drive
Cod. 02.023.65

€ 5.950,00

Oil Exchanger for Automatic Transmissions with the removable 8" Tablet for the remote control of functions (Bluetooth)

- 8" 4G Wi-Fi Tablet
- Direct consultation of the database online (by 4G or Wi-Fi)
- Remote control of functions and monitoring of ongoing operations via the ATF's removable tablet
- Guided information for the user
- Integrated database
- Automatic oil flow recognition and inversion (electronically)
- Input flow reduction regulator (built-in)
- Integrated diagnosis with messages and related guide for the service
- Improved procedure for replacing new oil tank (other tanks on request)
- Guided functions for manual procedure
- Funzioni guidate for radiator washing procedure and filter replacement
- Specific procedure for DSG
- Dual 12V DC and 220V AC power supply with low battery alarm and automatic power source recognition
- Printer included
- Direct access to waste oil for pan emptying
- Kit of fittings and hoses for European and Asian cars



MADE IN ITALY



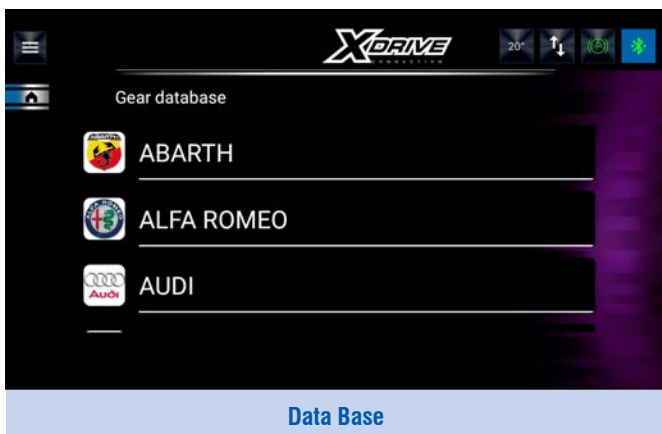
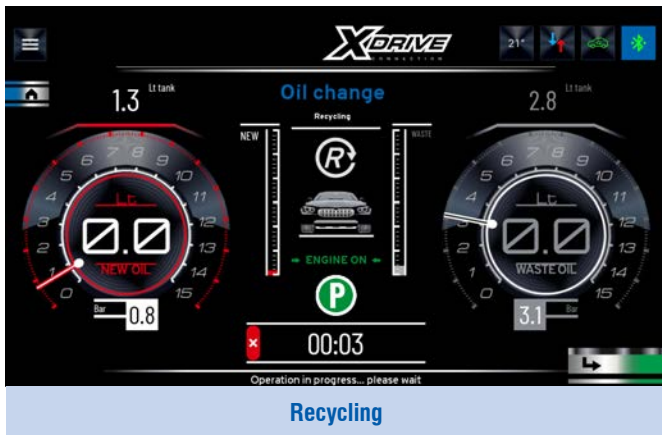
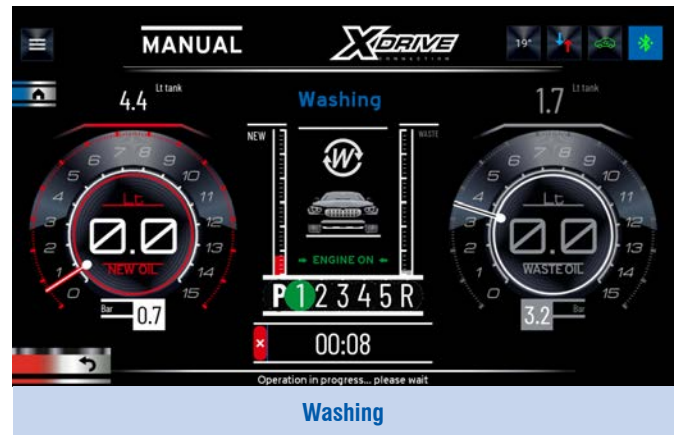
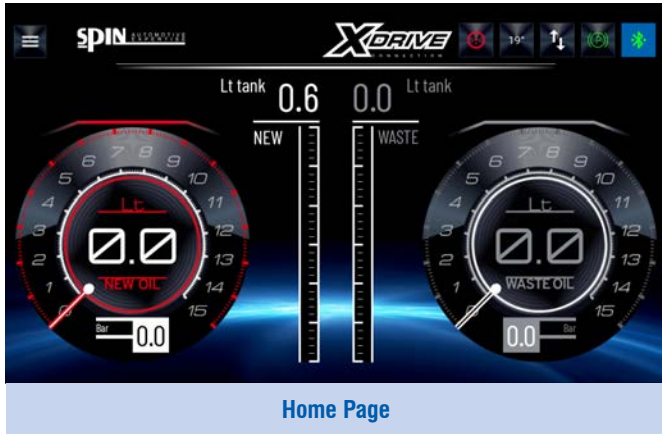

Le immagini dei prodotti possono essere soggette a variazione senza preavviso



- **A:** 5" color touch display
- **A:** Gearbox outlet oil pressure measurement
- **A:** ATF's outlet oil pressure measurement
- **B:** Multilingual software
- **C:** AWS function: Automatic new oil Weight Set
- **D:** Funzione warm-up automatico (avvio del ciclo automatico al raggiungimento della temperatura minima ottimale)
- **Integrated oil flow inversion system** **NEW!**
- **E:** Washing of the new oil suction circuit
- **F:** Dipstick kit
- **G:** Automatic additive injection
- **H:** Possibility to operate in automatic or manual mode
- **I:** Software and database updatable via USB
- **J:** Flowmeters with backlight (old/new)
- **K:** New and waste oil tanks
- **L:** 2 new sintered reusable filters with magnet **NEW!**
- **M:** Kit of couplings and hoses for European and Asiatic vehicles included
- **N:** Printer
- **O:** **SmartPack** (12 months of free access to the online Database)
- **P:** Software for power steering oil change
- **Q:** Integrated database with brand, version, number of ratios, gearbox type, oil quantity, oil code
- WiFi module for data transmission / reception - kit 01.000.328 on request*

ATF S-Drive 5000 SW
Cod. 02.023.53

€ 5.560,00



SPIN CONNECT 4.0

Built-in WiFi module + SD Card
Cod. 01.000.328*



COMING
SOON...

€242,00

*to be ordered at the same time as the ATF station

S-DRIVE 5000 SW

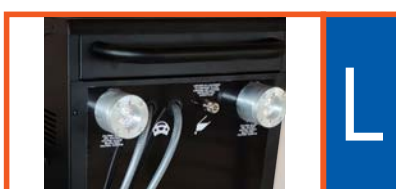
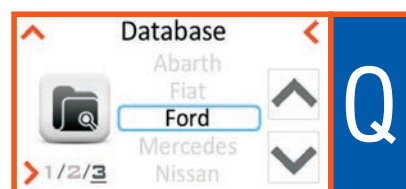
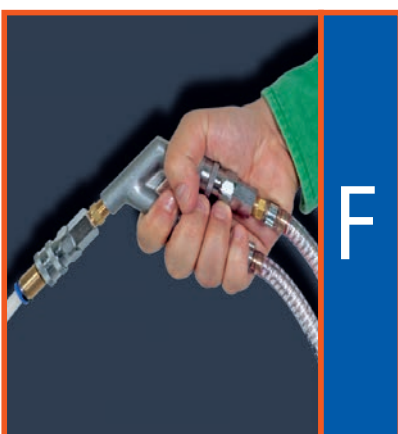
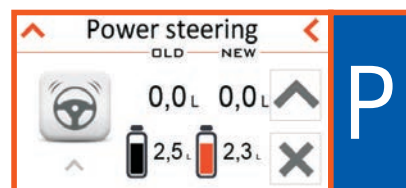
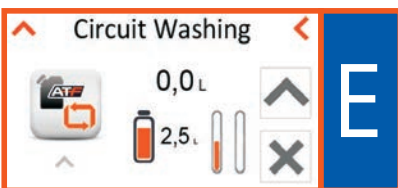
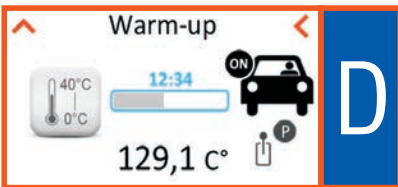
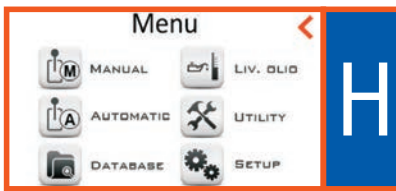



- **A:** Color touch display 5"
- **A:** Gearbox outlet oil pressure measurement
- **B:** Multilingual software
- **C:** AWS function: Automatic new oil Weight Set
- **D:** Funzione warm-up automatico (avvio del ciclo automatico al raggiungimento della temperatura minima ottimale)
- **Integrated oil flow inversion system** **NEW!**
- **E:** Washing of the new oil suction circuit
- **F:** 2 new sintered reusable filters with magnet **NEW!**
- **G:** Automatic additive injection
- **H:** Possibility to operate in automatic or manual mode
- **I:** Software and database updatable via USB
- **J:** Flowmeters with backlight (old/new)
- **K:** New and waste oil tanks
- **L:** Kit of couplings and hoses for European and Asiatic vehicles included
- **M:** **SmartPack** (12 months of free access to the online Database)
- **N:** Software for power steering oil change
- **O:** Integrated database with brand, version, number of ratios, gearbox type, oil quantity, oil code
- WiFi module for data transmission / reception - kit 01.000.328 on request*

SPIN CONNECT 4.0

Built-in WiFi module + SD Card
Cod. 01.000.328*



€242,00

*to be ordered at the same time as the ATF station

COMING
SOON...



ATF S-Drive 4500 SW
Cod. 02.023.90

€ 4.560,00



S-DRIVE 4500 SW

A



B

Language
 Czech
 Russian
Italiano
 English
 Spanish



C

Automatic Weight Set
 800 Lt tanica

H

Menu
 MANUAL LIV. OLIO
 AUTOMATIC UTILITY
 DATABASE SETUP

D

Warm-up
 40°C
 12:34
 129,1 C°

I

Pc connect
 2:34



E

Circuit Washing
 0,0 L
 2,5 L



N

Power steering
 OLD NEW
 0,0 L 0,0 L
 2,5 L 2,3 L



O

Database
 Abarth
 Fiat
Ford
 Mercedes
 Nissan



- **A:** Graphic display 240x64
- **A:** Control keyboard with only 4 buttons
- **A:** User-friendly software with icons
- Intuitive software that adapts to different operation mode of the workshop
- **B:** Multilingual software (22 languages)
- **A:** Measurement of the return pressure
- **C:** Selection of the oil specific weight (kg/lt)
- 2 electronic scales
- 1 pump, 220V50Hz (110V60Hz on request)
- Measurement of the oil temperature
- **D:** Possibility to operate in manual or full automatic mode
- **E:** Protection against overpressure with "automatic recirculation" at the beginning or end of charge
- **F:** Automatic length compensation of the hoses
- **G:** Possibility to update the software
- **H:** Manual additive injection
- **I:** Automatic hose inversion **(NEW!)**
- **J:** Transparent hoses for the oil flow control
- **K:** Case of couplings and hoses for European and Asiatic vehicles
- **L:** Removable new/old oil tanks, capacity 20lt
- **M:** 2 sintered magnetic filters (reusable) **(NEW!)**
- **N:** Optional printer
- **O:** SmartPack (12 months of free access to the online Database)

ATF START SW
Cod. 02.023.60

€ 3.800,00



MADE IN ITALY

ATF START SW

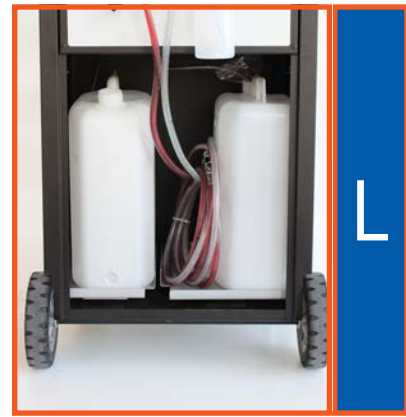

Atf RÉMIN manual

- **A:** Control panel with used oil pressure gauge, taps/phase switches and flowmeters
- **B:** Kit of couplings and hoses for European and Asiatic vehicles (standard included)
- **C:** **SmartPack** (12 months of free access to the online Database)
- **D:** 500ml additive injector with protection against operational errors
- **E:** **Automatic hose inversion** **NEW!**
- **F:** 20 liter removable oil containers for new/used oil
- **G:** 2 sintered magnetic filters (reusable) **NEW!**
- **H:** Magnetic litre-counters: Useful for visual control of the levels (used oil, new oil)
- **I:** Facilitated use of the appliance



MADE IN ITALY

ATF RÉMIN SW
Cod. 02.023.57

€ 2.800,00

ATF RÉMIN SPIN USER'S GUIDE					
	A	B	C	ATF PUMP	CAR ENGINE
VERIFY THE PRESSURE PRESENCE ON THE GAUGE				OFF	ON
ADDITIVE INJECTION				ON	OFF
CLEANING				OFF	ON
EMPTY THE OIL PAN				OFF	ON
REMOVE THE OIL PAN				OFF	OFF
RADIATOR CLEANING				ON	OFF
FILTER CHANGE & OIL PAN REMOUNT				OFF	OFF
FILL THE PAN WITH NEW OIL				ON	OFF
OIL CHANGE IN THE TORQUE CONVERTER ADJUST SLOWLY THE TAP				ON	ON
RESTORE THE CONNECTION				OFF	OFF
OIL LEVEL CONTROL A				ON	OFF
USED OIL DISCHARGE A				ON	OFF

ATF RÈMIN SW

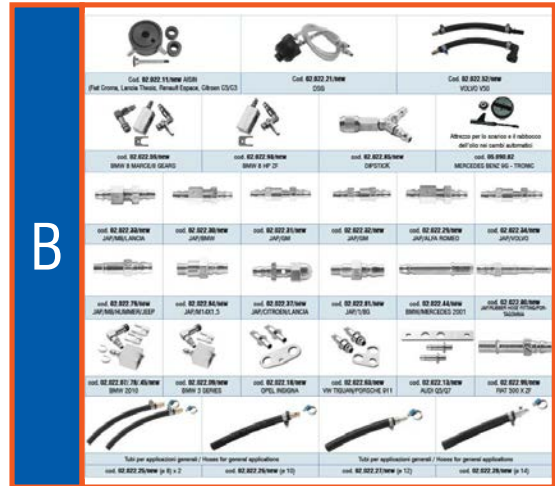
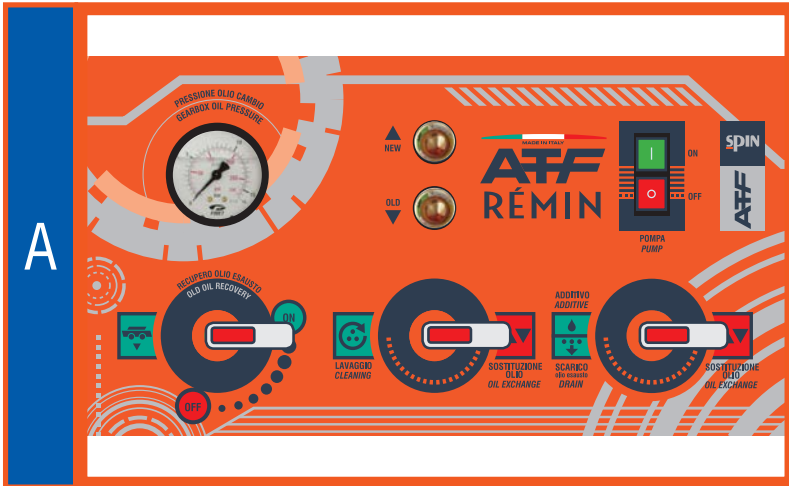

C

Go back to: Brands list | Go back to: Model search

Technical data for FORD - GALAXY - 2.0 DURATORQ TDCI (CA1)

Starting Year Ending year	2010 2015	AW Engine Type	102 DCT	Gearbox	APR8 8
Oil Oil Quantity (L)	WSS-M2C936-A 5.00	Transmission Cleaner	02.000.51	Quantity Additive	-

WSS-M2C936-A

Part: TMSR-8C001-AD Quantity: Adapter: 02.000.51 NEW OPTIONAL

SmartPack



Models available for Brand FORD

Model	GALAXY	Year	2011	Version	2.0 DCT	
FORD - GALAXY		Starting Year	2010	Ending year	2015	KW
GALAXY - 2.0 DURATORQ TDCI (GA1)		2010	2015	100		
GALAXY - 2.0 DURATORQ TDCI (CA1)		2010	2015	100		
GALAXY - 2.0 DURATORQ TDCI (CA1)		2010	2015	100		
GALAXY - 2.0 DURATORQ TDCI (GA1)		2010	2015	120		

Cannot find the model? Contact us

Go back to: Brands list



STANDARD COUPLINGS INCLUDED IN THE FOLLOWING MODELS:

ATF XDRIVE • ATF 5000 • ATF 4500 • ATF START • ATF REMIN

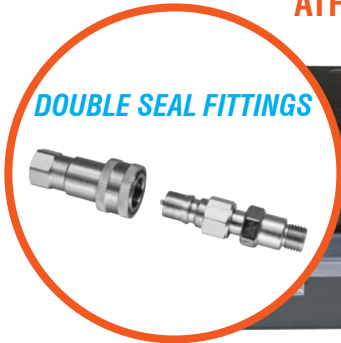

					
Cod. 02.022.11/new AISIN (Fiat Croma, Lancia Thesis, Renault Espace, Citroen C5/C3)		Cod. 02.022.21/new DSG		Cod. 02.022.52/new VOLVO V50	
					
cod. 02.022.59/new BMW 8 MARCE/8 GEARS		cod. 02.022.98/new BMW 8 HP ZF		cod. 02.022.85/new DIPSTICK	
					
cod. 02.022.33/new JAP/MB/LANCIA		cod. 02.022.30/new JAP/BMW		cod. 02.022.31/new JAP/GM	
					
cod. 02.022.79/new JAP/MB/HUMMER/JEEP		cod. 02.022.84/new JAP/M14X1,5		cod. 02.022.37/new JAP/CITROEN/LANCIA	
					
cod. 02.022.07/.78/.45/new BMW 2010		cod. 02.022.09/new BMW 3 SERIES		cod. 02.022.18/new OPEL INSIGNA	
					
cod. 02.022.25/new (ø 8) x 2		cod. 02.022.26/new (ø 10)		cod. 02.022.27/new (ø 12)	
					
cod. 02.022.29/new JAP/ALFA ROMEO		cod. 02.022.44/new BMW/MERCEDES 2001		cod. 02.022.80/new JAP/RUBBER HOSE FITTING	
					
cod. 02.022.32/new JAP/GM		cod. 02.022.81/new JAP/1/8G		cod. 02.022.13/new AUDI Q5/Q7	
cod. 02.022.25/new (ø 8) x 2		cod. 02.022.26/new (ø 10)		cod. 02.022.27/new (ø 12)	
					
cod. 02.022.28/new (ø 14)		Hoses for general applications		Hoses for general applications	

SMART PACK ATF
Cod. 02.022.110
€ 180,00

Online **DATA BASE** with technical information on automatic transmissions (diagrams, photos, location of fittings, etc.)

NOTE:

SMART PACK is provided free of charge with the purchase of an ATF SPIN and is valid for 12 months from the first activation. The renewal of the paid service is reserved for customers who have purchased an ATF SPIN.

OPTIONAL ACCESSORIES

Cod. 02.000.62

Kit for **USA/Japan vehicles**
(Ford, Cadillac, Toyota, Nissan, Chrysler
Jeep, GM, Dodge, Honda, Chevrolet, Chevy
Duramax)

€ 505,00

Cod. 02.022.66

Oil level refiller

€ 54,00
Cod. 02.022.04

Kit 2 oil level dipstick
Mercedes A-Class & C-Class

€ 55,00

Cod. 05.088.21

Service trolley for ATF accessories

€ 84,00
Cod. 05.090.82

Tool for draining and top up of oil in
automatic gearboxes of **Mercedes Benz**
9G - Tronic







€ 32,00

Optional ATF adapters

* 02.022.21/new		DSG	€ 80,00	02.022.88/new		Porsche Cayenne / VW Touareg / Audi Q8	€ 66,00
* 02.022.11/new		AISIN (Fiat Croma, Lancia Thesis, Renault Espace, Citroen C5/ C3)	€ 64,00	02.022.93/new		Audi 4/6 Avant >2012, 4G5 transmission	€ 92,00
* 02.022.52/new		Volvo V50	€ 46,00	02.022.94/new		Mercedes Benz, 722.9 transmission	€ 82,00
* 02.022.59/new		BMW 8 gears	€ 92,00	02.022.95/new		TF80 MULTI (Volvo, Alfa Romeo, Cadillac, Ford, Land Rover)	€ 80,00
* 02.022.98/new		BMW 8 gears, ZF transmissions	€ 79,00	02.022.97/new		Mercedes A/B-Class, DCT transmission	€ 78,00
* 02.022.99/new		FIAT 500X, ZF transmissions	€ 15,60	02.022.100		Water/fluid exchanger on Toyota Avensis K311, to be used with rubber hose Ø8	€ 75,00
02.022.61/new		Powershift (Volvo - Ford Focus)	€ 82,00	02.022.101		Water/fluid exchanger on Toyota Corolla, to be used with rubber hose Ø8	€ 72,00
02.022.62/new		Mercedes CLK	€ 60,00	02.022.102		Water/fluid exchanger on Mazda CX-5 (6 AT) to be used with rubber hose Ø8	€ 72,00
02.022.65/new		BMW 330D 180Hp	€ 60,00	02.022.104		Water/fluid exchanger on Nissan CVT (JF011E/REOF10A)	€ 75,00
02.022.72/new		Jatco for Nissan/Renault/Jeep/ Mitsubishi	€ 75,00	02.022.105		Water/fluid exchanger on Nissan 6CVT	€ 75,00
02.022.73/new		Renault-Nissan <2003, DPO transmissions	€ 70,00				
02.022.74/new		Audi A8	€ 38,00				
02.022.86/new		Volvo XC90	€ 60,00				

* Included as standard accessories with the purchase of any ATF model

Optional ATF adapters

02.022.107/new		Maserati	€ 89,00	02.022.132		ATF VW Polo	€ 76,00
02.022.108		Citroen C4/C5 PICASSO	€ 89,00	02.022.140/new		ATF piastra Toyota	€ 76,00
02.022.109/new		Renault Espace Application: RE0F06A	€ 78,00	02.022.141/new		ATF Alfa Romeo	€ 83,00
02.022.116		LAND ROVER Application: 7F09HP	€ 130,00	02.022.142/new		ATF Toyota Lexus	€ 76,00
02.022.117		PEUGEOT 3800	€ 115,00	02.022.143/new		ATF Toyota Lexus 2	€ 76,00
02.022.120		BMW/Mini/Volvo Application: AWF8F45 (TG-81LS)	€ 86,00	02.022.144/new		Volvo	€ 92,00
02.022.121/new		ATF Audi SQ5 2013	€ 17,00	02.022.145/new		VAG, Nissan, Suzuki	€ 97,00
02.022.122/new		ATF Range Rover 4.2	€ 97,00	02.022.146/new		Nissan, Citroen, Peugeot, Lancia, Alfa Romeo	€ 97,00
02.022.124/new		ATF Volvo V70	€ 90,00	02.022.147/new		PSA	€ 97,00
02.022.126/new		ATF Ford Range 3.2/Mazda B-Series	€ 70,00	02.022.148/new		Volvo 2	€ 80,00
02.022.131		ATF Škoda	€ 76,00	02.022.149/new		BMW/Mini/Suzuki Aisin	€ 97,00

Additivi per ATF



Cod. 02.000.51
ATF flushing additive, 350 ml

€ 12,00



Cod. 02.000.67
ATF flushing additive, 5 lt

€ 110,00

WS4000

RADIATOR CLEANING UNIT

Automatic Radiator Cleaning unit and replacement of cooling liquid for cars and commercial vehicles up to 3.5 tons

- Connection and washing procedure assisted by multilingual software.
Available languages: IT/EN/HR/CZ/DK/D/F/PL/PT/RO/RU/SK/SL/ES/SW/HU)

EXECUTABLE WORK PHASES:

- Air purging from the WS 4000 unit (specific program)
- Washing of the engine cooling circuit (after inserting the specific additive) through the appropriate injector; the washing is timed but with a duration that can be changed by the operator himself
- Replacement of the coolant with return to the internal tank, the status of the liquid is displayed on the two flowmeters on the panel
- Emptying of the internal tank with specific program
- Automatic pump bypass during the washing phase but with the possibility of activating the pump for the operator
- Possibility to print the following data (vehicle number plate, VIN, date/time, km)

TECHNICAL FEATURES

- > **A:** Connection and washing procedure assisted by multilingual software
- > **B:** Injector for the inserting of the specific additive
- > **C:** Status of the liquid is displayed on the two flowmeters on the panel
- > **D:** Printer (vehicle number plate, VIN, date/time, km)
- > 200V 50 Hz power supply
- > **E:** Emptying of the internal tank with specific program
- > Automatic internal liquid heater (3000W)
- > 2 x pressure gauges controlling inlet and outlet pressures
- > 2 x 20lt tanks
- > Maintenance alarm (filter cartridge replacement)
- > **F:** Kit of accessories and adapters for connection in series to the vehicle cooling system
- > The machine is equipped with 2 tanks "ZEUS" + 2 tanks "URAN"

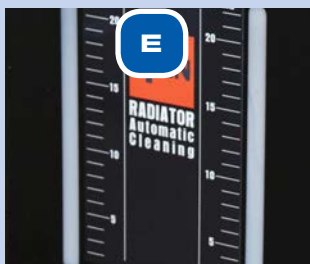
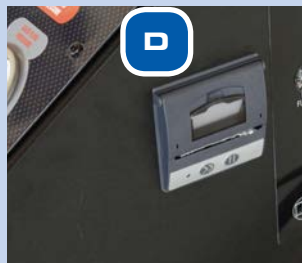

WS4000
Cod. 02.021.10

€ 2.500,00 +IVA



MADE IN ITALY

Cod. 02.000.98
Decarbonising flushing liquid, 500 ml, suitable for systems up to 8 Lt

€ 10,00

Cod. 02.000.99
Lubricant with anticorrosion protection, 500 ml, suitable for systems up to 8 Lt

€ 8,00

WS 3000 Plus

RADIATOR MAINTENANCE

WS3000 PLUS
Cod. 02.021.05

€ 1.630,00

Radiator cleaning bench. Equipped with a **thermostated heater** to keep the constant temperature while cleaning and replacing coolant liquid



WS3500

Cod. 02.021.11

€ 1.990,00 + IVA

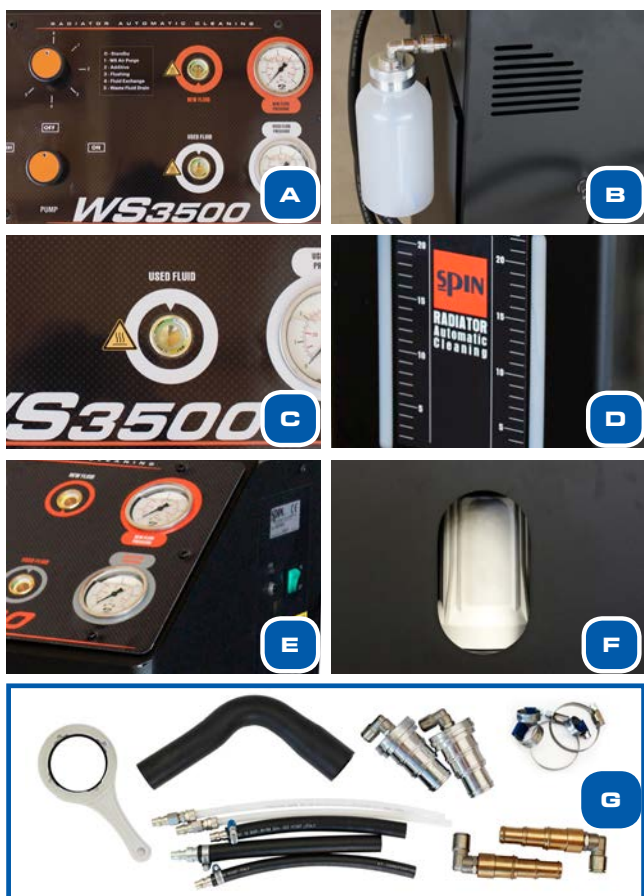

Cod. 02.000.98

Decarbonising flushing liquid, 500 ml, suitable for systems up to 8 Lt

€ 10,00



Cod. 02.000.99

Lubricant with anticorrosion protection, 500 ml, suitable for systems up to 8 Lt

€ 8,00

WS3500

RADIATOR CLEANING UNIT

IT APPARECCHIO DI LAVAGGIO E SOSTITUZIONE DEL LIQUIDO DI REFRIGERANTE MOTORE PER AUTO E VEICOLI COMMERCIALI FINO A 3.5 TONS

- > **A:** 2 manometri controllo pressioni in ingresso e uscita
- > **B:** Iniettore per l'inserimento dell'additivo decarbonizzante (ZEUS)
- > **C:** 2 flussimetri di controllo del liquido
- > **D:** 2 taniche da 20 lt
- > **E:** Alimentazione 200V 50 Hz
- > **F:** Filtro tessile interno a vista
- > **G:** Kit accessori e adattatori per collegamento in serie all'impianto di raffreddamento del veicolo
- > Riscaldatore automatico del liquido da 3000W interno

EN RADIATOR CLEANING UNIT AND REPLACEMENT OF COOLING LIQUID FOR CARS AND COMMERCIAL VEHICLES UP TO 3.5 TONS

- > **A:** 2 pressure gauges for inlet and outlet pressures
- > **B:** Injector with rapid coupling on the rear side for "Zeus" decarbonizing additive
- > **C:** 2 flow indicators on the panel
- > **D:** 2 tanks da 20 lt
- > **E:** 200V 50 Hz power supply
- > **F:** Removable internal textil filter
- > **G:** Kit of included couplings and hoses for the connection to the vehicle cooling system
- > Automatic internal liquid heater (3000W)



OXY MATE

OXY MATE
Cod. 02.013.13

NEW!
2021

€ 4.600,00

DETAILS THAT MAKE THE DIFFERENCE:

- Power supply 230V 50Hz (not from vehicle battery)
- High energy efficiency thanks to the modular system (patented) - picture A
- Body in stainless steel (AISI 316L)
- Intuitive 3" touch screen interface
- Vibration sensor for rpm reading (car running)
- Continuous control of the electrolyte density and signaling of the need to fill up the level of the water
- Suitable for Petrol / Diesel / LPG engines up to **3000cc**



HHO

MADE IN ITALY

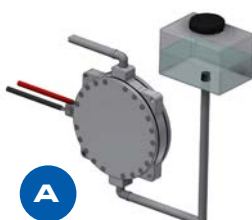

A



OXY MASTER

OXY MASTER
Cod. 02.013.12

NEW!
2021

€ 7.000,00

DETAILS THAT MAKE THE DIFFERENCE:

- Power supply 230V 50 Hz (not from vehicle battery)
- High energy efficiency
- Tank-electrolytic cell group in modular aisi 316 L stainless steel
- 10 "Touch interface with intuitive software
- Bluetooth rpm sensor (car running)
- WiFi-Bluetooth connection as standard
- Continuous control of the electrolyte density and signaling of the need to fill up the level of the water
- External bubbler filter (to avoid return of the flame)
- Suitable fo Petrol / Diesel / LPG engines up to **8000cc**



HHO

MADE IN ITALY



CARATTERISTICHE TECNICHE	 Cod. 02.013.13	 Cod. 02.013.12
Modello/Model	OXY MATE	OXY MASTER
Power supply	230V 50 Hz	230V 50 Hz
Max HHO Production	90 lt/h <10A 20°	384 lt/h a 20A
Tank capacity	3 lt	60 lt
Touch Screen Interface	3"	10"
WiFi / Bluetooth standard	—	✓
Electrolitic cell inox steel Aisi 316	✓	✓
Timer	0-90'	0-180'
Manual Cycle with	✓ adjust flow	✓ adjust flow
Automatic Cycle	✓	✓
Concentration rate electrolyte in not distilled water	3%	10%
Safety device		
Red button	✓	✓
Level sensor inside the tank	✓	✓
Automatic switchoff for >20 A	✓	✓
Vibration tachometer	✓	—
Tachometer with obd and bluetooth socket	—	✓
Dimensions, cm	38 x 27,5 x 65,5	60 x 60 x 105
Weight (kg)	29 kg	120 kg

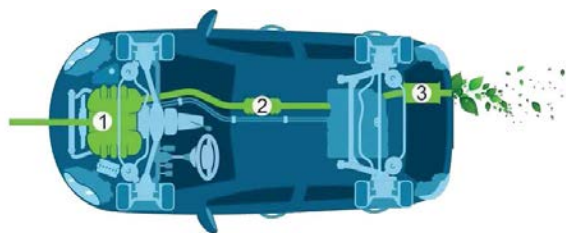

BENEFITS:

RETURN TO THE INITIAL PERFORMANCE

FUEL SAVE

INCREASE ENGINE'S POWER

CARBON DEPOSITS REMOVAL FROM:

- VALVES
- TURBO
- SPARK PLUGS
- INJECTORS
- EGR VALVES
- FAP OBSTRUCTIONS

BANCHETTO SMART

AUTOMATIC TEST BENCH FOR 12V / 24V ALTERNATORS

BANCHETTO SMART 12/24V

Cod. 02.004.20

€ 4.600,00

NEW!
2021

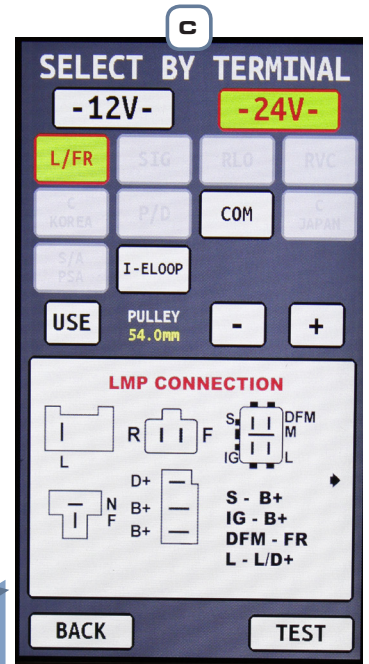
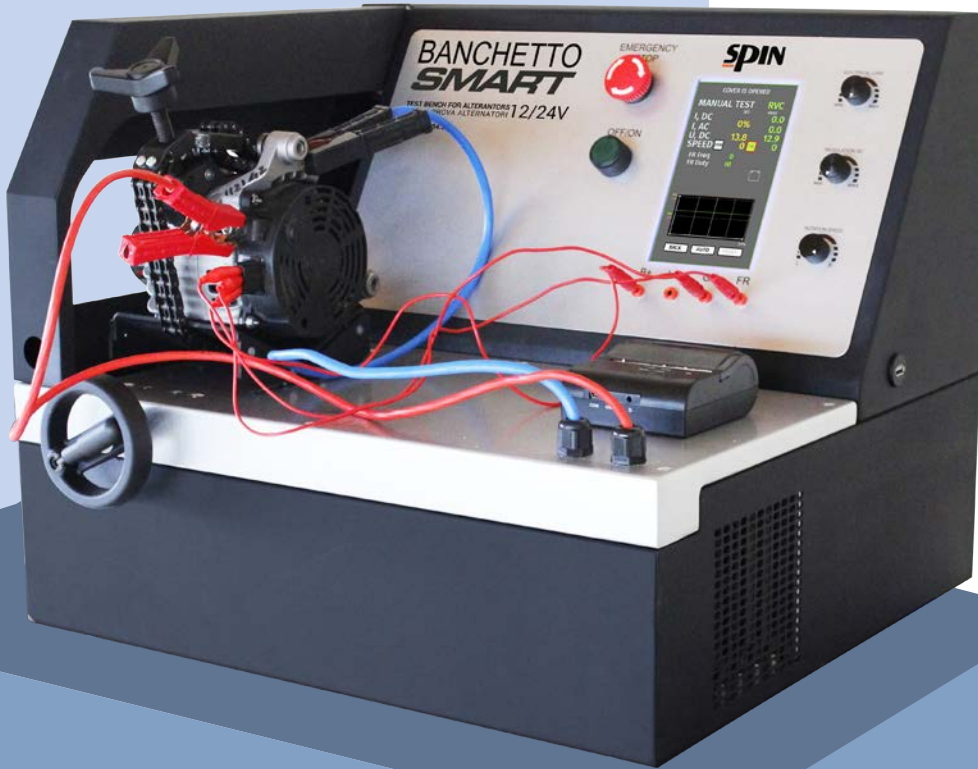

27/01/2021 15:39

MS006 COM ALTERNATOR TESTER



SELECT ALTERNATOR BY TYPE



SELECT ALTERNATOR BY NUMBER



SETTINGS



INFORMATION

MS006 - test bench for 12/24V alternators



BANCHETTO SMART

AUTOMATIC TEST BENCH FOR 12V / 24V ALTERNATORS

THE DETAILS THAT MAKE THE DIFFERENCE:

- Internal batteries not required
- Internal load rheostat 0-50 A (12V) e 0-25 A (24V)
- **A:** Color Touch Screen Display
- **B:** Database which allows to research the alternator by code and by type of protocol
- **C:** Graphic indication of the connectors and wires to be connected
- Setting function: possibility to adjust date/time and to perform manual/automatic tests
- Print report
- Oscilloscope function and trace printing
- Database upgradeable from USB port
- **D:** Bluetooth graphic printer included
- **E:** Kit of 9 OEM connectors included

Technical features:

- Power supply: 230V 50Hz
- Alternator test: 12V and 24V
- Motor power: 1.5 KW
- Adjustable load power (0-50A) to 12 V (0-25A) to 24V
- Motor speed range 0-3000 rpm
- Belt drive (V and Poly-V)
- Testable regulator protocols L/FR, SIG, RLO, RVC, C KOREA, P-D COM, LIN-BSS), C Japan
- **Measurements on the display:**
 - Voltage
 - AC
 - DC
 - Speed
- **For controllers with "com" socket:**
 - ID
 - Protocol
 - Speed
 - Regulator voltage type
 - Errors detected
 - Ø of the pulley
 - Graphic indication of the connection with the test cable
- Dimensions: 570x490x450mm
- Weight: 42 kg

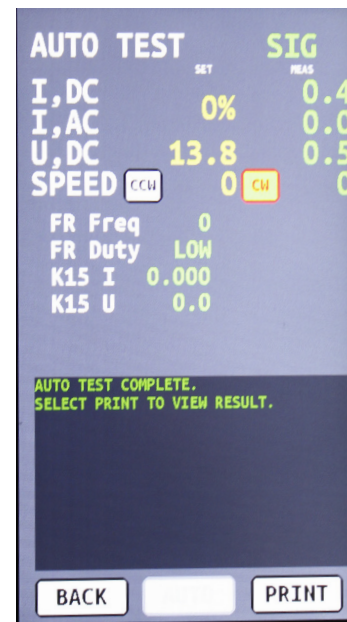
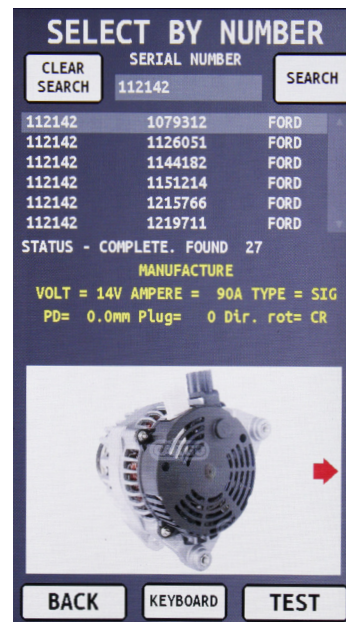
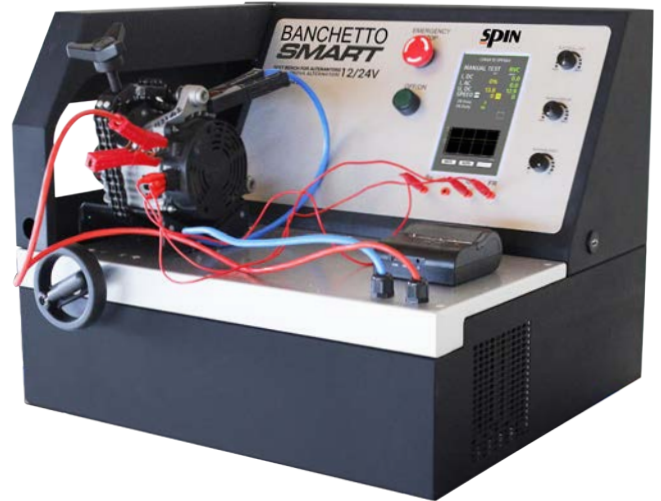

E



D

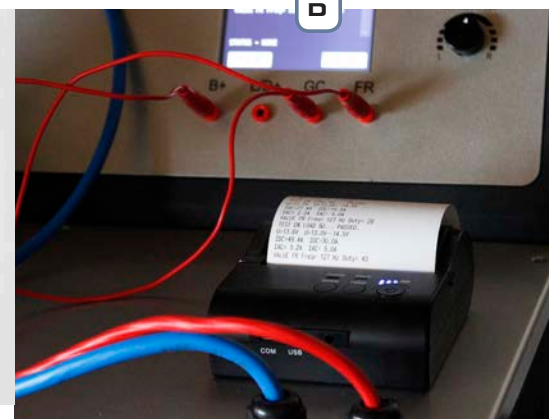



BANCHETTO JUNIOR

cod. 02.012.00 **400V**
cod. 02.012.03 **Inverter EVO**



BANCHETTO PROFI

cod. 02.004.15 **Inverter EVO**



BANCHETTO PLUS

cod. 02.004.14 **Inverter EVO**



D TRUCK

cod. 02.005.43 **D Truck EVO**



Cod. 02.004.02

> Differenza prezzo per **strumenti DIGITALI** per Banchetto "Plus"
> Price difference for **DIGITAL instruments** for Banchetto "Plus"

€ 420,00

Cod. 02.004.03

> **Freno meccanico** prova motorini su staffe per Banchetto "Plus"
> **Mechanical brake** for starter test on stirrup for Banchetto "Plus"

€ 1.180,00

Te-Sla Tronic
TESTER

Cod. 04.036.03

€ 1.048,00

> Fornito **DI SERIE** su versioni **Inverter EVO**
> **INCLUDED** in **Inverter EVO** versions



Cod. 04.036.00

> **Prova indotti** (per Banchetto Plus e Profi) 220V e 50Hz monofase
> **Armature tester** (for Banchetto Plus and Profi) 220V 50Hz single-phase

€ 440,00

DATI TECNICI TECHNICAL FEATURES	JUNIOR		PLUS	PROFI	D TRUCK
	BANCHETTO JUNIOR		BANCHETTO PLUS	BANCHETTO PROFI	D TRUCK
Modello Model	400V	Inverter EVO	Inverter EVO	Inverter EVO	Bancoprova D Truck EVO
Codice / Code	02.012.00	02.012.03	02.004.14	02.004.15	02.005.43
Basamento inferiore Lower basement	—	—	✓	✓	✓
Alimentazione Power Supply	400V three-phase	220V one-phase	400V three-phase	400V three-phase	400V three-phase
Motore / Motor	2 Hp	3 Hp	3Hp	5,5 Hp	10 Hp
Variatione continua (Inverter) Continuous Speed variation (Inverter)	One-speed motor	✓	✓	✓	✓
Reostato di carica Charging rheostat	200W (14V)	200W (14V)	490W (14V)	600W (14V)	850W (14V)
Strumentazione analogica Analogue Instruments	✓	✓	✓	—	—
Strumentazione digitale Digital instruments	—	—	on request	✓	✓
Con tester prova regolatori di tensione per alternatori TE-SLA TRONIC (04.036.03) With tester TE-SLA TRONIC (04.036.03) for the latest generation of voltage regulators for alternators	—	✓	✓	✓	✓
Prove effettuabili – Executable tests					
Alternatori / Alternators: 12-24 V	✓	✓	✓	✓	✓
Potenza massima alternatore (W) Max. alternator power (W)	1000	1200	1400	2000	3500
Prova indotti / Armature test	optional kit 04.036.00	optional kit 04.036.00	optional kit 04.036.00	optional kit 04.036.00	✓
Prova apparati elettrici 12-24V 12-24V Electric equipment test	✓	✓	✓	✓	✓
Prova motorini di avviamento 12-24V (a vuoto) 12-24V Starter test (no load)	✓	✓	✓	✓	✓
Prova motorini di avviamento con freno / Test of starters with brake	—	—	on request	✓	✓
Prova piastra diodi Diode plate test	—	—	✓	✓	✓
Prova isolamento campi e condensatori Field & condenser insulation test	—	—	✓	✓	✓
Cassetto per accessori e strumenti Drawer for accessories and tools	—	—	—	—	✓
Illuminazione piano di lavoro Worktop lighting	—	—	—	—	✓
Dimensioni (cm) / Dimensions	75x75x80	75x75x80	101x46x146	101x46x146	152x78x162
Peso (kg) / Weight (kg)	50	50	120	160	450
Prezzo di listino Price List	€ 2.460	€ 4.000	€ 5.620	€ 7.690	€ 15.500

CARATTERISTICHE TECNICHE
TECHNICAL FEATURES

Modello	RED STAR EVOLUTION		BLU STAR EVOLUTION		Model
	BASE	PROFI	BASE	PROFI	
Codice	02.007.04	02.007.09	02.008.02	02.008.04	Art.Nr.
Numero iniettori in prova	6	6	4	4	Nr. of injectors on test
Riconoscimento automat. del tipo di iniettore	✓	✓	manual	manual	Automatic recognition of the injector type
Vasca u/s con timer	3 lt	3 lt	2 lt a	2 lt	U/sonic tank with timer
Regolazione digitale giri, tempo di iniezione (programmi di prova)	✓	✓	manual <small>a freddo/cold</small>	manual <small>a freddo/cold</small>	Digital adjustment RPM, time injection (tests programs)
Pompa ad alta pressione (fino 11 bar)	✓ <small>4 programmi/programs</small>	✓	✓	✓	High Pressure pump (up to 11 bars)
Prove su iniettori SPI e MPI	✓	✓	✓	✓	Test on SPI & MPI injectors
Test e lavaggio iniettori GPL	✓	✓	✓	✓	Test and cleaning of LPG injectors
Carrello di servizio	?	✓	- cod. 05.088.40	✓	Service Trolley
Tanica liquid 5411	✓	✓	-	-	5411 (u/sonic) detergent canister
Tanica liquid WT1	-	-	✓	✓	WT1 (u/sonic) detergent canister
Liquido REM 40 T (cod. 02.000.41) per i test	✓	✓	✓	✓	REM 40 T (cod. 02.000.41) liquid for tests
Kit attacchi base	✓	✓	✓	✓	Base Equipment
043.6 (cod. 02.000.30) Kit per iniettori vetture giapponesi e coreane	-	✓	-	✓	043.6 (cod. 02.000.30) Kit adapters for Honda, Toyota, Hyundai, Mitsubishi
043.9 (cod. 02.000.32) Kit per iniettori Ford SPI e MPI	-	✓	-	✓	043.9 (cod. 02.000.32) Adapter kit for Ford SPI and MPI
043.11 (cod. 02.000.33) kit per iniettori Citroen, VW, Ford, Bosch monomotronic (Y10)	-	✓	-	✓	043.11 (cod. 02.000.33) kit for Citroen, VW, Ford, Bosch monomotronic (Y10) injectors
043.20 (cod. 02.000.35) Kit per iniettori Nissan	-	✓	-	✓	043.20 (cod. 02.000.35) Kit for Nissan injectors
043.24 (cod. 02.000.49) Kit per iniettori GDI-FSI-JTS	-	✓	-	✓	043.24 (cod. 02.000.49) Kit for GDI-FSI-JTS injectors
Cod. 02.000.57 Barra porta iniettori impianti GPL Landi Renzo	-	✓	-	✓	Cod. 02.000.57 Injector holding rail for LPG Landi Renzo
Cod. 02.000.60 Barra porta iniettori per impianti BRC	-	✓	-	✓	Cod. 02.000.60 Injector holding rail for BRC
Cod. 02.000.68 Barra universale per lavaggio iniettori GPL	-	✓	-	✓	Cod. 02.000.68 Injector holding rail for LPG
Prezzo di listino	€ 4.400,00	€ 5.614,00	€ 3.236,00	€ 4.645,00	Price List



Cod. 02.007.11
 > Carrello di servizio per Red Star
 > Service trolley for Red Star
Price on request



Cod. 05.088.40
 > Carrello 5 cassette per Blu Star
 > 5 drawers trolley for Blu Star
€ 199,00

RED STAR
 EVOLUTION

cod. 02.007.04
 cod. 02.007.09

BASE
PROFI



BLU STAR
 EVOLUTION

cod. 02.008.02
 cod. 02.008.04

BASE
PROFI



02.000.30	Art. 043.6 (incl. in Versione Profi/incl. in Profi Version) > Kit per iniettori giappon. Honda, Toyota, Hyundai, Mitsubishi > Kit adapters for Honda, Toyota, Hyundai, Mitsubishi	€ 130,00	02.000.43	5411 > Liquido per vasca ultrasuoni modello BLC > Liquid for ultrasonic cleaning tank BLC series	€ 59,00
02.000.32	Art. 043.9 (incl. in Versione Profi/incl. in Profi Version) > Kit per iniettori Ford SPI e MPI > Adapter kit for Ford SPI and MPI	€ 130,00	02.000.48	Art. 043.23 > Kit cavi e staffe per iniettori moto > Kit cables and stirrup for motorcycle injectors	€ 90,00
02.000.33	Art. 043.11 (incl. in Versione Profi/incl. in Profi Version) > Kit per / Kit for Citroen Xantia, Peugeot 406, Ford Mon deo, VW Golf e Bosch mono motronic (Y10)	€ 155,00	02.000.57	> Barra porta iniettori impianti GPL Landi Renzo, anche per Fiat Panda Natural Power > Injector holding rail for LPG Landi Renzo, also for Fiat Panda Natural Power (incl. in Versione Profi/incl. in Profi Version)	€ 130,00
02.000.35	Art. 043.20 (incl. in Versione Profi/incl. in Profi Version) > Kit per Nissan Primera, Micra, Serena > Kit adapters for Nissan Primera, Micra, Serena	€ 111,00	02.000.60	> Barra portainiettori impianti GPL BRC > Injector holding rail for LPG BRC (incl. in Versione Profi/incl. in Profi Version)	€ 130,00
02.000.49	Kit adattatori 043.24 (incl. in Versione Profi/incl. in Profi Version) > Sistemi di iniezione diretta benzina (GDI-FSI) > Kit for direct fuel injection systems GDI-FSI)	€ 225,00	02.000.59	> Kit porta iniettori METANO (Breda Bus) 4 pz > Injector holding kit for METHANE (Breda Bus) 4 pcs	€ 188,00
02.000.41	REM 40 > Liquido per banco lava iniettori tutti i modelli > Liquid canister for test bench	€ 59,00	02.000.68	> Barra universale per lavaggio iniettori GPL > Universal Injector holding rail for LPG (incl. in Versione Profi/incl. in Profi Version)	€ 113,00
02.000.42	WT1 > Liquido per vasca ultrasuoni Blu Star > Liquid for ultrasonic cleaning tank Blu Star.	€ 99,00			

NITROPOINT LINE

IT GENERATORI DI AZOTO CON SISTEMA A MEMBRANA PERMEABILE PER IL GONFIAGGIO DI PNEUMATICI DI AUTO, CAMION E AUTOBUS

- > Purezza minima: 95%
- > Filtri disoleatori e a carboni attivi interni
- > Scaricatore automatico di condensa
- > **A:** Deviatore aria-azoto
- > **B:** Uscita supplementare per serbatoio esterno
- > **C:** Manometro controllo pressione azoto in uscita
- > **D:** Strumento di controllo visivo intasamento filtri
- > **E:** Pistola di gonfiaggio/sgonfiaggio **Michelin** con venturimetro e tubo spiralato 8 mt
- > **F:** 20 tappi per azoto per pneumatici gonfiati ad azoto

EN NITROGEN GENERATORS WITH PERMEABLE MEMBRANE SYSTEM FOR INFLATING TYRES OF CARS, VANS AND BUSES

- > Minimum purity: 95%
- > Built-in, oil separating and active carbon filters
- > Automatic condensation overflow
- > **A:** Air-nitrogen switch
- > **B:** Extra outlet for external tank
- > **C:** Nitrogen outlet pressure gauge
- > **D:** Filter blockage check instrument
- > **E:** Inflating/deflating **Michelin** gun with Venturi meter and 8 mt spiral hose
- > **F:** 20 caps for tyres inflated with nitrogen



Accessori a richiesta / Optional Accessories

Cod. 03.000.14

- > Tappi per azoto per pneumatici gonfiati ad azoto. Confezione 100pz.
- > Kit of caps for tyres inflated with nitrogen, 100pcs.

€17,00

Cod. 03.006.01

- > Kit filtri di ricambio per Nitropoint 10 / Nitropoint 20, 3pz.
- > Kit of spare cartridges for Nitropoint 10 / Nitropoint 20, 3pcs.

€150,00

Cod. 03.006.02

- > Kit filtri di ricambio per Nitropoint 1 / Nitropoint 3, 2pz.
- > Kit of spare cartridges for Nitropoint 1 / Nitropoint 3, 2pcs

€96,00

Importante: specificare il numero di serie al momento dell'ordine
Important: please specify the serial number in the order

Corredo standard / Standard outfits



NITROPOINT LINE	NITROPOINT 1 Cod. 03.002.02	NITROPOINT 3 Cod. 03.002.04	NITROPOINT 10 Cod. 03.002.06	NITROPOINT 20 Cod. 03.002.22
Capacità flusso / flow capacity	1,2 Nm ³ /h 10 bar (145 PSI)	3,6 Nm ³ /h 10 bar (145 PSI)	12 Nm ³ /h 10 bar (181 PSI)	24 Nm ³ /h 10 bar (181 PSI)
Purezza / purity	Min. 95%	Min. 95%	Min. 95%	Min. 95%
Dimensioni / Dimensions	35 x 20 x 94,5 cm	35 x 20 x 94,5 cm	35 x 20 x 94,5 cm	35 x 20 x 94,5 cm
Peso / Weight	35 kg	37 kg	42 kg	45 kg
Prezzo di listino / Price List	€ 2.530,00	€ 3.540,00	€ 6.996,00	€ 9.328,00

NITRO@SERVICE LINE



MADE IN ITALY

Corredo standard / Standard outfits



IT GENERATORI DI AZOTO CON SISTEMA A MEMBRANA PERMEABILE PER IL GONFIAGGIO DI PNEUMATICI DI AUTO, CAMION E AUTOBUS

- > Purezza minima: 95%
- > Filtri disoleatori e a carboni attivi interni
- > **A:** Strumento di controllo visivo intasamento filtri
- > Scaricatore automatico di condensa
- > Deviatore aria-azoto
- > Manometro controllo pressione azoto in uscita
- > Uscita supplementare per serbatoio esterno
- > **Serbatoio da 90 kg incluso (modelli Nitro@service 1200/3600)**
- > **Con carrello: due ruote fisse e due girevoli**
- > **B:** Pistola di gonfiaggio/sgonfiaggio Michelin con venturimetro e tubo spiralato 8 mt
- > **C:** 20 tappi per azoto per pneumatici gonfiati ad azoto

EN NITROGEN GENERATORS WITH PERMEABLE MEMBRANE SYSTEM FOR INFLATING TYRES OF CARS, VANS AND BUSES

- > Minimum purity: 95%
- > Built-in, oil separating and active carbon filters
- > **A:** Filter blockage check instrument
- > Automatic condensation overflow
- > Air-nitrogen switch
- > Nitrogen outlet pressure gauge
- > Extra outlet for external tank
- > **90 lt tank included (by Nitro@service 1200 / 3600)**
- > **With trolley: 2 fixed wheels and 2 rotating wheels**
- > **B:** Inflating/deflating Michelin gun with Venturi meter and 8 mt spiral hose
- > **C:** 20 caps for tyres inflated with nitrogen

Accessori a richiesta / Optional Accessories

Cod. 03.000.14

- > Tappi per azoto per pneumatici gonfiati ad azoto. Confezione 100pz.
- > Kit of caps for tyres inflated with nitrogen, 100pcs.

€17,00

Cod. 03.006.01

- > Kit filtri di ricambio per Nitroservice 12000/24000, 3pz.
- > Kit of spare cartridges for Nitroservice 12000/24000, 3pcs.

€150,00

Cod. 03.006.02

- > Kit filtri di ricambio per Nitroservice 1200 / 3600, 2pz.
- > Kit of spare cartridges for Nitroservice 1200 / 3600, 2pcs

€96,00

Importante: specificare il numero di serie al momento dell'ordine
Important: please specify the serial number in the order

NITRO@SERVICE LINE	NITRO@SERVICE 1200 Cod. 03.002.40	NITRO@SERVICE 3600 Cod. 03.002.41	NITRO@SERVICE 12000 Cod. 03.002.42	NITRO@SERVICE 24000 Cod. 03.002.43
Capacità flusso / flow capacity	1,2 Nm ³ /h 10 bar (145 PSI)	3,6 Nm ³ /h 10 bar (145 PSI)	12 Nm ³ /h 10 bar (181 PSI)	24 Nm ³ /h 10 bar (181 PSI)
Purezza / purity	Min. 95%	Min. 95%	Min. 95%	Min. 95%
Serbatoio interno / Internal tank	90 lt (Nitro@service)	90 lt (Nitro@service)	Può lavorare senza serbatoio esterno Can work without external tank	Può lavorare senza serbatoio esterno Can work without external tank
Dimensioni / Dimensions	60 x 44 x 132 cm	60 x 44 x 132 cm	60 x 44 x 132 cm	60 x 44 x 132 cm
Peso / Weight	75 kg	75 kg	65 kg	70 kg
Prezzo di listino / Price List	€2.925,00	€4.000,00	€7.260,00	€9.590,00

HL 40 LX TOUCH

HL 40 LX Touch
Cod. 03.011.11

€ 1.800,00



> Centrafari elettronico ad alta precisione
> High precision electronic headlight tester

RICONOSCIMENTO AUTOMATICO DEL TIPO FARO

Grazie alla tecnologia di ultima generazione, il dispositivo è in grado di riconoscere automaticamente il tipo di faro che si sottoposto al test garantendo sempre la massima precisione del risultato. L'operatore non deve più selezionare il tipo di faro prima di procedere con il test.

SOFTWARE INTUITIVO

Abbiamo creato un software di immediata comprensione che non lascerà all'operatore nessun dubbio sull'utilizzo. Il centrafari dà il risultato sullo stato del faro in automatico (troppo alto/basso/sinistra/destra oppure OK) quindi non è più l'operatore che deve decidere se la posizione del faro è corretta

CONNESSIONE ETHERNET

Il dispositivo può essere collegato al PC per: Controllo remoto, Mandare i dati al PC, Assistenza tecnica in remoto. Se il dispositivo viene collegato a un ripetitore WIFI, questo può essere controllato completamente dallo smartphone utilizzando l'applicazione gratuita disponibile su tutti gli App Store

CARATTERISTICHE TECNICHE

- Adatto per fari tipo LED/Xenon e Alogeni
- Riconoscimento automatico del tipo faro
- Altezza minima operativa: 23 cm
- Altezza massima operativa: 146 cm
- Tipo di lente: LENTE OTTICA IN VETRO
- Luxometro interno ad alta precisione ± 0.01
- Display 4,3" Touch Screen a colori
- Sistema puntamento laser
- Visore a specchio
- Livella elettronica
- Lingue disponibili 10
- Interfaccia USB
- Interfaccia Ethernet
- Connessione con PC
- Controllo remoto da PC
- Assistenza tecnica in remoto
- Visore Laser VERDE (Opzionale)
- Sistema a rotaia (Opzionale)
- Luci di stato (Opzionale)
- Wi-Fi (con accessorio opzionale)
- Alimentazione: 2 x batterie 12V
- Peso: 35 Kg

AUTOMATIC RECOGNITION OF THE LIGHT

Thanks to latest generation technology, the device is able to recognize automatically the type of the light that is testing ensuring maximum accuracy of the result. The operator no longer has to choose the type of headlight to be tested

INTUITIVE SOFTWARE

We have created a user-friendly SW that, thanks to its graphic icons, leaves the customer no longer doubts.

The headlight gives the result on the status of the headlight automatically (too high / low / left / right or OK) so it is no longer the operator who has to decide if the position of the headlight is correct

ETHERNET CONNECTION

The device can be connected to a PC to make: Remote control, Sending data to PC, Remote technical service

If the device is connected to a WIFI repeater, this can be controlled from the smartphone using the appropriate free application

TECHNICAL FEATURES

- Suitable for LED / Xenon and Halogen lights
- Automatic recognition of the light type
- Min. operating height: 23 cm
- Max. operating height: 146 cm
- Lens type: OPTICAL GLASS LENS
- High precision internal luxmeter ± 0.01
- 4.3 "color touch screen display
- Laser pointing system
- Mirror visor
- Electronic level
- Available languages 10
- USB interface
- Ethernet interface
- PC connection for data storage and print
- Remote control from PC
- Remote technical service
- GREEN Laser visor (Optional)
- Rail system (Optional)
- Status lights (Optional)
- Wi-Fi (with additional accessory)
- Power supply: 2 x 12V batteries
- Weight: 35 Kg

14/04/2020

12:48

SETTINGS

TEST

MODEL	HL40TOUCH
FW VERSION	1.2 30.06.2020
SERIAL NUMBER	10289/20
BATTERY LEVEL	70%



NAME:	
ADDRESS:	
VAT NR:	
PHONE:	



Cod. 03.011.08

HL30 TRONIC/2

€ 980,00

- Registrazione manuale della corretta posizione di faro, anabbagliante, abbagliante e antinebbia (A)
- Registrazione automatica dell'intensità luminosa di ogni tipo di faro (A)
- Software multilingua (A)
- Uscita USB per collegamento a PC con invio di tutti i dati registrati e possibilità di stampa attraverso il PC (B)
- Registra targa del veicolo, nome dell'officina, inclinazione utilizzata e altezza del faro
- Altezza della colonna 1700mm
- Versione standard con visore a specchio e centratore laser (C)
- Pannello regolabile, 0÷4%
- Può controllare sia i fari Europei che quelli di tipo Americano e Giapponese (E)

- Manual adjustment of the correct position for all types of headlight, lower beam, upper beam and fog lights (A)
- Automatic recording of light intensity of all types of headlight (A)
- Multilingual software (A)
- USB port for connection to PC with forwarding of recorded data and print option via PC (B)
- Records vehicle number plate, name of garage, used inclination and headlight height
- Height of column: 1700 mm
- Standard version with mirror visor and central laser pointer (C)
- Adjustable panel, 0÷4% (D)
- Can be used on both European and American/Japanese headlight types (E)

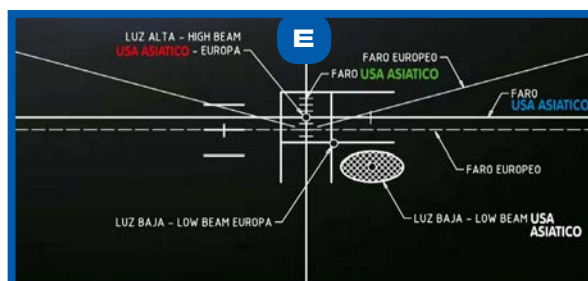
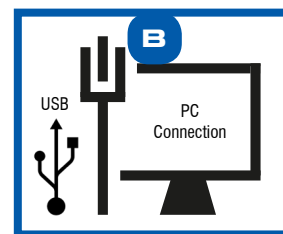

Cod. 03.011.01

HL26 DL1

€ 670,00

- Centrafari meccanico
- Luxmetro digitale (A)
- Visore a specchio (B)
- Asta metrica fissa con molla di richiamo (L=1700 mm)
- Base fissa
- Pannello regolabile, 0÷4% (C)
- Lente piano convessa ø200
- Centratore laser (D)

- Mechanical headlight beam tester
- Digital luxmeter (A)
- Mirror visor (B)
- Locking clamp and graduate scale with spring inside, L=1700mm
- Fixed base
- Adjustable panel, 0÷4% (C)
- Semi optical lens ø200
- Central laser pointer (D)

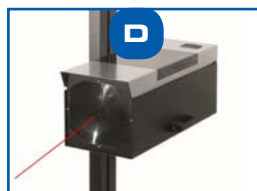
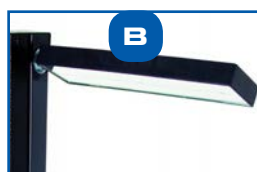
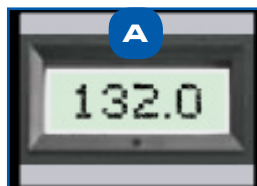

Cod. 03.011.00

HL26 D

€ 580,00

- > Come HL26DL1, ma senza laser nella lente
- > As HL26DL1, but without lens laser

Cod. 03.011.02

HL26DL2

€ 798,00

- > Come HL26DL1, ma con allineamento a fascio laser anziché a specchio (E)
- > As HL26DL1, but with upper laser alignment instead of mirror visor (E)



N.B. Il modello 03.011.07 (linea touch) è disponibili a richiesta
Note: 03.011.07 model is available on request

Cod. 03.011.05
HL19D
€ 495,00

- Centrafari meccanico
 - **A:** Luxmetro digitale
 - **B:** Visore a specchio
 - **C:** Asta di scorrimento (L=1660 mm) con pinza (senza molla di richiamo)
 - **D:** Pannello regolabile (0÷4%)
 - Lente piano convessa ø200
 - **E:** Asta fissa
-
- Mechanical headlight beam tester
 - **A:** Digital luxmeter
 - **B:** Mirror visor
 - **C:** Sliding system L=1660mm with locking clamp (no spring inside)
 - **D:** Adjustable panel (0÷4%)
 - Semi optical lens ø200
 - **E:** Fixed column

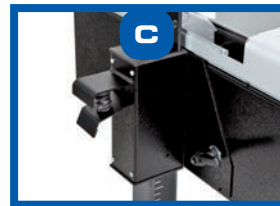
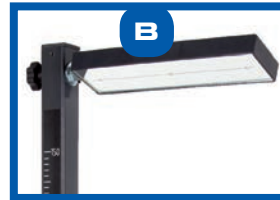
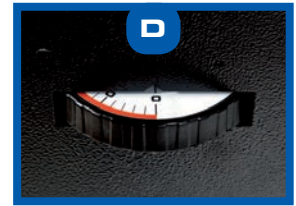
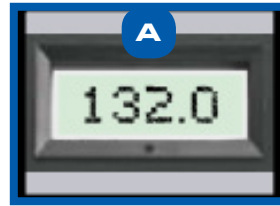

Caratteristiche tecniche Technical features	HL19 D Cod. 03.011.05	HL26 D LX Cod. 03.011.00	HL26 DL1 LX Cod. 03.011.01	HL26 DL2 LX Cod. 03.011.02	HL30 TRONIC/2 Cod. 03.011.08
Luxmetro digitale Digital luxmeter	✓	✓	✓	✓	—
Luxmetro elettronico Electronic luxmeter	—	—	—	—	✓
Software multilingua Multilingual software	—	—	—	—	✓
Uscita usb per scarico dati a pc USB output for data download	—	—	—	—	✓
Asta metrica fissa L=1660mm Sliding system L=1660mm	✓	—	—	—	—
Asta metrica fissa con molla di richiamo Sliding system with locking clamp	—	✓	✓	✓	✓
Allineamento a specchio Mirror visor	✓	✓	✓	—	✓
Puntatore laser interno Central laser pointer	—	—	✓	✓	✓
Allineamento a fascio laser Upper laser alignment	—	—	—	✓	—
Lente piano convessa ø200 Semi optical lens ø200	✓	✓	✓	✓	✓
Pannello regolabile (0-4%) Adjustable panel (0-4%)	✓	✓	✓	✓	—
Pannello per vetture USA/Jap/EU USA/Jap/EU vehicles panel	—	—	—	—	✓
Prezzi di listino List prices	€ 495,00	€ 580,00	€ 670,00	€ 798,00	€ 980,00
Accessori a richiesta / Optional Accessories					
Asta metrica in 3 pezzi per riduzione ingombro Sliding system (3 parts) for volume reduction	€ 36,00	✓	—	—	—
Copertina antipolvere Anti-dust cover	€ 28,00	✓	✓	✓	✓
Allineamento a fascio laser (al posto dello specchio) Upper laser alignment (instead of mirror visor)	€ 132,00	✓	✓	✓	✓
				incluso di serie standard included	

Tyre LIFTER 70

Tyre Lifter 70
Cod. 05.084.27

€ 1.890,00

BATTERY-POWERED WHEEL LIFTER

The battery-powered TYRE LIFTER 70 is designed to move the wheels of cars and lightweight commercial vehicles conveniently and safely.

It has absolutely unique features in the world of wheel lifters, making for an ease of operation which has no equal in rival products.

In fact there are no support forks on the ground in front of the lifter so the wheel can be easily moved in front of the assembly point without being obstructed.

The wheel lifter has an effective load capacity of 70 kg.

Lifting precision means it can stop exactly where the mechanic needs to fit the wheel, like having a strong, meticulous colleague to help you.

TECHNICAL FEATURES

- Max load lifter: 70 kg
- Max. operating height: 1600 mm
- Battery: 24 V
- Height: 1700 mm
- Width: 950 mm
- Weight: kg 98
- Note: battery charger included



LOW LIFT LINE

Batteries powered fully autonomous



This lifter is without any support forks on the ground in the front. Thanks to this characteristic, it can be used with all kind of lifts, even those with a base and with parts fixed to the ground.

Suggested for:

- Cars and vans car dealers
- Tyre shops specialists
- Quick service workshops

BRAKE MATE

BRAKE BLEED

NEW!
2021

BRAKE MATE MK2

Cod. 03.036.35

€ 1.035,00

BRAKE BLEEDING DEVICE

MK2 is equipped with 2 pumps, one for the waste liquid recovery and one for the insertion of the new liquid. The cabinet is equipped with a special compartment for storing the accessories. It has a large rear space for the used oil tank (5 lt), the 2 recovery tanks, a 20 lt new oil tank (also of common type). There is also space for the box with new caps cod. 03.036.28 (optional).



TECHNICAL FEATURES

- Compatible liquids: Pre DOT - DOT2 - DOT3 - DOT4 - DOT5 - DOT5.1 - DOT6 - DOT6.1 - LHM
- New fluid tank capacity: 5 lt standard (optional tank up to 25 lt)
- Waste fluid tank capacity: 5 lt
- Operating pressure: 0 - 4 bar
- Pump capacity: 1 lt/min
- Delivery hose length: 7.5 m
- Suction hose length: 7.5 m
- Power supply cable length: 3 m
- Power supply: 230V 50-60 Hz
- Noise: <70 dB (A)
- Dimensions: 67x54x90 cm
- Weight: 35 Kg



MADE IN ITALY

Cod. 03.036.28

€ 202,00



ADAPTER KIT FOR THE BRAKE BLEEDER

- Suitable for most pressure brake bleeders
- European cap adapter, multi vehicle caps, American adapter (gm), BMW/Audi, Nissan, Mazda & Honda
- Universal adapters and manufacturer specific caps
- Adapters fit 90% of current master cylinder reservoirs

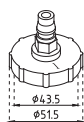

BC-01

CHRYSLER, DODGE, JEEP, PLYMOUTH

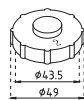

BC-02

CHRYSLER, DODGE, JEEP, PLYMOUTH

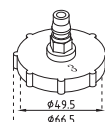

BC-03

MOST LATE MODEL GM CARS (BUICK, CADILLAC, CHEVROLET, GMC, HUMMER, OLDSMOBILE, PONTIAC) SOME MAZDA

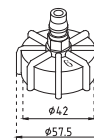

BC-06

MOST EUROPEAN CARS (ALFA ROMEO, AUDI, BMW, JAGUAR, LAND ROVER, MERCEDES, PEUGEOT, PORSCHE, RENAULT, SAAB, VW, VOLVO), CHRYSLER CROSSFIRE, DAEWOO, LATE MODEL FORD, KIA, SOME MAZDA, AND MINI

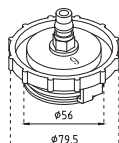

BC-09

HONDA ACCORD CARS

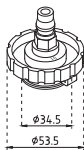

BC-10

NISSAN CARS

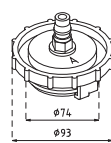

BC-12

HONDA

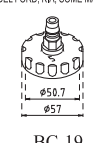

BC-19

ALL HYUNDAI, MITSUBISHI, NISSAN, AND SUBARU, SOME CHRYSLER/DODGE, SOME FORD/LINCOLN



BC-21

TOYOTA & LEXUS

Cod. 02.003.09

> **Tornio rettifica dischi freni**

Il kit include tornio per dischi 220V 50Hz, unità di movimento e 13 accessori per operare su vetture e veicoli commerciali europei ed asiatici.

> **Brake disc grinding lathe**

The kit includes the lathe for discs 220V 50Hz, the moving unit and 13 accessories to work on European and Asiatic cars and commercial vehicles.

€ 3.800,00

CARATTERISTICHE TECNICHE

- Spessore massimo del disco: 39mm
- Profondità di taglio massima: 0,8mm per tagliente
- Altezza di lavoro: regolabile da 800 a 1200mm
- Velocità di taglio: 8,5mm/al minuto
- Numero di giri/minuto: 98
- D max. disco in lavorazione: 350mm

Risultati della rettifica:

- Deformazione del disco del freno: <20µm
- Variazione di spessore: <20µm
- Rugosità di superficie: <1µm
- Voltaggio: 220V/50Hz
- Amperaggio: 6,8A

TECHNICAL FEATURES

- Maximum disc thickness: 39mm
- Maximum cutting depth: 0,8mm per cutting edge
- Working height: adjustable from 800 to 1200mm
- Cutting speed: 8.5mm per minute
- RPM: 98rpm
- D max. disc: 350mm

Aligning results:

- Brake disc wobbling: <20µm
- Irregular thickness: <20µm
- Surface roughness: <µm
- Voltage: 220V/50Hz
- Current: 6.8A



max 1200mm



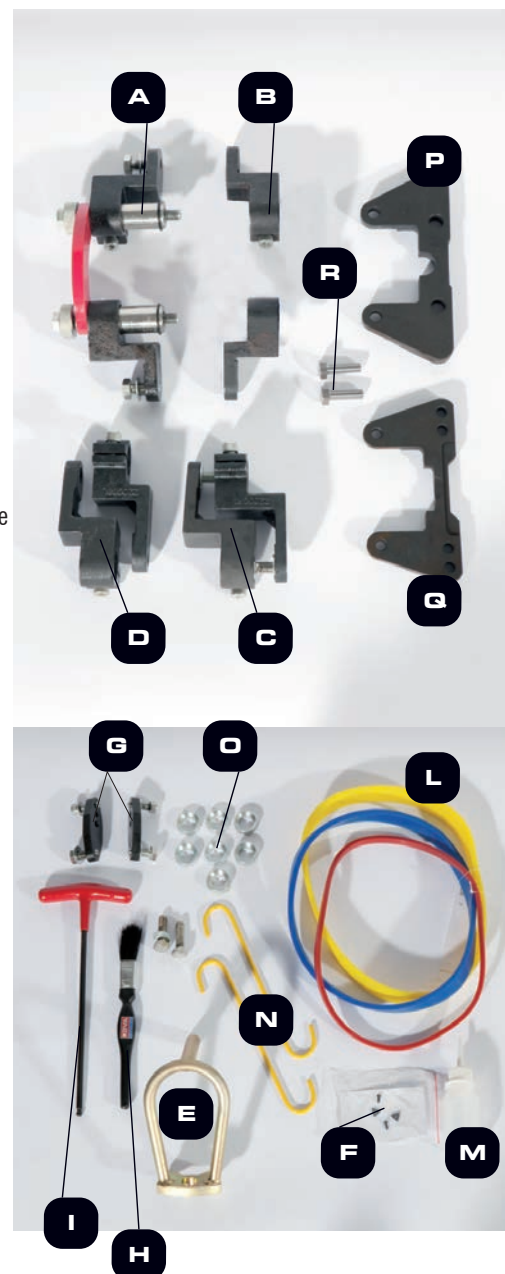
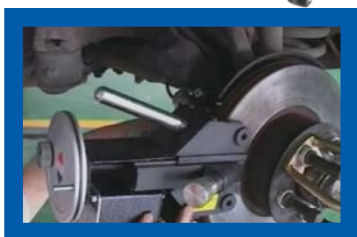

min 800mm



Corredo standard / Standard outfits





801000	Tornio per dischi 220V 50Hz 220v 50Hz Disc lathe	1 pz / pc	803104 H	Spazzola Brush	1 pz / pc
802000	Unità di movimento 220V 50Hz 220V 50Hz Driving unit	1 pz / pc	803102 I	Chiave esagonale M6 Hexagonal key M6	1 pz / pc
803001 A	Guida universale con filettatura (set) Universal slide with thread (set)	1 pz / pc	803111 L	Gomma antirumore piccola per dischi Small silencer bank for discs	1 pz / pc
803002 B	Set 2 guide Set of 2 slides	1 pz / pc	803105 M	Olio Oil	1 pz / pc
803011 C	Staffa estensione per 803001 Extension brackets for 803001	1 pz / pc	803106 N	Ganci a S S-hooks	2 pz/pcs
803012 D	Staffa estensione per 803002 Extension brackets for 803002	1 pz / pc	803103 O	Spessori Shims wash	7 pz/pcs
803017 E	Adattatore movimento grande Larger drive adapter	1 pz / pc	02.003.06 P	Staffa speciale per Opel Special bracket for Opell	1 pz / pc
803013 F	Punta (tre lati) Bit (three side)	2 pz/pcs	02.003.07 Q	Staffa speciale per Toyota/Nissan Special bracket for Toyota/Nissan	1 pz / pc
808001 G	Piccole placche di montaggio Small mounting plates	1 pz / pc	02.003.08 R	Kit bulloni per VW Golf/Ford Focus Kit bolts for VW Golf/Ford Focus	1 pz / pc

HEATING INDUCTORS

CARATTERISTICHE TECNICHE	 Cod. 05.066.11	 Cod. 05.066.13	 Cod. 05.066.27	 Cod. 05.066.28
Modello/Model	Hi 3.7	Hi 5.5	Hi 13	Hi 18
	€ 3.450,00	€ 5.600,00	€ 9.300,00	€ 10.000,00
Max. power	3.7 Kw 16A	5 Kw 16A	13 Kw 16A	18 Kw 32A
Power supply	230V single phase	400V 3ph	400V 3ph	400V 3ph
Frequency range (kHz)	15 ÷ 30 kHz	15 ÷ 30 kHz	15 ÷ 30 kHz	15 ÷ 30 kHz
Duty cycles	15'	30'	45'	60'
Inductor cable length	4 mt	4 mt	4 mt	4 mt
Power supply cable length	9 mt	9 mt	9 mt	9 mt
Tank capacity	20 lt	20 lt	20 lt	20 lt
Cooling system	✓	✓	✓	✓
Keyboard	✓	✓	✓	✓
Electrical connection	IEC 60309	IEC 60309	IEC 60309	IEC 60309
Dimensions, cm	80 x 80 x 115	80 x 80 x 118	80 x 83 x 135	80 x 83 x 135
Weight (kg)	50 kg	67 kg	120 kg	130 kg
APPLICATION				
Car Body Shops	x	—	—	—
Tyre Shops	xxx	—	—	—
Car Mechanics	xxx	xx	—	—
Agri	xx	xxx	xxx	x
Trucks/earth moving vehicles	—	x	xxx	xxx
Maintenance/Industry/Nautic	—	—	xxx	xxx

Accessori a richiesta /Optional accessories

Hi3.7 / Hi5.5

	Cod. 05.066.14 Puntale laterale Lateral operating tool	€ 360,00
	Cod. 05.066.15 Puntale verticale Vertical operating tool	€ 360,00
	Cod. 05.066.16 Ferrite per puntale laterale Ferrite for lateral operating tool	€ 42,00
	Cod. 05.066.17 Ferrite per puntale verticale Ferrite for vertical operating tool	€ 42,00

Hi13

	Cod. 05.066.19 € 360,00	Cod. 05.066.28.R1 € 545,00
	Cod. 05.066.20 € 360,00	Cod. 05.066.28.R2 € 545,00
	Cod. 05.066.21 € 180,00	Cod. 05.066.28.R3 € 225,00
	Cod. 05.066.22 € 96,00	Cod. 05.066.28.R4 € 138,00

Hi18

KOMPACT 3000 PRO

KOMPACT 3000 PRO
Cod. 03.031.30

€ 1.460,00

PNEUMATIC SPRING COMPRESSOR

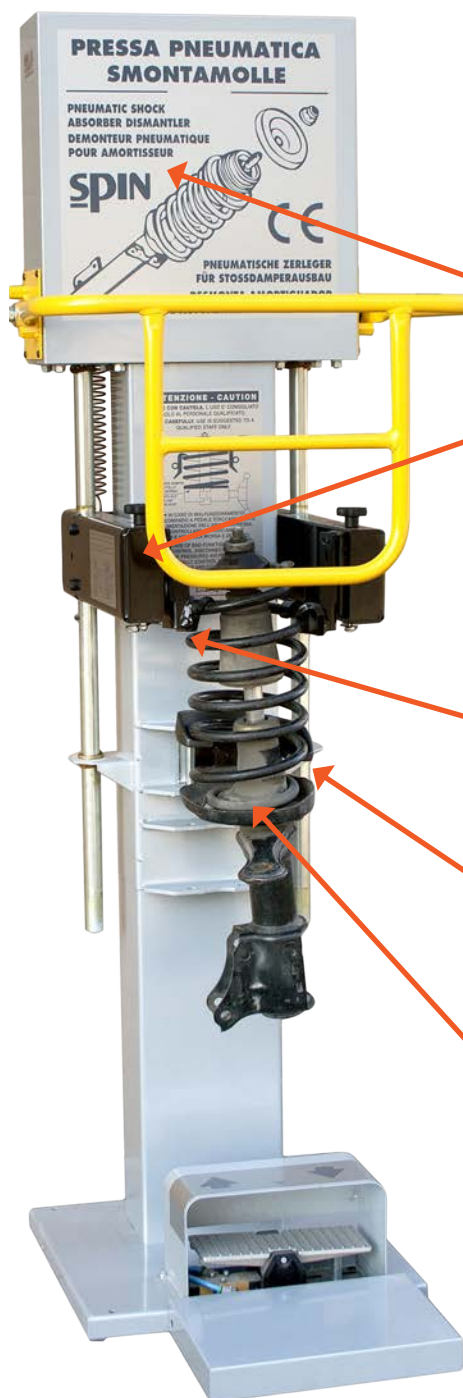

- 1600kg at 10 bars;
- 2 pneumatic pistons
- Pistons stroke increased for shock absorbers with fewer coils
- Interconnected arms for greater safety in use
- Boxytype and ribbed cabinet in sheet steel
- Pneumatic pedal

• 2 pneumatic pistons

• Interconnected arms for greater safety in use

• Double swinging hooks

• Pistons stroke increased for shock absorbers with fewer coils

• The machine adjusts to the spring, not vice versa

• Oscillating flange holder support (+/- 6°) for non-adjustable shock absorbers (B)

STANDARD EQUIPMENT:

- A:** 3 flanges in spheroidal cast-iron (Ø 85/125, Ø 125/150, Ø 150/195)
- B:** Flange-holder oscillating support (±6°) for non regular shock absorbers
- C:** Spacer for conical springs
- D:** vice
- E:** Pair of oscillating double hooks
- Dimensions: 65x60x156cm
- Weight: 70 kg

MADE IN ITALY

STANDARD OUTFIT



OPTIONAL ACCESSORIES



>Kit hooks for small diameter spring (Japanese vehicles, Korean vehicles, Smart, etc)

€ 130,00

03.031.15



>Flanges Ø240 for suspensions of all-terrain vehicles/suv

€ 77,90

03.031.16



>Special flanges for dismantling shock-absorbers Mercedes Classe A and C (2pcs)

€ 250,00

03.031.17



>Special flask for dismantling shock-absorbers Porsche Cayenne and VW Tuareg

€ 129,00

03.031.18

EXP
ERT
ISE



Validità

1/10/21 - 31/3/22

CATALOGUE

2021

SPIN s.r.l.

Via Casalecchio 35/G
47924 Rimini (RN) Italy
Tel. +39 0541.730777
Fax +39 0541.731315
e-mail: info@spinsrl.it
www.spinsrl.it

COMPANY WITH
QUALITY SYSTEM
CERTIFIED BY DNV GL
= ISO 9001 =

Stazioni A/C
Accessori aria condizionata
Sanificazione
ATF Lavacambi automatici
Lavaradiatori
Decarbonizzatori
Banco prova alternatori
Sollevatore ruote
Spurgafreni
Banco prova pulizia iniettori
Pressa smontamolle

RIVENDITORE